

# NTF6P02, NVF6P02

## Power MOSFET -10 Amps, -20 Volts

### P-Channel SOT-223

#### Features

- Low  $R_{DS(on)}$
- Logic Level Gate Drive
- Diode Exhibits High Speed, Soft Recovery
- Avalanche Energy Specified
- NVF Prefix for Automotive and Other Applications Requiring Unique Site and Control Change Requirements; AEC-Q101 Qualified and PPAP Capable\*
- These Devices are Pb-Free and are RoHS Compliant

#### Typical Applications

- Power Management in Portables and Battery-Powered Products, i.e.: Cellular and Cordless Telephones and PCMCIA Cards

#### MAXIMUM RATINGS ( $T_J = 25^\circ\text{C}$ unless otherwise noted)

Rating	Symbol	Value	Unit
Drain-to-Source Voltage	$V_{DSS}$	-20	Vdc
Gate-to-Source Voltage	$V_{GS}$	$\pm 8.0$	Vdc
Drain Current (Note 1)			
– Continuous @ $T_A = 25^\circ\text{C}$	$I_D$	-10	Adc
– Continuous @ $T_A = 70^\circ\text{C}$	$I_D$	-8.4	
– Single Pulse ( $t_p = 10 \mu\text{s}$ )	$I_{DM}$	-35	Apk
Total Power Dissipation @ $T_A = 25^\circ\text{C}$	$P_D$	8.3	W
Operating and Storage Temperature Range	$T_J, T_{stg}$	-55 to +150	$^\circ\text{C}$
Single Pulse Drain-to-Source Avalanche Energy – Starting $T_J = 25^\circ\text{C}$ ( $V_{DD} = -20 \text{ Vdc}$ , $V_{GS} = -5.0 \text{ Vdc}$ , $I_{L(pk)} = -10 \text{ A}$ , $L = 3.0 \text{ mH}$ , $R_G = 25\Omega$ )	$E_{AS}$	150	mJ
Thermal Resistance			$^\circ\text{C/W}$
– Junction to Lead (Note 1)	$R_{\theta JL}$	15	
– Junction to Ambient (Note 2)	$R_{\theta JA}$	71.4	
– Junction to Ambient (Note 3)	$R_{\theta JA}$	160	
Maximum Lead Temperature for Soldering Purposes, 1/8" from case for 10 seconds	$T_L$	260	$^\circ\text{C}$

Stresses exceeding Maximum Ratings may damage the device. Maximum Ratings are stress ratings only. Functional operation above the Recommended Operating Conditions is not implied. Extended exposure to stresses above the Recommended Operating Conditions may affect device reliability.

1. Steady State.
2. When surface mounted to an FR4 board using 1" pad size, (Cu. Area 1.127 sq in), Steady State.
3. When surface mounted to an FR4 board using minimum recommended pad size, (Cu. Area 0.412 sq in), Steady State.



ON Semiconductor®

<http://onsemi.com>

**-10 AMPERES  
-20 VOLTS**

**$R_{DS(on)} = 44 \text{ m}\Omega$  (Typ.)**

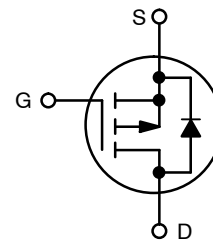

P-Channel MOSFET

#### MARKING DIAGRAM & PIN ASSIGNMENT

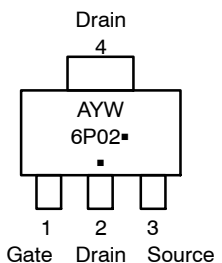

A = Assembly Location  
Y = Year  
W = Work Week  
6P02 = Specific Device Code  
▪ = Pb-Free Package  
(Note: Microdot may be in either location)

#### ORDERING INFORMATION

Device	Package	Shipping†
NTF6P02T3G	SOT-223 (Pb-Free)	4000 / Tape & Reel
NVF6P02T3G*	SOT-223 (Pb-Free)	4000 / Tape & Reel

†For information on tape and reel specifications, including part orientation and tape sizes, please refer to our Tape and Reel Packaging Specifications Brochure, BRD8011/D.

# NTF6P02, NVF6P02

## ELECTRICAL CHARACTERISTICS (T<sub>J</sub> = 25°C unless otherwise noted)

Characteristic	Symbol	Min	Typ	Max	Unit
----------------	--------	-----	-----	-----	------

### OFF CHARACTERISTICS

Drain-to-Source Breakdown Voltage (Note 4) (V <sub>GS</sub> = 0 Vdc, I <sub>D</sub> = -250 μAdc) Temperature Coefficient (Positive)	V <sub>(BR)DSS</sub>	-20 -	-25 -11	- -	Vdc mV/°C
Zero Gate Voltage Drain Current (V <sub>DS</sub> = -20 Vdc, V <sub>GS</sub> = 0 Vdc) (V <sub>DS</sub> = -20 Vdc, V <sub>GS</sub> = 0 Vdc, T <sub>J</sub> = 125°C)	I <sub>DSS</sub>	- -	- -	-1.0 -10	μAdc
Gate-Body Leakage Current (V <sub>GS</sub> = ± 8.0 Vdc, V <sub>DS</sub> = 0 Vdc)	I <sub>GSS</sub>	-	-	± 100	nAdc

### ON CHARACTERISTICS (Note 4)

Gate Threshold Voltage (Note 4) (V <sub>DS</sub> = V <sub>GS</sub> , I <sub>D</sub> = -250 μAdc) Threshold Temperature Coefficient (Negative)	V <sub>GS(th)</sub>	-0.4 -	-0.7 2.6	-1.0 -	Vdc mV/°C
Static Drain-to-Source On-Resistance (Note 4) (V <sub>GS</sub> = -4.5 Vdc, I <sub>D</sub> = -6.0 Adc) (V <sub>GS</sub> = -2.5 Vdc, I <sub>D</sub> = -4.0 Adc) (V <sub>GS</sub> = -2.5 Vdc, I <sub>D</sub> = -3.0 Adc)	R <sub>DS(on)</sub>	- - -	44 57 57	50 70 -	mΩ
Forward Transconductance (Note 4) (V <sub>DS</sub> = -10 Vdc, I <sub>D</sub> = -6.0 Adc)	g <sub>fs</sub>	-	12	-	Mhos

### DYNAMIC CHARACTERISTICS

Input Capacitance	(V <sub>DS</sub> = -16 Vdc, V <sub>GS</sub> = 0 V, f = 1.0 MHz)	C <sub>iss</sub>	-	900	1200	pF
Output Capacitance		C <sub>oss</sub>	-	350	500	
Transfer Capacitance		C <sub>rss</sub>	-	90	150	
Input Capacitance	(V <sub>DS</sub> = -10 Vdc, V <sub>GS</sub> = 0 V, f = 1.0 MHz)	C <sub>iss</sub>	-	940	-	pF
Output Capacitance		C <sub>oss</sub>	-	410	-	
Transfer Capacitance		C <sub>rss</sub>	-	110	-	

### SWITCHING CHARACTERISTICS (Note 5)

Turn-On Delay Time	(V <sub>DD</sub> = -5.0 Vdc, I <sub>D</sub> = -1.0 Adc, V <sub>GS</sub> = -4.5 Vdc, R <sub>G</sub> = 6.0 Ω)	t <sub>d(on)</sub>	-	7.0	12	ns
Rise Time		t <sub>r</sub>	-	25	45	
Turn-Off Delay Time		t <sub>d(off)</sub>	-	75	125	
Fall Time		t <sub>f</sub>	-	50	85	
Turn-On Delay Time	(V <sub>DD</sub> = -16 Vdc, I <sub>D</sub> = -6.0 Adc, V <sub>GS</sub> = -4.5 Vdc, R <sub>G</sub> = 2.5 Ω)	t <sub>d(on)</sub>	-	8.0	-	ns
Rise Time		t <sub>r</sub>	-	30	-	
Turn-Off Delay Time		t <sub>d(off)</sub>	-	60	-	
Fall Time		t <sub>f</sub>	-	60	-	
Gate Charge	(V <sub>DS</sub> = -16 Vdc, I <sub>D</sub> = -6.0 Adc, V <sub>GS</sub> = -4.5 Vdc) (Note 4)	Q <sub>T</sub>	-	15	20	nC
		Q <sub>gs</sub>	-	1.7	-	
		Q <sub>gd</sub>	-	6.0	-	

### SOURCE-DRAIN DIODE CHARACTERISTICS

Forward On-Voltage	(I <sub>S</sub> = -3.0 Adc, V <sub>GS</sub> = 0 Vdc) (Note 4) (I <sub>S</sub> = -2.1 Adc, V <sub>GS</sub> = 0 Vdc) (I <sub>S</sub> = -3.0 Adc, V <sub>GS</sub> = 0 Vdc, T <sub>J</sub> = 125°C)	V <sub>SD</sub>	- - -	-0.82 -0.74 -0.68	-1.2 - -	Vdc
Reverse Recovery Time	(I <sub>S</sub> = -3.0 Adc, V <sub>GS</sub> = 0 Vdc, dI <sub>S</sub> /dt = 100 A/μs) (Note 4)	t <sub>rr</sub>	-	42	-	ns
		t <sub>a</sub>	-	17	-	
		t <sub>b</sub>	-	25	-	
Reverse Recovery Stored Charge		Q <sub>RR</sub>	-	0.036	-	μC

4. Pulse Test: Pulse Width ≤ 300 μs, Duty Cycle ≤ 2.0%.
5. Switching characteristics are independent of operating junction temperatures.

TYPICAL ELECTRICAL CHARACTERISTICS

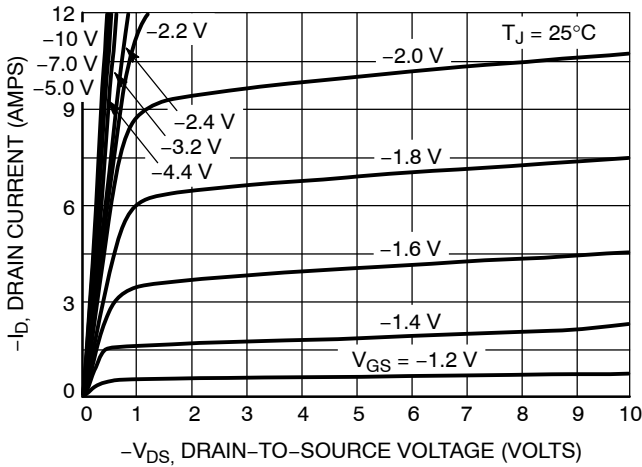

Figure 1. On-Region Characteristics

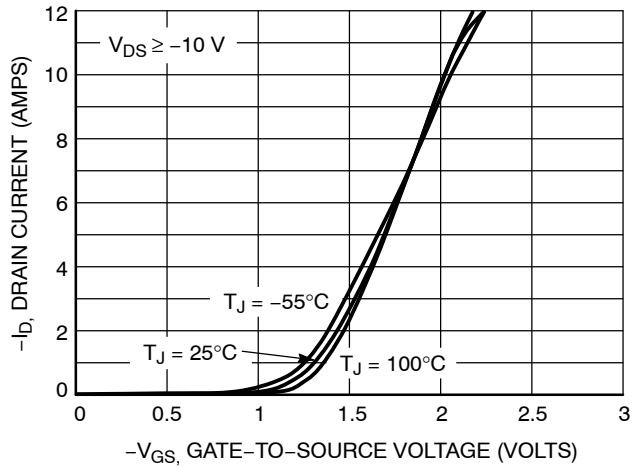

Figure 2. Transfer Characteristics

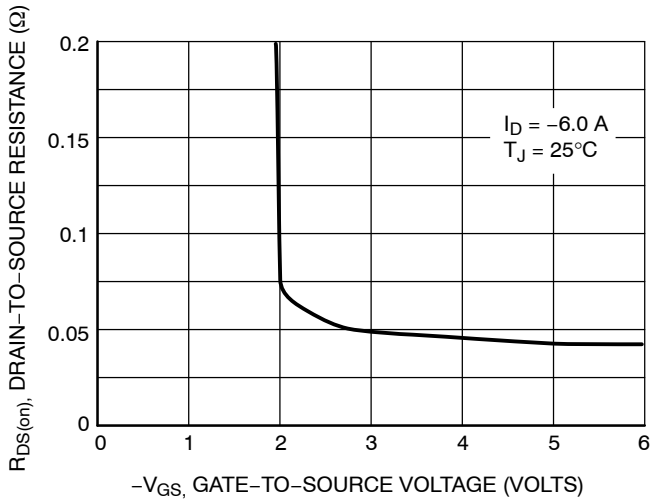

Figure 3. On-Resistance versus Gate-to-Source Voltage

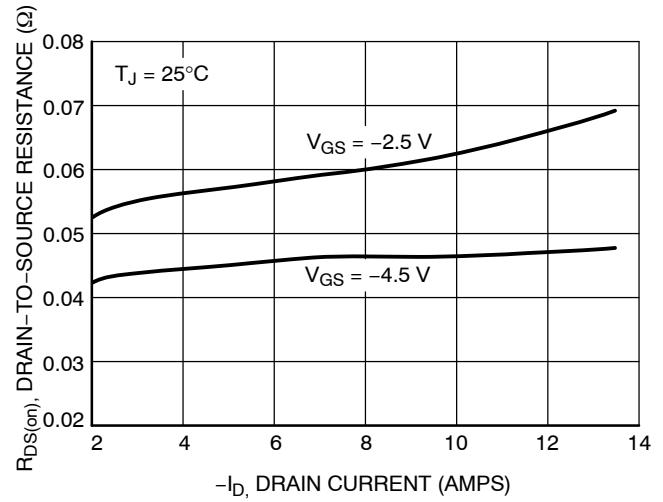

Figure 4. On-Resistance versus Drain Current and Gate Voltage

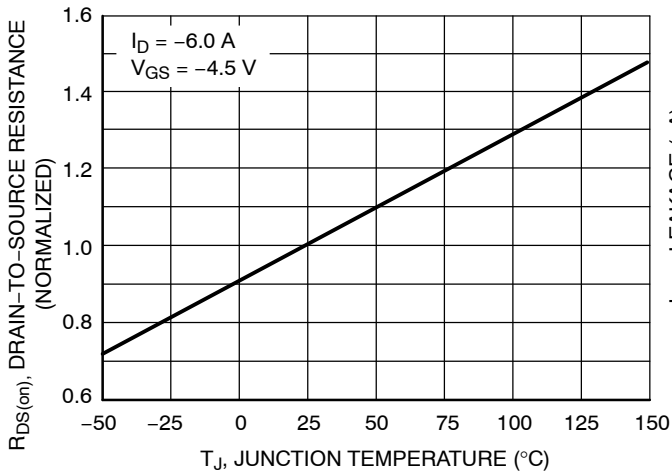

Figure 5. On-Resistance Variation with Temperature

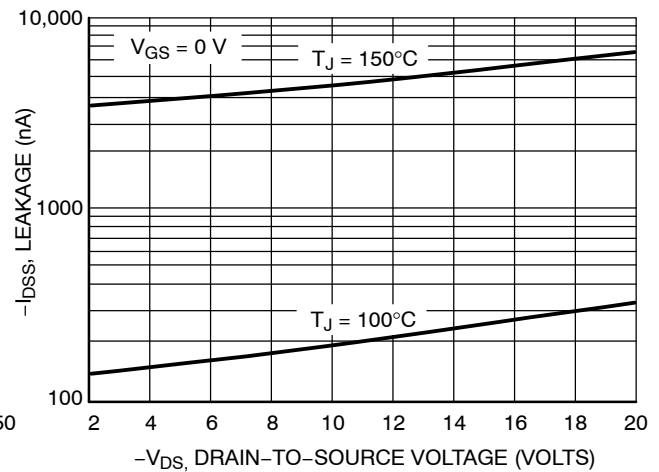

Figure 6. Drain-to-Source Leakage Current versus Voltage

TYPICAL ELECTRICAL CHARACTERISTICS

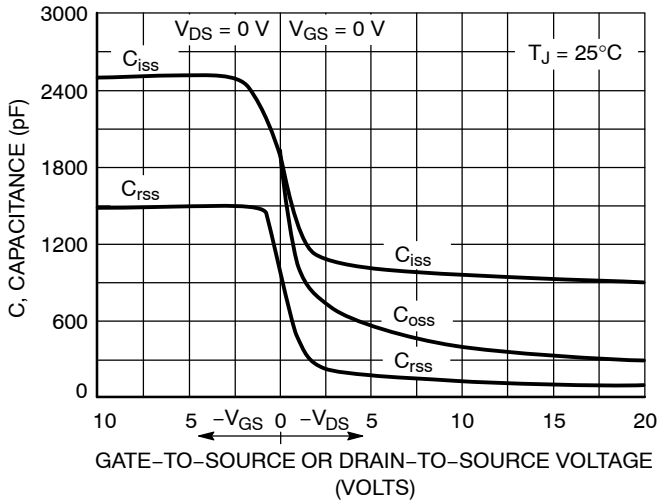

Figure 7. Capacitance Variation

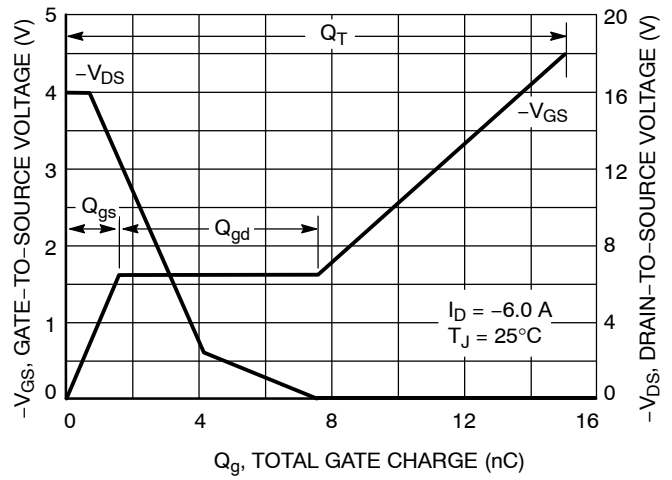

Figure 8. Gate-to-Source and Drain-to-Source Voltage versus Total Charge

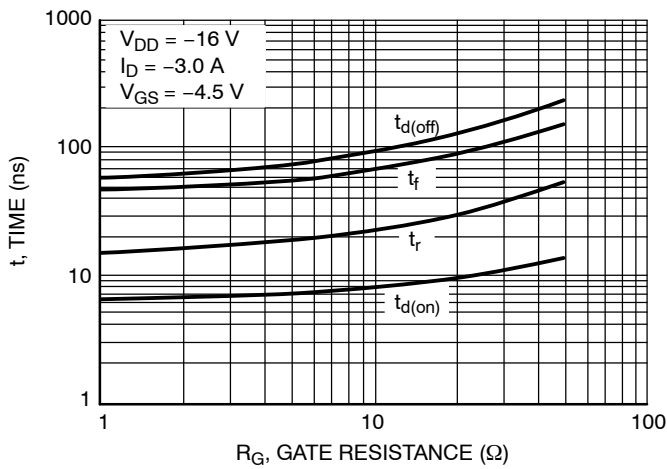

Figure 9. Resistive Switching Time Variation versus Gate Resistance

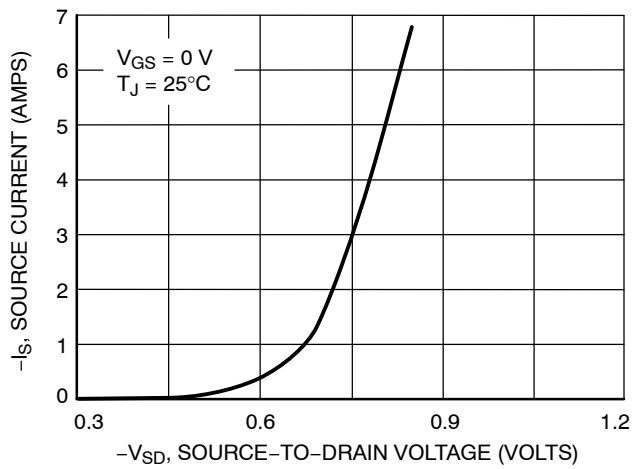

Figure 10. Diode Forward Voltage versus Current

# NTF6P02, NVF6P02

## TYPICAL ELECTRICAL CHARACTERISTICS

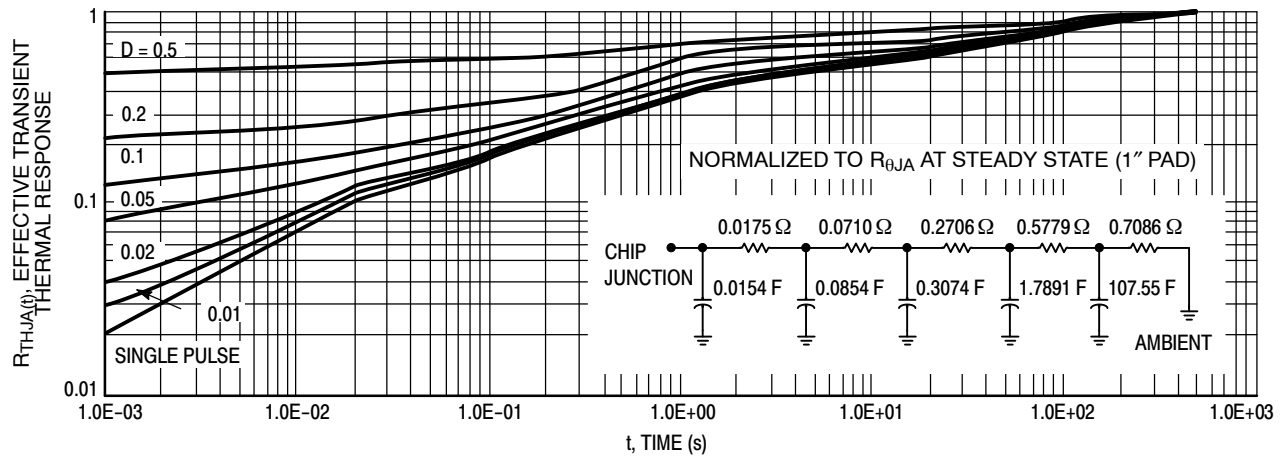
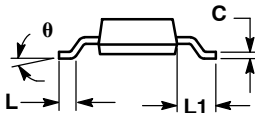
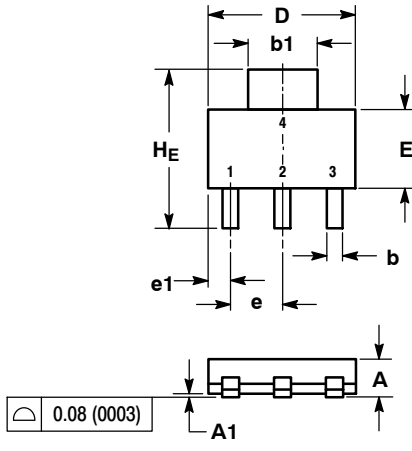

Figure 11. FET Thermal Response

# NTF6P02, NVF6P02

## PACKAGE DIMENSIONS

SOT-223 (TO-261)  
CASE 318E-04  
ISSUE N



NOTES:

1. DIMENSIONING AND TOLERANCING PER ASME Y14.5M, 1994.
2. CONTROLLING DIMENSION: INCH.

DIM	MILLIMETERS			INCHES		
	MIN	NOM	MAX	MIN	NOM	MAX
A	1.50	1.63	1.75	0.060	0.064	0.068
A1	0.02	0.06	0.10	0.001	0.002	0.004
b	0.60	0.75	0.89	0.024	0.030	0.035
b1	2.90	3.06	3.20	0.115	0.121	0.126
c	0.24	0.29	0.35	0.009	0.012	0.014
D	6.30	6.50	6.70	0.249	0.256	0.263
E	3.30	3.50	3.70	0.130	0.138	0.145
e	2.20	2.30	2.40	0.087	0.091	0.094
e1	0.85	0.94	1.05	0.033	0.037	0.041
L	0.20	---	---	0.008	---	---
L1	1.50	1.75	2.00	0.060	0.069	0.078
HE	6.70	7.00	7.30	0.264	0.276	0.287
θ	0°	---	10°	0°	---	10°

STYLE 3:

1. GATE
2. DRAIN
3. SOURCE
4. DRAIN

### SOLDERING FOOTPRINT\*

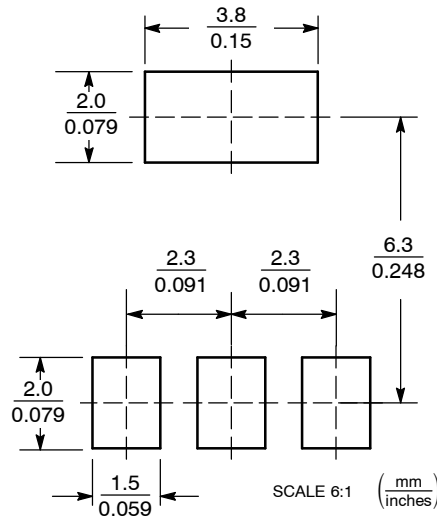

\*For additional information on our Pb-Free strategy and soldering details, please download the ON Semiconductor Soldering and Mounting Techniques Reference Manual, SOLDERRM/D.

ON Semiconductor and are registered trademarks of Semiconductor Components Industries, LLC (SCILLC). SCILLC owns the rights to a number of patents, trademarks, copyrights, trade secrets, and other intellectual property. A listing of SCILLC's product/patent coverage may be accessed at [www.onsemi.com/site/pdf/Patent-Marking.pdf](http://www.onsemi.com/site/pdf/Patent-Marking.pdf). SCILLC reserves the right to make changes without further notice to any products herein. SCILLC makes no warranty, representation or guarantee regarding the suitability of its products for any particular purpose, nor does SCILLC assume any liability arising out of the application or use of any product or circuit, and specifically disclaims any and all liability, including without limitation special, consequential or incidental damages. "Typical" parameters which may be provided in SCILLC data sheets and/or specifications can and do vary in different applications and actual performance may vary over time. All operating parameters, including "Typicals" must be validated for each customer application by customer's technical experts. SCILLC does not convey any license under its patent rights nor the rights of others. SCILLC products are not designed, intended, or authorized for use as components in systems intended for surgical implant into the body, or other applications intended to support or sustain life, or for any other application in which the failure of the SCILLC product could create a situation where personal injury or death may occur. Should Buyer purchase or use SCILLC products for any such unintended or unauthorized application, Buyer shall indemnify and hold SCILLC and its officers, employees, subsidiaries, affiliates, and distributors harmless against all claims, costs, damages, and expenses, and reasonable attorney fees arising out of, directly or indirectly, any claim of personal injury or death associated with such unintended or unauthorized use, even if such claim alleges that SCILLC was negligent regarding the design or manufacture of the part. SCILLC is an Equal Opportunity/Affirmative Action Employer. This literature is subject to all applicable copyright laws and is not for resale in any manner.

### PUBLICATION ORDERING INFORMATION

**LITERATURE FULFILLMENT:**  
Literature Distribution Center for ON Semiconductor  
P.O. Box 5163, Denver, Colorado 80217 USA  
Phone: 303-675-2175 or 800-344-3860 Toll Free USA/Canada  
Fax: 303-675-2176 or 800-344-3867 Toll Free USA/Canada  
Email: [orderlit@onsemi.com](mailto:orderlit@onsemi.com)

**N. American Technical Support:** 800-282-9855 Toll Free  
USA/Canada  
**Europe, Middle East and Africa Technical Support:**  
Phone: 421 33 790 2910  
**Japan Customer Focus Center**  
Phone: 81-3-5817-1050

**ON Semiconductor Website:** [www.onsemi.com](http://www.onsemi.com)  
**Order Literature:** <http://www.onsemi.com/orderlit>

For additional information, please contact your local Sales Representative