

6.2 mm×3.7 mm Double-action
Side-operational Edge Mount / SMD
Light Touch Switches

Type: **EVQQ0**

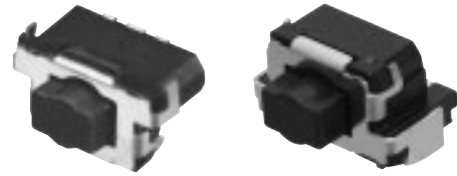

■ Features

- External dimensions : 6.2 mm×3.75 mm (Excluding the push plate), Height : 3.5 mm (EVQQ0C Type : Printed circuit board being as low as 1.35 mm)
- Good operability due to long stroke : 1st 0.4 mm, 2nd 0.5 mm
- Improved soldering strength in the operating direction when mounted on PC board edge

■ Recommended Applications

- Camera function
(Digital still cameras, Camcorders, Mobile phones, etc.)
- Operating switches for menu scrolling and confirmation for portable equipment.

■ Explanation of Part Numbers

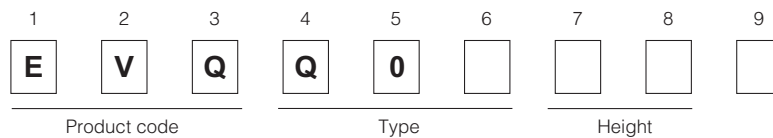



■ Specifications

Type	Snap action/Push-on type SPDT	
Electrical	Circuit Diagram	
	Rating	10 μA 2 Vdc to 20 mA 15 Vdc (Resistive load)
	Contact Resistance	500 mΩ max.
	Insulation Resistance	100 MΩ min. (at 100 Vdc)
	Dielectric Withstanding Voltage	100 Vac for 1 minute
Mechanical	Bouncing	5 ms max. (ON) 20 ms max. (OFF)
	Operating Force (1st Action)	1.0 N
	Operating Force (2nd Action)	2.6 N
	Travel (1st Action)	0.4 mm
	Travel (2nd Action)	0.5 mm
Push Strength	30 N for 1 minute	
Endurance	Operating Life	1st Action with click : 200000 cycles min.
Operating Temperature		-20 °C to +70 °C
Storage Temperature		-40 °C to +85 °C (Bulk) -20 °C to +60 °C (Taping)
Minimum Quantity/Packing Unit		2500 pcs. Embossed Taping (Reel Pack)
Quantity/Carton		12500 pcs.

Design and specifications are each subject to change without notice. Ask factory for the current technical specifications before purchase and/or use. Should a safety concern arise regarding this product, please be sure to contact us immediately.

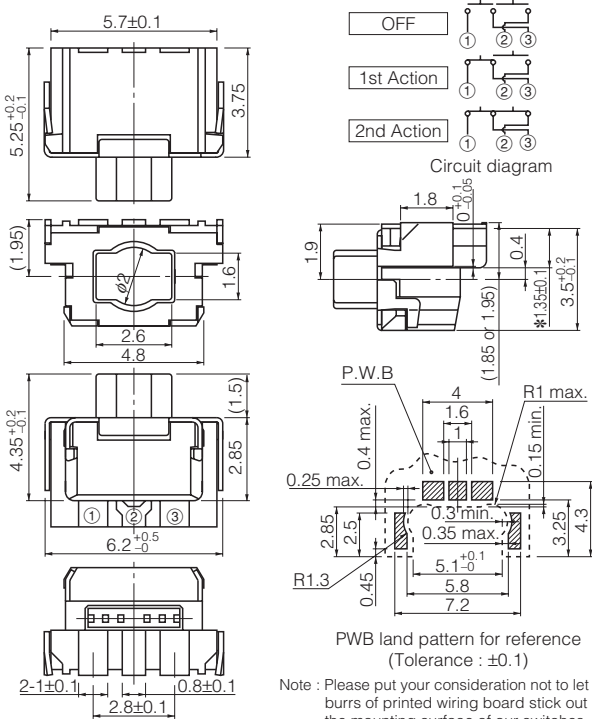
■ Dimensions in mm (not to scale)

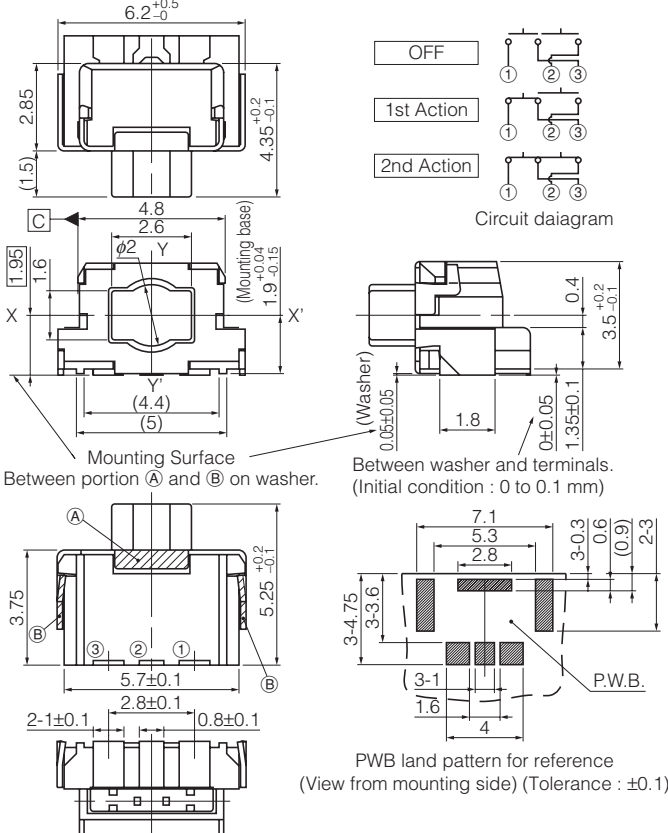
<p>No. 1</p> <p>EVQQ0C0 (Embossed Taping)</p> 	 <p>OFF</p> <p>1st Action</p> <p>2nd Action</p> <p>Circuit diagram</p> <p>* Height from surface of PCB : 1.35 mm</p>		
<p>Part Numbers</p> <p>EVQQ0C03K</p>	<p>Operating Force</p> <p>1st Action/1.0 N (With click) 2nd Action/2.6 N</p>	<p>Height</p> <p>3.5 mm</p>	<p>Operating Life</p> <p>200000 cycles</p>
<p>No. 2</p> <p>EVQQ0G0 (Embossed Taping)</p> 	 <p>OFF</p> <p>1st Action</p> <p>2nd Action</p> <p>Circuit diagram</p> <p>Mounting Surface Between portion (A) and (B) on washer.</p> <p>Between washer and terminals. (Initial condition : 0 to 0.1 mm)</p> <p>Support P.W.B.</p>		
<p>Part Numbers</p> <p>EVQQ0G03K</p>	<p>Operating Force</p> <p>1st Action/1.0 N (With click) 2nd Action/2.6 N</p>	<p>Height</p> <p>3.5 mm</p>	<p>Operating Life</p> <p>200000 cycles</p>

Design and specifications are each subject to change without notice. Ask factory for the current technical specifications before purchase and/or use. Should a safety concern arise regarding this product, please be sure to contact us immediately.

■ Recommended Reflow Soldering Conditions

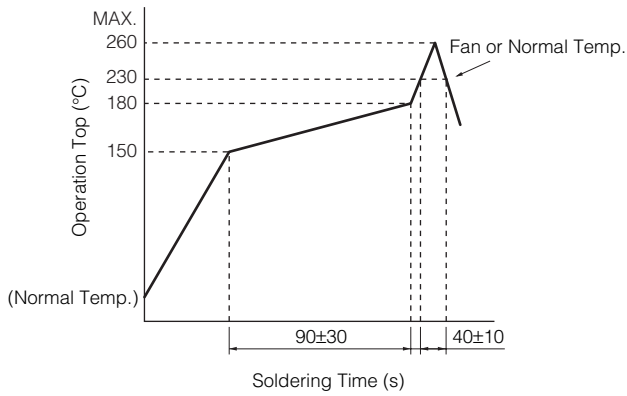

● Embossed Carrier Taping

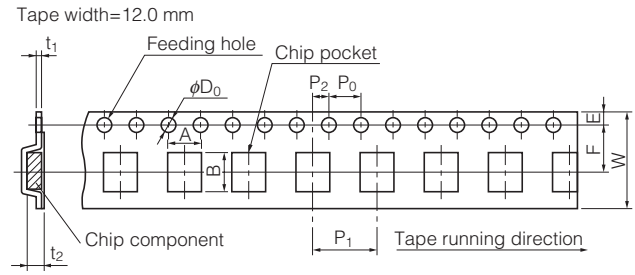

Unit: mm

Part No.	Height	A	B	W	F	E	P_1	P_2	P_0	D_0 Dia.	t_1	t_2
EVQQ0C	3.5	6.6±0.2	5.7±0.2	12.0±0.3	5.5±0.1	1.75±0.10	8.0±0.1	2.0±0.1	4.0±0.1	1.5 ^{+0.1} ₀	0.4±0.1	3.8±0.2
EVQQ0G			5.8±0.2									3.7±0.2

● Standard Reel Dimensions in mm (not to scale)

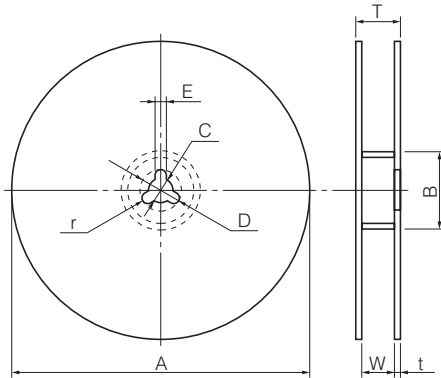

Item	A	B	C	D	E
Rate (mm)	$\phi 380.0 \pm 2.0$	$\phi 80.0 \pm 1.0$	$\phi 13.0 \pm 0.5$	$\phi 21.0 \pm 1.0$	2.0±0.5

Item	W	T	t	r
Rate (mm)	13.5±1.0	17.5±1.0	1.0 to 3.0	1.0±0.5