

Safety-door Switch D4BS

CSM_D4BS_DS_E_3_1

The Special Operation Key Activates a Direct Opening Mechanism to Open the Contacts and Shut Off Control Circuits when Protective Doors Are Opened on Machine Tools or Other Equipment

Note: Contact your sales representative for details on models with safety standard certification.



- Conforms to EN (TÜV) standards corresponding to the CE marking.
- Certified by UL and CSA standards.
- The Switch contact is opened by a direct opening mechanism (NC contacts only) when the protective cover is opened. The EN-certified direct opening mechanism is indicated by  on the Switch.
- Malfunctions and false operation prevented by special Operation Key.
- Wide temperature range specifications: -40 to 80°C.
- Degree of protection of the switch box: IP67 (EN60947-5-1).
- Series includes models with gold-plated contacts for handling the microload range.





 Be sure to read the "Safety Precautions" on page 7 and the "Precautions for All Safety Door Switches".

Model Number Structure

Model Number Legend

Switch

D4BS -    S

1 2 3

1. Conduit

- 1: PG13.5 (1 conduit)
- 2: G1/2 (1 conduit)
- 3: 1/2-14NPT (1 conduit)
- 4: M20 (1 conduit)
- 5: PG13.5 (3-conduit)
- 6: G1/2 (3-conduit)
- 7: 1/2-14NPT (3-conduit)
- 8: M20 (2-conduit)

2. Built-in Switch

- 5: 1NC/1NO (slow-action)
- 6: 1NC/NO (slow-action), gold-plated contacts
- A: 2NC (slow-action)
- B: 2NC (slow-action), gold-plated contacts

3. Head Mounting Direction

- F: Four mounting directions possible (front-side mounting at shipping)

Operation Key

D4BS - K  1

1

1. Operation Key Type

- 1: Horizontal mounting
- 2: Vertical mounting
- 3: Adjustable mounting (Horizontal)

Note: An order for the head part or the switch part alone cannot be accepted. (The Operation Key is sold separately.)











Ordering Information

List of Models



Switches (Operation Keys are sold separately.)

 : Models with certified direct opening contacts.

Consult with your OMRON representative when ordering any models that are not listed in this table.

Type	Mounting direction		Conduit size	1NC/1NO (Slow-action)	2NC (Slow-action)
1-conduit	Front-side mounting		Pg13.5	 D4BS-15FS	D4BS-1AFS
			G1/2	 D4BS-25FS	D4BS-2AFS
			1/2-14NPT	 D4BS-35FS	D4BS-3AFS
			M20	 D4BS-45FS	D4BS-4AFS
3-conduit	Front-side mounting		Pg13.5	 D4BS-55FS	D4BS-5AFS
			G1/2	 D4BS-65FS	D4BS-6AFS
			1/2-14NPT	 D4BS-75FS	D4BS-7AFS
			M20	 D4BS-85FS	D4BS-8AFS

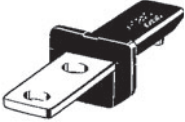
Operation Keys

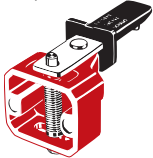
Type	Model
Horizontal mounting 	D4BS-K1
Vertical mounting 	D4BS-K2
Adjustable mounting (Horizontal) 	D4BS-K3

Specifications

Standards and EC Directives

Conforms to the following EC Directives:

- Machinery Directive
- Low Voltage Directive
- EN50041
- EN1088

Certified Standards

Certification body	Standard	File No.
TÜV Rheinland	EN60947-5-1 (certified direct opening) GS-ET-15	J50084815
UL	UL508	E76675
CSA	CSA C22.2 No. 14	LR45746
CQC (CCC)	GB14048.5	2003010305073833

Certified Standard Ratings

TÜV (EN60947-5-1), CCC (GB14048.5)

Item	Utilization category	AC-15
Rated operating current (I _e)		2 A
Rated operating voltage (U _e)		400 V

Note: Use a 10 A fuse type a gI or gG that conforms to IEC60269 as a short-circuit protection device.

UL/CSA (UL508, CSA C22.2 No. 14) (A600)

Rated voltage	Carry current	Current (A)		Volt-amperes (VA)	
		Make	Break	Make	Break
120 VAC	10 A	60	6	7,200	720
240 VAC		30	3		
480 VAC		15	1.5		
600 VAC		12	1.2		

Characteristics

Degree of protection *1		IP67 (EN60947-5-1)
Durability *2	Mechanical	1,000,000 operations min.
	Electrical	500,000 operations min. (10 A resistive load at 250 VAC)
Operating speed		0.1 m/s to 0.5 m/s
Operating frequency		30 operations/minute max.
Direct opening force *3		19.61 N min. (EN60947-5-1)
Direct opening travel *3		20 mm min. (EN60947-5-1)
Contact resistance		25 mΩ max.
Rated insulation voltage (U_i)		600 V (EN60947-5-1)
Rated frequency		50/60 Hz
Protection against electric shock		Class I (with ground terminal)
Pollution degree (operating environment)		3 (EN60947-5-1)
Impulse withstand voltage (EN60947-5-1)	Between terminals of same polarity	4 kV
	Between terminals of different polarity	
	Between each terminal and ground	
Insulation resistance		100 MΩ min. (at 500 VDC) between terminals of same or different polarity, between each terminal and ground, and between each terminal and non-current-carrying metal part
Contact gap		2 × 2 mm min.
Vibration resistance	Malfunction	10 to 500 Hz, 0.65 mm single amplitude
	Destruction	1,000 m/s ² min. (IEC68-2-27)
Shock resistance	Malfunction	300 m/s ² min. (IEC68-2-27)
	Destruction	1,000 m/s ² min. (IEC68-2-27)
Conditional short-circuit current		100 A (EN60947-5-1)
Conventional enclosed thermal current (I_{the})		20 A (EN60947-5-1)
Ambient operating temperature		-40 to 80°C (with no icing)
Ambient operating humidity		95% max.
Weight		Approx. 285 g (D4BS-15FS)

Note: The above values are initial values.

*1. The degree of protection is tested using the method specified by the standard (EN60947-5-1). Confirm that sealing properties are sufficient for the operating conditions and environment beforehand. Although the switch box is protected from dust, oil, or water penetration, do not use the D4BS in places where dust, oil, water, or chemicals may enter through the key hole on the head, otherwise Switch damage or malfunctioning may occur.

*2. The durability is for an ambient temperature of 5 to 35°C and an ambient humidity of 40% to 70%. Contact your OMRON sales representative for more detailed information on other operating environments.

*3. These figures are minimum requirements for safe operation.

Structure and Nomenclature

Structure

Operation Key
D4BS's exclusive-use Operation Key is provided to assure accurate switching operation.

Set Zone Mark
A triangular Set Zone Mark makes it easy to adjust the operating position when inserting the Operation Key.

Built-in Switch
A shearing force contact separating mechanism (NC contact) is employed, which positively pulls apart the contacts from each other by using shearing force if any abnormality such as contact welding should occur in the contact area.
There is a difference in level between the NC and NO terminal, which assures easy wiring.

Ground Terminal Screw
A ground terminal is provided to improve safety. (Built into the Unit.)

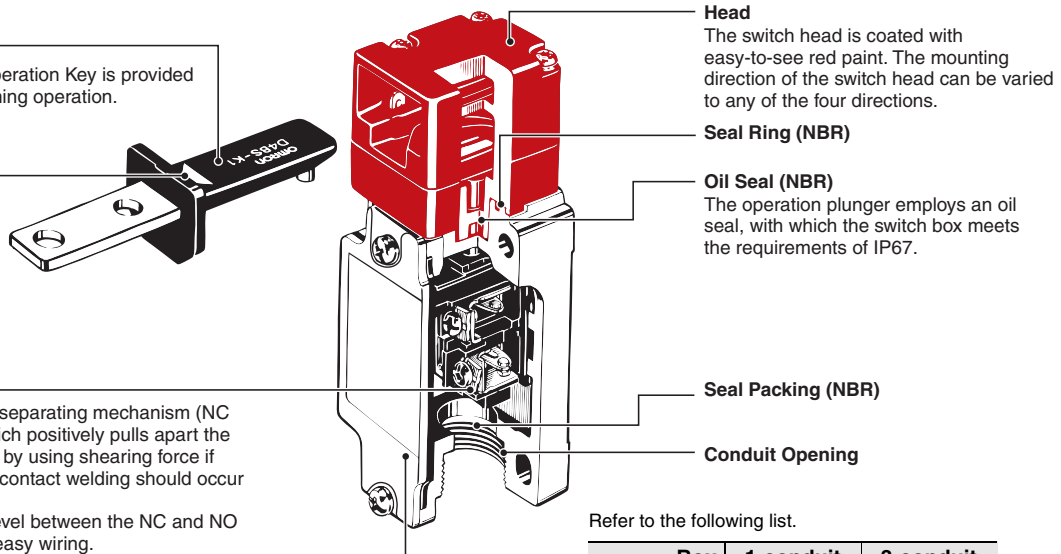

Refer to the following list.

Size	Box	1-conduit box	3-conduit box
Pg13.5		Yes	Yes
G1/2		Yes	Yes
1/2-14NPT		Yes	Yes

Contact Form (Diagrams Show State with Key Inserted)

Model	Contact form	Operating pattern	Remarks
D4BS-□5□S	1NC/1NO 		Only NC contact 11-12 has a certified direct opening mechanism. (→) Terminals 11-12 and 23-24 can be used as unlike poles.
D4BS-□A□S	2NC 		NC contacts 11-12 and 21-22 have a certified direct opening mechanism. (→) Terminals 11-12 and 21-22 can be used as unlike poles.

Note: The terminal numbers are in accordance with EN50013, and the contact symbols are in accordance with IEC60947-5-1.

Dimensions and Operating Characteristics

(Unit: mm)

Switches

1-conduit

- D4BS-1□□S
- D4BS-2□□S
- D4BS-3□□S

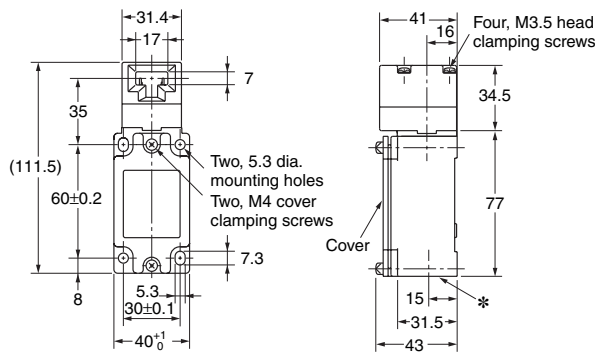
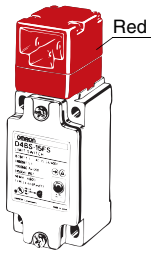

Operating characteristics	Model	D4BS-1□□S D4BS-2□□S D4BS-3□□S
Key insertion force		19.61 N max.
Key extraction force		19.61 N max.
Pretravel (PT)		10±5 mm
Total travel		23 mm min.
Direct opening force		19.61 N min.
Direct opening stroke		20 mm min.

3-conduit

- D4BS-5□□S
- D4BS-6□□S
- D4BS-7□□S

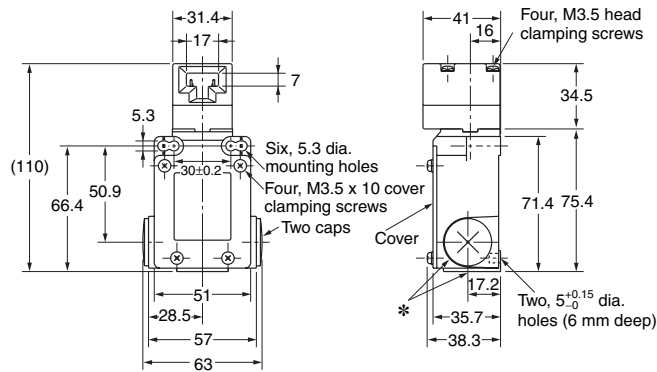
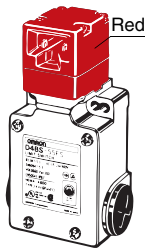

Operating characteristics	Model	D4BS-5□□S D4BS-6□□S D4BS-7□□S
Key insertion force		19.61 N max.
Key extraction force		19.61 N max.
Pretravel (PT)		10±5 mm
Total travel		23 mm min.
Direct opening force		19.61 N min.
Direct opening stroke		20 mm min.

Note: 1. Unless otherwise specified, a tolerance of ±0.4 mm applies to all dimensions.

2. There are fluctuations in the contact ON/OFF timing for 2NC contacts. Confirm performance before application.

* The conduit thread varies with the model as follows:

D4BS-1□□S, D4BS-5□□S: Pg 13.5

D4BS-2□□S, D4BS-6□□S: G1/2

D4BS-3□□S, D4BS-7□□S: 1/2-14NPT

Operation Keys

D4BS-K1

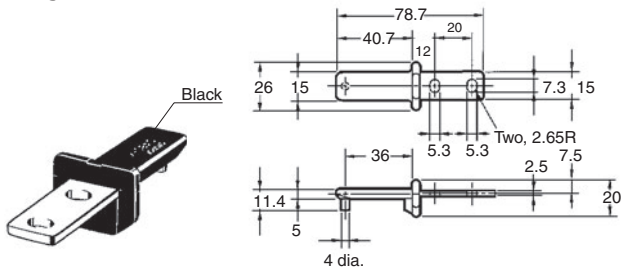

D4BS-K3

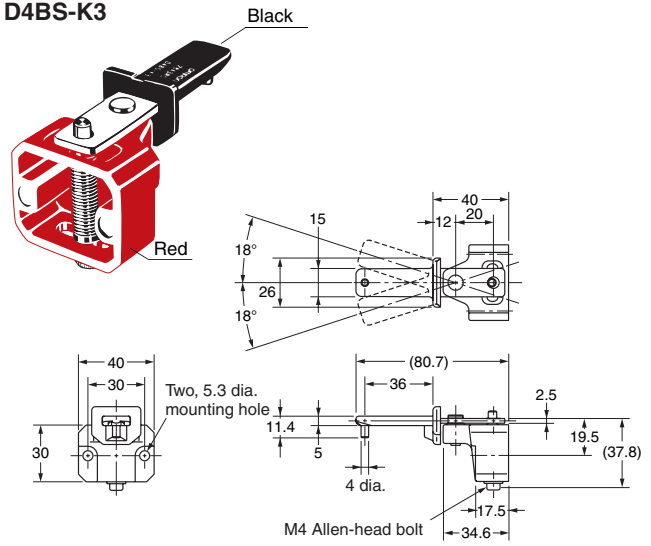

D4BS-K2

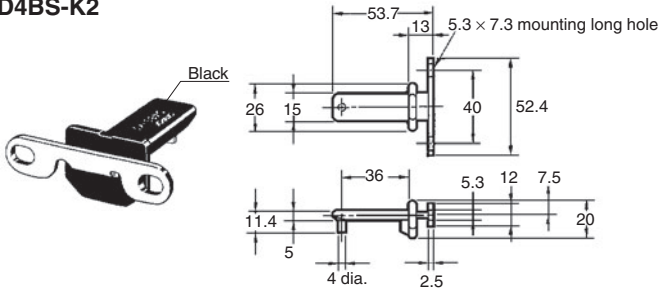

With Operation Key Inserted

- D4BS-1□□S + D4BS-K1
- D4BS-2□□S + D4BS-K1
- D4BS-3□□S + D4BS-K1

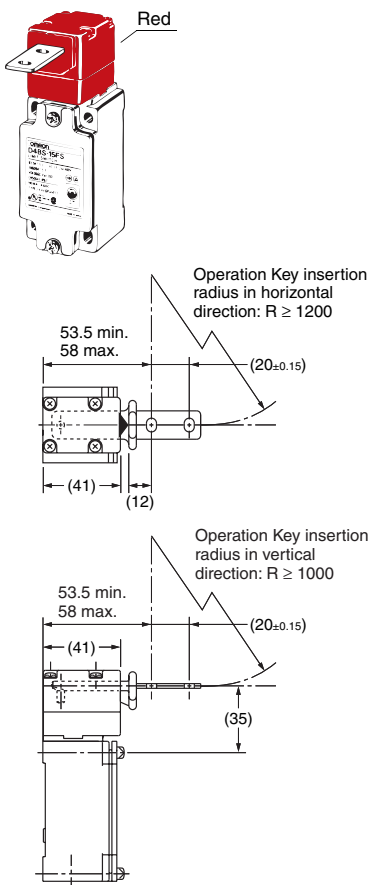

- D4BS-1□□S + D4BS-K2
- D4BS-2□□S + D4BS-K2
- D4BS-3□□S + D4BS-K2

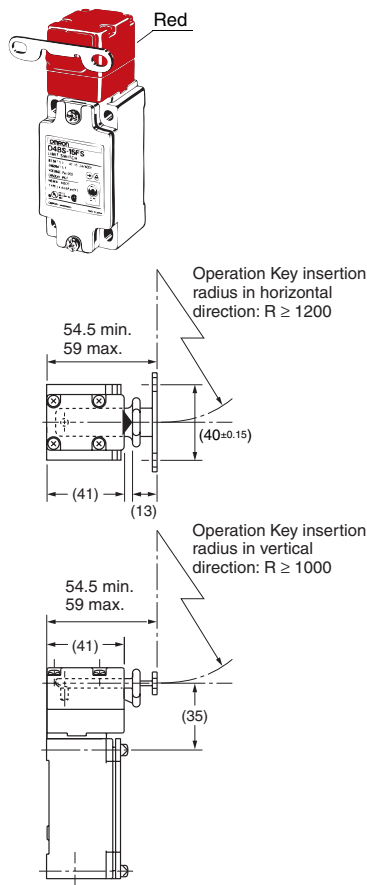

- D4BS-1□□S + D4BS-K3
- D4BS-2□□S + D4BS-K3
- D4BS-3□□S + D4BS-K3

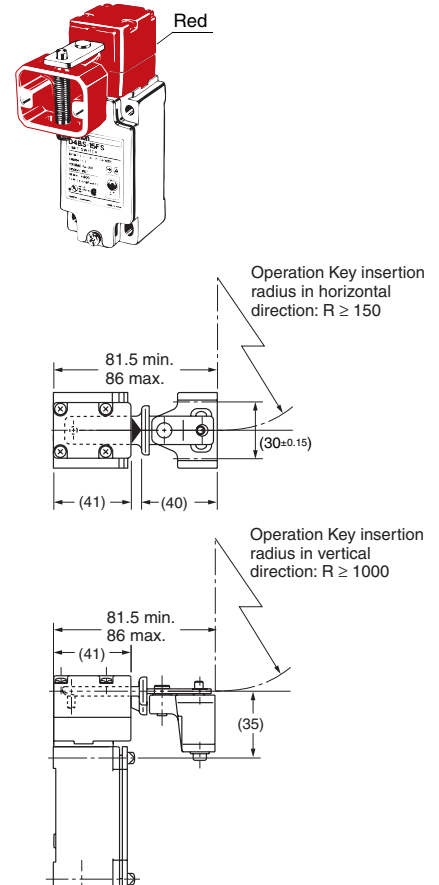

Note: Unless otherwise specified, a tolerance of ±0.4 mm applies to all dimensions.

Safety Precautions

Refer to the “Precautions for All Switches” and “Precautions for All Safety Door Switches”.

Precautions for Safe Use

- Do not use the Switch submersed in oil or water or in locations continuously subject to splashes of oil or water. Doing so may result in oil or water entering the Switch. (The IP67 degree of protection of the Switch specifies the amount of water penetration after the Switch is submersed in water for a certain period of time.)
- Always attach the cover after completing wiring and before using the Switch. Also, do not turn ON the Switch with the cover open. Doing so may result in electric shock.

Stopper Installation

Do not use a Switch as a stopper.

Be sure to install a stopper as shown in the following illustration when mounting the Switch and adjust the stopper so that the Operation Key is within the setting zone.

Do not subject the Switch to a shock that exceeds the Switch's shock resistance of 1,000 m/s².

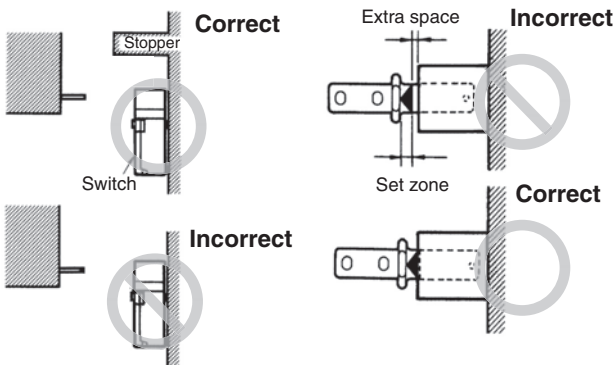

Precautions for Correct Use

Appropriate Tightening Torque

Loose screws may result in malfunction. Tighten the screws to the specified torques.

Type	Appropriate tightening torque
M3.5 terminal screw (including ground terminal screw)	0.59 to 0.78 N·m
Cover mounting screw *1	1.18 to 1.37 N·m
Head mounting screw	0.78 to 0.98 N·m
M5 body mounting screw *2	4.90 to 5.88 N·m
Operation Key mounting screw	2.35 to 2.75 N·m
Connector	1.77 to 2.16 N·m
Cap screw	1.27 to 1.67 N·m

*1. Apply a torque of 0.78 to 0.88 N·m if the D4BS is a three-conduit model.

*2. Apply a torque of 4.90 to 5.88 N·m for an Allen-head bolt. For a pan head screw, apply a torque of 2.35 to 2.75 N·m.

Mounting Dimensions (M5)

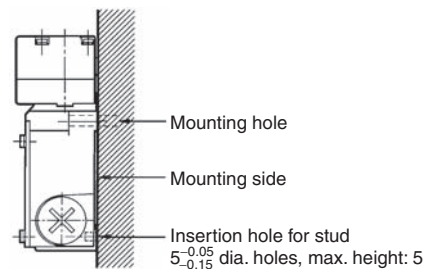
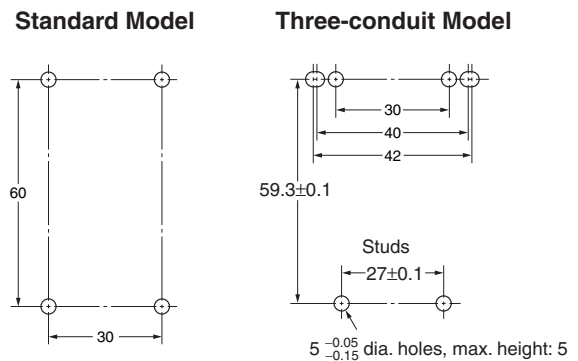

With a Three-conduit Model, the Switch can be mounted more securely at four points rather than with just two mounting holes, i.e., by adding two studs at the bottom of the switch, each of which is 5 mm maximum in height and 5^{-0.05/-0.15} mm in diameter as shown below.

Mounting Hole Dimensions for Operation Keys

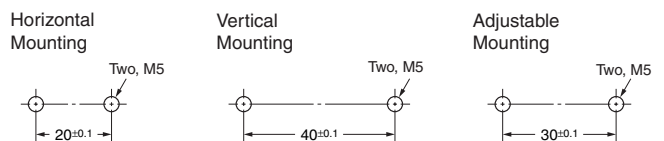

Use spring washers to mount the Switch and Operation key, and tighten the screws to a suitable torque.

To ensure safety, use screws that cannot be easily removed or another means to prevent the Switch and Operation Key from easily being removed.

Operation Key

Make sure that the Operation Key can be inserted properly with a tolerance of ± 0.5 mm in the upward, downward, left, or right direction. Otherwise the D4BS may soon become damaged due to misalignment.

Observe the specified insertion radius for the Operation Key and insert it in a direction perpendicular to the key hole. Do not use the D4BL operation key.

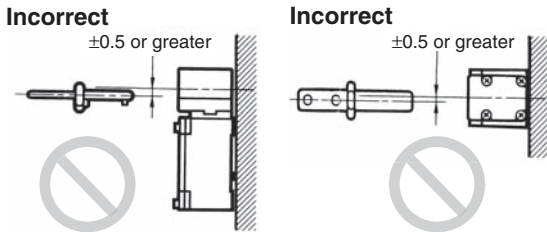

Changes in Head Mounting Direction

By removing the screws on the four corners of the head, the head can be reset in any of four directions. The head direction can be changed with or without the Operation Key inserted in the head. Make sure that no foreign materials enter through the head and that the head is tightened securely within the proper torque range.

Wiring

Do not connect the lead wires directly to the terminals. Connect the lead wires through insulation tubes and M3.5 round crimp terminals. Tighten each terminal screw within the proper torque range.

The proper lead wire is AWG20 to AWG14 (0.5 to 2.5 mm²) in size.

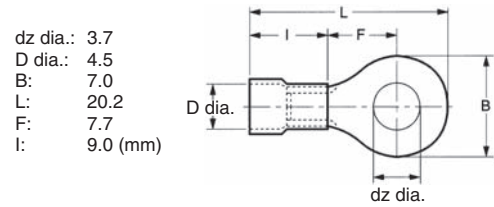

Wire using the methods shown below so that the crimp terminals are not caught on the case or cover. Otherwise it may not be possible to mount the cover completely and malfunctions may occur.

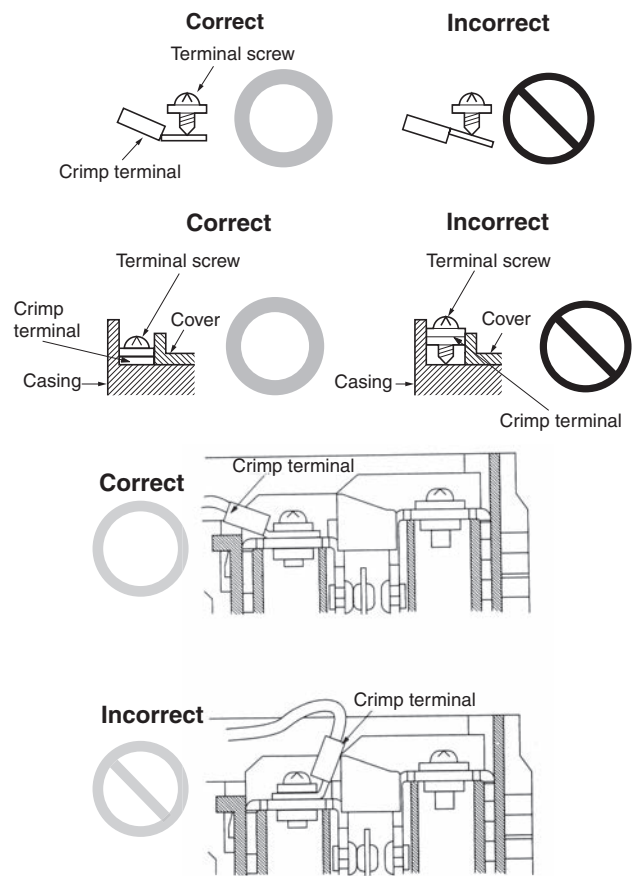

Conduit Opening

- Tighten the connector to a suitable torque.
- Excessive tightening torque may damage the casing.
- When using 1/2-14NPT conduits, apply sealing tape between the connector and conduit opening to maintain the degree of protection (IP67) of the Switch.
- If using a Pg13.5 conduit, use an ABS-08 Pg13.5 connector or an ABS-12 Pg13.5 connector (manufactured by Nippon Flex).
- Use a connector (SC Series, sold separately) suitable for the outer diameter of the cable.
- When wiring a 3-conduit model, securely tighten the cap screw provided for unused conduit openings.

Read and Understand This Catalog

Please read and understand this catalog before purchasing the products. Please consult your OMRON representative if you have any questions or comments.

Warranty and Limitations of Liability

WARRANTY

OMRON's exclusive warranty is that the products are free from defects in materials and workmanship for a period of one year (or other period if specified) from date of sale by OMRON.

OMRON MAKES NO WARRANTY OR REPRESENTATION, EXPRESS OR IMPLIED, REGARDING NON-INFRINGEMENT, MERCHANTABILITY, OR FITNESS FOR PARTICULAR PURPOSE OF THE PRODUCTS. ANY BUYER OR USER ACKNOWLEDGES THAT THE BUYER OR USER ALONE HAS DETERMINED THAT THE PRODUCTS WILL SUITABLY MEET THE REQUIREMENTS OF THEIR INTENDED USE. OMRON DISCLAIMS ALL OTHER WARRANTIES, EXPRESS OR IMPLIED.

LIMITATIONS OF LIABILITY

OMRON SHALL NOT BE RESPONSIBLE FOR SPECIAL, INDIRECT, OR CONSEQUENTIAL DAMAGES, LOSS OF PROFITS OR COMMERCIAL LOSS IN ANY WAY CONNECTED WITH THE PRODUCTS, WHETHER SUCH CLAIM IS BASED ON CONTRACT, WARRANTY, NEGLIGENCE, OR STRICT LIABILITY.

In no event shall the responsibility of OMRON for any act exceed the individual price of the product on which liability is asserted.

IN NO EVENT SHALL OMRON BE RESPONSIBLE FOR WARRANTY, REPAIR, OR OTHER CLAIMS REGARDING THE PRODUCTS UNLESS OMRON'S ANALYSIS CONFIRMS THAT THE PRODUCTS WERE PROPERLY HANDLED, STORED, INSTALLED, AND MAINTAINED AND NOT SUBJECT TO CONTAMINATION, ABUSE, MISUSE, OR INAPPROPRIATE MODIFICATION OR REPAIR.

Application Considerations

SUITABILITY FOR USE

OMRON shall not be responsible for conformity with any standards, codes, or regulations that apply to the combination of products in the customer's application or use of the products.

At the customer's request, OMRON will provide applicable third party certification documents identifying ratings and limitations of use that apply to the products. This information by itself is not sufficient for a complete determination of the suitability of the products in combination with the end product, machine, system, or other application or use.

The following are some examples of applications for which particular attention must be given. This is not intended to be an exhaustive list of all possible uses of the products, nor is it intended to imply that the uses listed may be suitable for the products:

- Outdoor use, uses involving potential chemical contamination or electrical interference, or conditions or uses not described in this catalog.
- Nuclear energy control systems, combustion systems, railroad systems, aviation systems, medical equipment, amusement machines, vehicles, safety equipment, and installations subject to separate industry or government regulations.
- Systems, machines, and equipment that could present a risk to life or property.

Please know and observe all prohibitions of use applicable to the products.

NEVER USE THE PRODUCTS FOR AN APPLICATION INVOLVING SERIOUS RISK TO LIFE OR PROPERTY WITHOUT ENSURING THAT THE SYSTEM AS A WHOLE HAS BEEN DESIGNED TO ADDRESS THE RISKS, AND THAT THE OMRON PRODUCTS ARE PROPERLY RATED AND INSTALLED FOR THE INTENDED USE WITHIN THE OVERALL EQUIPMENT OR SYSTEM.

PROGRAMMABLE PRODUCTS

OMRON shall not be responsible for the user's programming of a programmable product, or any consequence thereof.

Disclaimers

CHANGE IN SPECIFICATIONS

Product specifications and accessories may be changed at any time based on improvements and other reasons.

It is our practice to change model numbers when published ratings or features are changed, or when significant construction changes are made. However, some specifications of the products may be changed without any notice. When in doubt, special model numbers may be assigned to fix or establish key specifications for your application on your request. Please consult with your OMRON representative at any time to confirm actual specifications of purchased products.

DIMENSIONS AND WEIGHTS

Dimensions and weights are nominal and are not to be used for manufacturing purposes, even when tolerances are shown.

PERFORMANCE DATA

Performance data given in this catalog is provided as a guide for the user in determining suitability and does not constitute a warranty. It may represent the result of OMRON's test conditions, and the users must correlate it to actual application requirements. Actual performance is subject to the OMRON Warranty and Limitations of Liability.

ERRORS AND OMISSIONS

The information in this document has been carefully checked and is believed to be accurate; however, no responsibility is assumed for clerical, typographical, or proofreading errors, or omissions.

2009.3

In the interest of product improvement, specifications are subject to change without notice.

OMRON Corporation
Industrial Automation Company

<http://www.ia.omron.com/>

(c)Copyright OMRON Corporation 2009 All Right Reserved.