

AsahiKASEI
ASAHI KASEI EMD

AKD5367A-A
AK5367A Evaluation Board Rev.0

GENERAL DESCRIPTION

AKD5367A-A is an evaluation board for the digital audio 24bit 96kHz A/D converter, AK5367A. The AKD5367A-A includes the input circuit and also has a digital interface transmitter. Further, the AKD5367A-A can achieve the interface with digital audio systems via optical connector. And it can achieve the direct interface with AKEMD's D/A converter evaluation boards of via 10-line flat cable.

■ Ordering Guide

AKD5367A-A --- AK5367A Evaluation Board
(Cable for connecting with printer port of IBM-AT compatible PC and control software are enclosed with board. This control software does not support Windows NT.)

FUNCTION

- DIT with optical output
- BNC connector for an external clock input
- 10pin header for serial control interface

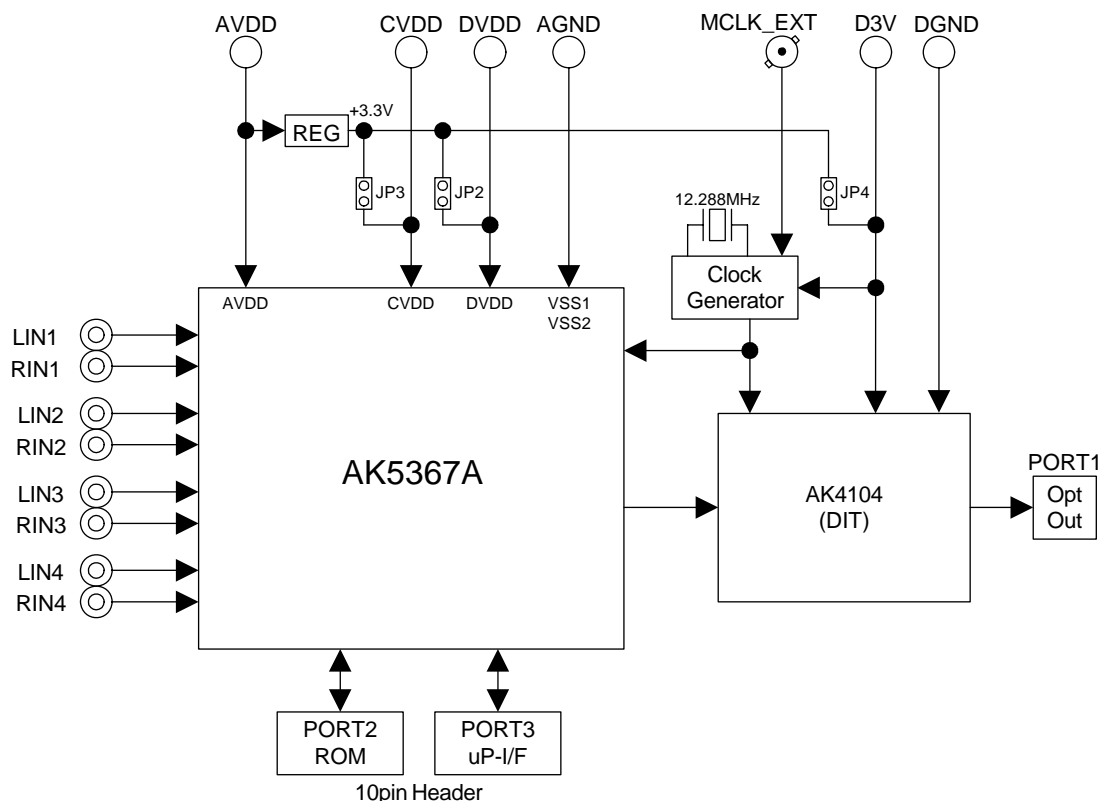

Figure 1. AKD5367A-A Block Diagram

* Circuit diagram and PCB layout are attached at the end of this manual.

■ Operation Sequence

1) Set up the power supplies lines. (Note 1)

Connector name	Connector color	Voltage	Used for	Comment and attention	Default Setting
AVDD	Orange	+4.75~+5.25 V	AVDD for AK5367A, Regulator T1.	This connector must be connected.	+5V
DVDD	Red	+3.0~+3.6V	DVDD for AK5367A	This connector is used when DVDD of AK5367A is supplied from DVDD connector without regulator T1. In this case, JP2 should be open. (Default)	+3.3V
CVDD	Red	+3.0~+3.6V	CVDD for AK5367A	This connector is used when CVDD of AK5367A is supplied from CVDD connector without regulator T1. In this case, JP3 should be open. (Default)	+3.3V
D3V	Red	+3.0~+3.6V	AK4104, Logic circuit	This connector is used when power of AK4104 and logic circuit is supplied from +3.3V connector without regulator T1. In this case, JP4 should be open. (Default)	+3.3V
AGND	Black	0V	Analog ground	This connector must be connected.	0V
DGND	Black	0V	Digital ground	This connector is used when DGND is supplied separately from AGND. In this case, JP1 should be open. (Default)	0V

Table 1. Power Supply Lines

Note 1. Each supply line should be distributed from the power supply unit.

2) Set up the evaluation mode, jumper pins and DIP switches. (See the followings.)

3) Power on.

The AK5367A and AK4104 should be reset once bringing SW1 and SW2 = "L" and return it to "H" to upon power-up.

■ Evaluation Mode

(1) Slave mode

When evaluating the AK5367A using the AK4104, the setting of the AK5367A's audio interface format should be the same as the AK4104's format. When the AK4104 is used, the audio interface format is the default setting of 16/24bit I2S compatible. Therefore, set DIF bit="1" to agree with the AK4104's format.

(1-1) A/D evaluation using AK4104 DIT function

PORT1 (DIT) is used. DIT generates audio bi-phase signal from received data and it is output through optical connector (TOTX141). It is possible to connect AKEMD's D/A converter evaluation boards on the digital-amplifier. The clock can be generated from crystal oscillator X1 or be input from J11 (BNC) or PORT2 (ROM).

(1-1-1) The MCLK is generated from crystal oscillator X1

Please set JP10 (CLK) “XTL”, open JP8 (XTE), and short JP5 (LRCK), JP6 (BICK), JP7 (MCLK), JP9 (EXT). MCLK can be selected to 256fs or 512fs with JP11 and JP12. In this case, please do not connect anything with PORT2 (ROM).

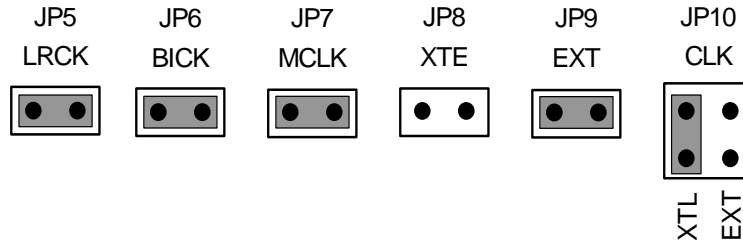

Figure 2. Switch Setting when the MCLK is Generated from Crystal Oscillator X1

(1-1-2) The MCLK is input from BNC

Please set JP10 (CLK) “EXT”, short JP5 (LRCK), JP6 (BICK), JP7 (MCLK) and JP8 (XTE), open JP9 (EXT). MCLK can be selected to 256fs or 512fs with JP11 and JP12. In this case, please do not connect anything with PORT2 (ROM).

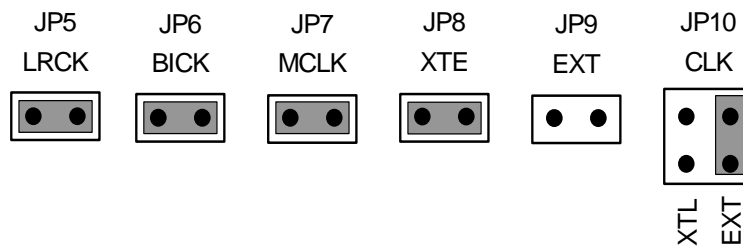

Figure 3. Switch Setting when the MCLK is Input from BNC

(1-1-3) The MCLK, BICK and LRCK input from PORT2

Please open JP5 (LRCK), JP6 (BICK), JP7 (MCLK), JP8(XTE), JP9(EXT) and JP10(CLK) when input the external clock from PORT2 (ROM).

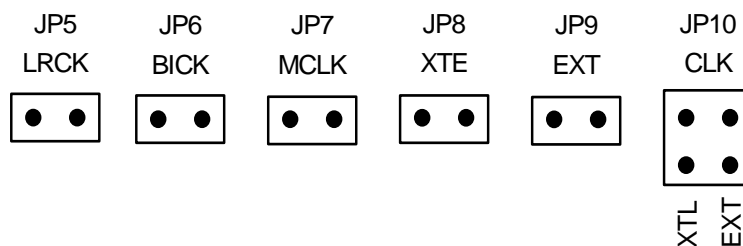

Figure 4. Switch Setting when the External Clock is Input from PORT2 (ROM)

(1-2) The A/D converter is evaluated with external AP equipment by using PORT2 (ROM)

The analog to digital conversion data can be transmitted from PORT2 (ROM). The clock can be generated from crystal oscillator X1 or J11 (BNC) or PORT2 (ROM). Refer to (1-1-1), (1-1-2) and (1-1-3) to setting the switches.

(2) Master mode

(2-1) A/D evaluation using AK4104 DIT function

PORT1 (DIT) is used. DIT generates audio bi-phase signal from received data and it is output through optical connector (TOTX141). It is possible to connect AKEMD's D/A converter evaluation boards on the digital-amplifier. The MCLK can be generated from crystal oscillator X1 or be input from J11 (BNC) or PORT2 (ROM).

(2-1-1) The MCLK is generated from crystal oscillator X1

Please set JP10 (CLK) "XTL", open JP5 (LRCK), JP6 (BICK) and JP8 (XTE), short JP7 (MCLK) and JP9 (EXT). In this case, please do not connect anything with PORT2 (ROM).

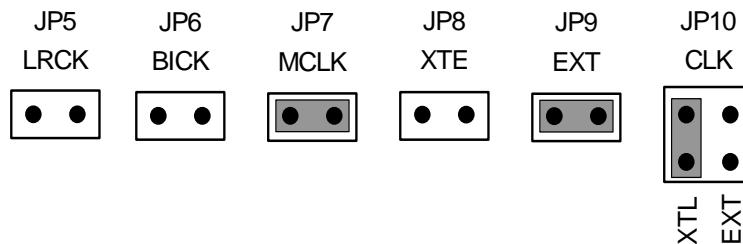

Figure 5. Switch Setting when the MCLK is Generated from Crystal Oscillator X1

(2-1-2) The MCLK input from BNC

Please set JP10 (CLK) "EXT", short JP7 (MCLK) and JP8 (XTE), open JP5 (LRCK), JP6 (BICK) and JP9 (EXT). In this case, please do not connect anything with PORT2 (ROM).

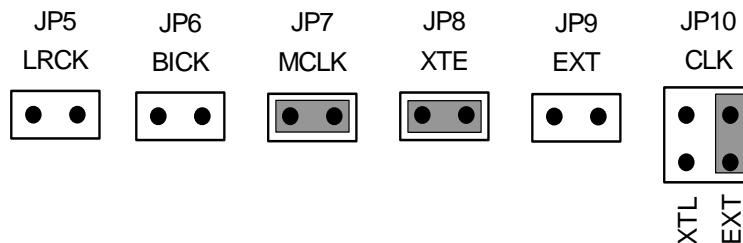

Figure 6. Switch Setting when the MCLK is Input from BNC

(2-1-3) The MCLK is input from PORT2

Please open JP5 (LRCK), JP6 (BICK), JP7 (MCLK), JP8(XTE), JP9(EXT) and JP10(CLK) when input the external clock from PORT2 (ROM).

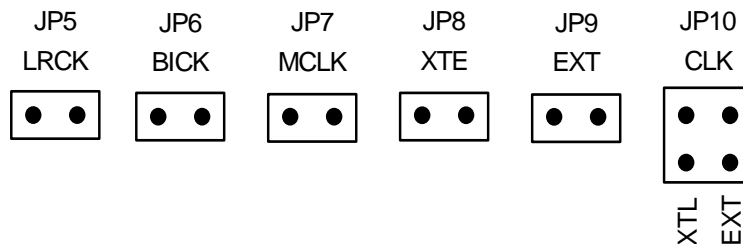

Figure 7. Switch Setting when the MCLK is Input from PORT2 (ROM)

(2-2) The A/D converter is evaluated with external AP equipment by using PORT2 (ROM)

The analog to digital conversion data can be transmitted from PORT2 (ROM). The MCLK can be generated from crystal oscillator X1 or J11 (BNC) or PORT2 (ROM). Refer to (2-1-1), (2-1-2) and (2-1-3) to setting the switches.

■ Other Jumper Pins Set Up

1. JP1 (GND): Analog and Digital ground
 OPEN: Separated. <Default>
 SHORT: Common. (The connector “DGND” can be open.)
2. JP2 (DVDD): Select AVDD for AK5367A
 OPEN: Supply from DVDD connector. <Default>
 SHORT: Supply from regulator T1. In this case, DVDD connector should be open.
3. JP3 (CVDD): Select DVDD for AK5367A
 OPEN: Supply from CVDD connector. <Default>
 SHORT: Supply from regulator T1. In this case, CVDD connector should be open.
4. JP4 (D3V): Select D3V for AK4104 and logic circuit
 OPEN: Supply from D3V connector. <Default>
 SHORT: Supply from regulator T1. In this case, D3V connector should be open.
5. JP11 (SBICK), JP12 (SLRCK): Select MCLK frequency
 256: MCLK=256fs (=12.288MHz@fs=48kHz) <Default>
 512: MCLK=512fs (=24.576MHz@fs=48kHz)

■ The Function of the Toggle SW

Upper-side is “H” and lower-side is “L”.

[SW1] (5367_PDN): Resets of AK5367A. Keep “H” during normal operation.

[SW2] (DIT_PDN): Resets of AK4104. Keep “H” during normal operation.

■ Serial Control

AKD5367A-A can be controlled through the printer port of IBM-AT compatible machine (parallel port). Please connect PORT3 (uP-I/F) and PC with bundled ten line flat cable.

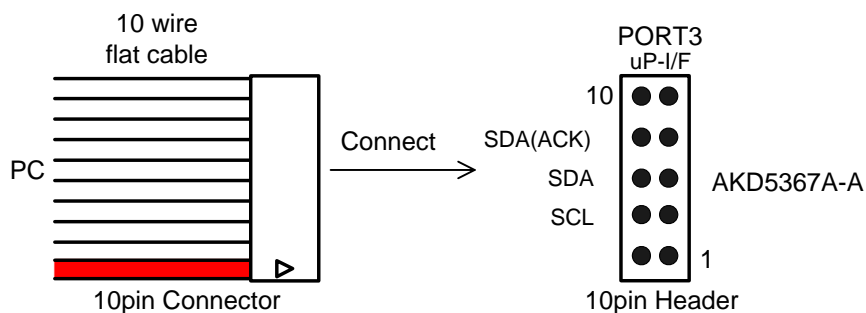

Figure 8. 10pin Header Connecting

■ Analog Input/Output Circuit

1. Analog input circuit

The analog input of AK5367A are input from J1~J8.

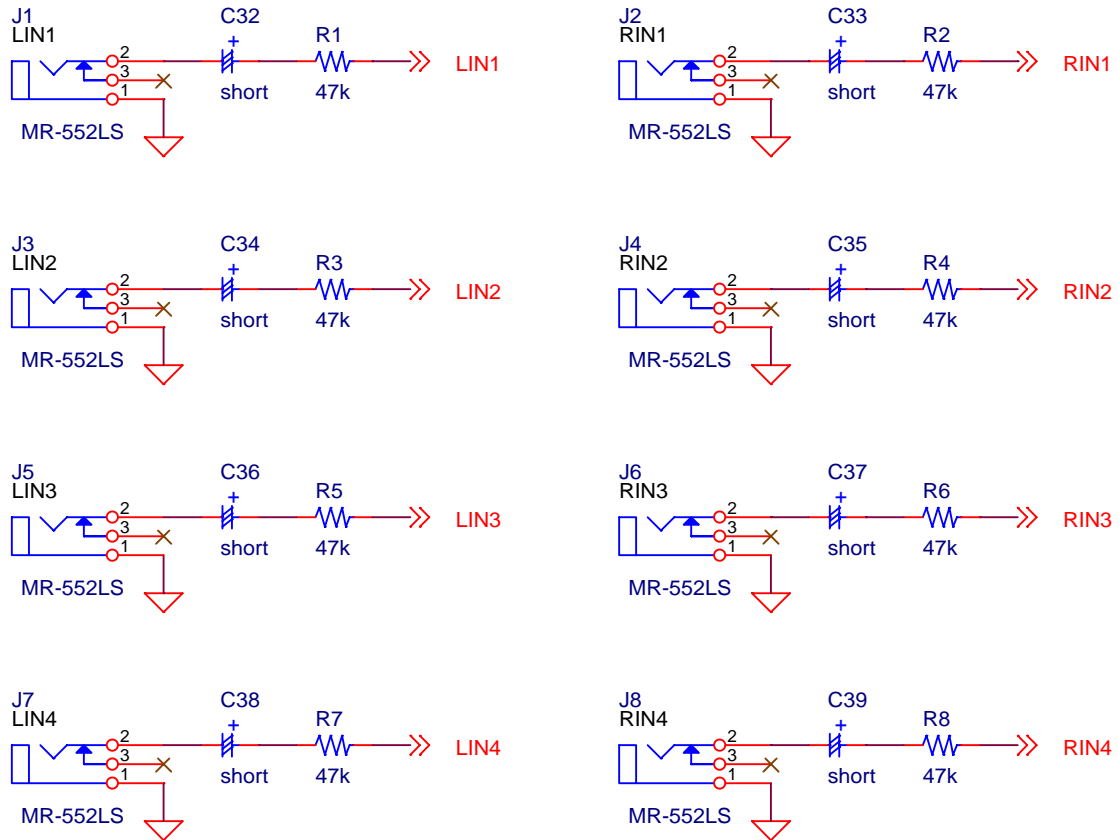

Figure 9. Analog Input Circuits

* AKEMD assumes no responsibility for the trouble when using the circuit examples.

CONTROL SOFTWARE MANUAL

■ Set-up of Evaluation Board and Control Software

1. Set up the AKD5367A-A according to previous term.
2. Connect IBM-AT compatible PC with AKD5367A-A by 10-line type flat cable (packed with AKD5367A-A). Take care of the direction of 10pin header. (Please install the driver in the CD-ROM when this control software is used on Windows 2000/XP. Please refer "Installation Manual of Control Software Driver by AKM device control software". In case of Windows95/98/ME, this installation is not needed. This control software does not operate on Windows NT.)
3. Insert the CD-ROM labeled "AKD5367A-A Evaluation Kit" into the CD-ROM drive.
4. Access the CD-ROM drive and double-click the icon of "AKD5367A-A.exe" to set up the control program.
5. Then please evaluate according to the follows.

■ Operation Flow

Keep the following flow.

1. Set up the control program according to explanation above.
2. Click "Port Reset" button.

■ Explanation of Each Buttons

1. [Port Reset]: Set up the USB interface board (AKDUSBIF-A) .
2. [Write default]: Initialize the register of AK5367A.
3. [All Write]: Write all registers that is currently displayed.
4. [Function1]: Dialog to write data by keyboard operation.
5. [Function2]: Dialog to write data by keyboard operation.
6. [Function3]: The sequence of register setting can be set and executed.
7. [Function4]: The sequence that is created on [Function3] can be assigned to buttons and executed.
8. [Function5]: The register setting that is created by [SAVE] function on main window can be assigned to buttons and executed.
9. [SAVE]: Save the current register setting.
10. [OPEN]: Write the saved values to all register.
11. [Write] : Dialog to write data by mouse operation.

■ Indication of Data

Input data is indicated on the register map. Red letter indicates "H" or "1" and blue one indicates "L" or "0". Blank is the part that is not defined in the datasheet.

■ Explanation of Each Dialog

1. [Write Dialog]: Dialog to write data by mouse operation

There are dialogs corresponding to each register.

Click the [Write] button corresponding to each register to set up the dialog. If you check the check box, data becomes "H" or "1". If not, "L" or "0".

If you want to write the input data to AK5367A, click [OK] button. If not, click [Cancel] button.

2. [Function1 Dialog]: Dialog to write data by keyboard operation

Address Box: Input registers address in 2 figures of hexadecimal.

Data Box: Input registers data in 2 figures of hexadecimal.

If you want to write the input data to AK5367A, click [OK] button. If not, click [Cancel] button.

3. [Function2 Dialog]: Dialog to evaluate ATT

Address Box: Input registers address in 2 figures of hexadecimal.

Start Data Box: Input starts data in 2 figures of hexadecimal.

End Data Box: Input end data in 2 figures of hexadecimal.

Interval Box: Data is written to AK5367A by this interval.

Step Box: Data changes by this step.

Mode Select Box:

If you check this check box, data reaches end data, and returns to start data.

[Example] Start Data = 00, End Data = 09

Data flow: 00 01 02 03 04 05 06 07 08 09 09 08 07 06 05 04 03 02 01 00

If you do not check this check box, data reaches end data, but does not return to start data.

[Example] Start Data = 00, End Data = 09

Data flow: 00 01 02 03 04 05 06 07 08 09

If you want to write the input data to AK5367A, click [OK] button. If not, click [Cancel] button.

4. [Save] and [Open]

4-1. [Save]

Save the current register setting data. The extension of file name is “akr”.

(Operation flow)

- (1) Click [Save] Button.
- (2) Set the file name and push [Save] Button. The extension of file name is “akr”.

4-2. [Open]

The register setting data saved by [Save] is written to AK5367A. The file type is the same as [Save].

(Operation flow)

- (1) Click [Open] Button.
- (2) Select the file (*.akr) and Click [Open] Button.

5. [Function3 Dialog]

The sequence of register setting can be set and executed.

- (1) Click [F3] Button.
- (2) Set the control sequence.
Set the address, Data and Interval time. Set “-1” to the address of the step where the sequence should be paused.
- (3) Click [Start] button. Then this sequence is executed.
The sequence is paused at the step of Interval= “-1”. Click [START] button, the sequence restarts from the paused step. This sequence can be saved and opened by [Save] and [Open] button on the Function3 window. The extension of file name is “aks”.

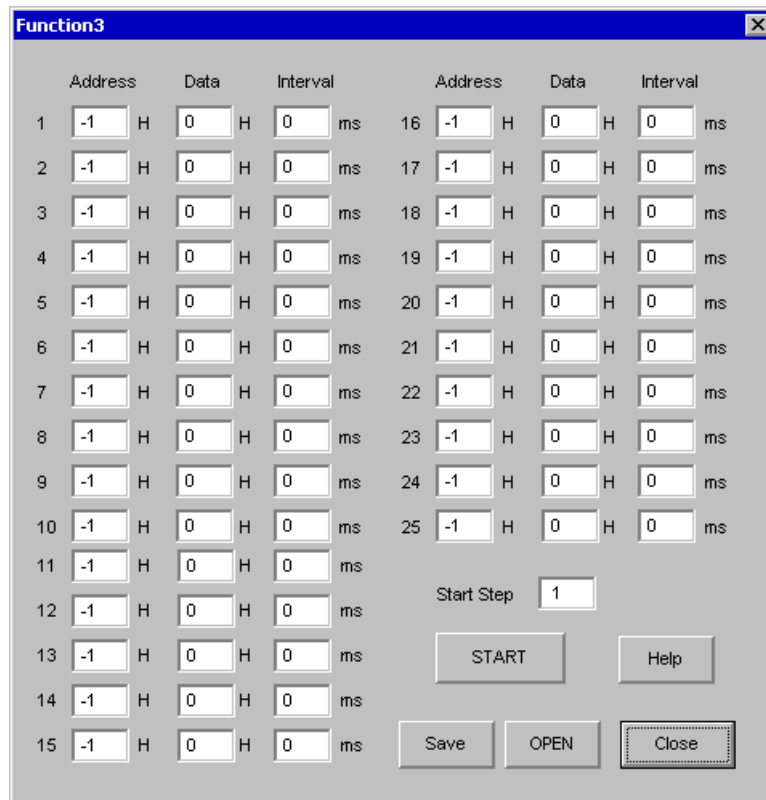

Figure 10. Window of [F3]

6. [Function4 Dialog]

The sequence that is created on [Function3] can be assigned to buttons and executed. When [F4] button is clicked, the window as shown in Figure 11 opens.

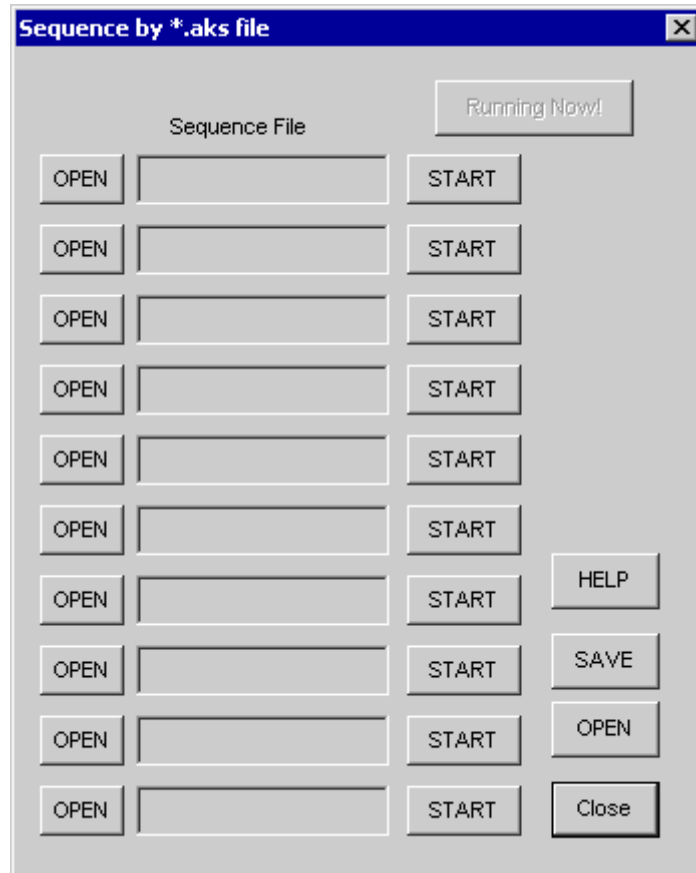

Figure 11. [F4] window

6-1. [OPEN] buttons on left side and [START] buttons

- (1) Click [OPEN] button and select the sequence file (*.aks).
The sequence file name is displayed as shown in Figure 12.

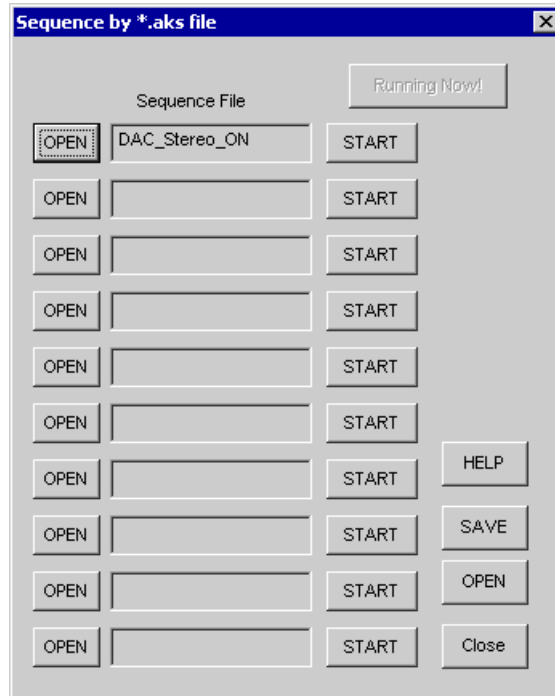

Figure 12. [F4] window (2)

- (2) Click [START] button, then the sequence is executed.

6-2. [SAVE] and [OPEN] buttons on right side

- [SAVE]: The sequence file names can assign be saved. The file name is *.ak4.
- [OPEN]: The sequence file names assign that are saved in *.ak4 are loaded.

6-3. Note

- (1) This function doesn't support the pause function of sequence function.
- (2) All files need to be in same folder used by [SAVE] and [OPEN] function on right side.
- (3) When the sequence is changed in [Function3], the file should be loaded again in order to reflect the change.

7. [Function5 Dialog]

The register setting that is created by [SAVE] function on main window can be assigned to buttons and executed. When [F5] button is clicked, the following window as shown in Figure 13 opens.

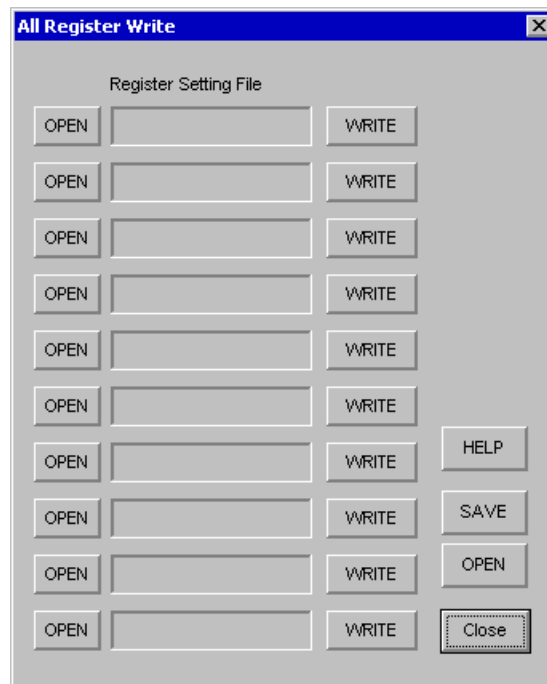

Figure 13. [F5] window

7-1. [OPEN] buttons on left side and [WRITE] button

- (1) Click [OPEN] button and select the register setting file (*.akr).
- (2) Click [WRITE] button, then the register setting is executed.

7-2. [SAVE] and [OPEN] buttons on right side

- [SAVE]: The register setting file names assign can be saved. The file name is *.ak5.
 [OPEN]: The register setting file names assign that are saved in *.ak5 are loaded.

7-3. Note

- (1) All files need to be in same folder used by [SAVE] and [OPEN] function on right side.
- (2) When the register setting is changed by [Save] Button in main window, the file should be loaded again in order to reflect the change.

MEASUREMENT RESULTS

[Measurement condition]

- Measurement unit : Audio Precision, System Two Cascade
- MCLK : 512fs (fs=48kHz), 256fs (fs=96kHz)
- BICK : 64fs
- fs : 48kHz, 96kHz
- Bit : 24bit
- Power Supply : AVDD = 5.0V, DVDD = CVDD = 3.3V
- Interface : DSP Data (10pin Header : PSIA)
- Temperature : Room

[Measurement Results]

Parameter	Result				Unit
	L1ch / R1ch	L2ch / R2ch	L3ch / R3ch	L4ch / R4ch	
ADC Analog Input Characteristics:					
S/(N+D): Filter=none (fs=48kHz, -1dBFS, BW=20kHz)	90.2 / 90.7	90.2 / 90.8	90.2 / 90.7	90.2 / 90.7	dB
	(fs=96kHz, -1dBFS, BW=40kHz) 91.3 / 91.9	91.3 / 91.9	91.3 / 91.9	91.1 / 91.7	dB
D-Range: Filter=A-weighted (fs=48kHz, -60dBFS, BW=20kHz)	101.7 / 101.9	101.8 / 101.9	101.7 / 101.9	101.7 / 102.0	dB
	(fs=96kHz, -60dBFS, BW=40kHz) 102.6 / 102.8	102.6 / 102.8	102.6 / 102.8	102.0 / 102.2	dB
S/N: Filter=A-weighted (fs=48kHz, No signal, BW=20kHz)	101.8 / 102.1	101.9 / 102.1	101.9 / 102.1	101.9 / 102.1	dB
	(fs=96kHz, No signal, BW=40kHz) 102.7 / 102.9	102.7 / 102.9	102.7 / 102.9	102.3 / 102.5	dB

[ADC Plot: fs=48kHz]

AKM

AK5367A THD+N vs. Input Level
AVDD=5V, DVDD=CVDD=3.3V, fs=48kHz, MCLK=512fs, fin=1kHz

Figure 14. THD+N vs. Input Level

AKM

AK5367A THD+N vs. Input Frequency
AVDD=5V, DVDD=CVDD=3.3V, fs=48kHz, MCLK=512fs, -1dBFS input

Figure 15. THD+N vs. Input Frequency

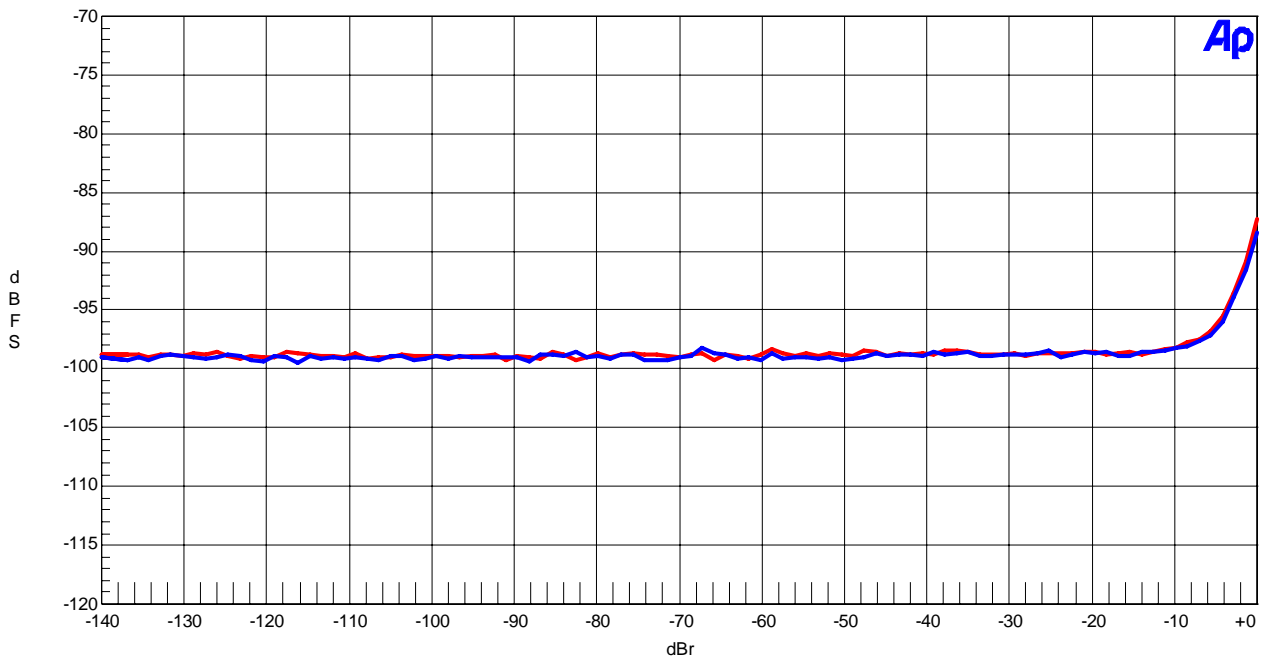
AKM

AK5367A Linearity
 AVDD=5V, DVDD=CVDD=3.3V, fs=48kHz, MCLK=512fs, fin=1kHz

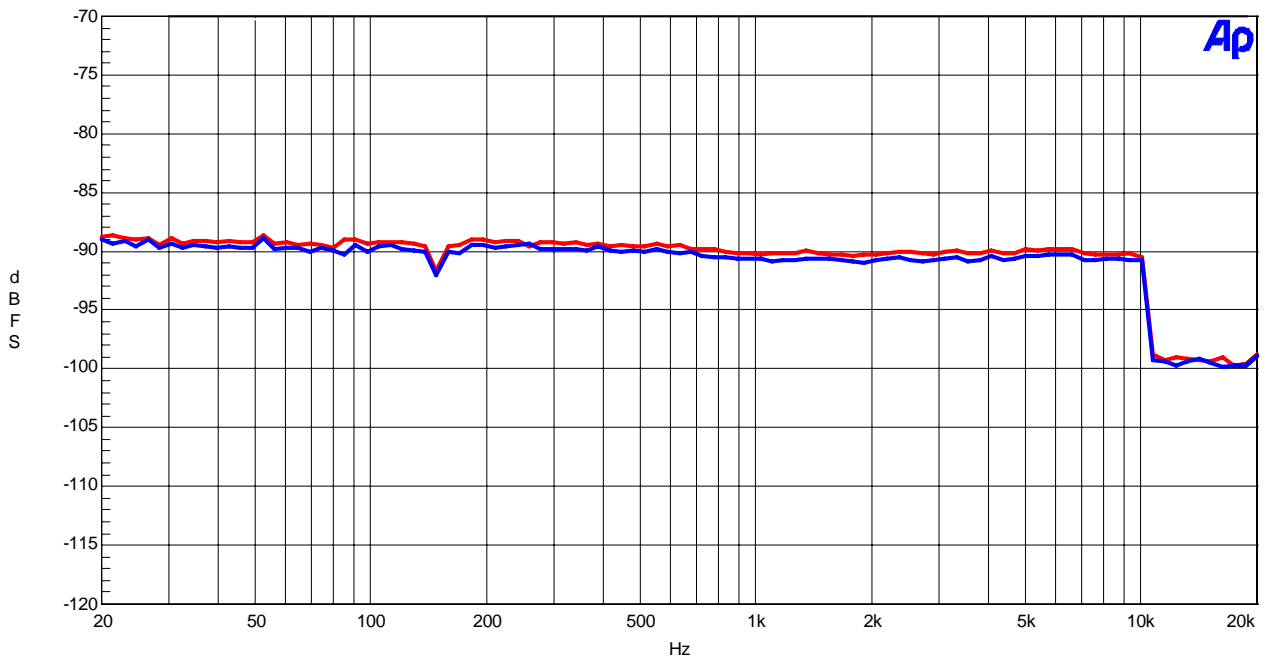
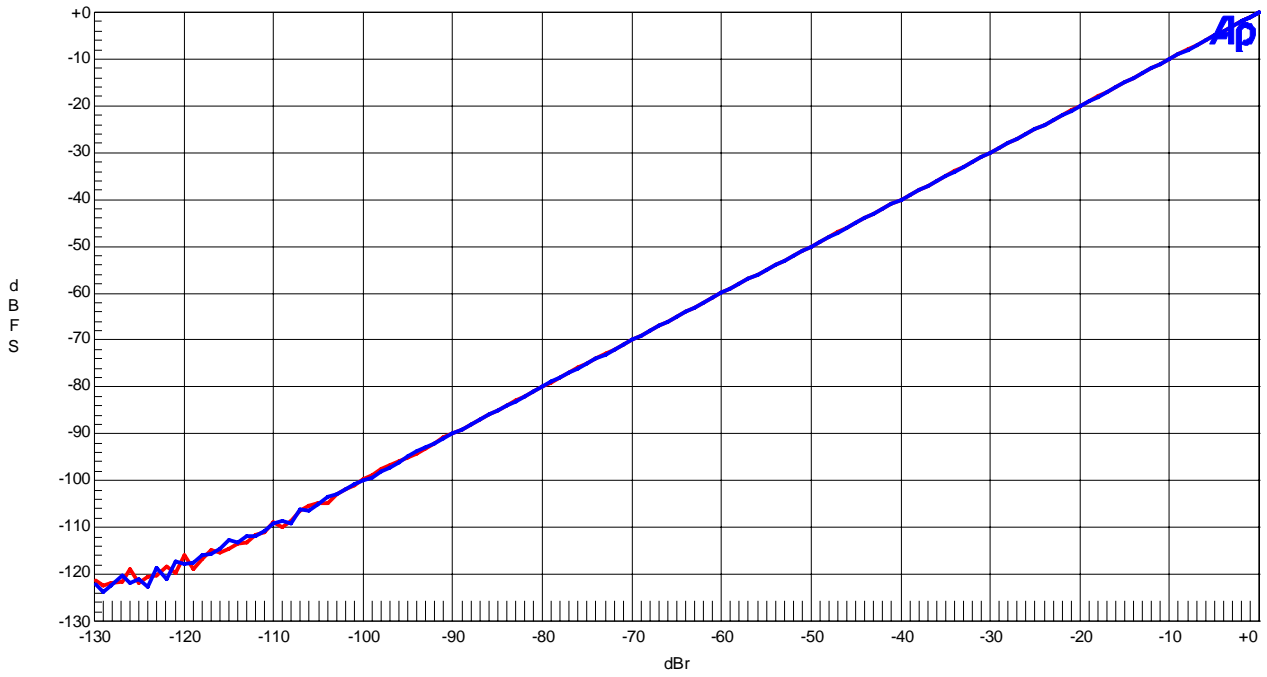

Figure 16. Linearity

AKM

AK5367A Frequency Response
 AVDD=5V, DVDD=CVDD=3.3V, fs=48kHz, MCLK=512fs, -1dBFS input

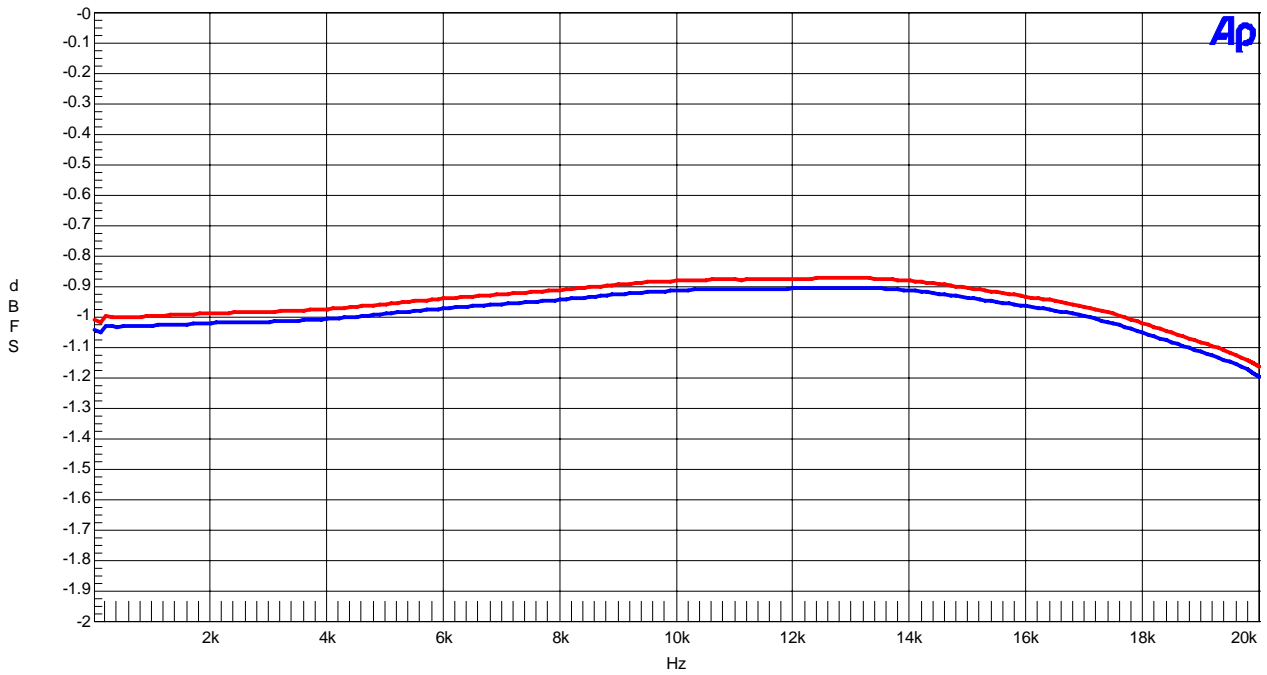

Figure 17. Frequency Response

AKM

AK5367A Crosstalk (Red=LIN1, Blue=RIN1)
 AVDD=5V, DVDD=CVDD=3.3V, fs=48kHz, MCLK=512fs, -1dBFS input

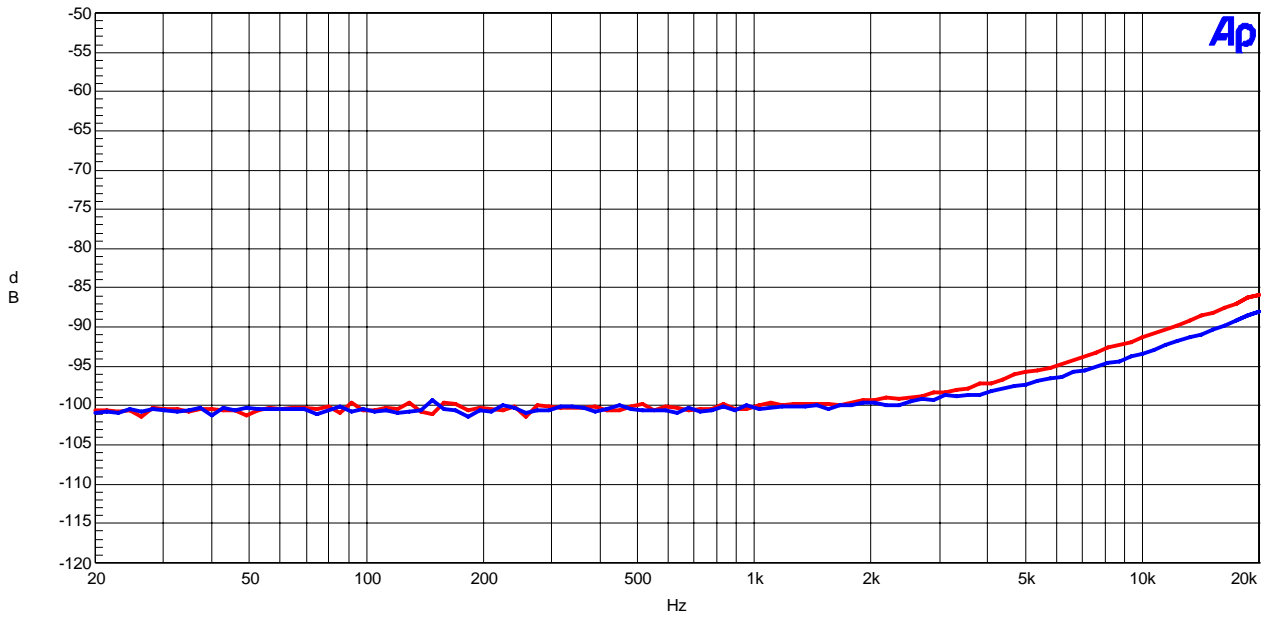

Figure 18. Crosstalk

AKM

AK5367A FFT
 AVDD=5V, DVDD=CVDD=3.3V, fs=48kHz, MCLK=512fs, -1dBFS input

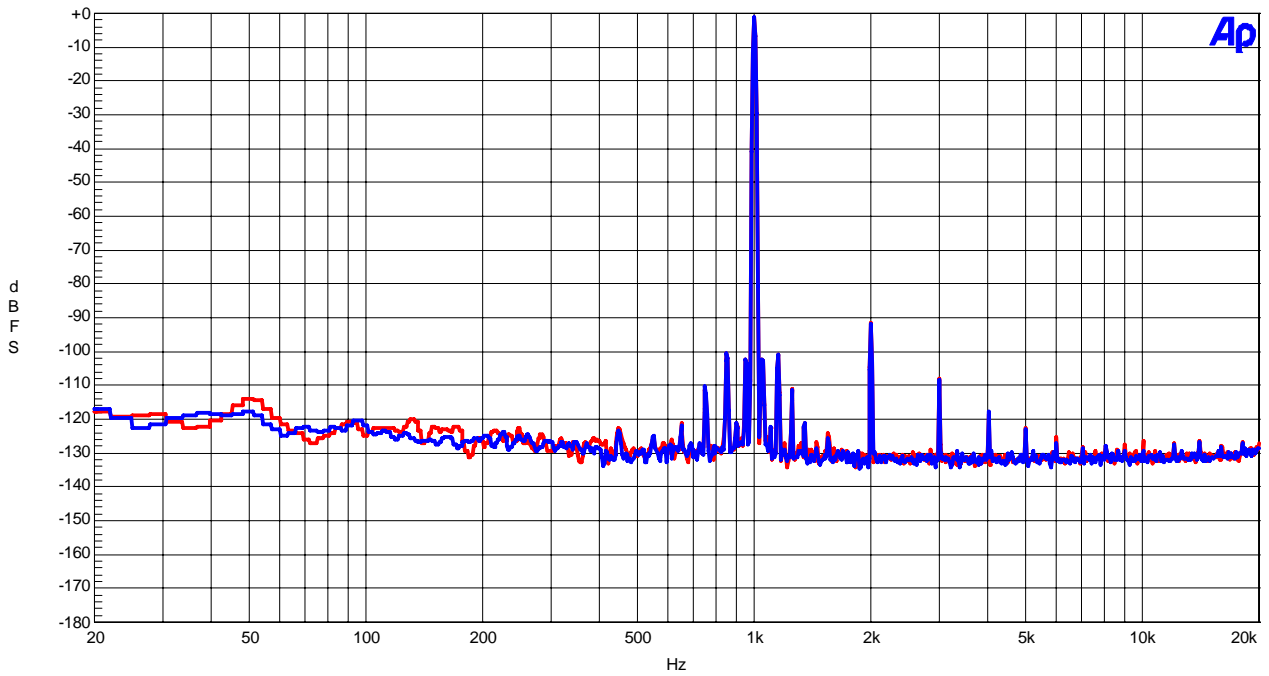

Figure 19. FFT Plot

AKM

AK5367A FFT
AVDD=5V, DVDD=CVDD=3.3V, fs=48kHz, MCLK=512fs, -60dBFS input

Figure 20. FFT Plot

AKM

AK5367A FFT
AVDD=5V, DVDD=CVDD=3.3V, fs=48kHz, MCLK=512fs, No signal input

Figure 21. FFT Plot

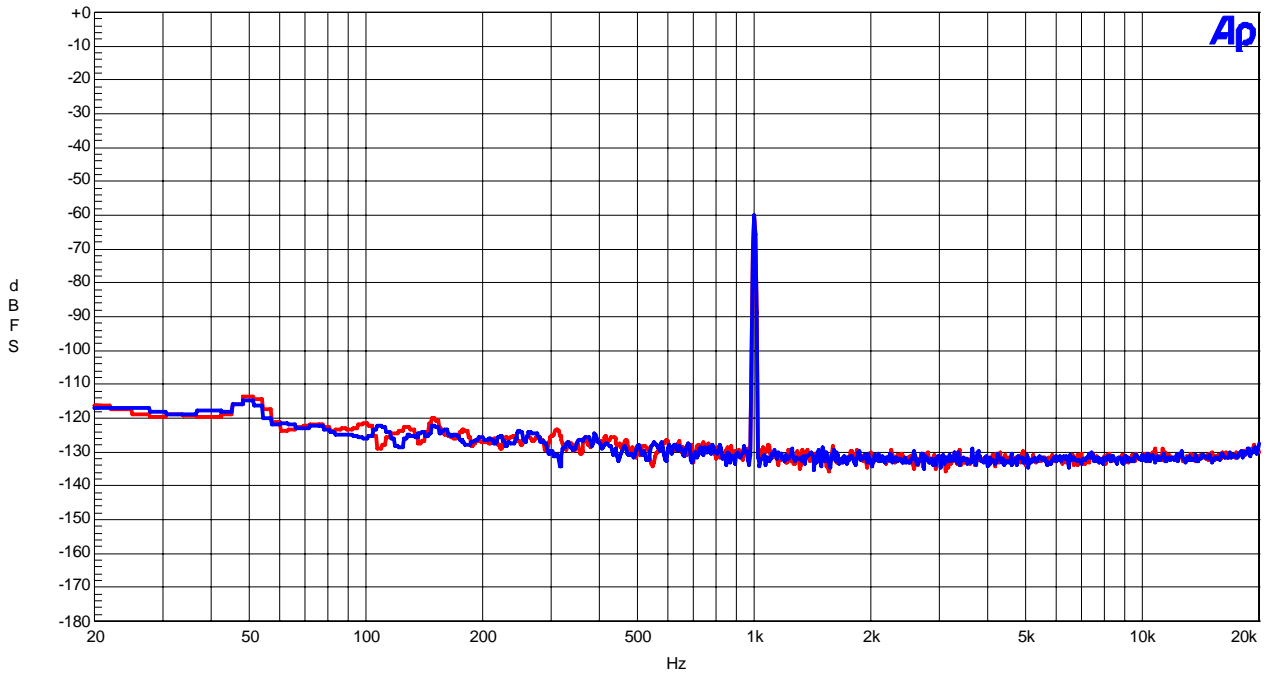
[ADC Plot: fs=96kHz]

AKM

AK5367A THD+N vs. Input Level
 AVDD=5V, DVDD=CVDD=3.3V, fs=96kHz, MCLK=256fs, fin=1kHz

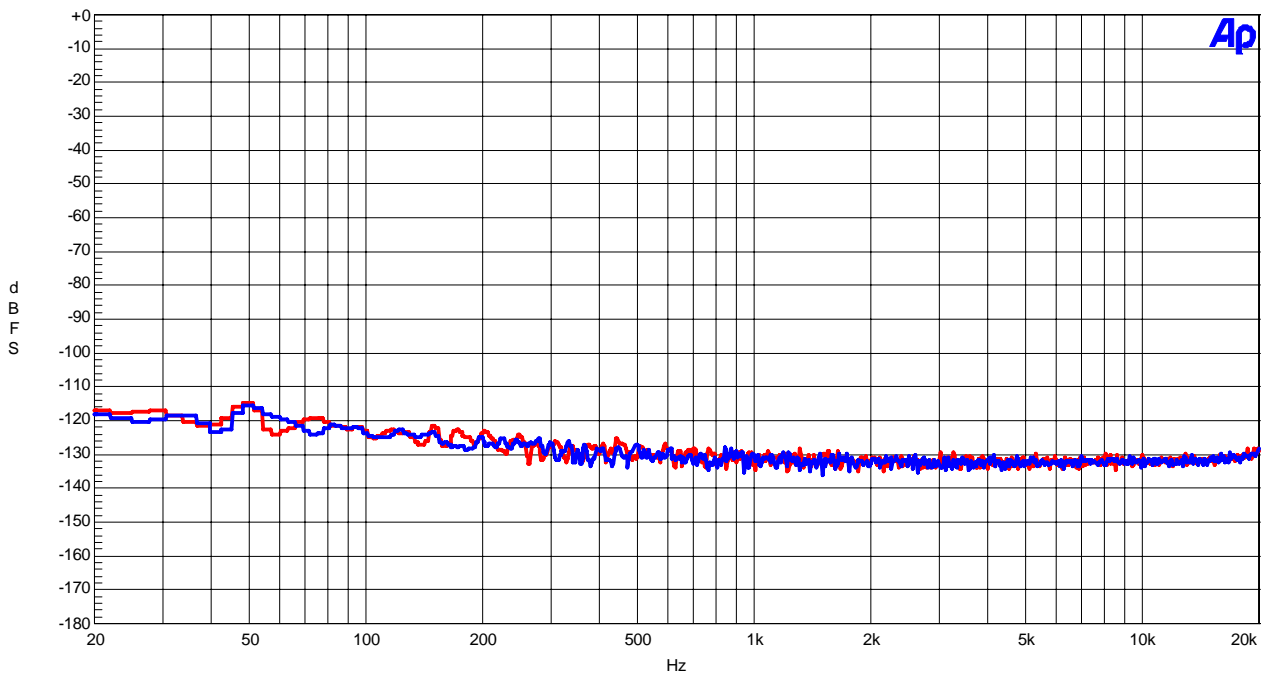
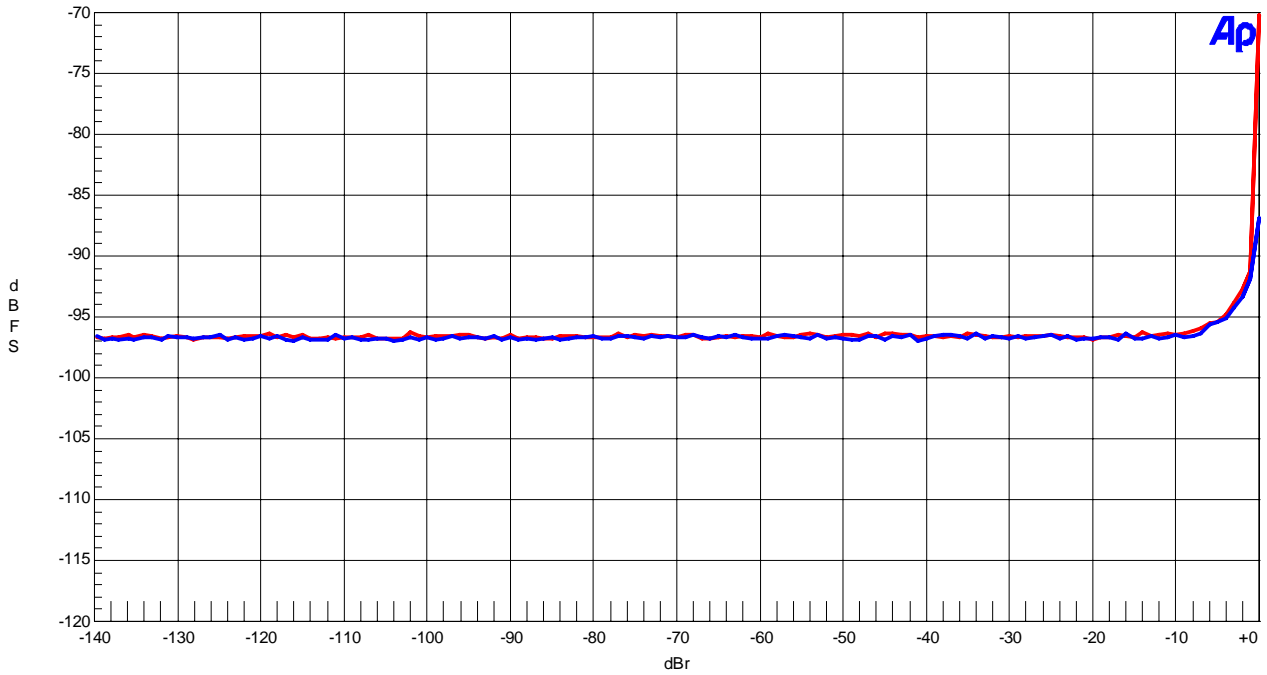

Figure 22. THD+N vs. Input Level

AKM

AK5367A THD+N vs. Input Frequency
 AVDD=5V, DVDD=CVDD=3.3V, fs=96kHz, MCLK=256fs, -1dBFS input

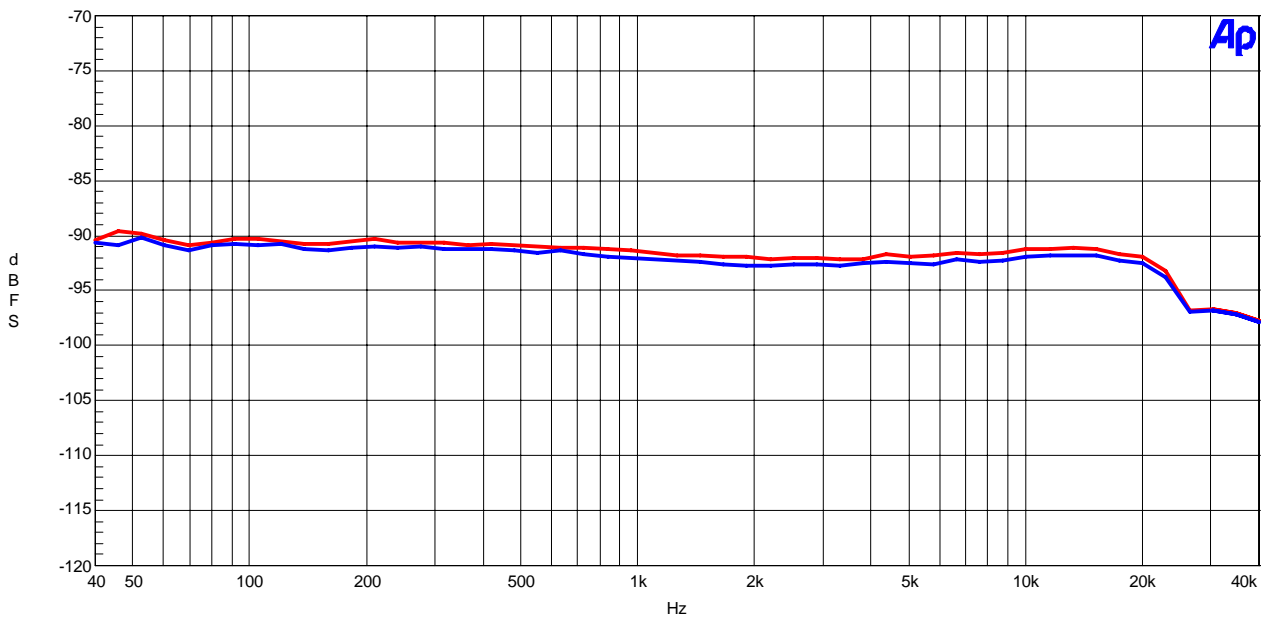

Figure 23. THD+N vs. Input Frequency

AKM

AK5367A Linearity
 AVDD=5V, DVDD=CVDD=3.3V, fs=96kHz, MCLK=256fs, fin=1kHz

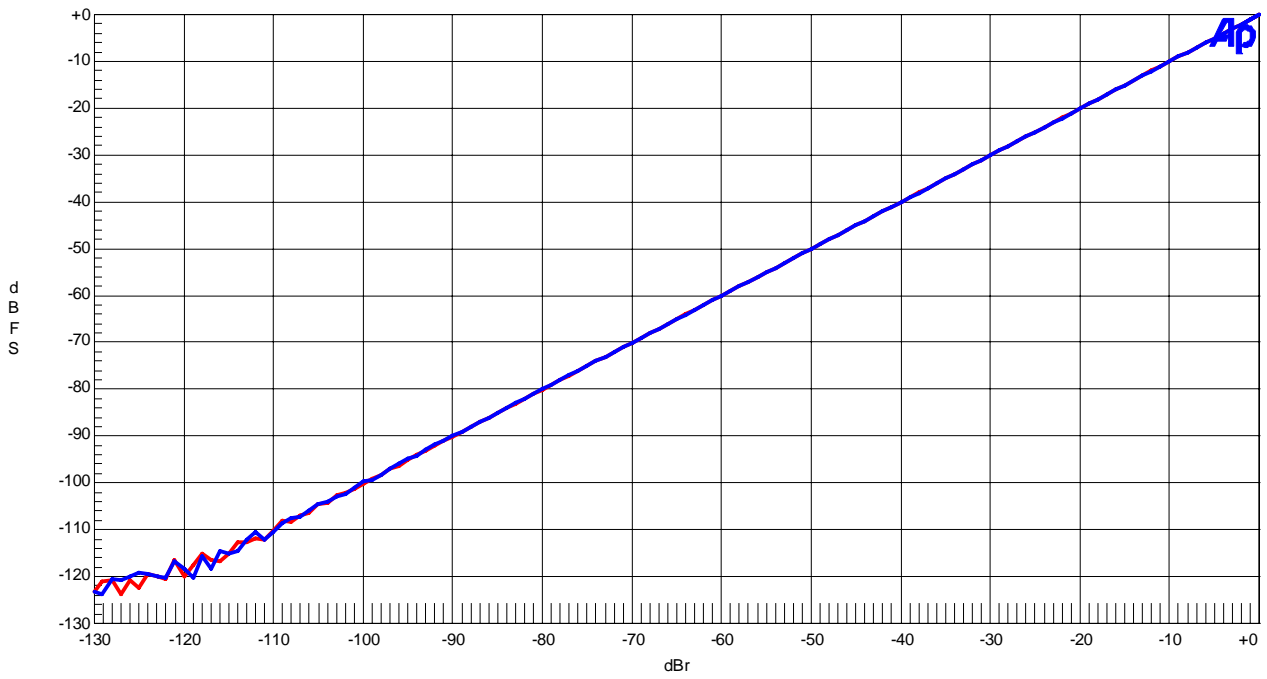

Figure 24. Linearity

AKM

AK5367A Frequency Response
 AVDD=5V, DVDD=CVDD=3.3V, fs=96kHz, MCLK=256fs, -1dBFS input

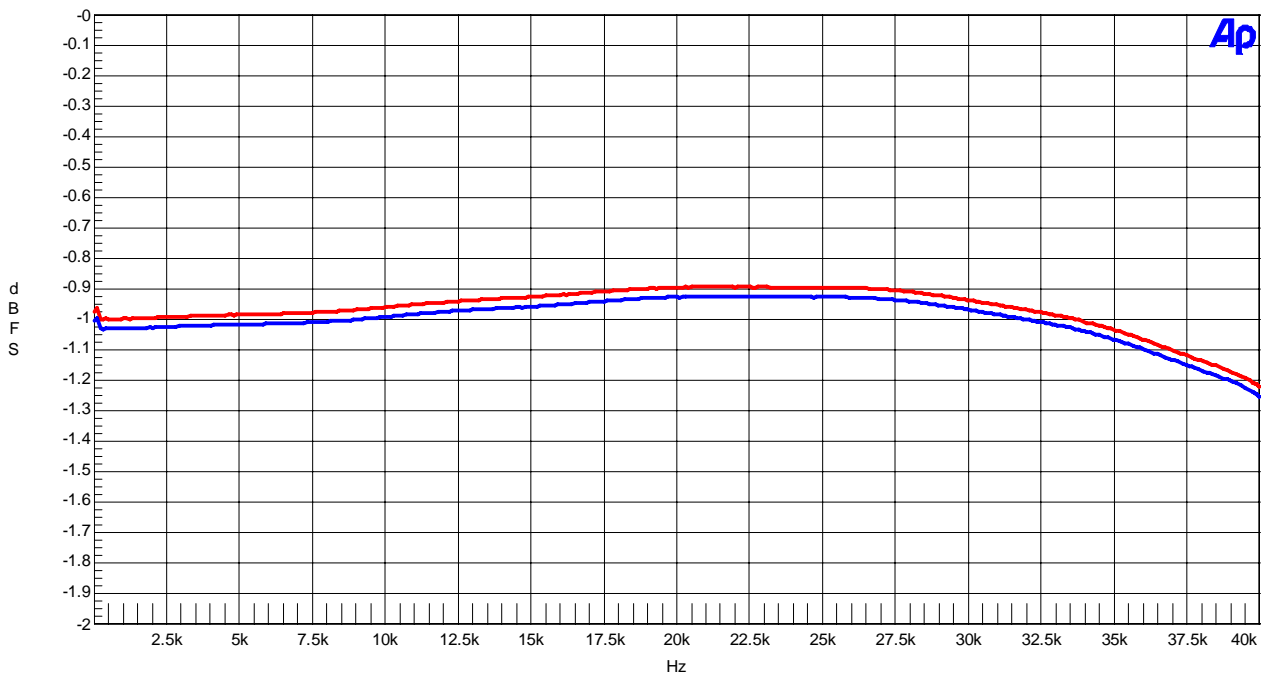

Figure 25. Frequency Response

AKM

AK5367A Crosstalk (Red=LIN1, Blue=RIN1)
 AVDD=5V, DVDD=CVDD=3.3V, fs=96kHz, MCLK=256fs, -1dBFS input

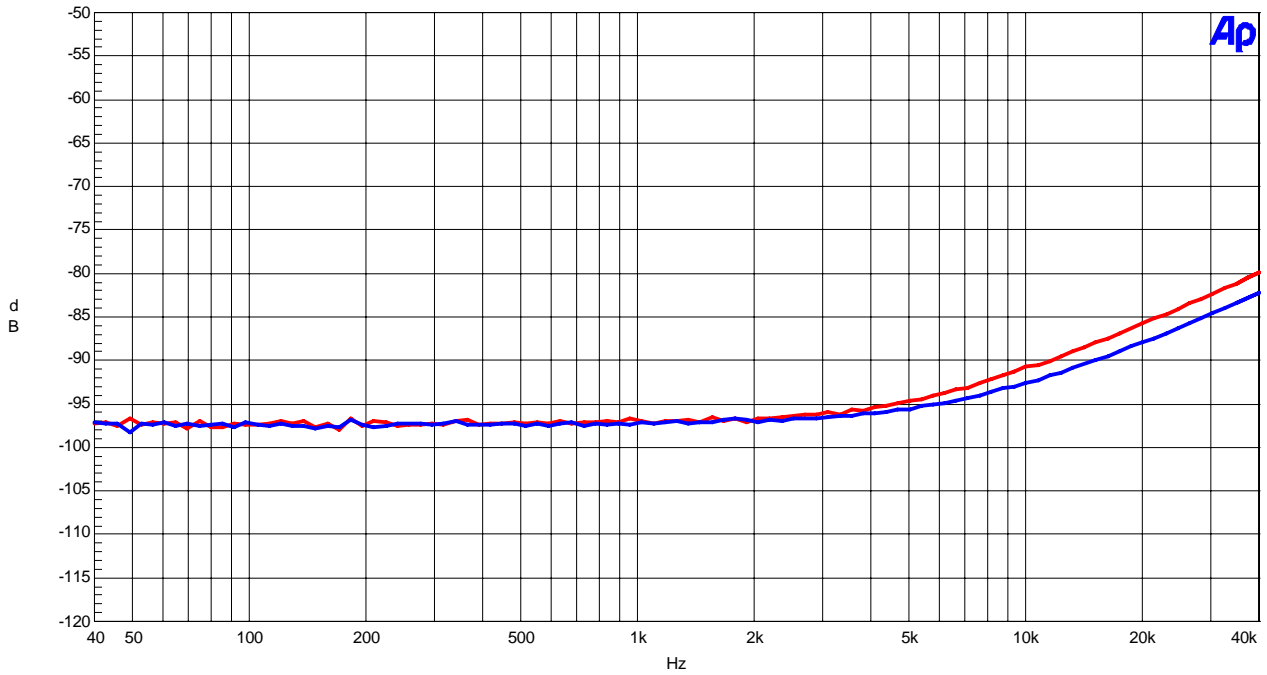

Figure 26. Crosstalk

AKM

AK5367A FFT
 AVDD=5V, DVDD=CVDD=3.3V, fs=96kHz, MCLK=256fs, -1dBFS input

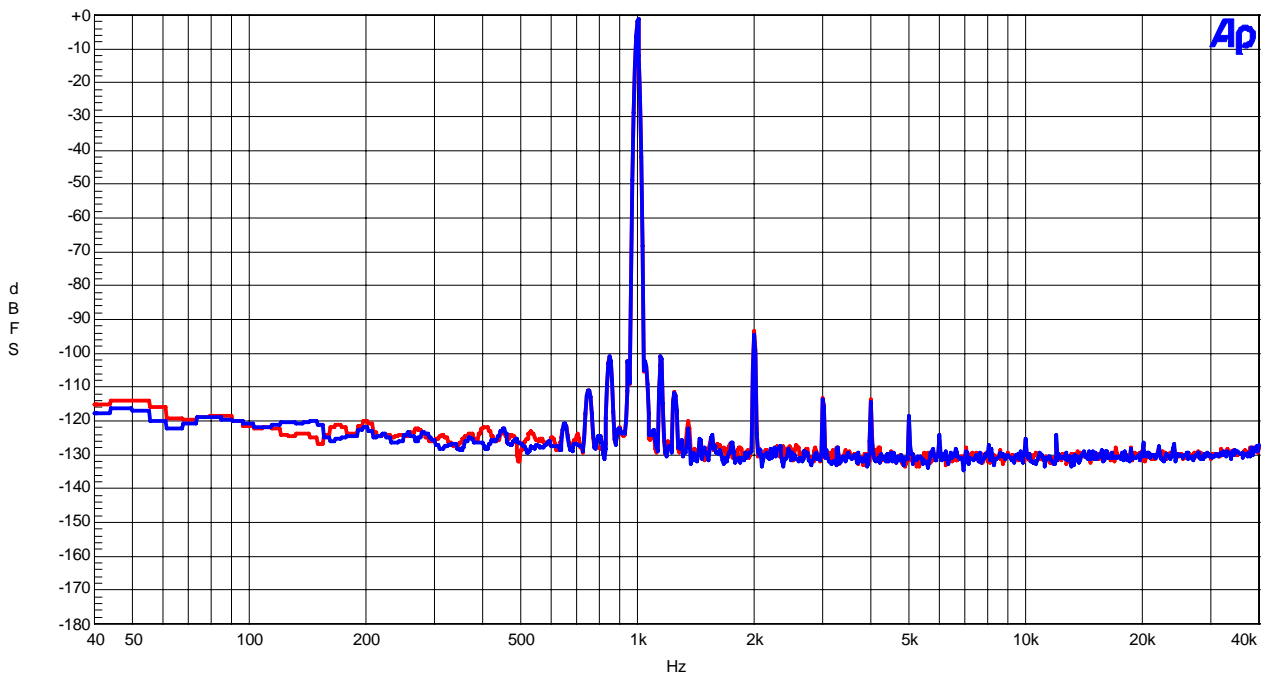

Figure 27. FFT Plot

AKM

AK5367A FFT
AVDD=5V, DVDD=CVDD=3.3V, fs=96kHz, MCLK=256fs, -60dBFS input

Figure 28. FFT Plot

AKM

AK5367A FFT
AVDD=5V, DVDD=CVDD=3.3V, fs=96kHz, MCLK=256fs, No signal input

Figure 29. FFT Plot

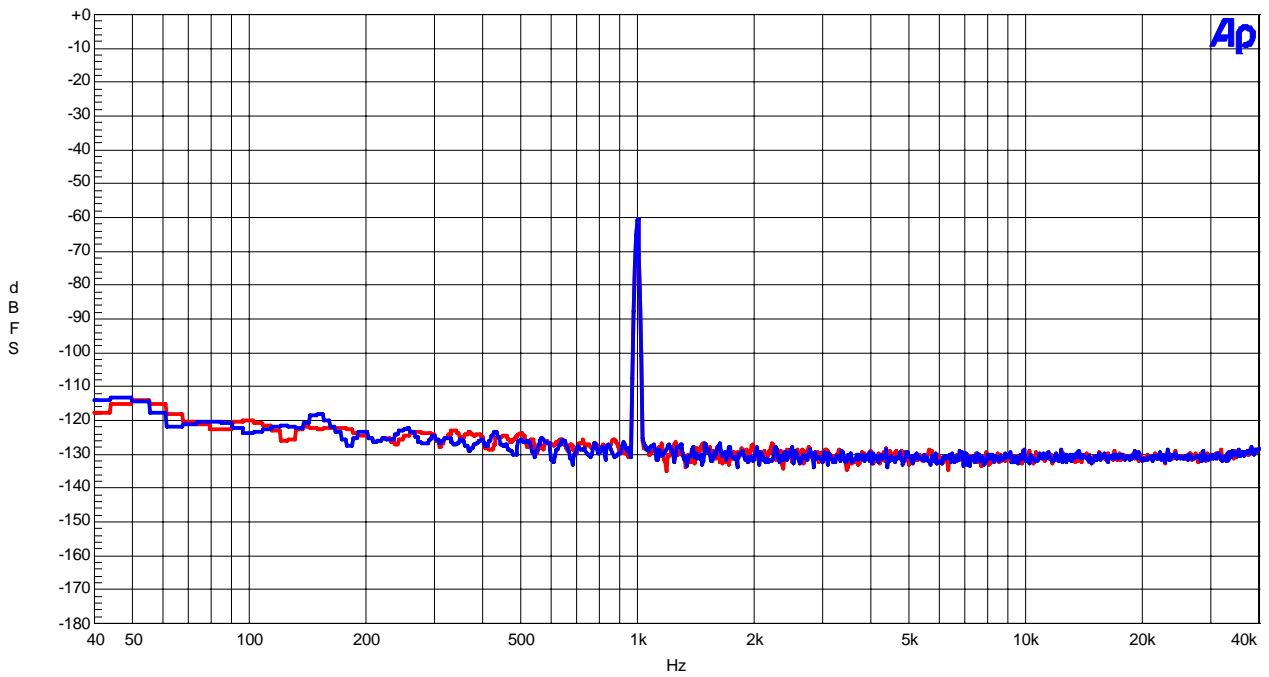
REVISION HISTORY

Date (YY/MM/DD)	Manual Revision	Board Revision	Reason	Page	Contents
08/06/09	KM095000	0	First Edition		

IMPORTANT NOTICE

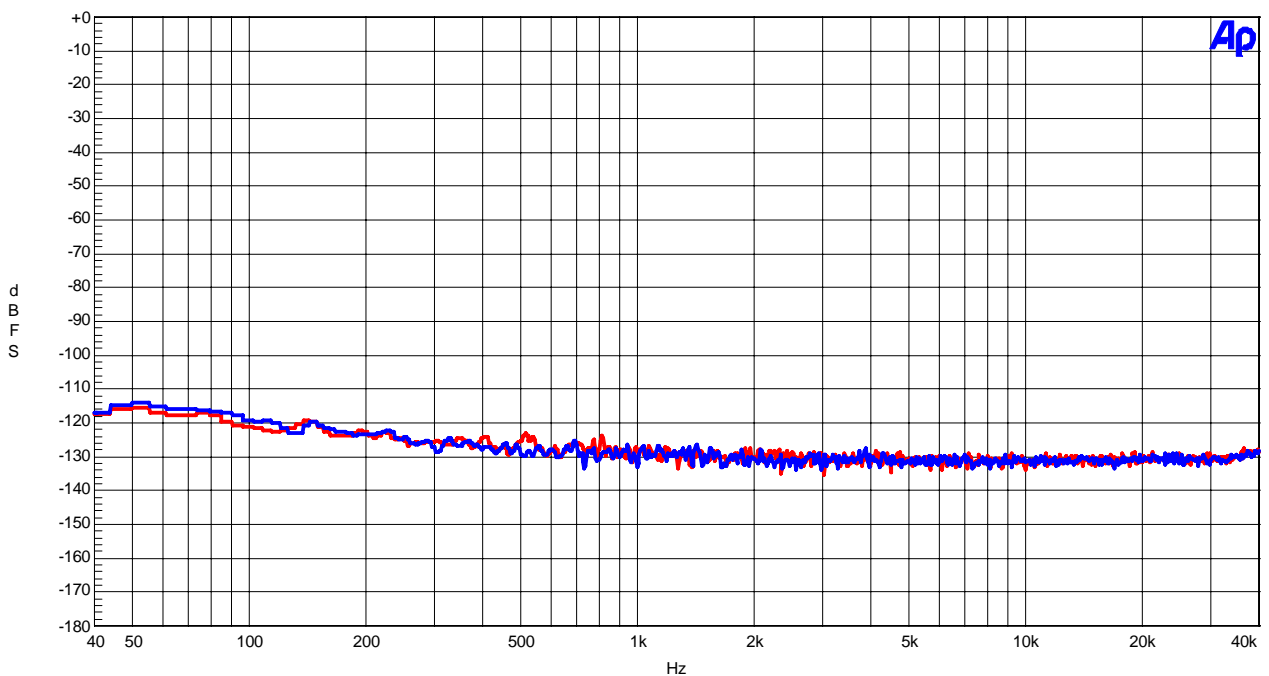
- These products and their specifications are subject to change without notice.
When you consider any use or application of these products, please make inquiries the sales office of Asahi Kasei EMD Corporation (AKEMD) or authorized distributors as to current status of the products.
- AKEMD assumes no liability for infringement of any patent, intellectual property, or other rights in the application or use of any information contained herein.
- Any export of these products, or devices or systems containing them, may require an export license or other official approval under the law and regulations of the country of export pertaining to customs and tariffs, currency exchange, or strategic materials.
- AKEMD products are neither intended nor authorized for use as critical components_{Note1} in any safety, life support, or other hazard related device or system_{Note2}, and AKEMD assumes no responsibility for such use, except for the use approved with the express written consent by Representative Director of AKEMD. As used here:
 - Note1) A critical component is one whose failure to function or perform may reasonably be expected to result, whether directly or indirectly, in the loss of the safety or effectiveness of the device or system containing it, and which must therefore meet very high standards of performance and reliability.
 - Note2) A hazard related device or system is one designed or intended for life support or maintenance of safety or for applications in medicine, aerospace, nuclear energy, or other fields, in which its failure to function or perform may reasonably be expected to result in loss of life or in significant injury or damage to person or property.
- It is the responsibility of the buyer or distributor of AKEMD products, who distributes, disposes of, or otherwise places the product with a third party, to notify such third party in advance of the above content and conditions, and the buyer or distributor agrees to assume any and all responsibility and liability for and hold AKEMD harmless from any and all claims arising from the use of said product in the absence of such notification.

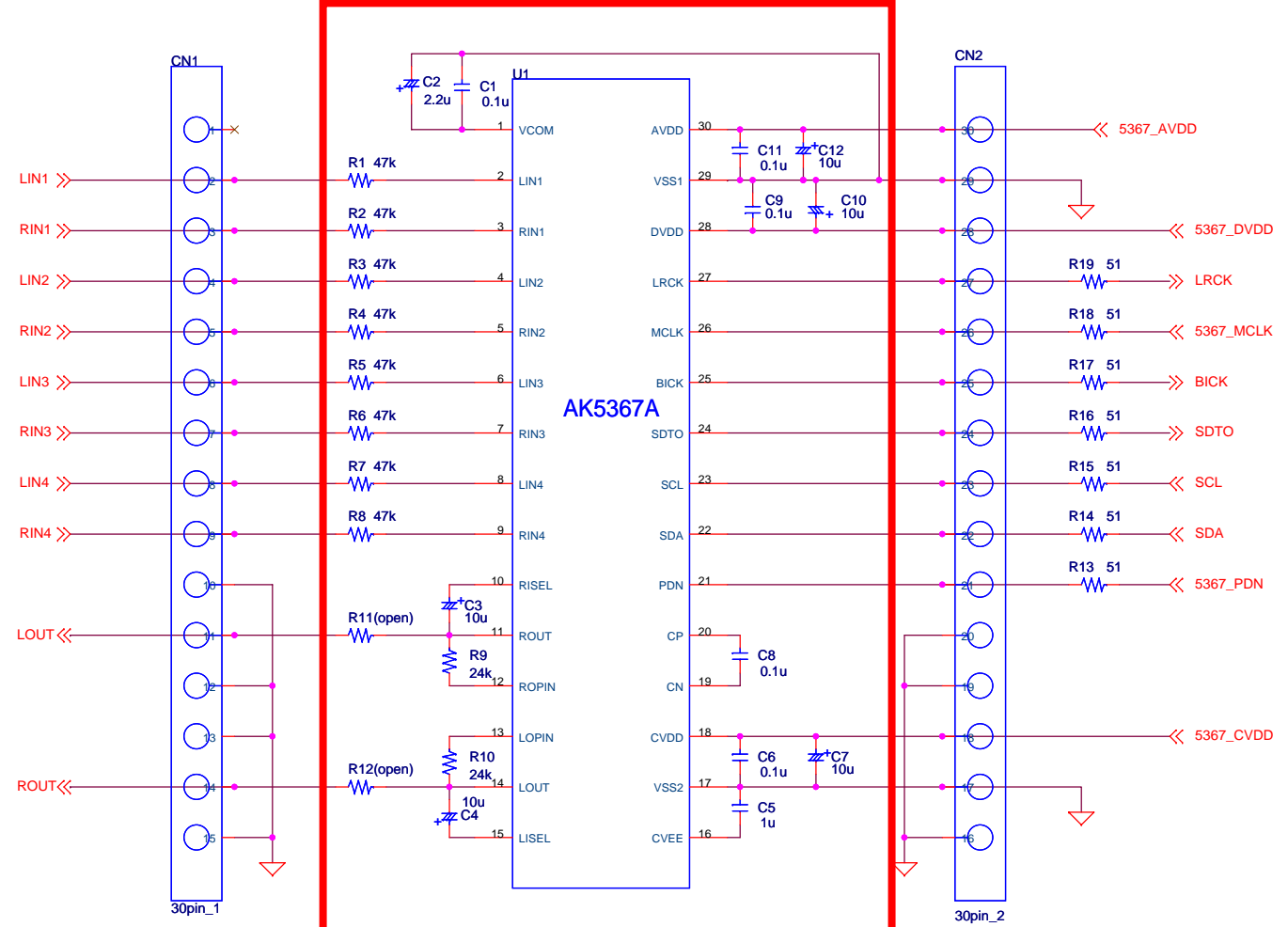
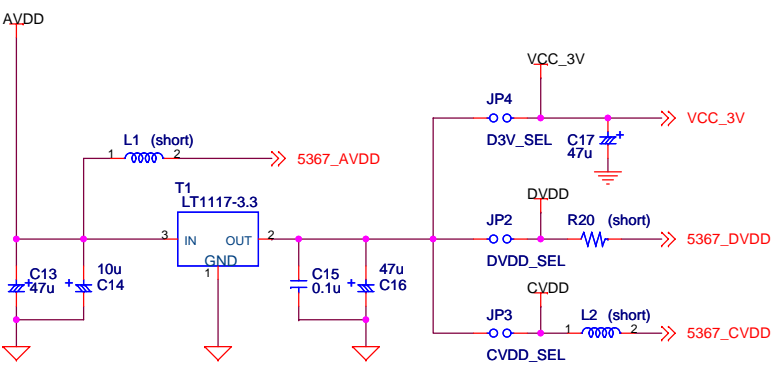
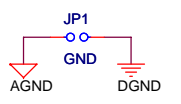
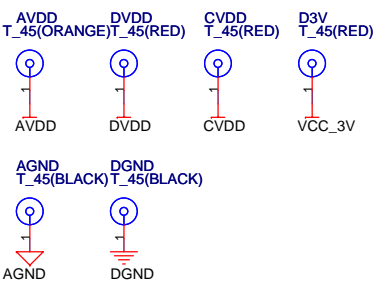

ALL unmount

Title			AKD5367A-A
Size	Document Number	AK5367A	
A3		Rev	0
Date: Tuesday, May 06, 2008		Sheet	1 of 4

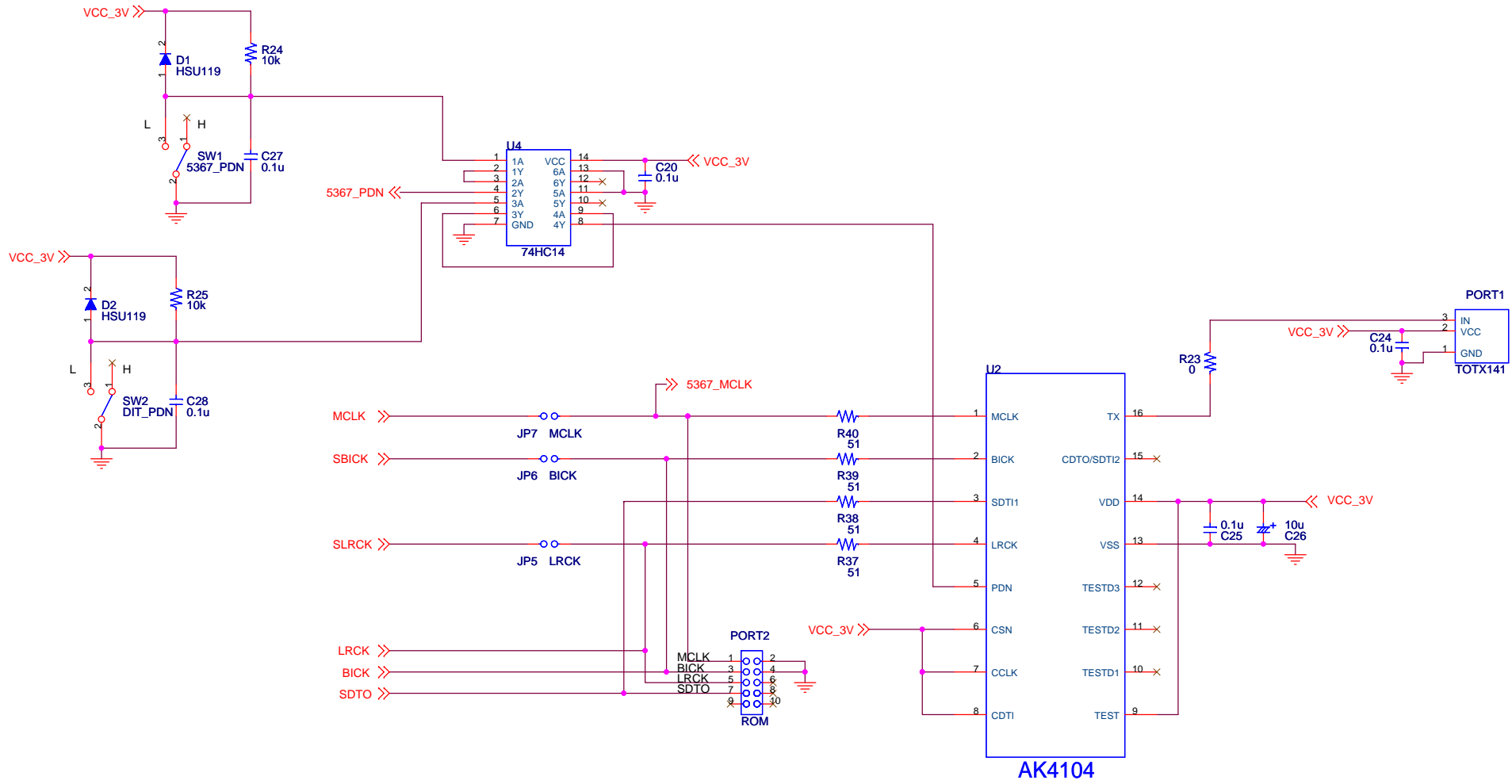

Title			AKD5367A-A		
Size	Document Number	Rev			0
A3	DIT AK4104				
Date:	Wednesday, May 07, 2008	Sheet	2	of	4

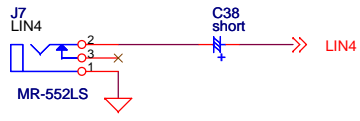
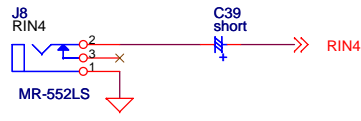
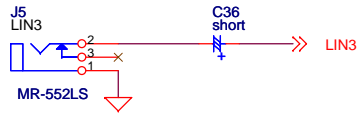
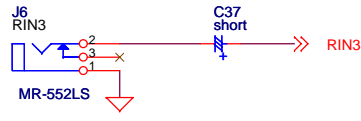
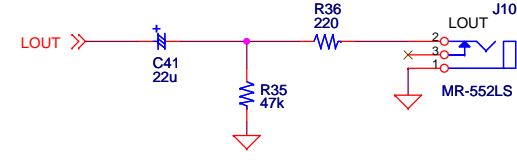
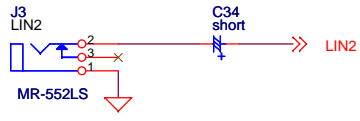
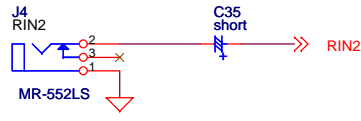
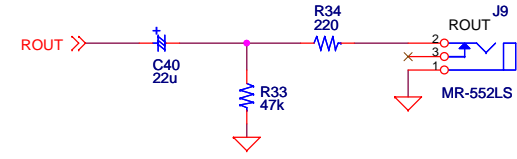
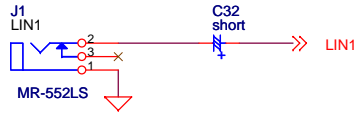
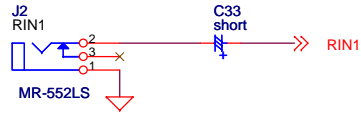

Title			AKD5367A-A		
Size	Document Number				Rev
A3	Input Output				0
Date:	Wednesday, May 07, 2008			Sheet	3 of 4

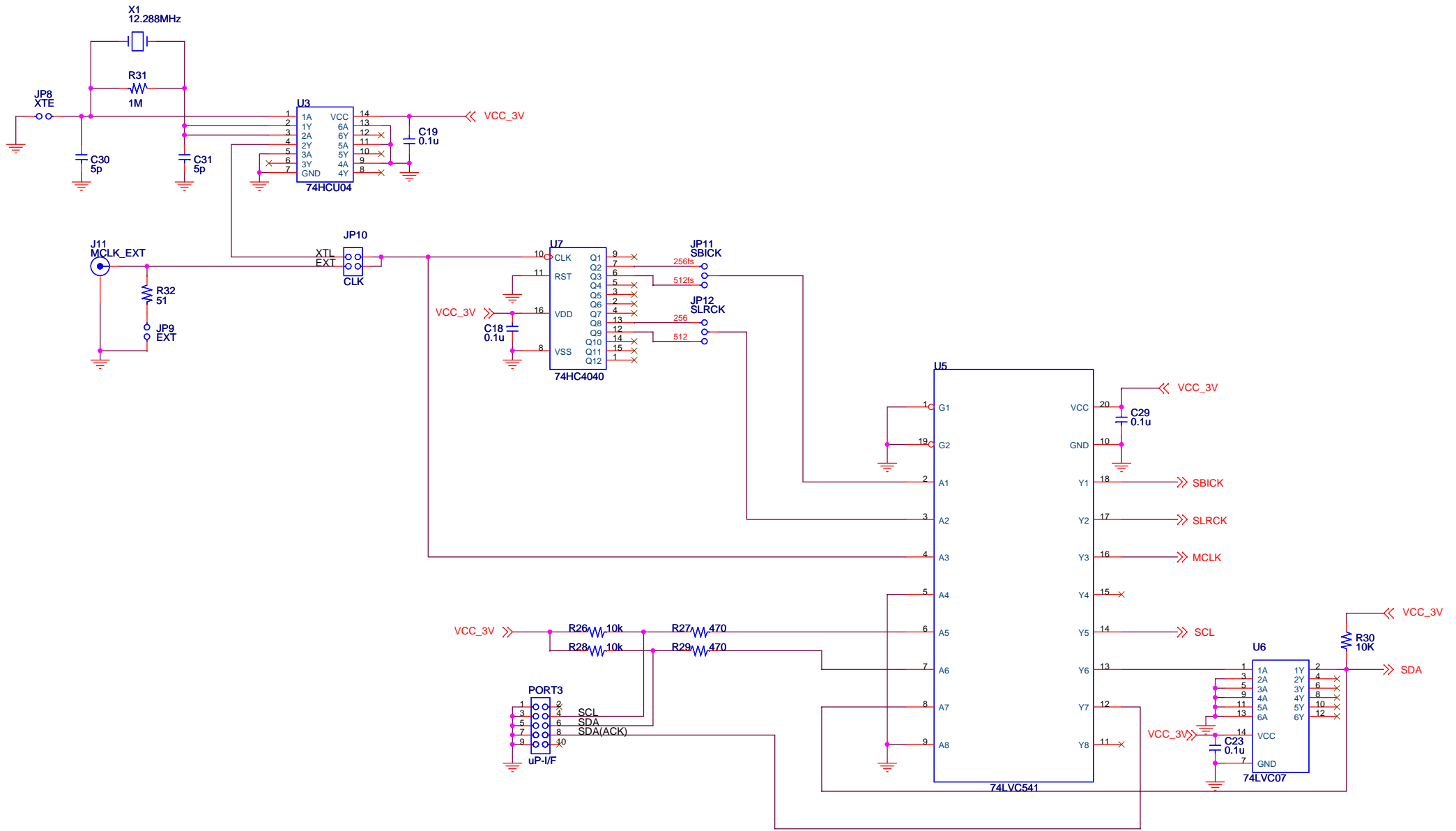

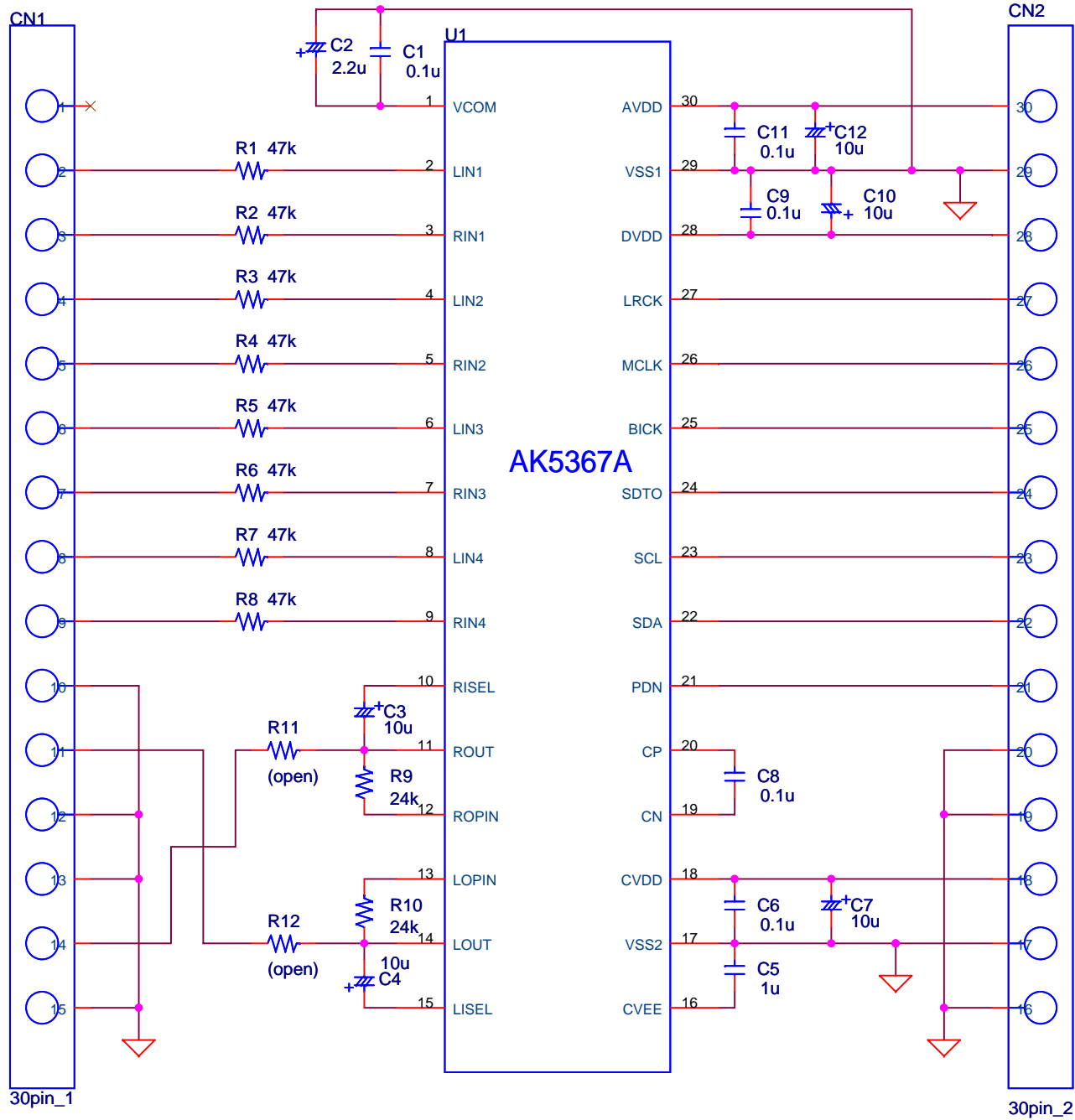

Title		
AKD5367A-A-30VSOP-SUB		
Size	Document Number	Rev
A4	AK5367A	0
Date:	Wednesday, May 07, 2008	Sheet 1 of 1

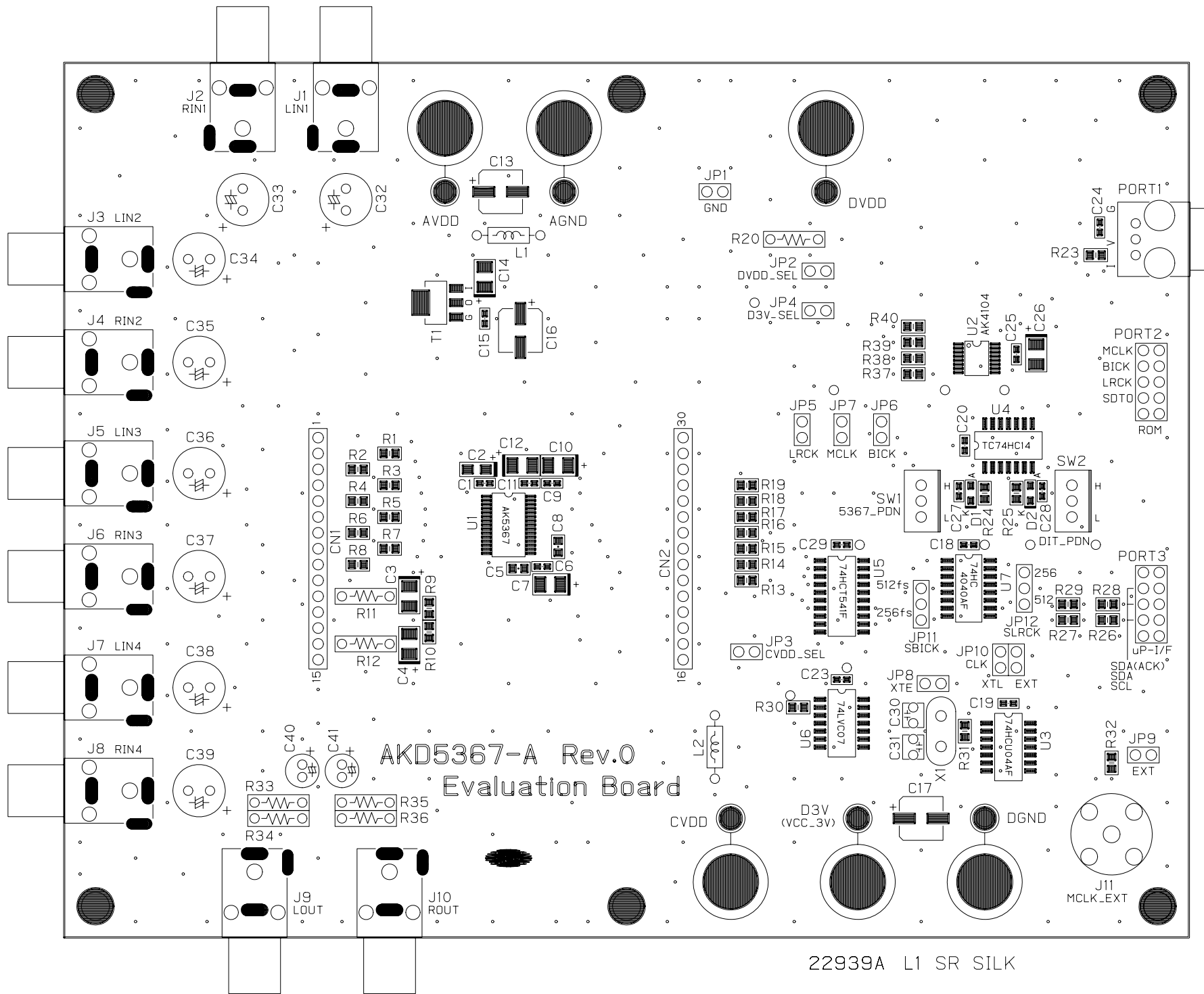

22939A L1 SR SILK

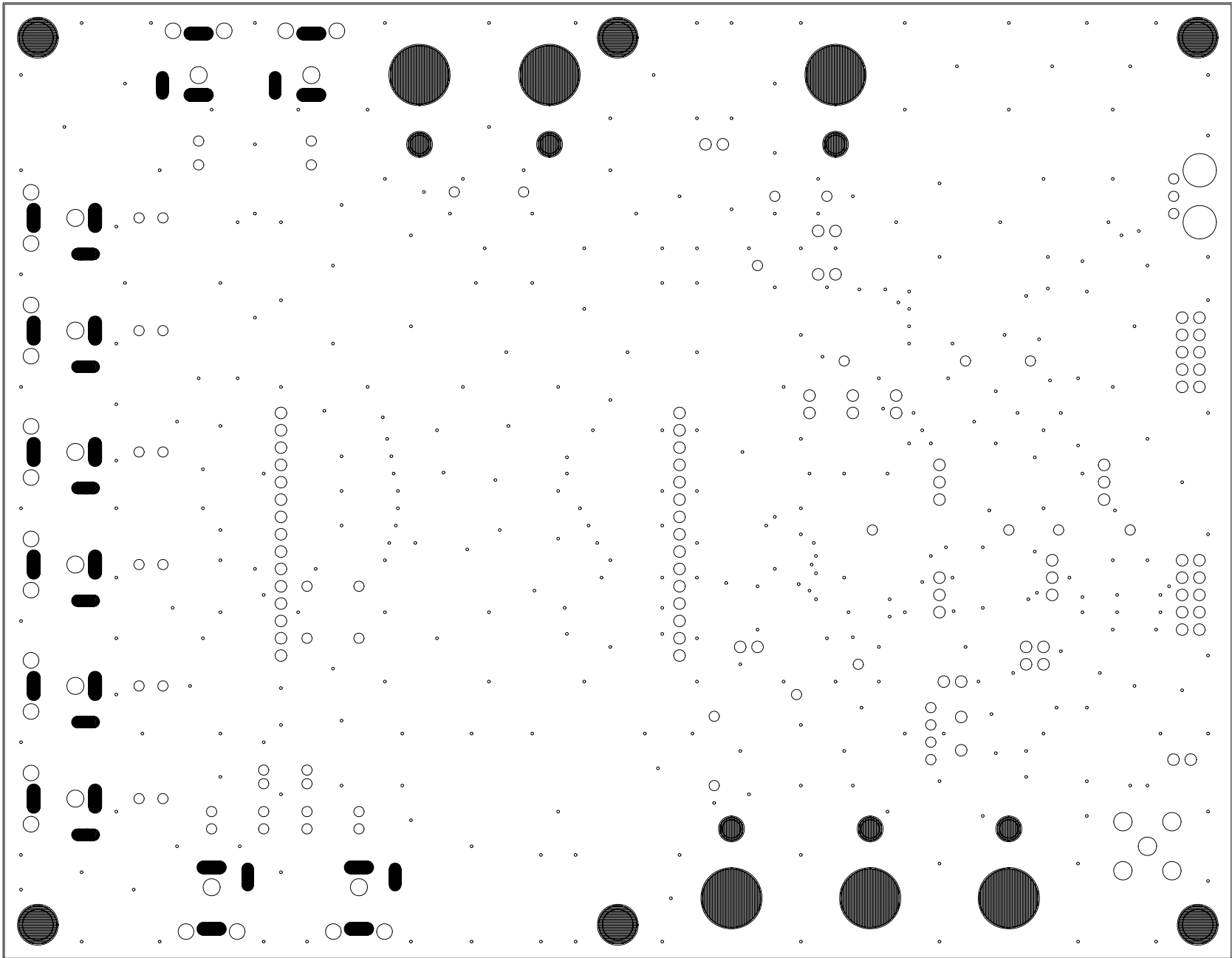

22939A L2 SR

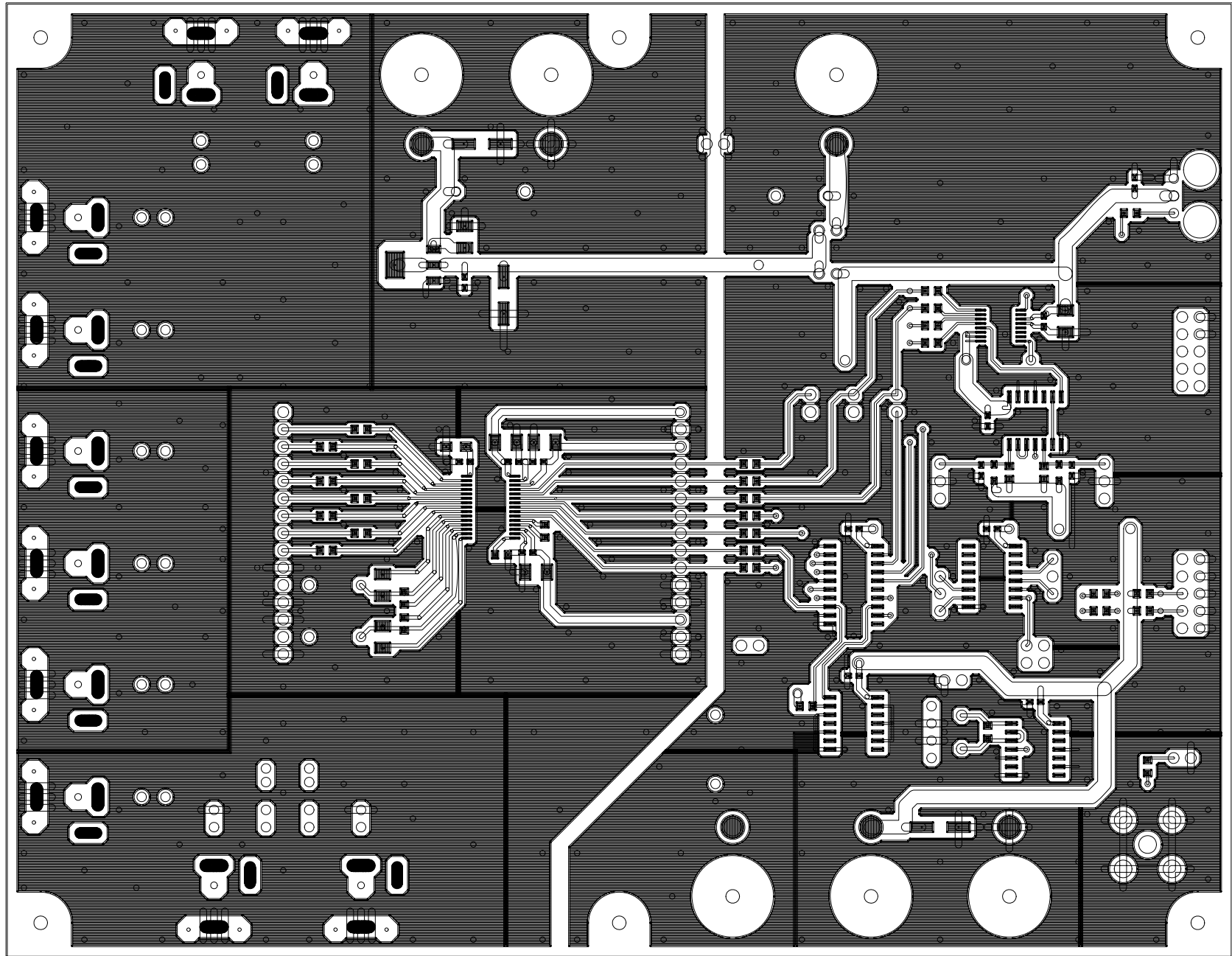

22939A L1

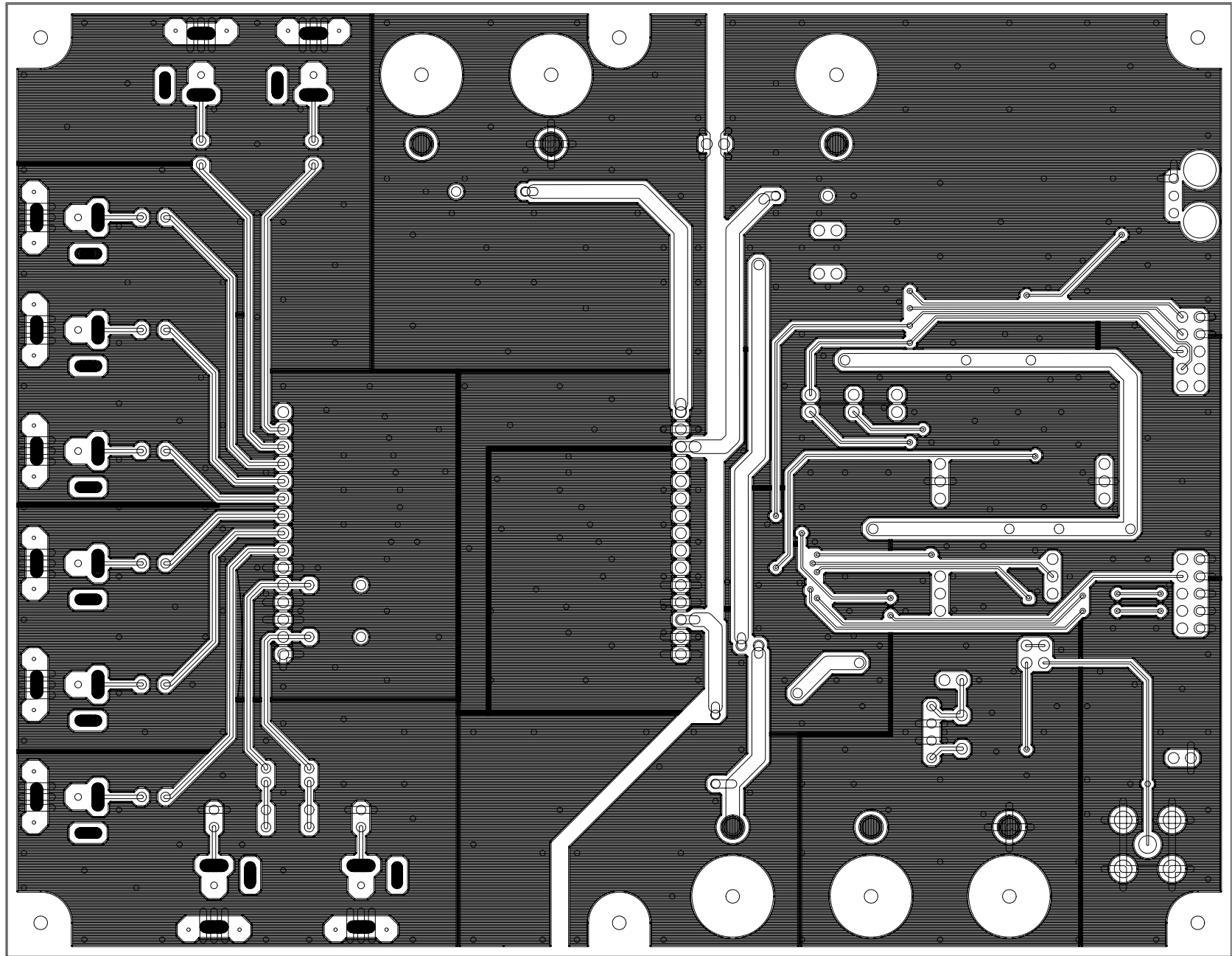

22939A L2

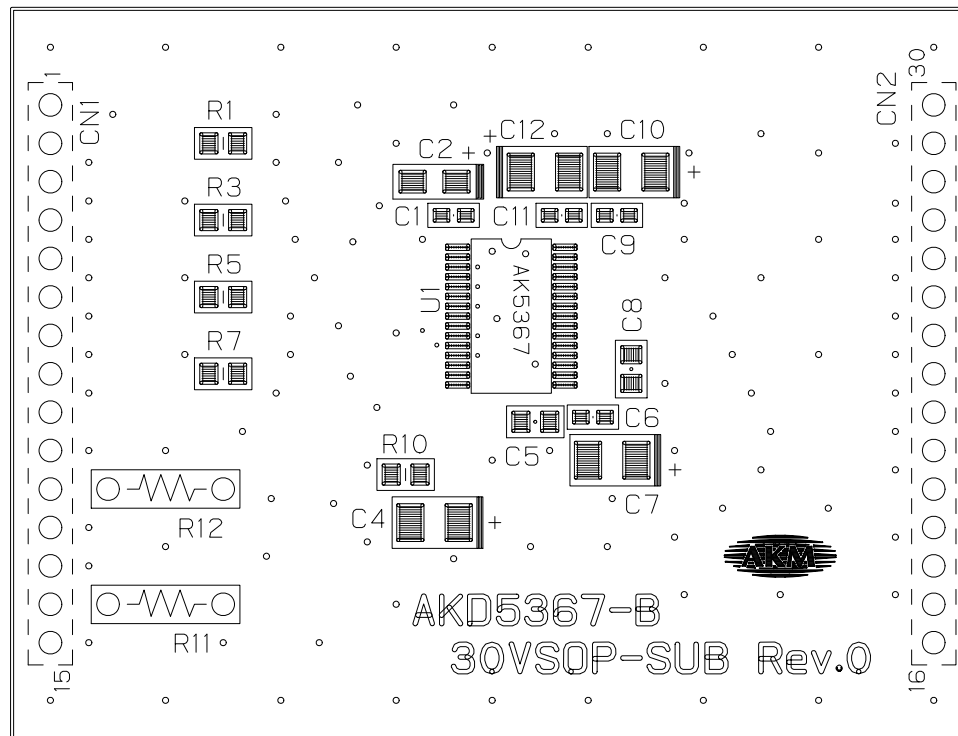

AKD5367-B-30VSOP-SUB Rev.0
08/04/10 23955 L1 SR SILK

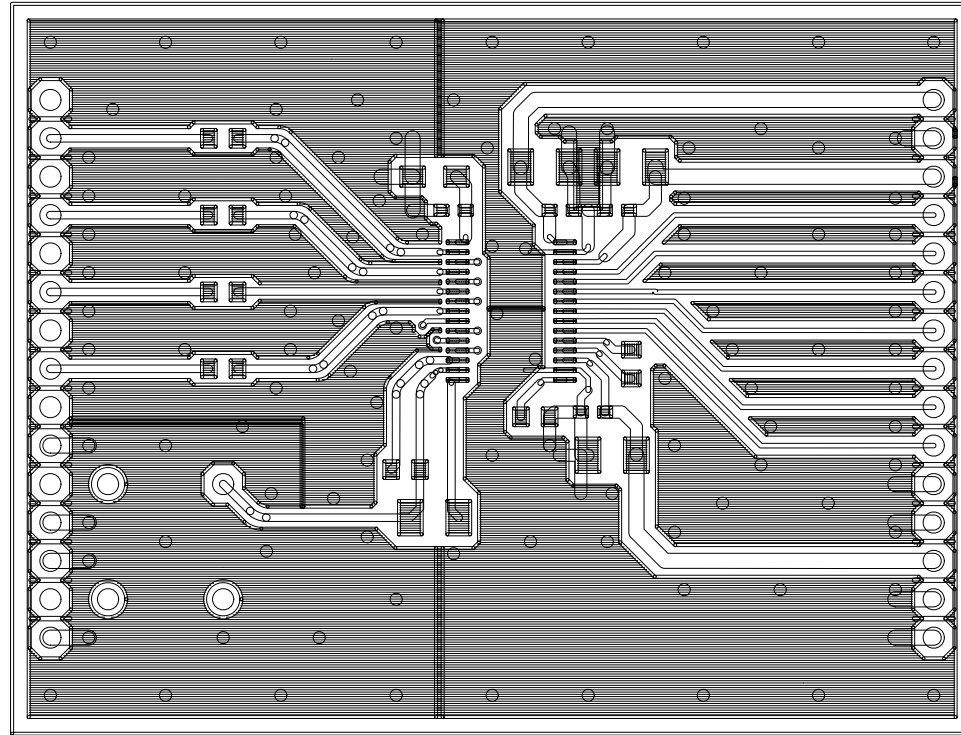

AKD5367-B-30VSOP-SUB Rev.0
08/04/10 23955 L1

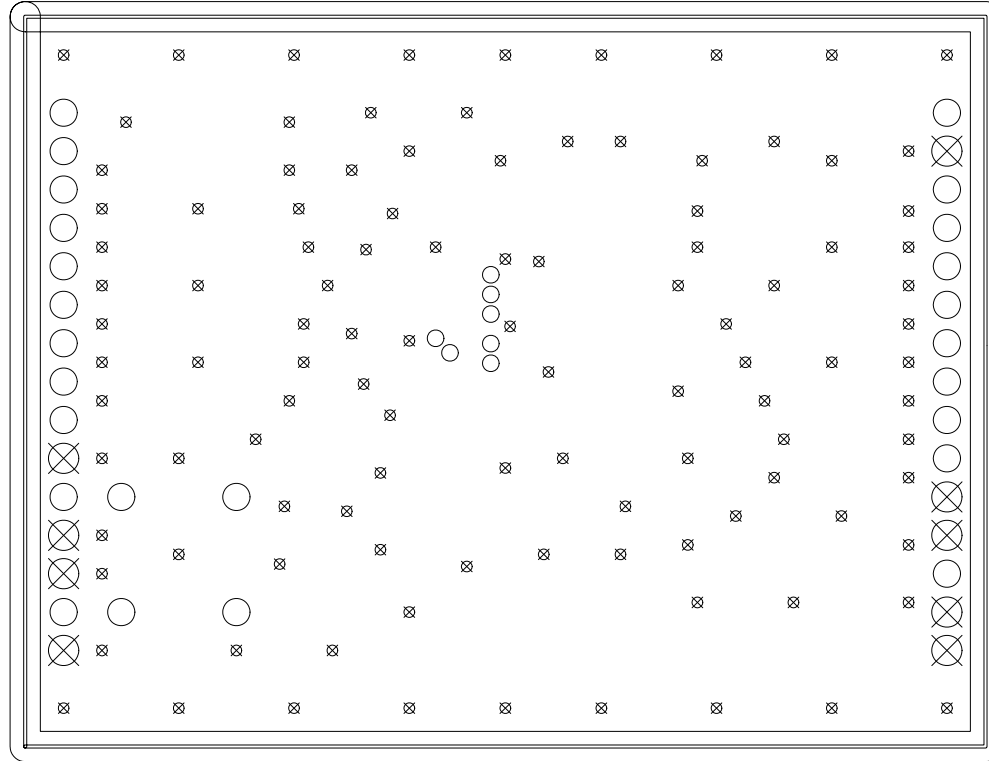

AKD5367-B-30VSOP-SUB Rev.0
08/04/10 23955 L2/L3 GND

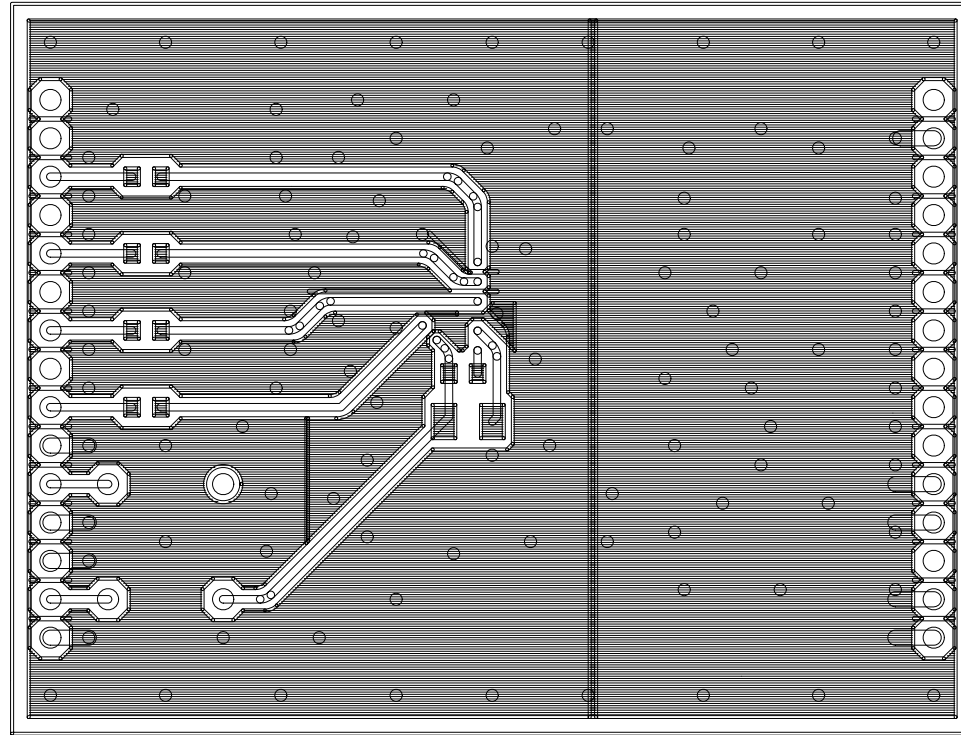

AKD5367-B-30VSOP-SUB Rev.0
08/04/10 23955 L4

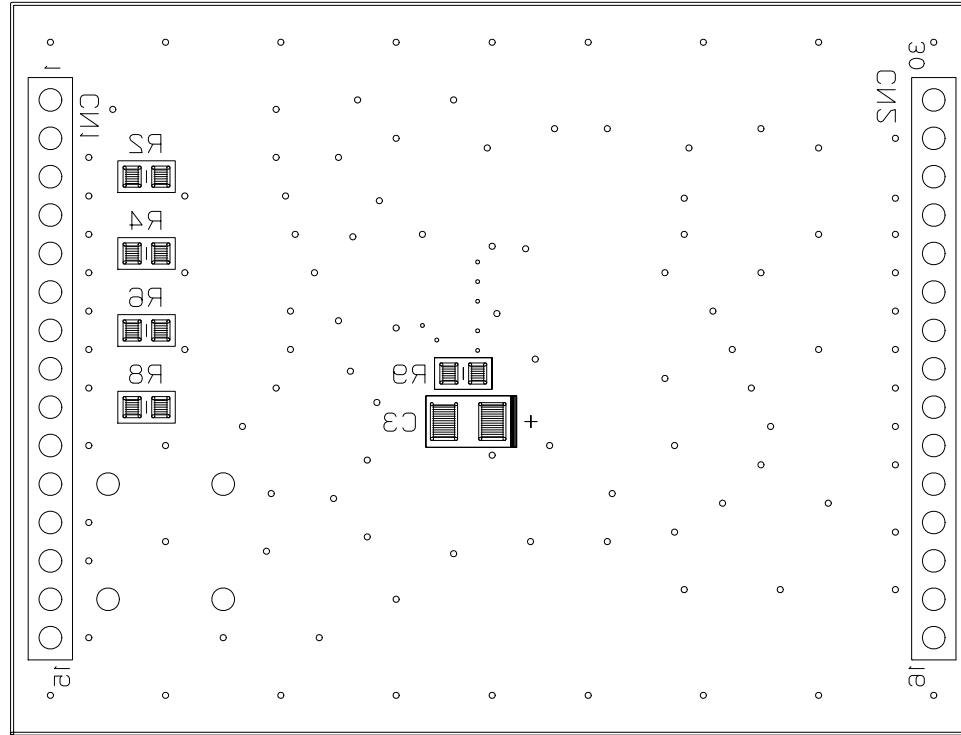

AKD5367-B-30VS0P-SUB Rev.0
 08/04/10 23955 L4 SR SILK