

San Ace 80 L CRL type

Long Life Counter Rotating Fan



Features

Long Life

The San Ace 80 CRL type has an expected life of 130,000 hours (approximately 15 years), about 3.3 times that of our conventional counter rotating fan,* making this fan ideal for equipment that must operate without maintenance for extended periods.

* : Specification of Model No. 9CRL0812P8G001.
Our conventional counter rotating fan is 80 x 80 x 80 mm "San Ace 80" CRA type, Model No. 9CRA0812P8G001.

80×80×80mm

Specifications

Model No.	Rated Voltage [V]	Operating Voltage Range [V]	PWM Duty Cycle [%]	Rated Current [A]	Rated Input [W]	Rated Speed [min ⁻¹]		Max. Air Flow [m ³ /min] [CFM]		Max. Static Pressure [Pa] [inchH ₂ O]		SPL [dB(A)]	Operating Temperature [°C]	Expected Life [h]
						Inlet	Outlet							
9CRL0812P8G001	12	10.8 to 13.2	100	5.3	63.6	12,000	11,300	4.5	158.9	1,150	4.62	76	-20 to +70	130,000/60°C
			0	0.2	2.4	2,000	1,900	0.74	26.1	31.9	0.13	30		

Note : PWM Frequency : 25kHz

Common Specifications

- Material Frame:Aluminum, Impeller: Plastics (Flammability: UL94V-1)
- Life Expectancy Varies for each model
(L10: Survival rate: 90% at 60°C, rated voltage, and continuously run in a free air state)
- Motor Protection System Current blocking function and Reverse polarity protection
- Dielectric Strength 50/60 Hz, 500VAC, 1 minute (between lead conductor and frame)
- Sound Pressure Level (SPL) Expressed as the value at 1m from air inlet side
- Operating Temperature Varies for each model (Non-condensing)
- Storage Temperature -30°C to +70°C (Non-Condensing)
- Lead Wire Inlet : ⊕Red ⊖Black Sensor: Yellow Control: Brown
Outlet : ⊕Orange ⊖Gray Sensor: Purple Control: White
- Mass Approx. 490g

Air Flow - Static Pressure Characteristics

• PWM Duty Cycle

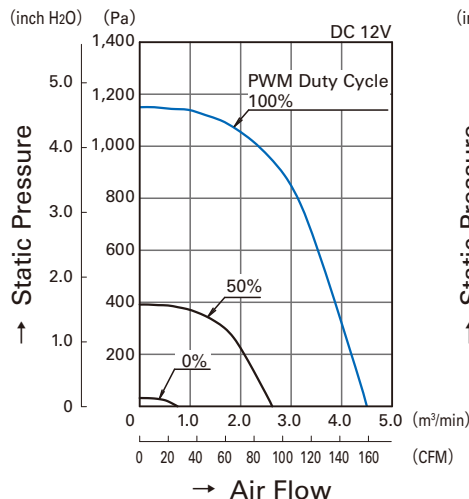

• Operating Voltage Range

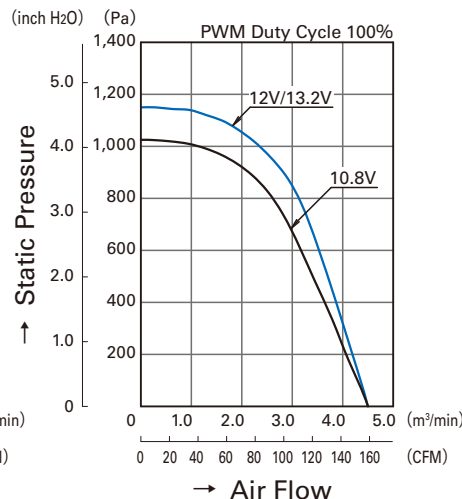

PWM Duty -

Speed Characteristics Example

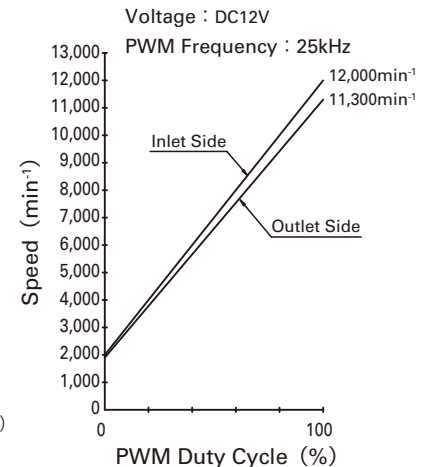

PWM Input Signal Example

Example of Connection Schematic

Input Signal Waveform

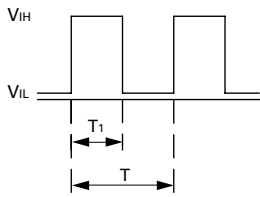

$V_{IH}=4.75V$ to $5.25V$

$V_{IL}=0V$ to $0.4V$

$$\text{PWM Duty Cycle (\%)} = \frac{T_1}{T} \times 100$$

$$\text{PWM Frequency 25 (kHz)} = \frac{1}{T}$$

Source Current : 2mA Max. at control voltage 0V

Sink Current : 2mA Max. at control voltage 5.25V

Control Terminal Voltage : 5.25V Max. (Open Circuit)

When the control lead wire is open, the fan speed is the same as the one at a PWM duty cycle of 100%.

Either TTL input, open collector or open drain can be used for PWM control input signal.

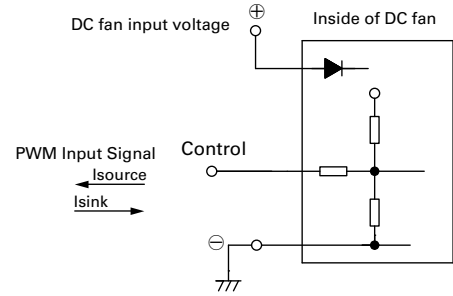

Specifications for Pulse Sensors

Output circuit : Open collector

$V_{CE} = +13.8V$ MAX.

$I_c = 5mA$ MAX. [$V_{CE(SAT)} = 0.6V$ MAX.]

Inside of DC fan

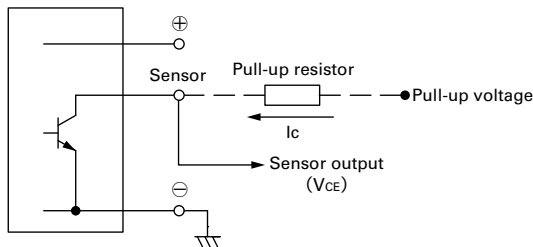

Output Waveform (Need pull-up resistor)

In case of steady running

(One revolution)

$$T_{1-4} \doteq (1/4) T_0$$

$$T_{1-4} \doteq (1/4) T_0 = 60/4N \text{ (sec)}$$

$$N = \text{Fan speed (min}^{-1}\text{)}$$

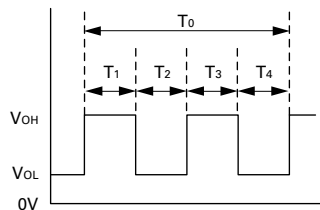

Dimensions (unit : mm)

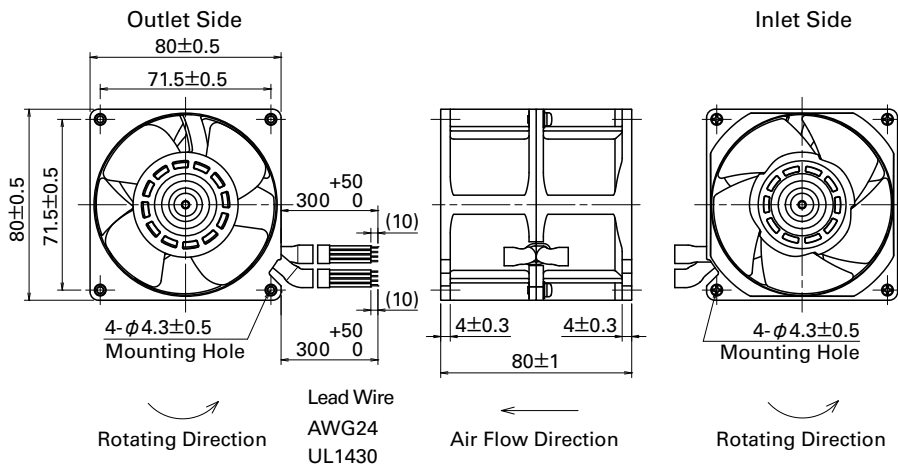

Reference Dimension of Mounting Holes and Vent Opening (unit : mm)

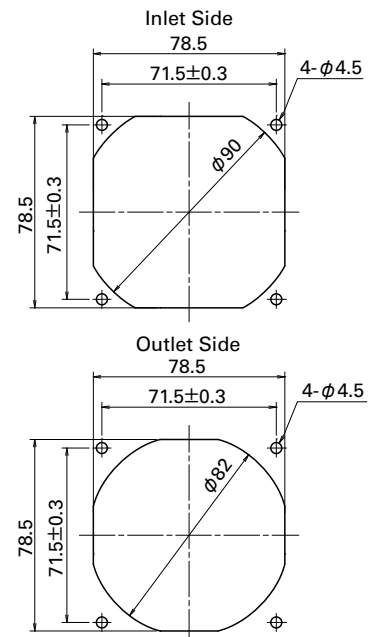

Notice

- The products shown in the catalog are subject to Japanese Export Control Law. Diversion contrary to the law of exporting country is prohibited.
- To protect against electrolytic corrosion that may occur in locations with strong electromagnetic noise, we provide fans that are unaffected by electrolytic corrosion.

SANYO DENKI CO.,LTD. 3-33-1, Minami-Otsuka, Toshima-ku, Tokyo, 170-8451, Japan TEL: +81 3 5927 1020

<http://www.sanyodenki.com>

The names of companies and/or their products specified in this catalog are the trade names, and/or trademarks and/or registered trademarks of such respective companies.

"San Ace" is a trademark of SANYO DENKI CO.,LTD.

Specifications are subject to change without notice.

CATALOG No. C1028B001 '13.9