

2012 Size

3.7GHz Band

Chip Multilayer RF Transformer

(Impedance ratio 50:100)

Balun for LO

SLT-S370KB

Shape & Size

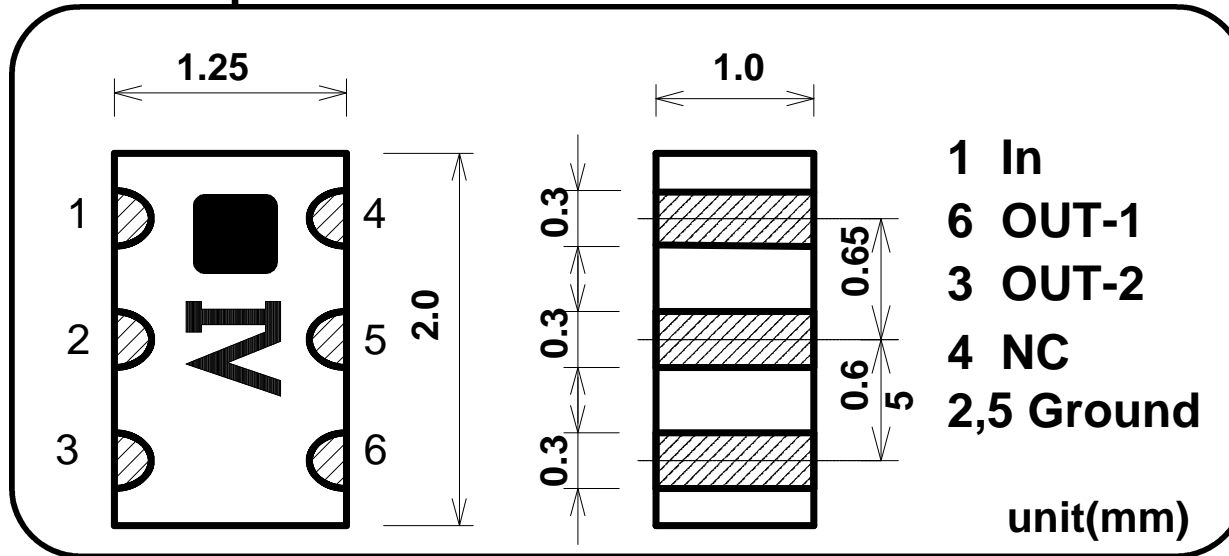

Specifications

P/N	Frequency Range(GHz)	Impedance	Insertion Loss*1	Amplitude Balance	Phase Balance	Handling Power	Temperature Range
SLT-S370KB	3.4-4.01	50:100	1.0dB Max.	1.5dB Max.	180 +/-20deg.	100mW Max.	-35 to +85 deg.C

*1:Back to Back(/piece)

"All the technical data and information contained herein are subject to change without notice."

SLT-S370KB Sample Data

Phase Balance Amp. Balance

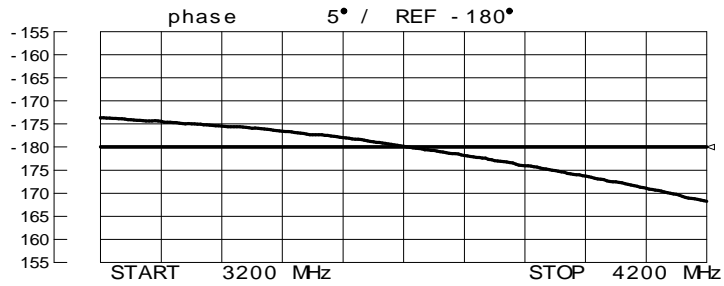
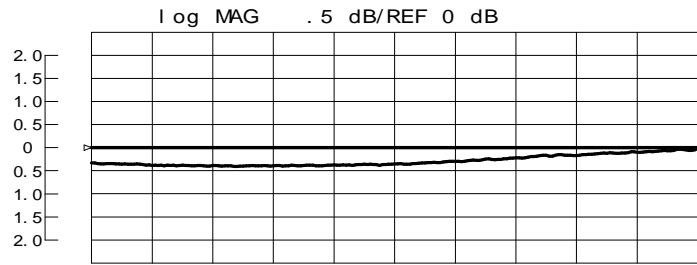
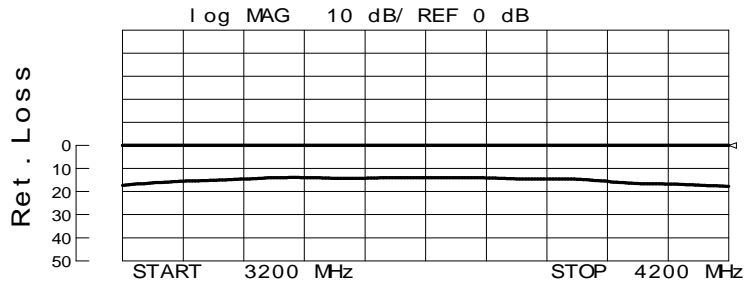

Ins. Loss

OUT-1

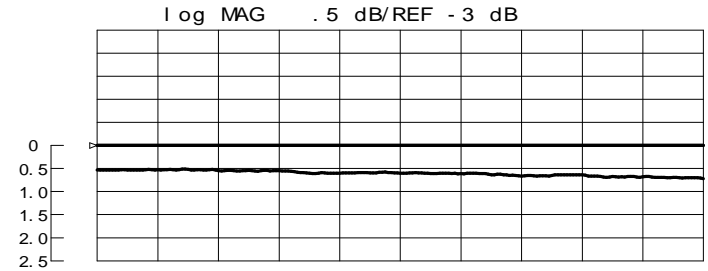

OUT-2

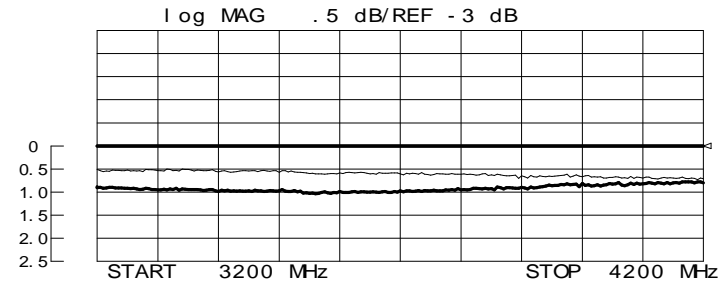

Insertion Loss (Out 1, Out 2):
measurement - splitting loss - resistor loss

Ins. Loss

Back to Back
(/ pair)

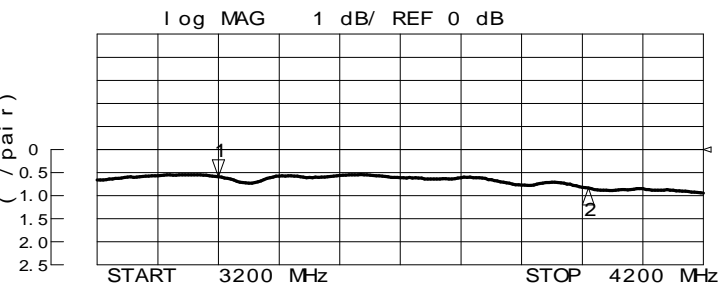

Foot Pattern

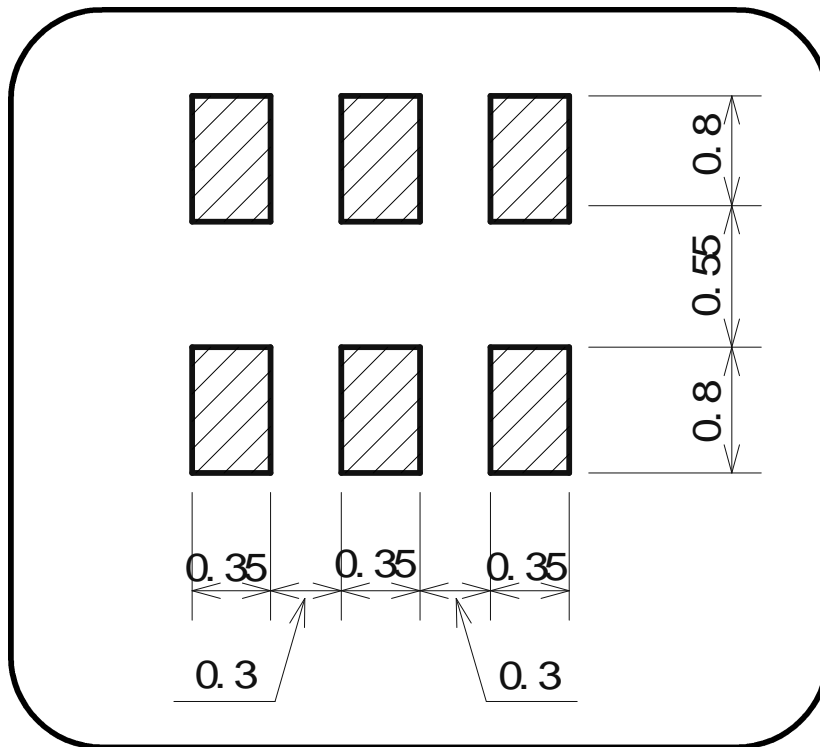

Foot Pattern Example

