

# MAZ8xxxG Series

## Silicon planar type

For stabilization of power supply

### ■ Features

- Extremely low noise voltage caused from the diode (2.4 V to 39V, 1/3 to 1/10 of our conventional MAZ3xxx series)
- Extremely good rising performance (in the low-current range)
- Easy-to-select the optimum diode because of their finely divided zener-voltage ranks
- Guaranteed reliability, equivalent to that of conventional products (Mini type package)
- Allowing to reduce the mounting area, thickness and weight substantially, compared with those of the conventional products
- Allowing both reflow and flow mode of automatic soldering
- Allowing automatic mounting by an existing chip mounter

### ■ Package

- Code  
SMini2-F3
- Pin Name  
1: Anode  
2: Cathode

### ■ Marking symbol

Refer to the list of the electrical characteristics within part numbers

### ■ Absolute Maximum Ratings $T_a = 25^\circ\text{C}$

Parameter	Symbol	Rating	Unit
Repetitive peak forward current	$I_{FRM}$	200	mA
Total power dissipation *	$P_T$	150	mW
Junction temperature	$T_j$	150	$^\circ\text{C}$
Storage temperature	$T_{stg}$	-55 to +150	$^\circ\text{C}$

Note) \*:  $P_T = 150$  mW achieved with a printed circuit board.

### ■ Common Electrical Characteristics $T_a = 25^\circ\text{C} \pm 3^\circ\text{C}$

Parameter	Symbol	Conditions	Min	Typ	Max	Unit
Forward voltage	$V_F$	$I_F = 10$ mA		0.9	1.0	V
Zener voltage *1	$V_Z$	$I_Z$ Specified value				V
Zener rise operating resistance	$R_{ZK}$	$I_Z$ Specified value	Refer to the list of the electrical characteristics within part numbers			$\Omega$
Zener operating resistance	$R_Z$	$I_Z$ Specified value				$\Omega$
Reverse current	$I_R$	$V_R$ Specified value				$\mu\text{A}$
Temperature coefficient of zener voltage *2	$S_Z$	$I_Z$ Specified value				mV/ $^\circ\text{C}$

Note) 1. Measuring methods are based on JAPANESE INDUSTRIAL STANDARD JIS C 7031 measuring methods for diodes.

2. Absolute frequency of input and output is 5 MHz.

3. The temperature must be controlled  $25^\circ\text{C}$  for  $V_Z$  measurement.

$V_Z$  value measured at other temperature must be adjusted to  $V_Z (25^\circ\text{C})$

4. \*1:  $V_Z$  guaranteed 20 ms after current flow.

\*2:  $T_j = 25^\circ\text{C}$  to  $150^\circ\text{C}$

■ Electrical Characteristics within Part Numbers  $T_a = 25^{\circ}\text{C} \pm 3^{\circ}\text{C}$ 

Part number	Zener voltage $V_Z$ (V)			Reverse current $I_R$ ( $\mu\text{A}$ )		Zener operating resistance $R_Z$ ( $\Omega$ )		Zener rise operating resistance $R_{ZK}$ ( $\Omega$ )		Temperature coefficient of zener voltage $S_Z$ (mV/ $^{\circ}\text{C}$ )		Marking symbol	
	Min	Typ	Max	$I_Z$ (mA)	Max	$V_R$ (V)	Max	$I_Z$ (mA)	Max	$I_Z$ (mA)	Typ		$I_Z$ (mA)
MAZ8024G0L	2.28	2.40	2.60	5	120	1.0	100	5			-1.6	5	2.4
MAZ8027G0L	2.50	2.70	2.90	5	120	1.0	110	5			-2.0	5	2_7 or 2^7
MAZ8027GLL	2.50	2.60	2.75										2_7
MAZ8027GHL	2.65	2.80	2.90										2^7
MAZ8030G0L	2.80	3.00	3.20	5	50	1.0	120	5		-2.1	5	3_0 or 3^0	
MAZ8030GLL	2.80	2.90	3.05									3_0	
MAZ8030GHL	2.95	3.10	3.20									3^0	
MAZ8033G0L	3.10	3.30	3.50	5	20	1.0	130	5		-2.4	5	3_3 or 3^3	
MAZ8033GLL	3.10	3.20	3.35									3_3	
MAZ8033GHL	3.25	3.40	3.50									3^3	
MAZ8036G0L	3.40	3.60	3.80	5	10	1.0	130	5		-2.4	5	3_6 or 3^6	
MAZ8036GLL	3.40	3.50	3.65									3_6	
MAZ8036GHL	3.55	3.70	3.80									3^6	
MAZ8039G0L	3.70	3.90	4.10	5	10	1.0	130	5		-2.5	5	3_9 or 3^9	
MAZ8039GLL	3.70	3.80	3.97									3_9	
MAZ8039GHL	3.87	4.00	4.10									3^9	
MAZ8043G0L	4.00	4.30	4.60	5	10	1.0	130	5		-2.5	5	4_3, 4-3 or 4^3	
MAZ8043GLL	4.03	4.10	4.26									4_3	
MAZ8043GML	4.17	4.30	4.40									4-3	
MAZ8043GHL	4.31	4.40	4.54									4^3	
MAZ8047G0L	4.40	4.70	5.00	5	2.0	1.0	80	5	800	1.0	-1.4	5	4_7, 4-7 or 4^7
MAZ8047GLL	4.45	4.60	4.69										4_7
MAZ8047GML	4.59	4.70	4.83										4-7
MAZ8047GHL	4.74	4.90	4.99										4^7
MAZ8051G0L	4.80	5.10	5.40	5	1.0	2.0	60	5	500	1.0	-0.8	5	5_1, 5-1 or 5^1
MAZ8051GLL	4.87	5.00	5.12										5_1
MAZ8051GML	5.00	5.10	5.26										5-1
MAZ8051GHL	5.14	5.30	5.40										5^1
MAZ8056G0L	5.30	5.60	6.00	5	0.5	2.5	40	5	200	0.5	1.2	5	5_6, 5-6 or 5^6
MAZ8056GLL	5.30	5.40	5.58										5_6
MAZ8056GML	5.48	5.60	5.76										5-6
MAZ8056GHL	5.66	5.80	5.95										5^6
MAZ8062G0L	5.80	6.20	6.60	5	0.2	4.0	30	5	100	0.5	2.3	5	6_2, 6-2 or 6^2
MAZ8062GLL	5.85	6.00	6.15										6_2
MAZ8062GML	6.05	6.20	6.36										6-2
MAZ8062GHL	6.24	6.40	6.56										6^2
MAZ8068G0L	6.40	6.80	7.20	5	0.1	4.0	20	5	60	0.5	3	5	6_8, 6-8 or 6^8
MAZ8068GLL	6.44	6.60	6.77										6_8
MAZ8068GML	6.64	6.80	6.98										6-8
MAZ8068GHL	6.85	7.00	7.20										6^8

■ Electrical Characteristics within Part Numbers (Continued)  $T_a = 25^{\circ}\text{C} \pm 3^{\circ}\text{C}$

Part number	Zener voltage $V_Z$ (V)			$I_Z$ (mA)	Reverse current $I_R$ ( $\mu\text{A}$ )		Zener operating resistance $R_Z$ ( $\Omega$ )		Zener rise operating resistance $R_{ZK}$ ( $\Omega$ )		Temperature coefficient of zener voltage $S_Z$ (mV/ $^{\circ}\text{C}$ )		Marking symbol
	Min	Typ	Max		Max	$V_R$ (V)	Max	$I_Z$ (mA)	Max	$I_Z$ (mA)	Typ	$I_Z$ (mA)	
MAZ8075G0L	7.00	7.50	7.90	5	0.1	5.0	20	5	60	0.5	4.0	5	7_5, 7-5 or 7^5
MAZ8075GLL	7.07	7.30	7.43										7_5
MAZ8075GML	7.29	7.50	7.67										7-5
MAZ8075GHL	7.51	7.70	7.89										7^5
MAZ8082G0L	7.70	8.20	8.70	5	0.1	5.0	20	5	60	0.5	4.6	5	8_2, 8-2 or 8^2
MAZ8082GLL	7.77	7.90	8.17										8_2
MAZ8082GML	8.03	8.20	8.43										8-2
MAZ8082GHL	8.29	8.50	8.70										8^2
MAZ8091G0L	8.50	9.10	9.60	5	0.1	6.0	20	5	60	0.5	5.5	5	9_1, 9-1 or 9^1
MAZ8091GLL	8.58	8.80	9.02										9_1
MAZ8091GML	8.87	9.10	9.33										9-1
MAZ8091GHL	9.14	9.40	9.60										9^1
MAZ8100G0L	9.40	10.00	10.60	5	0.05	7.0	30	5	60	0.5	6.4	5	10_, 10- or 10^
MAZ8100GLL	9.44	9.70	9.92										10_
MAZ8100GML	9.75	10.00	10.25										10-
MAZ8100GHL	10.07	10.30	10.59										10^
MAZ8110G0L	10.40	11.00	11.60	5	0.05	8.0	30	5	60	0.5	7.4	5	11_, 11- or 11^
MAZ8110GLL	10.40	10.70	10.94										11_
MAZ8110GML	10.73	11.00	11.28										11-
MAZ8110GHL	11.05	11.30	11.60										11^
MAZ8120G0L	11.40	12.00	12.70	5	0.05	9.0	30	5	80	0.5	8.4	5	12_, 12- or 12^
MAZ8120GLL	11.40	11.70	11.96										12_
MAZ8120GML	11.73	12.00	12.33										12-
MAZ8120GHL	12.06	12.30	12.68										12^
MAZ8130G0L	12.40	13.00	14.10	5	0.05	10.0	35	5	80	0.5	9.4	5	13_, 13- or 13^
MAZ8130GLL	12.40	12.70	12.99										13_
MAZ8130GML	12.73	13.00	13.40										13-
MAZ8130GHL	13.25	13.70	14.08										13^
MAZ8140GML	13.65	14.00	14.35	5	0.05	10.0	40	5	80	0.5	10.0	5	14-
MAZ8150G0L	13.90	15.00	15.60	5	0.05	11.0	40	5	80	0.5	11.4	5	15_, 15- or 15^
MAZ8150GLL	13.90	14.30	14.76										15_
MAZ8150GML	14.60	15.00	15.35										15-
MAZ8150GHL	14.95	15.30	15.60										15^
MAZ8160G0L	15.30	16.00	17.10	5	0.05	12.0	50	5	80	0.5	12.4	5	16_, 16- or 16^
MAZ8160GLL	15.30	15.70	16.09										16_
MAZ8160GML	15.70	16.00	16.50										16-
MAZ8160GHL	16.26	16.70	17.10										16^
MAZ8180G0L	16.90	18.00	19.10	5	0.05	13.0	60	5	80	0.5	14.4	5	18_, 18- or 18^
MAZ8180GLL	16.90	17.30	17.76										18_
MAZ8180GML	17.55	18.00	18.45										18-
MAZ8180GHL	18.20	18.70	19.10										18^

■ Electrical Characteristics within Part Numbers (Continued)  $T_a = 25^\circ\text{C} \pm 3^\circ\text{C}$ 

Part number	Zener voltage $V_Z$ (V)			$I_Z$ (mA)	Reverse current $I_R$ ( $\mu\text{A}$ )		Zener operating resistance $R_Z$ ( $\Omega$ )		Zener rise operating resistance $R_{ZK}$ ( $\Omega$ )		Temperature coefficient of zener voltage $S_Z$ (mV/ $^\circ\text{C}$ )		Marking symbol
	Min	Typ	Max		Max	$V_R$ (V)	Max	$I_Z$ (mA)	Max	$I_Z$ (mA)	Typ	$I_Z$ (mA)	
MAZ8200G0L	18.80	20.00	21.20	5	0.05	15.0	80	5	100	0.5	16.4	5	20_, 20- or 20^
MAZ8200GLL	18.85	19.30	19.81										20_
MAZ8200GML	19.50	20.00	20.50										20-
MAZ8200GHL	20.15	20.70	21.19										20^
MAZ8220G0L	20.80	22.00	23.30	5	0.05	17.0	80	5	100	0.5	18.4	5	22_, 22- or 22^
MAZ8220GLL	20.80	21.30	21.86										22_
MAZ8220GML	21.45	22.00	22.55										22-
MAZ8220GHL	22.10	22.70	23.24										22^
MAZ8240G0L	22.80	24.00	25.60	5	0.05	19.0	100	5	120	0.5	20.4	5	24_, 24- or 24^
MAZ8240GLL	22.80	23.30	23.97										24_
MAZ8240GML	23.50	24.00	24.70										24-
MAZ8240GHL	24.35	25.00	25.60										24^
MAZ8270G0L	25.10	27.00	28.90	2	0.05	21.0	120	2	120	0.5	23.4	2	27_, 27- or 27^
MAZ8270GLL	25.30	26.00	26.70										27_
MAZ8270GML	26.30	27.00	27.70										27-
MAZ8270GHL	27.30	28.00	28.70										27^
MAZ8300G0L	28.00	30.00	32.00	2	0.05	23.0	160	2	160	0.5	26.6	2	30_, 30- or 30^
MAZ8300GLL	28.30	29.00	29.70										30_
MAZ8300GML	29.30	30.00	30.80										30-
MAZ8300GHL	30.20	31.00	31.80										30^
MAZ8330G0L	31.00	33.00	35.00	2	0.05	25.0	200	2	200	0.5	29.7	2	33_, 33- or 33^
MAZ8330GLL	31.20	32.00	32.80										33_
MAZ8330GML	32.20	33.00	33.80										33-
MAZ8330GHL	33.20	34.00	34.90										33^
MAZ8360G0L	34.00	36.00	38.00	2	0.05	27.0	250	2	250	0.5	33.0	2	36_, 36- or 36^
MAZ8360GLL	34.10	35.00	35.90										36_
MAZ8360GML	35.10	36.00	36.90										36-
MAZ8360GHL	36.10	37.00	37.90										36^
MAZ8390G0L	37.00	39.00	41.00	2	0.05	30.0	300	2	300	0.5	35.6	2	39_, 39- or 39^
MAZ8390GLL	37.10	38.00	39.00										39_
MAZ8390GML	38.00	39.00	40.00										39-
MAZ8390GHL	39.00	40.00	41.00										39^

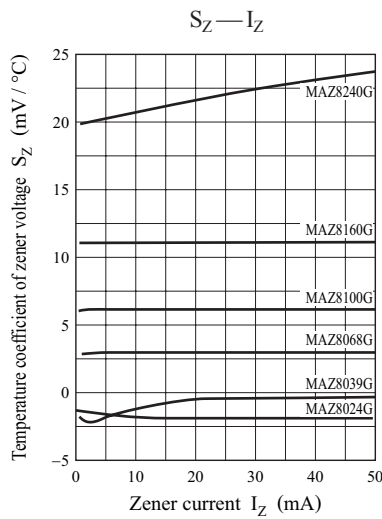
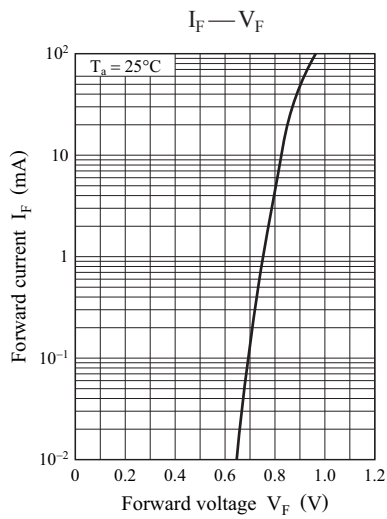
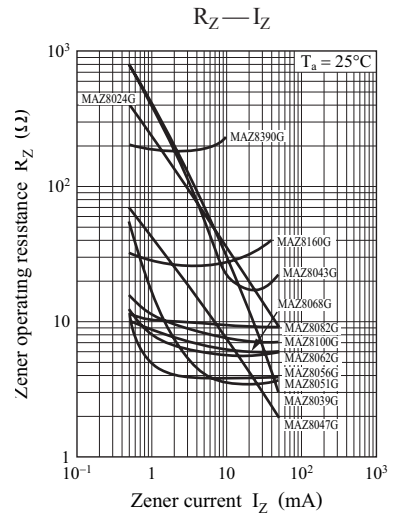
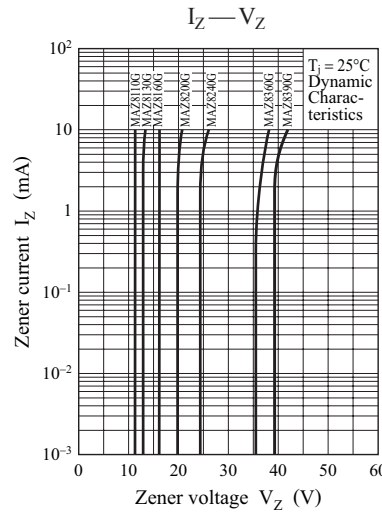
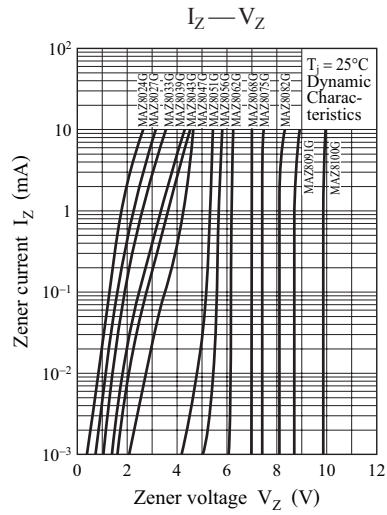
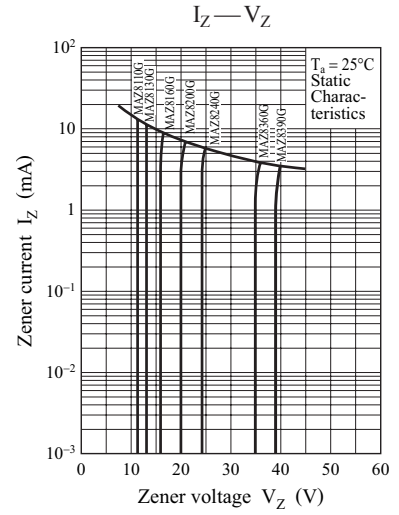
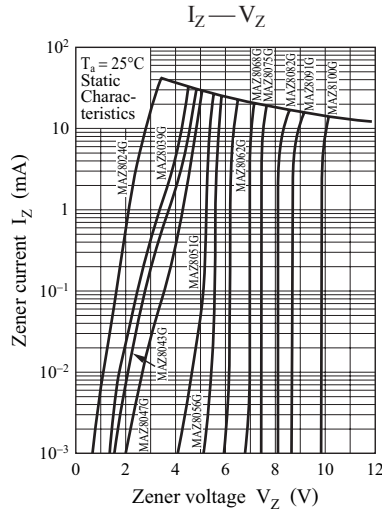
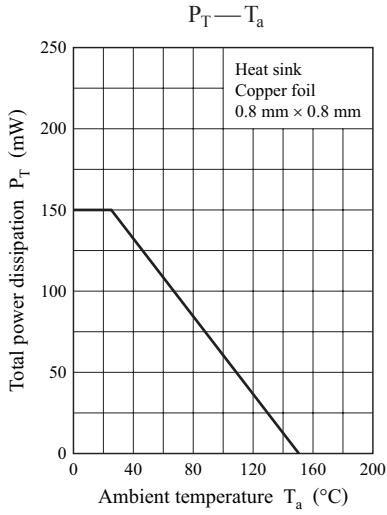

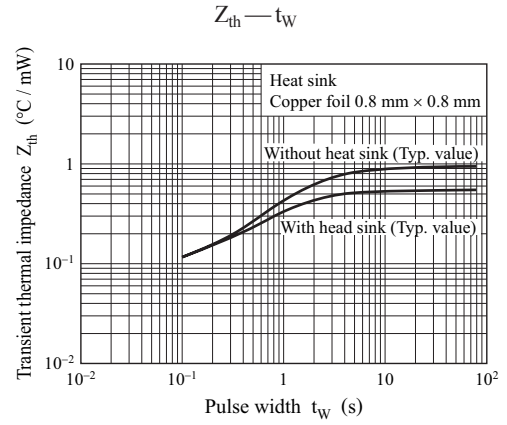
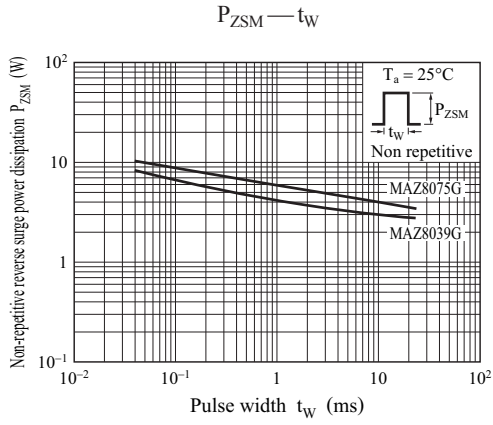

SMini2-F3

Unit: mm

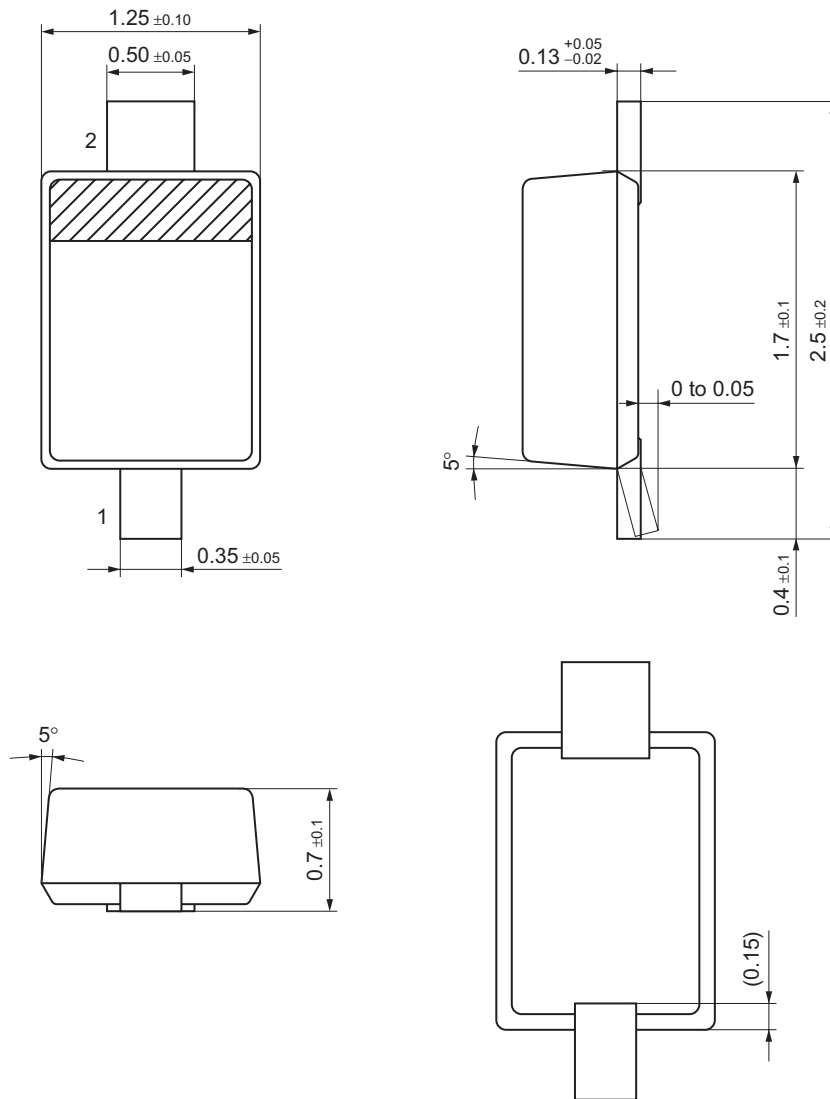

## Request for your special attention and precautions in using the technical information and semiconductors described in this book

- (1) If any of the products or technical information described in this book is to be exported or provided to non-residents, the laws and regulations of the exporting country, especially, those with regard to security export control, must be observed.
- (2) The technical information described in this book is intended only to show the main characteristics and application circuit examples of the products. No license is granted in and to any intellectual property right or other right owned by Panasonic Corporation or any other company. Therefore, no responsibility is assumed by our company as to the infringement upon any such right owned by any other company which may arise as a result of the use of technical information described in this book.
- (3) The products described in this book are intended to be used for standard applications or general electronic equipment (such as office equipment, communications equipment, measuring instruments and household appliances).  
Consult our sales staff in advance for information on the following applications:
  - Special applications (such as for airplanes, aerospace, automobiles, traffic control equipment, combustion equipment, life support systems and safety devices) in which exceptional quality and reliability are required, or if the failure or malfunction of the products may directly jeopardize life or harm the human body.
  - Any applications other than the standard applications intended.
- (4) The products and product specifications described in this book are subject to change without notice for modification and/or improvement. At the final stage of your design, purchasing, or use of the products, therefore, ask for the most up-to-date Product Standards in advance to make sure that the latest specifications satisfy your requirements.
- (5) When designing your equipment, comply with the range of absolute maximum rating and the guaranteed operating conditions (operating power supply voltage and operating environment etc.). Especially, please be careful not to exceed the range of absolute maximum rating on the transient state, such as power-on, power-off and mode-switching. Otherwise, we will not be liable for any defect which may arise later in your equipment.
  - Even when the products are used within the guaranteed values, take into the consideration of incidence of break down and failure mode, possible to occur to semiconductor products. Measures on the systems such as redundant design, arresting the spread of fire or preventing glitch are recommended in order to prevent physical injury, fire, social damages, for example, by using the products.
- (6) Comply with the instructions for use in order to prevent breakdown and characteristics change due to external factors (ESD, EOS, thermal stress and mechanical stress) at the time of handling, mounting or at customer's process. When using products for which damp-proof packing is required, satisfy the conditions, such as shelf life and the elapsed time since first opening the packages.
- (7) This book may be not reprinted or reproduced whether wholly or partially, without the prior written permission of our company.