

# SK 30 DTA



**SEMITOP<sup>®</sup> 3**

## 3-phase bridge rectifier+ series thyristor

### SK 30 DTA

#### Target Data

#### Features

- Compact design
- One screw mounting
- Heat transfer and isolation through direct copper bonded aluminium oxide ceramic (DBC)
- Glass passivated thyristor chips
- Reverse voltage up to 1600 V
- High surge currents

#### Typical Applications\*

- Soft starters
- Light control
- Temperature control

$V_{RSM}$ V	$V_{RRM}, V_{DRM}$ V	$I_D = 25$ A ( $T_s = 80$ °C)
900	800	SK 30 DTA 08
1300	1200	SK 30 DTA 12
1700	1600	SK 30 DTA 16

Characteristics		$T_s = 25$ °C unless otherwise specified	
Symbol	Conditions	Values	Units
$I_D$	$T_s = 80$ °C; Ind. load	25	A
$I_{TAV}$	sin. 180°; $T_s = 25$ (80) °C per thyristor	31 (19)	A
$I_{FAV}$	sin. 180°; $T_s = 25$ (80) °C per diode	37 (25)	A
$I_{TSM}/I_{FSM}$	$T_{vj} = 25$ (125) °C; 10 ms	1000 (900)	A
$I^2t$	$T_{vj} = 25$ (125) °C; 8,3 ... 10 ms	5000 (4000)	A <sup>2</sup> s
$T_{stg}$		-40,...+125	°C
$T_{solder}$	terminals, 10 s	260	°C
<b>Thyristor</b>			
$(dv/dt)_{cr}$	$T_{vj} = 125$ °C	1000	V/μs
$(di/dt)_{cr}$	$T_{vj} = 125$ °C; $f = 50 \dots 60$ Hz	50	A/μs
$t_q$	$T_{vj} = 125$ °C; typ.	80	μs
$I_H$	$T_{vj} = 25$ °C; typ. / max.	100 / 200	mA
$I_L$	$T_{vj} = 25$ °C; $R_G = 33$ Ω; typ. / max.	200 / 400	mA
$V_T$	$T_{vj} = 25$ °C; ( $I_T = 120$ A); max.	1,8	V
$V_{T(TO)}$	$T_{vj} = 125$ °C	max. 1	V
$r_T$	$T_{vj} = 125$ °C	max. 6	mΩ
$I_{DD}; I_{RD}$	$T_{vj} = 125$ °C; $V_{DD} = V_{DRM}; V_{RD} = V_{RRM}$	max. 8	mA
$R_{th(j-s)}$	Cont. per thyristor	0,8	K/W
$T_{vj}$		- 40 ... + 125	°C
$V_{GT}$	$T_{vj} = 25$ °C; d.c.	2	V
$I_{GT}$	$T_{vj} = 25$ °C; d.c.	100	mA
$V_{GD}$	$T_{vj} = 125$ °C; d.c.	0,25	V
$I_{GD}$	$T_{vj} = 125$ °C; d.c.	5	mA
<b>Diode</b>			
$V_F$	$T_{vj} = 25$ °C; ( $I_F = 25$ A); max.	1,25	V
$V_{(TO)}$	$T_{vj} = 150$ °C	0,8	V
$r_T$	$T_{vj} = 150$ °C	4	mΩ
$I_{RD}$	$T_{vj} = 150$ °C; $V_{RD} = V_{RRM}$	4	mA
$R_{th(j-s)}$	per diode	1,7	K/W
$T_{vj}$		-40...+150	°C
<b>Mechanical data</b>			
$V_{isol}$	a. c. 50 Hz; r.m.s.; 1 s / 1 min	3000 (2500)	V
$M_1$	mounting torque	2,5	Nm
w		30	g
Case	SEMITOP <sup>®</sup> 3	T 45	

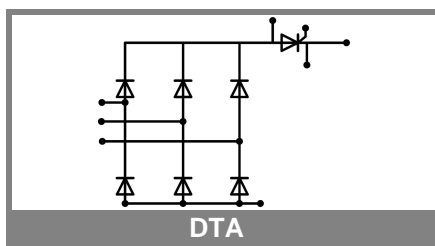

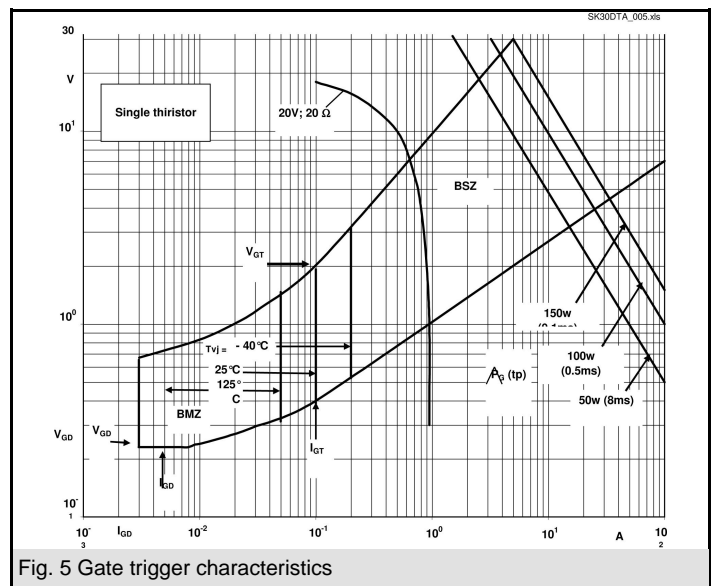
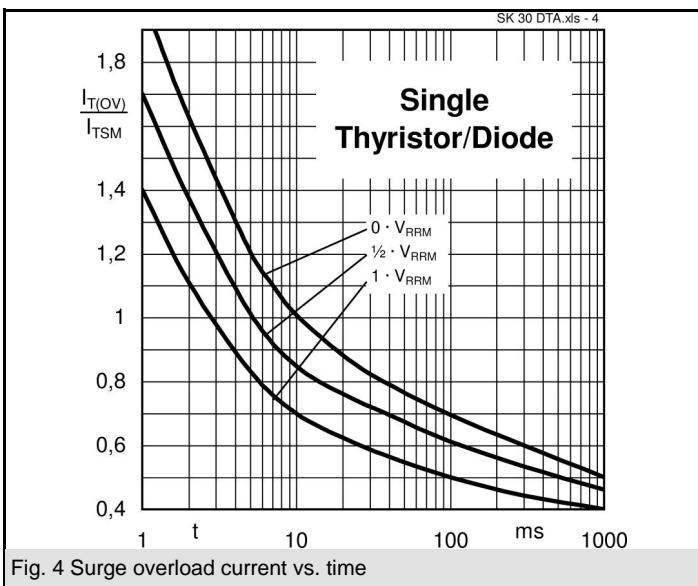
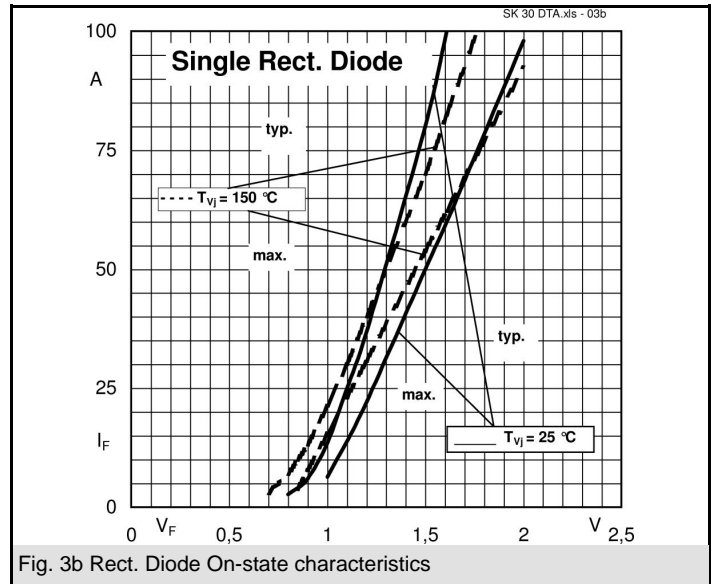
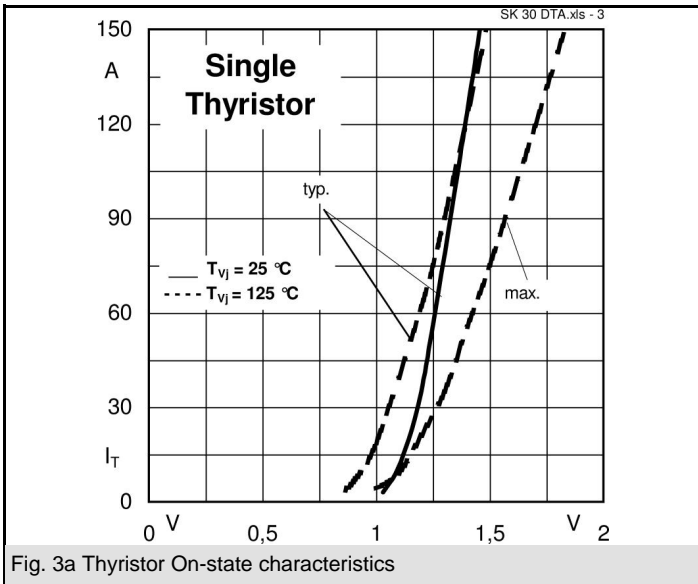
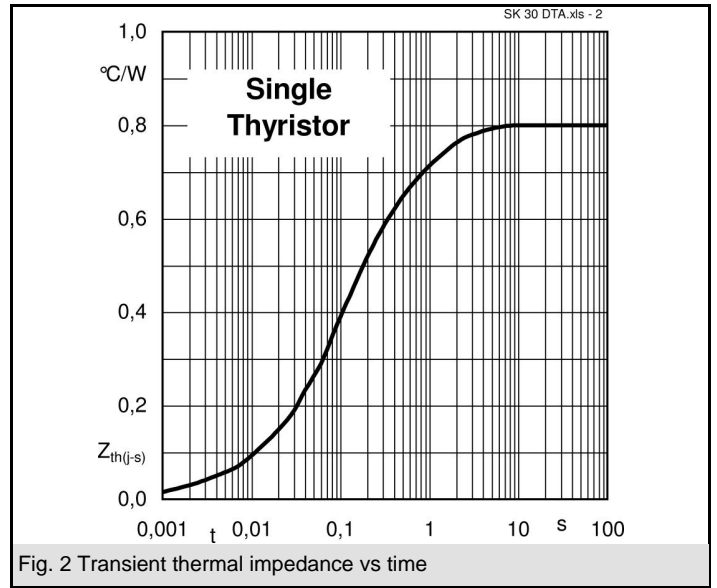
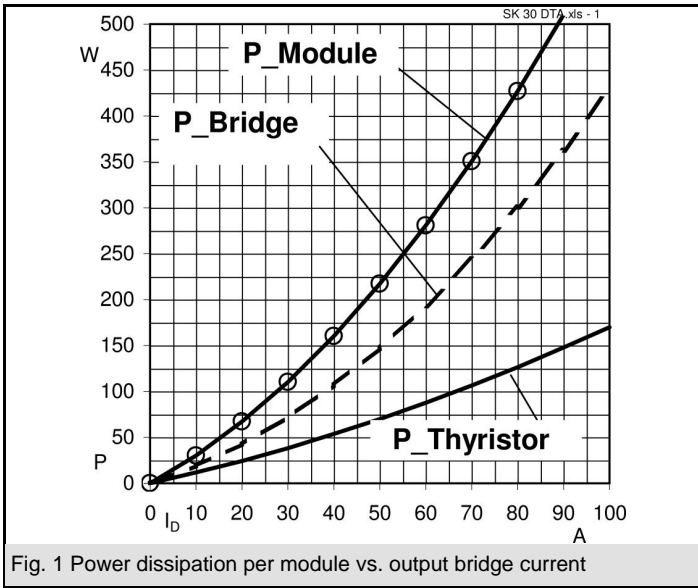

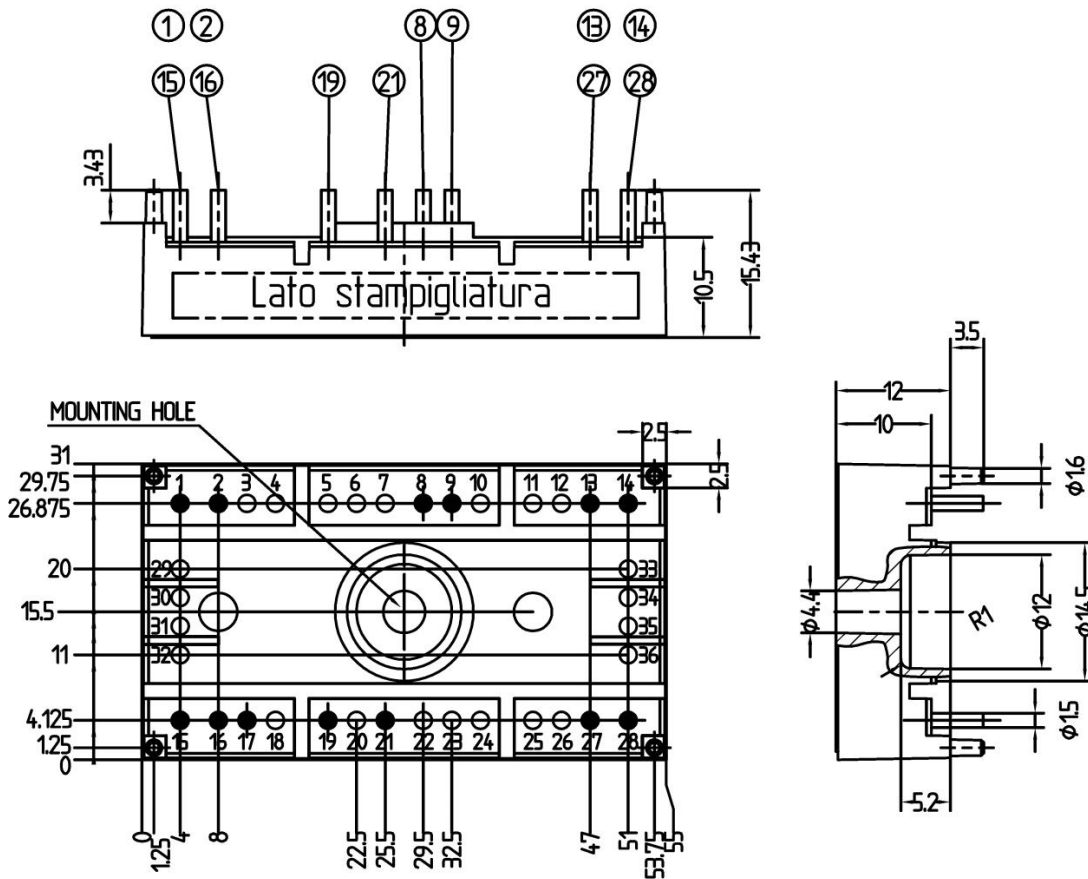

SUGGESTED HOLEDIAMETER FOR THE SOLDER PINS AND THE MOUNTING PINS IN THE PCB: 2 mm

Case T45 (Suggested hole diameter, in the PCB, for solder pins and plastic mounting pins: 2mm)

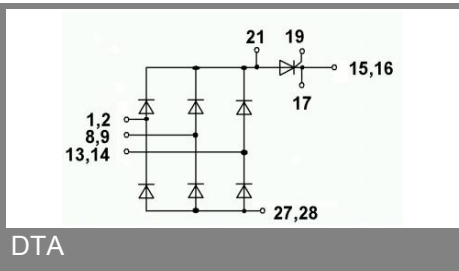

This is an electrostatic discharge sensitive device (ESDS), international standard IEC 60747-1, Chapter IX.

\* The specifications of our components may not be considered as an assurance of component characteristics. Components have to be tested for the respective application. Adjustments may be necessary. The use of SEMIKRON products in life support appliances and systems is subject to prior specification and written approval by SEMIKRON. We therefore strongly recommend prior consultation of our personal.