

**HIGH EFFICIENCY POWER SCHOTTKY RECTIFIER****MBR2045C****General Description**

High efficiency dual Schottky rectifier suited for switch mode power supplies and other power converters. This device is intended for use in medium voltage operation, and particularly, in high frequency circuits where low switching losses and low noise are required.

MBR2045C is available in TO-220-3, TO-220-3 (2) and TO-220F-3 packages.

Features

- Low Forward Voltage: 0.57V @ 125°C
- Low Power Loss/High Efficiency
- 150°C Operating Junction Temperature
- 20A Total (10A Each Diode Leg)
- Guard-ring for Stress Protection
- High Surge Capacity
- Pb-free Package

Applications

- Power Supply Output Rectification
- Power Management
- Instrumentation

Main Product Characteristics

$I_{F(AV)}$	2×10A
V_{RRM}	45V
T_J	150°C
$V_F(max)$	0.57V

Mechanical Characteristics

- Case: Epoxy, Molded
- Epoxy Meets UL 94V-0 @ 0.125in.
- Weight (Approximately):
1.9Grams (TO-220-3, TO-220-3 (2) and TO-220F-3)
- Finish: All External Surfaces Corrosion Resistant and Terminal
- Leads are Readily Solderable
- Lead Temperature for Soldering Purposes:
260°C Maximum for 10 Seconds

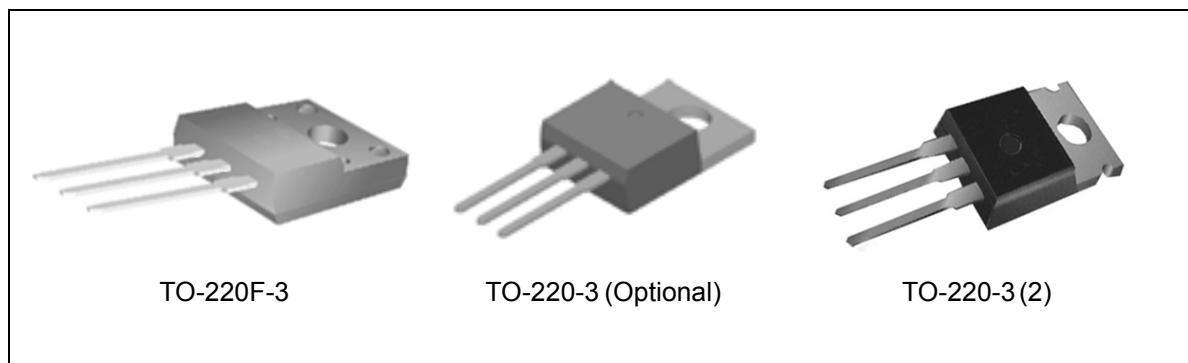

Figure 1. Package Types of MBR2045C

Pin Configuration

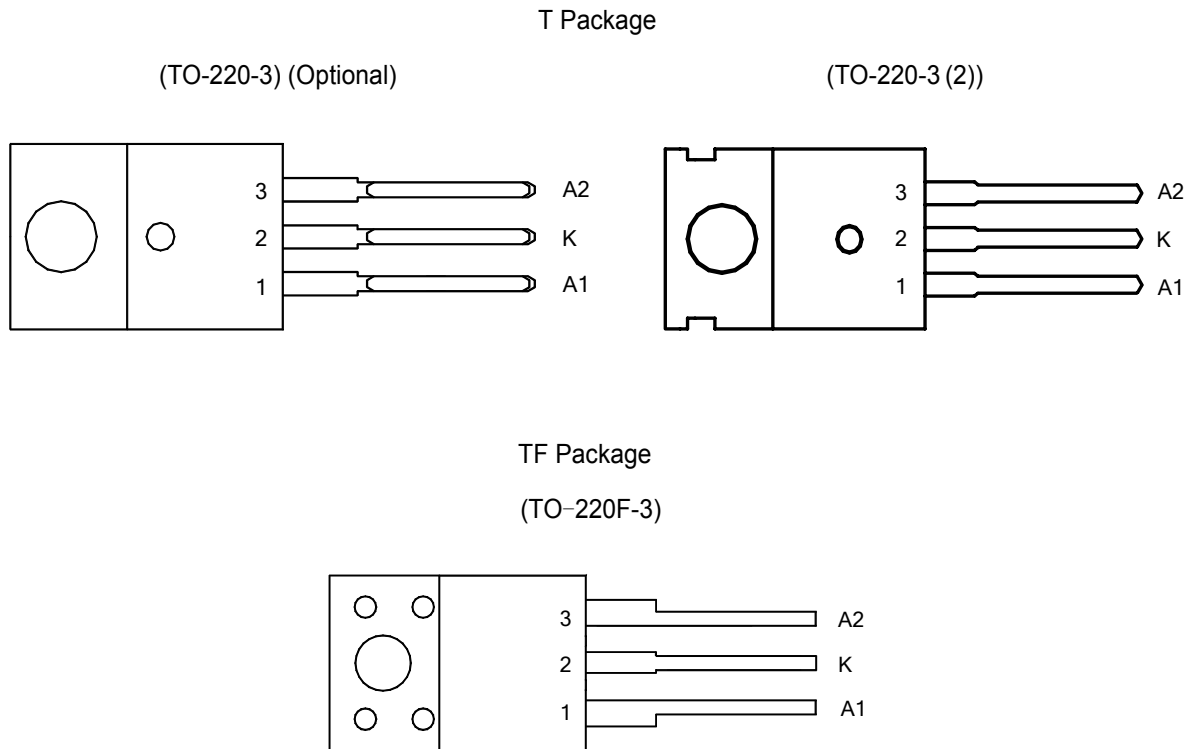

Figure 2. Pin Configuration of MBR2045C (Top View)

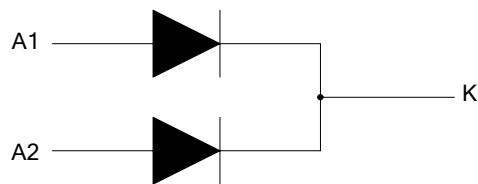
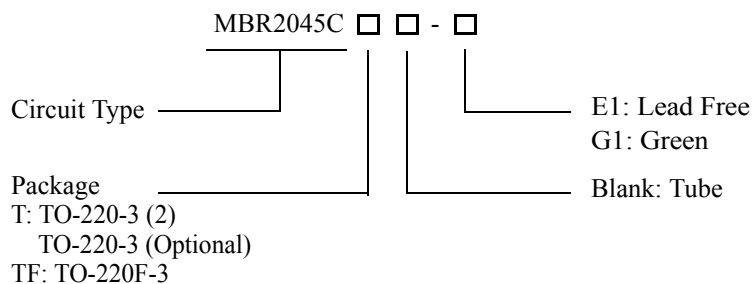

Figure 3. Internal Structure of MBR2045C

**HIGH EFFICIENCY POWER SCHOTTKY RECTIFIER****MBR2045C****Ordering Information**

Package	Part Number		Marking ID		Packing Type
	Lead Free	Green	Lead Free	Green	
TO-220-3 (2)	MBR2045CT-E1	MBR2045CT-G1	MBR2045CT-E1	MBR2045CT-G1	Tube
TO-220F-3	MBR2045CTF-E1	MBR2045CTF-G1	MBR2045CTF-E1	MBR2045CTF-G1	Tube

BCD Semiconductor's Pb-free products, as designated with "E1" suffix in the part number, are RoHS compliant. Products with "G1" suffix are available in green packages.

**HIGH EFFICIENCY POWER SCHOTTKY RECTIFIER****MBR2045C****Absolute Maximum Ratings (Each Diode Leg) (Note 1)**

Parameter	Symbol	Value	Unit
Peak Repetitive Reverse Voltage Working Peak Reverse Voltage DC Blocking Voltage	V_{RRM} V_{RWM} V_R	45	V
Average Rectified Forward Current (Rated V_R) $T_C=139^\circ\text{C}$	$I_{F(AV)}$	10	A
Peak Repetitive Forward Current (Rated V_R , Square Wave, 20kHz) $T_C=137^\circ\text{C}$	I_{FRM}	20	A
Non Repetitive Peak Surge Current (Surge Applied at Rated Load Conditions Half Wave, Single Phase, 60Hz)	I_{FSM}	150	A
Peak Repetitive Reverse Surge Current (2.0 μs , 1.0kHz)	I_{RRM}	1.0	A
Operating Junction Temperature (Note 2)	T_J	150	$^\circ\text{C}$
Storage Temperature Range	T_{STG}	-65 to 150	$^\circ\text{C}$
Voltage Rate of Change (Rated V_R)	dv/dt	10000	V/ μs
ESD (Machine Model=C)		>400	V
ESD (Human Body Model=3B)		>8000	V

Note 1: Stresses greater than those listed under "Absolute Maximum Ratings" may cause permanent damage to the device. These are stress ratings only, and functional operation of the device at these or any other conditions beyond those indicated under "Recommended Operating Conditions" is not implied. Exposure to "Absolute Maximum Ratings" for extended periods may affect device reliability.

Note 2: The heat generated must be less than the thermal conductivity from Junction to Ambient: $dP_D/dT_J < 1/\theta_{JA}$.

Thermal Characteristics

Parameter	Symbol	Condition	Value	Unit	
Maximum Thermal Resistance	θ_{JC}	Junction to Case	TO-220-3/ TO-220-3 (2)	2.2	$^\circ\text{C}/\text{W}$
			TO-220F-3	4.5	
	θ_{JA}	Junction to Ambient	TO-220-3/ TO-220-3 (2)	60	

**HIGH EFFICIENCY POWER SCHOTTKY RECTIFIER****MBR2045C****Electrical Characteristics (Each Diode Leg)**

Parameter	Condition	Symbol	Typ	Max	Unit
Maximum Instantaneous Forward Voltage Drop (Note 3)	$I_F=10A, T_C=25^\circ C$	V_F	0.59	0.65	V
	$I_F=10A, T_C=125^\circ C$		0.50	0.57	
	$I_F=20A, T_C=25^\circ C$		0.71	0.84	
	$I_F=20A, T_C=125^\circ C$		0.67	0.72	
Maximum Instantaneous Reverse Current (Note 3)	Rated DC Voltage, $T_C=125^\circ C$	I_R	5	15	mA
	Rated DC Voltage, $T_C=25^\circ C$		0.01	0.1	

Note 3: Pulse Test: Pulse Width=300 μ s, Duty Cycle \leq 2.0%.



Typical Performance Characteristics

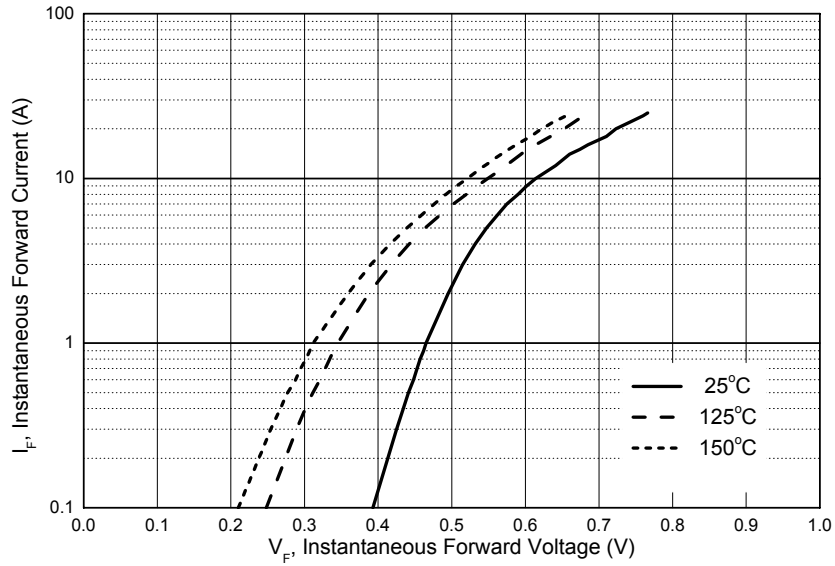

Figure 4. Typical Forward Voltage

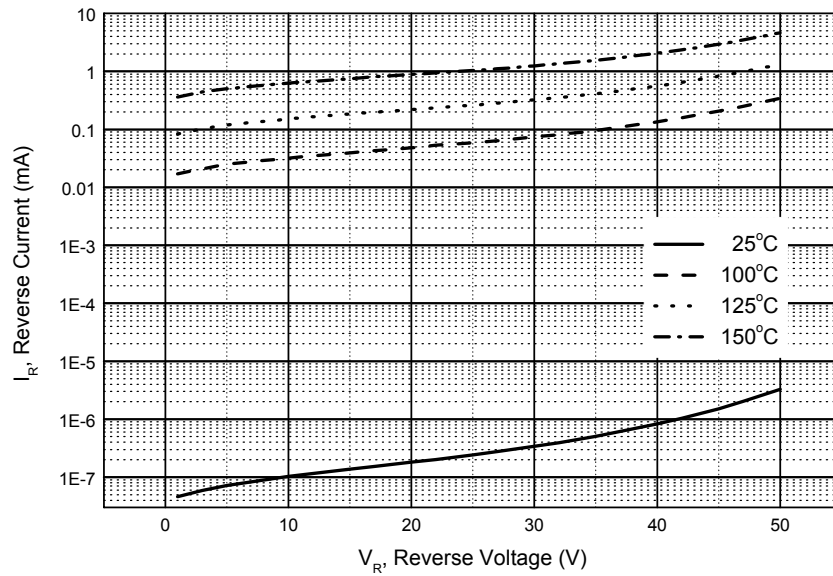

Figure 5. Typical Reverse Current



Typical Performance Characteristics (Continued)

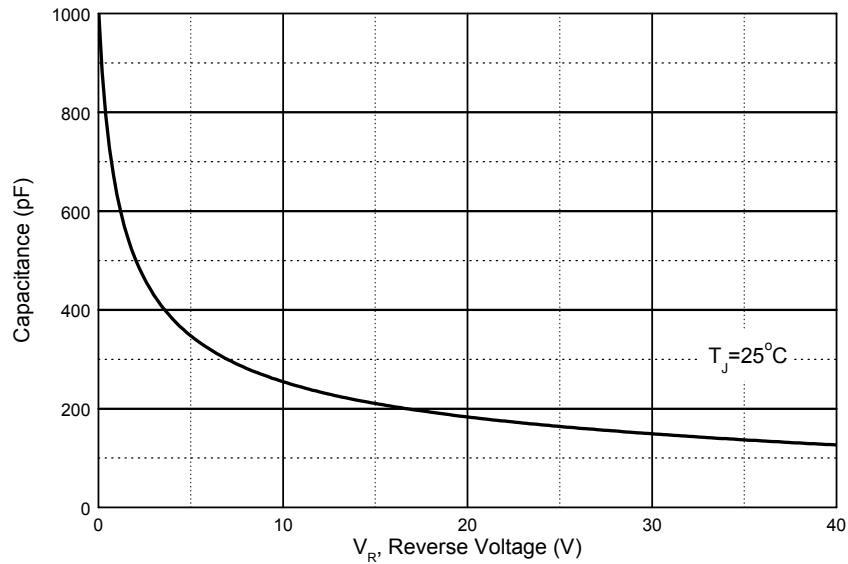

Figure 6. Capacitance vs. V_R , Reverse Voltage

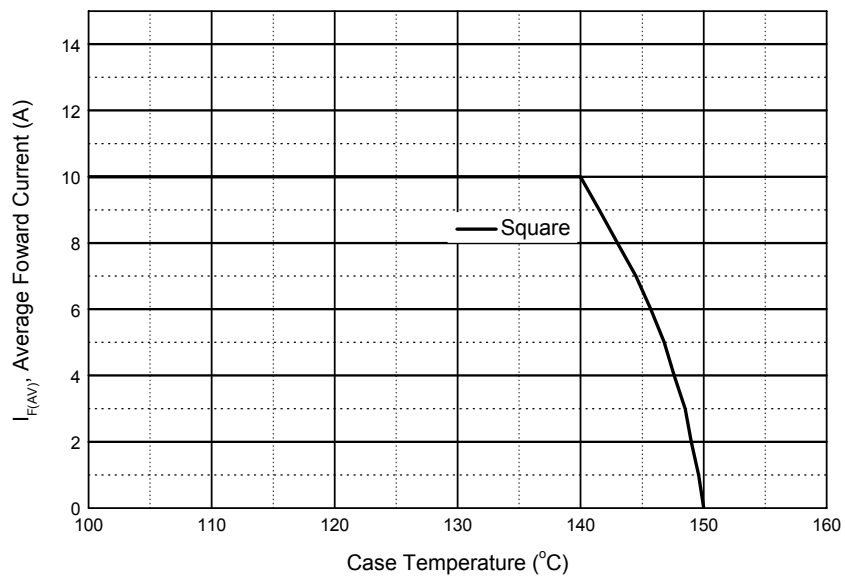

Figure 7. Average Forward Current vs. Case Temperature (Square, Each Diode)



HIGH EFFICIENCY POWER SCHOTTKY RECTIFIER

MBR2045C

Mechanical Dimensions

TO-220-3
(Optional)

Unit: mm(inch)

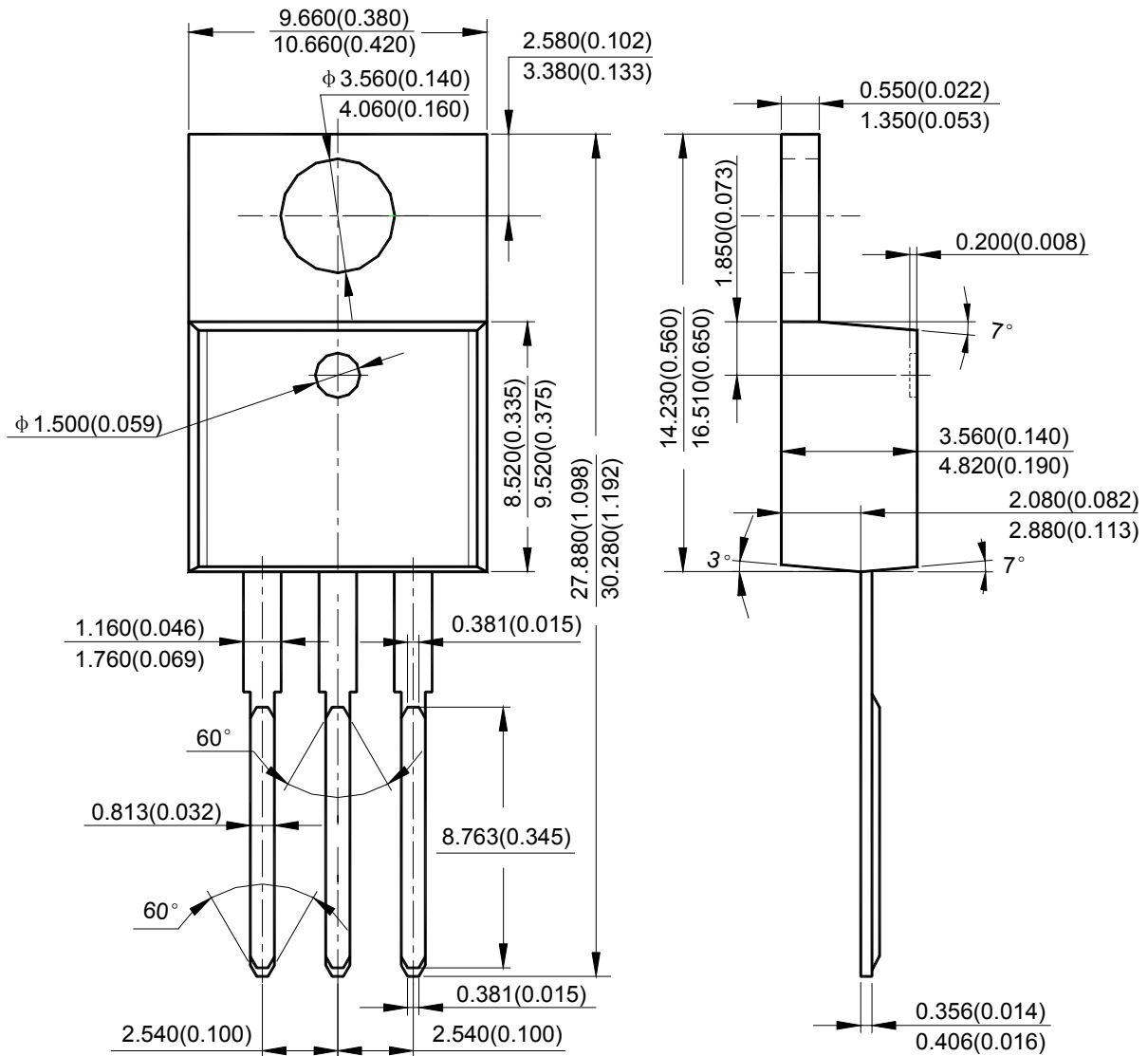



HIGH EFFICIENCY POWER SCHOTTKY RECTIFIER

MBR2045C

Mechanical Dimensions (Continued)

TO-220-3 (2)

Unit: mm(inch)

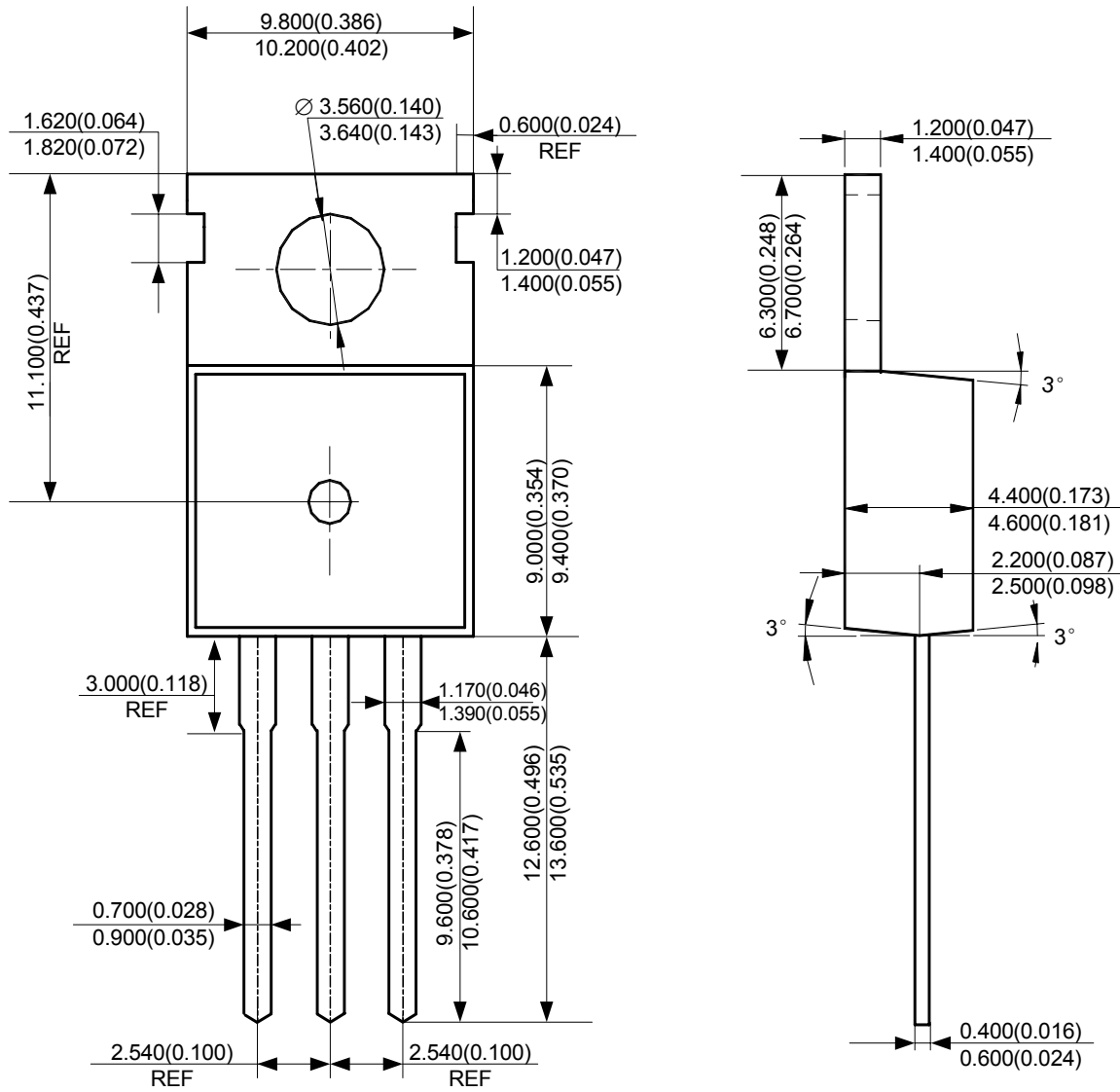



HIGH EFFICIENCY POWER SCHOTTKY RECTIFIER

MBR2045C

Mechanical Dimensions (Continued)

TO-220F-3

Unit: mm(inch)

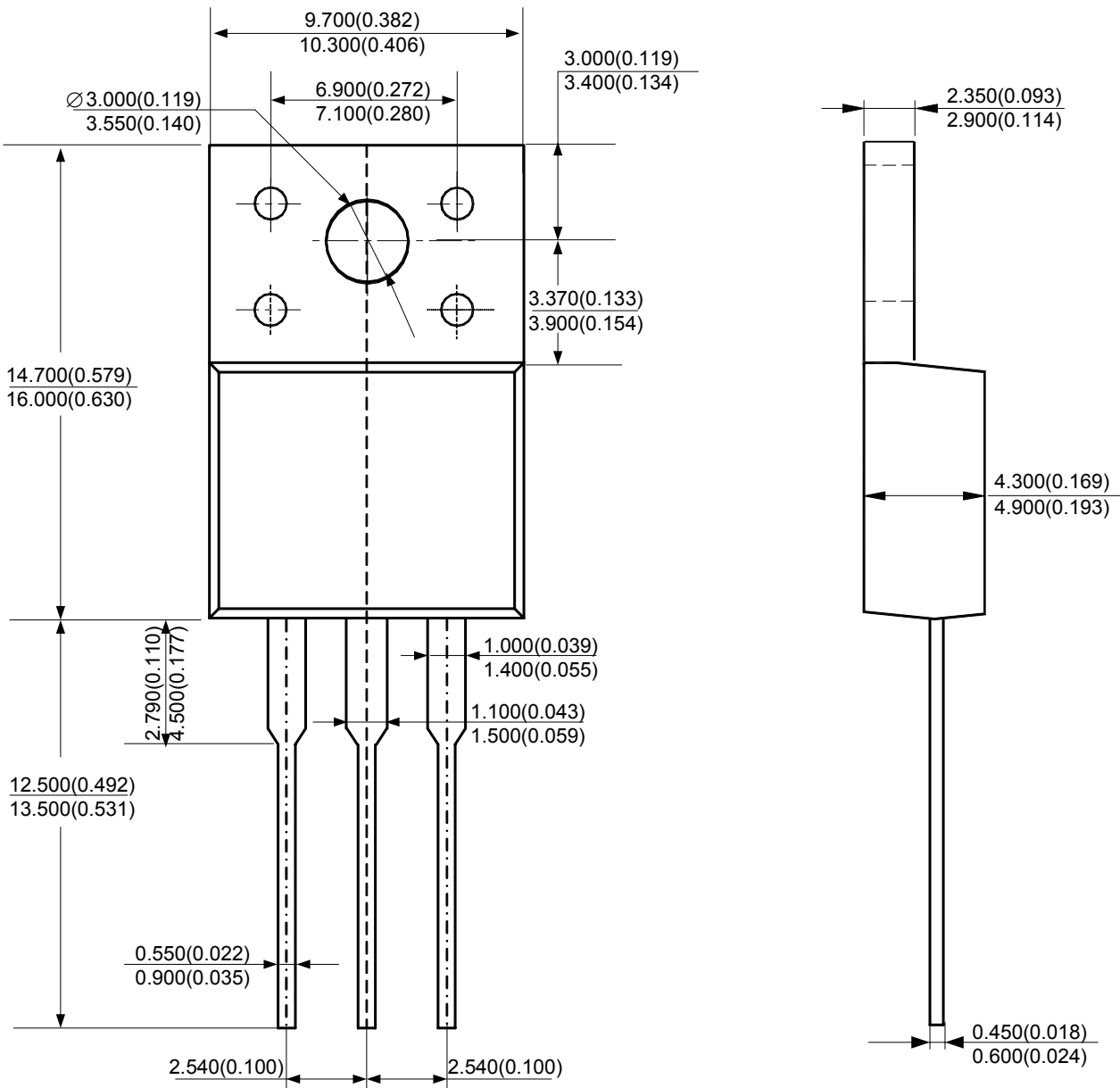



BCD Semiconductor Manufacturing Limited

<http://www.bcdsemi.com>

IMPORTANT NOTICE

BCD Semiconductor Manufacturing Limited reserves the right to make changes without further notice to any products or specifications herein. BCD Semiconductor Manufacturing Limited does not assume any responsibility for use of any its products for any particular purpose, nor does BCD Semiconductor Manufacturing Limited assume any liability arising out of the application or use of any its products or circuits. BCD Semiconductor Manufacturing Limited does not convey any license under its patent rights or other rights nor the rights of others.

MAIN SITE

- Headquarters

BCD Semiconductor Manufacturing Limited

No. 1600, Zi Xing Road, Shanghai Zizhu Science-based Industrial Park, 200241, China
Tel: +86-21-24162266, Fax: +86-21-24162277

- Wafer Fab

Shanghai SIM-BCD Semiconductor Manufacturing Co., Ltd.

800 Yi Shan Road, Shanghai 200233, China
Tel: +86-21-6485 1491, Fax: +86-21-5450 0008

REGIONAL SALES OFFICE

Shenzhen Office

Shanghai SIM-BCD Semiconductor Manufacturing Co., Ltd., Shenzhen Office

Unit A Room 1203, Skyworth Bldg., Gaoxin Ave. 1.S., Nanshan District, Shenzhen, China
Tel: +86-755-8826 7951
Fax: +86-755-8826 7865

Taiwan Office

BCD Semiconductor (Taiwan) Company Limited

4F, 298-1, Rui Guang Road, Nei-Hu District, Taipei, Taiwan
Tel: +886-2-2656 2808
Fax: +886-2-2656 2806

USA Office

BCD Semiconductor Corp.

30920 Huntwood Ave. Hayward, CA 94544, USA
Tel : +1-510-324-2988
Fax: +1-510-324-2788