

General Description

SRFET™ The AO4706 uses advanced trench technology with a monolithically integrated Schottky diode to provide excellent $R_{DS(ON)}$, and low gate charge. This device is suitable for use as a low side FET in SMPS, load switching and general purpose applications.

Product Summary

$V_{DS} (V) = 30V$
 $I_D = 16.5A (V_{GS} = 10V)$
 $R_{DS(ON)} < 6.8m\Omega (V_{GS} = 10V)$
 $R_{DS(ON)} < 8.2m\Omega (V_{GS} = 4.5V)$

100% UIS Tested
 100% Rg Tested



SOIC-8

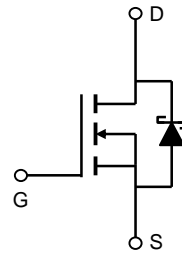
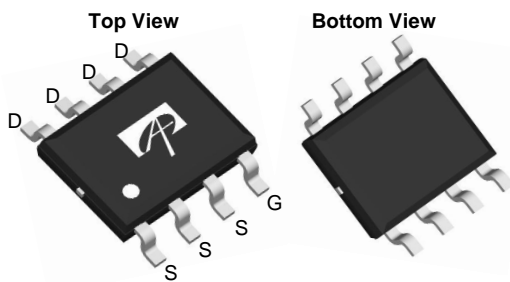

SRFET™
 Soft Recovery MOSFET:
 Integrated Schottky Diode

Absolute Maximum Ratings $T_A=25^\circ C$ unless otherwise noted

Parameter	Symbol	Maximum	Units
Drain-Source Voltage	V_{DS}	30	V
Gate-Source Voltage	V_{GS}	± 12	V
Continuous Drain Current ^{AF}	$T_A=25^\circ C$	16.5	A
	$T_A=70^\circ C$	13.2	
Pulsed Drain Current ^B	I_{DM}	100	A
Avalanche Current ^B	I_{AR}	30	A
Repetitive avalanche energy $L=0.3mH$ ^B	E_{AR}	135	mJ
Power Dissipation	$T_A=25^\circ C$	3.1	W
	$T_A=70^\circ C$	2.0	
Junction and Storage Temperature Range	T_J, T_{STG}	-55 to 150	$^\circ C$

Thermal Characteristics

Parameter	Symbol	Typ	Max	Units
Maximum Junction-to-Ambient ^A	$R_{\theta JA}$	31	40	$^\circ C/W$
Maximum Junction-to-Ambient ^A		Steady-State	59	75
Maximum Junction-to-Lead ^C	$R_{\theta JL}$	16	24	$^\circ C/W$

Electrical Characteristics (T_J=25°C unless otherwise noted)

Symbol	Parameter	Conditions	Min	Typ	Max	Units
STATIC PARAMETERS						
B _V DSS	Drain-Source Breakdown Voltage	I _D =1mA, V _{GS} =0V	30			V
I _{DSS}	Zero Gate Voltage Drain Current	V _{DS} =30V, V _{GS} =0V T _J =125°C		0.02 10	0.1 20	mA
I _{GSS}	Gate-Body leakage current	V _{DS} =0V, V _{GS} = ±12V			0.1	μA
V _{GS(th)}	Gate Threshold Voltage	V _{DS} =V _{GS} I _D =250μA	1.5	1.85	2.4	V
I _{D(ON)}	On state drain current	V _{GS} =10V, V _{DS} =5V	100			A
R _{DS(ON)}	Static Drain-Source On-Resistance	V _{GS} =10V, I _D =16.5A T _J =125°C		5.6 8.4	6.8 10.5	mΩ
		V _{GS} =4.5V, I _D =15A		6.8	8.2	mΩ
g _{FS}	Forward Transconductance	V _{DS} =5V, I _D =16.5A		112		S
V _{SD}	Diode Forward Voltage	I _S =1A, V _{GS} =0V		0.37	0.5	V
I _S	Maximum Body-Diode + Schottky Continuous Current				5	A
DYNAMIC PARAMETERS						
C _{iss}	Input Capacitance	V _{GS} =0V, V _{DS} =15V, f=1MHz		4000	5000	pF
C _{oss}	Output Capacitance			520		pF
C _{rss}	Reverse Transfer Capacitance			217		pF
R _g	Gate resistance	V _{GS} =0V, V _{DS} =0V, f=1MHz		0.6	0.9	Ω
SWITCHING PARAMETERS						
Q _{g(10V)}	Total Gate Charge	V _{GS} =10V, V _{DS} =15V, I _D =17A		59	77	nC
Q _{g(4.5V)}	Total Gate Charge			27	35	nC
Q _{gs}	Gate Source Charge			12		nC
Q _{gd}	Gate Drain Charge			11		nC
t _{D(on)}	Turn-On DelayTime	V _{GS} =10V, V _{DS} =15V, R _L =0.9Ω, R _{GEN} =3Ω		9		ns
t _r	Turn-On Rise Time			9		ns
t _{D(off)}	Turn-Off DelayTime			37		ns
t _f	Turn-Off Fall Time			8		ns
t _{rr}	Body Diode Reverse Recovery Time		I _F =16.5A, di/dt=300A/μs		17	20
Q _{rr}	Body Diode Reverse Recovery Charge	I _F =16.5A, di/dt=300A/μs		21		nC

A: The value of R_{θJA} is measured with the device mounted on 1 in² FR-4 board with 2oz. Copper, in a still air environment with T_A=25°C. The value in any given application depends on the user's specific board design.

B: Repetitive rating, pulse width limited by junction temperature T_{J(MAX)}=150°C.

C: The R_{θJA} is the sum of the thermal impedance from junction to lead R_{θJL} and lead to ambient.

D: The static characteristics in Figures 1 to 6 are obtained using <300 μs pulses, duty cycle 0.5% max.

E: These tests are performed with the device mounted on 1 in 2 FR-4 board with 2oz. Copper, in a still air environment with T_A=25°C. The SOA curve provides a single pulse rating.

F: The current rating is based on the t ≤ 10s thermal resistance rating.

Rev4: Nov. 2010

THIS PRODUCT HAS BEEN DESIGNED AND QUALIFIED FOR THE CONSUMER MARKET. APPLICATIONS OR USES AS CRITICAL COMPONENTS IN LIFE SUPPORT DEVICES OR SYSTEMS ARE NOT AUTHORIZED. AOS DOES NOT ASSUME ANY LIABILITY ARISING OUT OF SUCH APPLICATIONS OR USES OF ITS PRODUCTS. AOS RESERVES THE RIGHT TO IMPROVE PRODUCT DESIGN, FUNCTIONS AND RELIABILITY WITHOUT NOTICE.

TYPICAL ELECTRICAL AND THERMAL CHARACTERISTICS

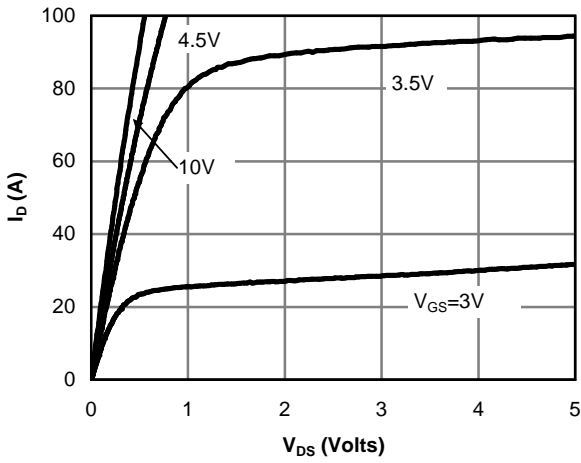

Figure 1: On-Region Characteristics

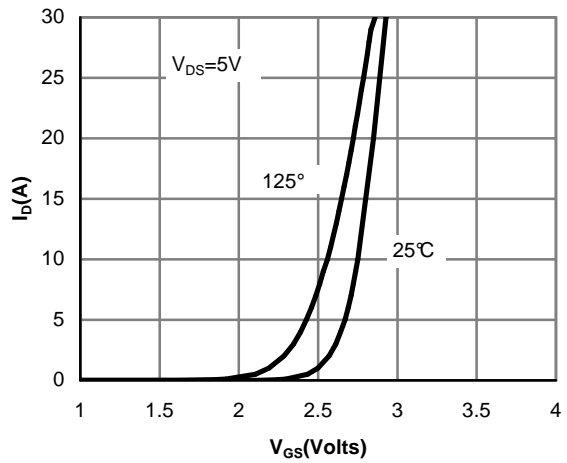

Figure 2: Transfer Characteristics

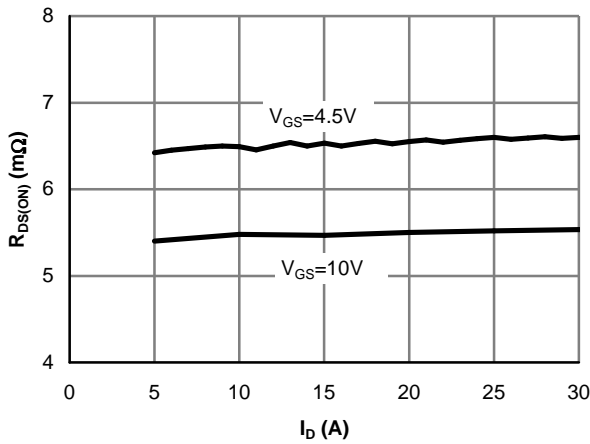

Figure 3: On-Resistance vs. Drain Current and Gate Voltage

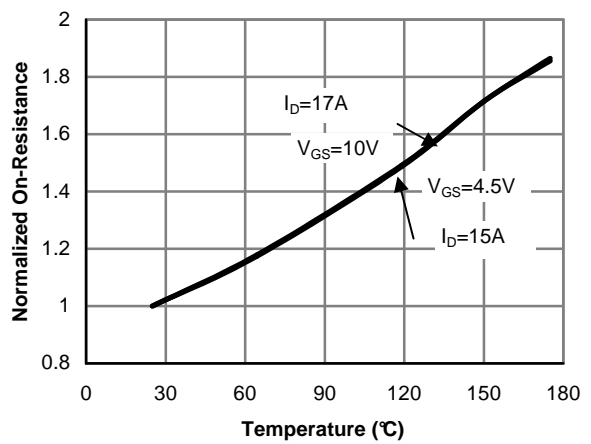

Figure 4: On-Resistance vs. Junction Temperature

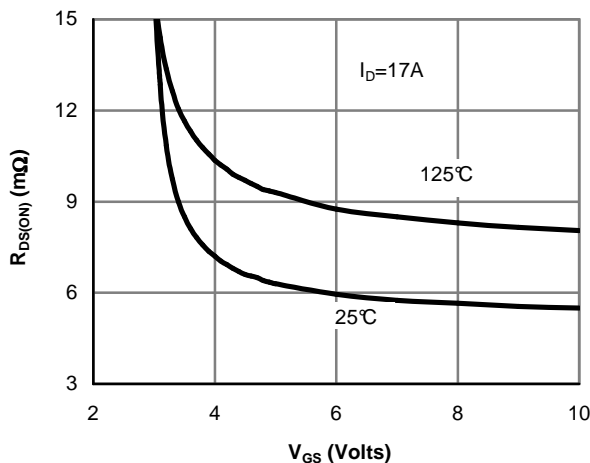

Figure 5: On-Resistance vs. Gate-Source Voltage

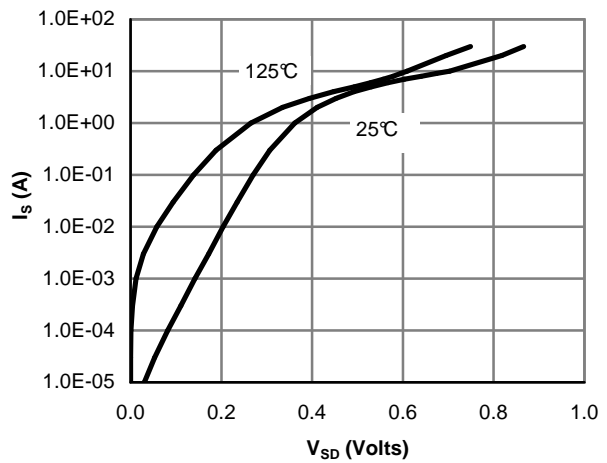

Figure 6: Body-Diode Characteristics

TYPICAL ELECTRICAL AND THERMAL CHARACTERISTICS

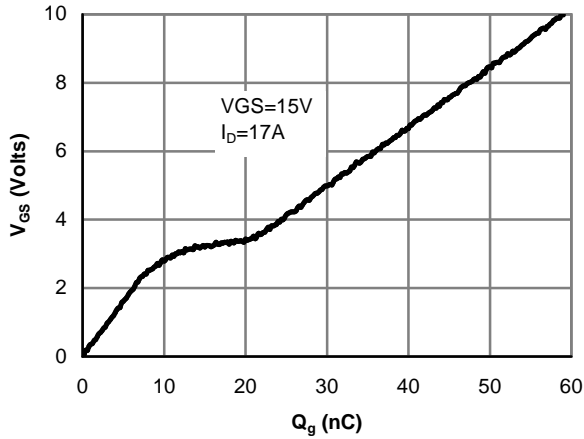

Figure 7: Gate-Charge Characteristics

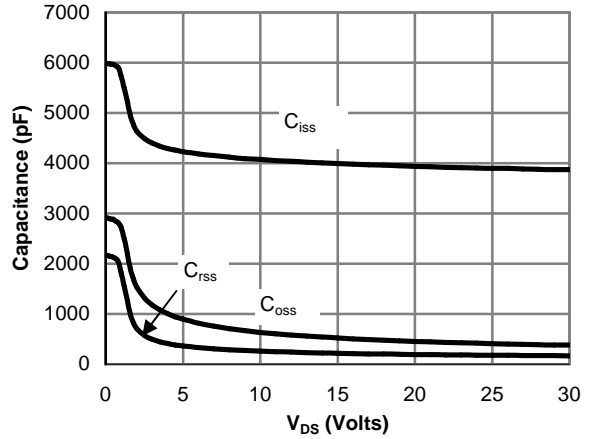

Figure 8: Capacitance Characteristics

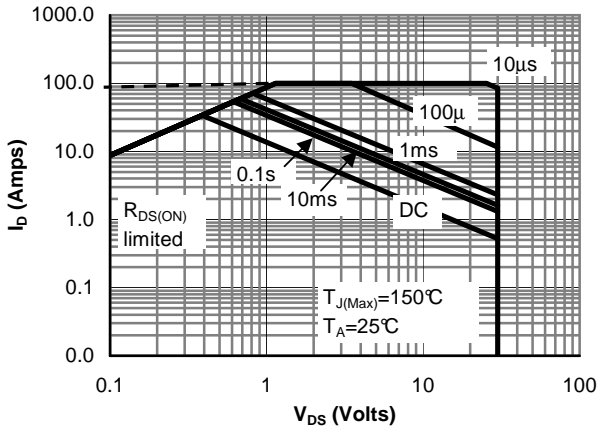

Figure 9: Maximum Forward Biased Safe Operating Area (Note E)

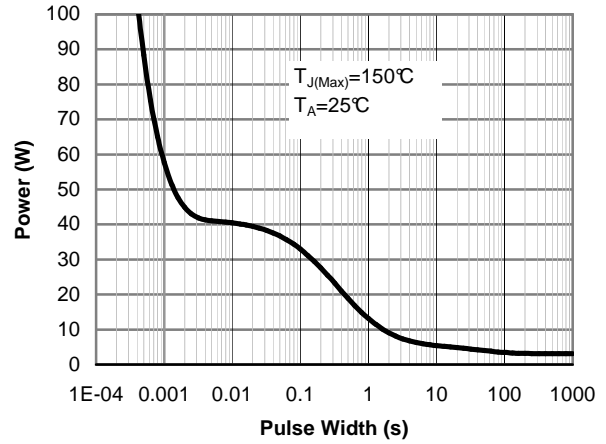

Figure 10: Single Pulse Power Rating Junction-to-Ambient (Note E)

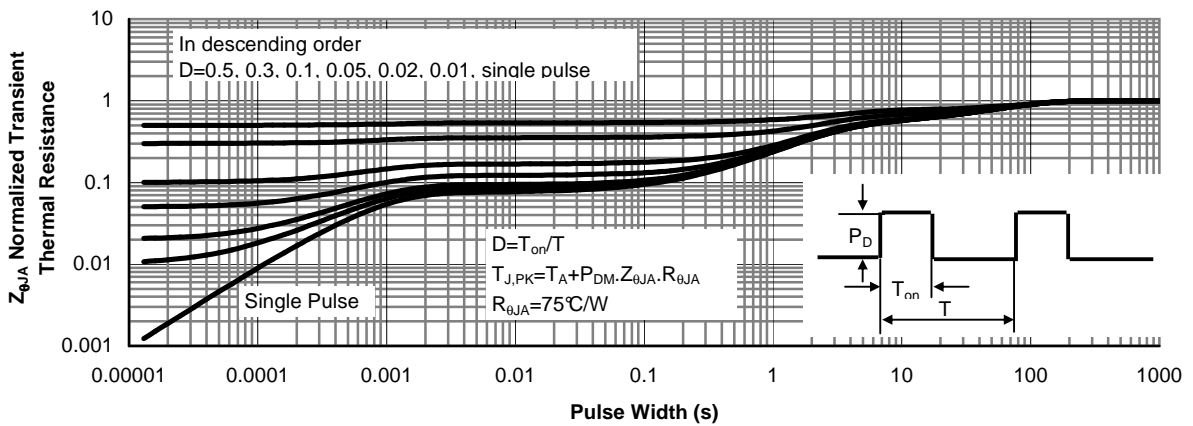

Figure 11: Normalized Maximum Transient Thermal Impedance (Note E)

TYPICAL ELECTRICAL AND THERMAL CHARACTERISTICS

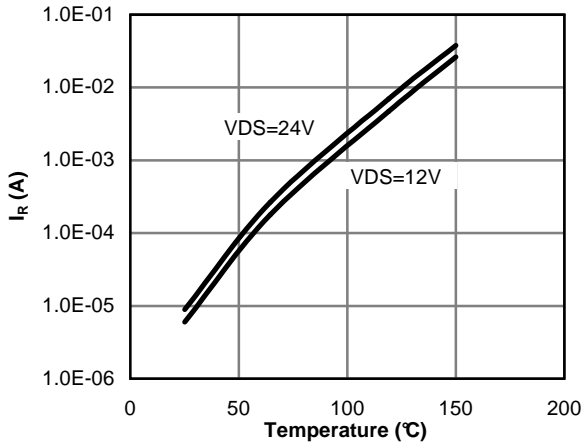

Figure 12: Diode Reverse Leakage Current vs. Junction Temperature

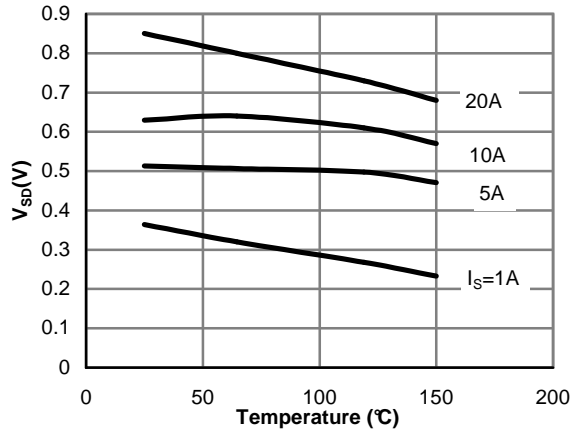

Figure 13: Diode Forward voltage vs. Junction Temperature

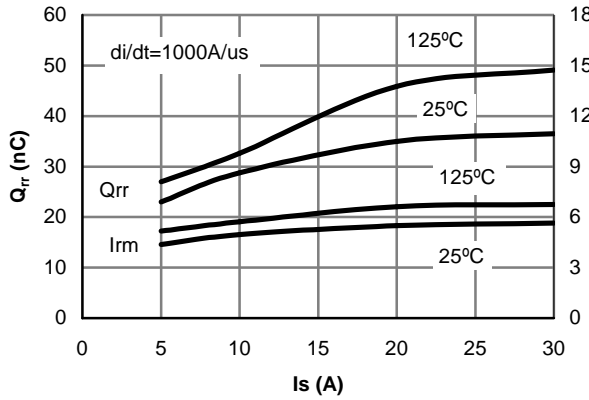

Figure 14: Diode Reverse Recovery Charge and Peak Current vs. Conduction Current

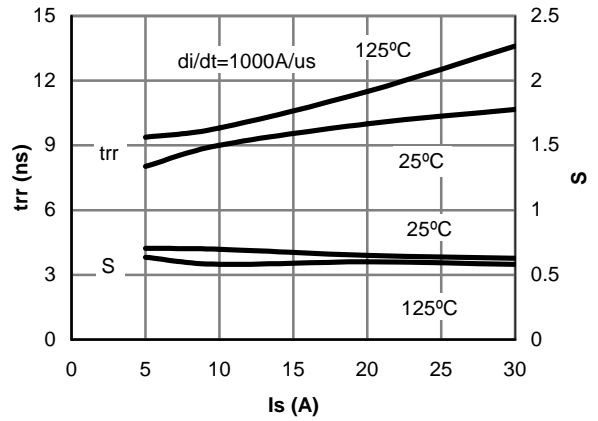

Figure 15: Diode Reverse Recovery Time and Soft Coefficient vs. Conduction Current

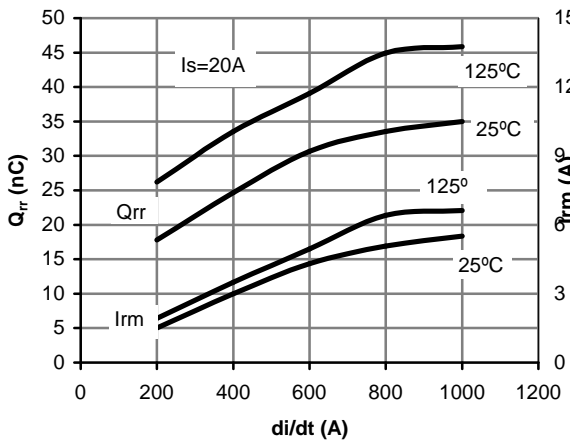

Figure 16: Diode Reverse Recovery Charge and Peak Current vs. di/dt

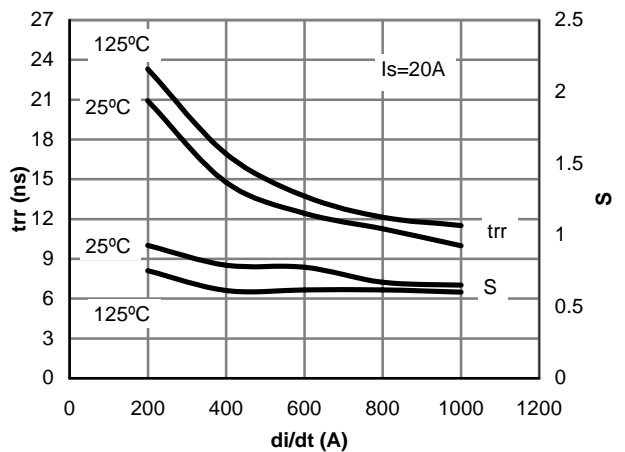
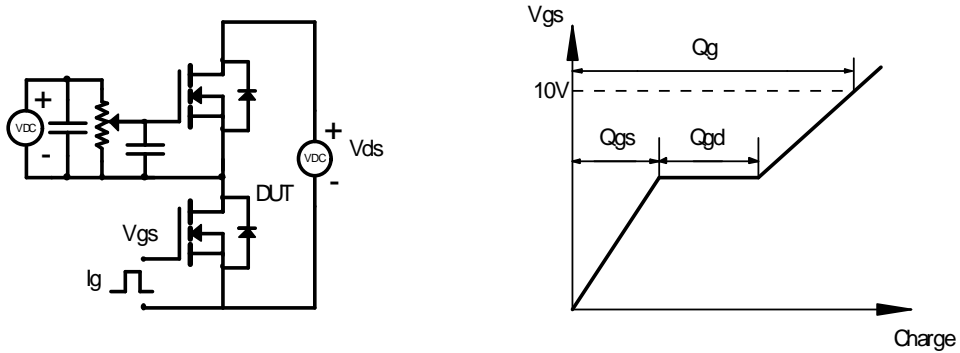
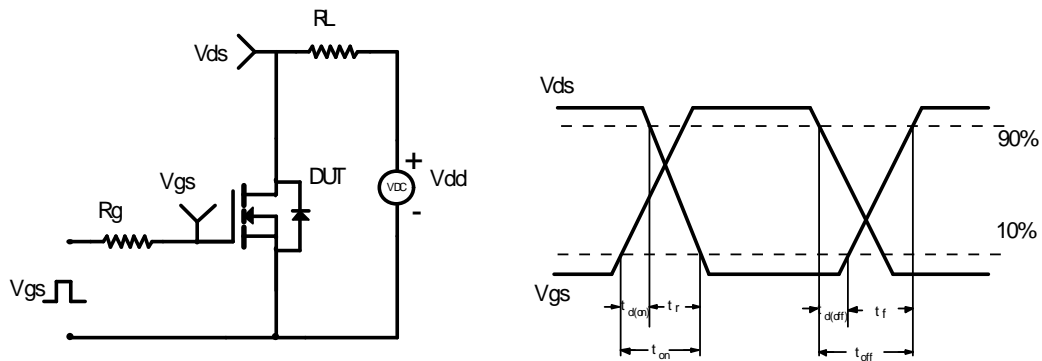

Figure 17: Diode Reverse Recovery Time and Soft Coefficient vs. di/dt

Gate Charge Test Circuit & Waveform



Resistive Switching Test Circuit & Waveforms



Unclamped Inductive Switching (UIS) Test Circuit & Waveforms

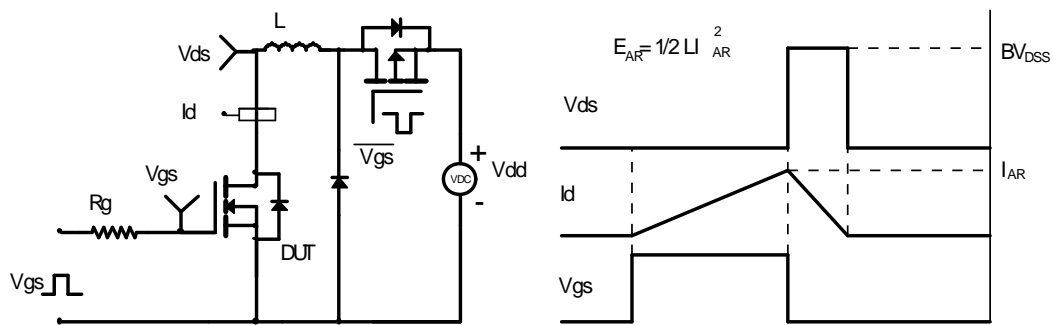

Diode Recovery Test Circuit & Waveforms

