

# 643 series



## features



- Ø8.1mm mounting
- Black anodised aluminium housing
- Colour diffused lens
- Short body length is ideal for portable equipment
- Wide viewing angle
- Sealed to IP67
- Suitable for high vibration applications
- Pack Quantity = 10 Pieces

## specifications

Typical characteristics (Ta = 25°C)

Part Number	Colour	Voltage Vac/dc	Current DC (mA)	Luminous Intensity (mcd)	Wave Length (nm)	Operating Temp. (°C)	Storage Temp. (°C)	De-rating Graphs
643-503-04	Red	2.0 Vdc	20	80	625	-40 - +85	-40 - +85	B
643-509-04	Yellow	2.1 Vdc	20	45	590	-40 - +85	-40 - +85	B
643-512-04	Green	2.2 Vdc	20	45	565	-40 - +85	-40 - +85	C
643-501-04	Red	2.0 Vdc	20	600	630	-40 - +80	-40 - +100	D
643-521-04	Yellow	2.1 Vdc	20	600	585	-40 - +80	-40 - +100	D
643-532-04	Green	3.4 Vdc	20	800	515	-40 - +80	-40 - +100	F
643-930-04	Blue	3.4 Vdc	20	9870	465	-30 - +85	-40 - +100	U

^ = Voltage for 20mA product is Vf at 20mA, not Vopr

- Products must be de-rated according to the de-rating information. Each de-rating graph refers to specific LEDs. Please refer to graphs on page 3.

- Luminous intensity is measured at 20mA on a discrete LED unless otherwise stated.

## to order

**to order please contact us on: t: +44 (0)1229 582 430**

**f: +44 (0)1229 585 155 e: sales@marl.co.uk w: www.leds.co.uk**

© marl international limited technical documentation has been designed by marl international limited for the intention of providing information, which must not be copied or released to a third party without prior written consent from marl international limited. the information provided does not constitute part of any order or contract and should not be regarded as a representation relating to either products or service. no responsibility can be assumed for inaccuracies or printing errors. marl international limited reserve the right to alter without notice the specification or any conditions of supply for product or service.



high performance panel lamps

# 643 series



## technical data

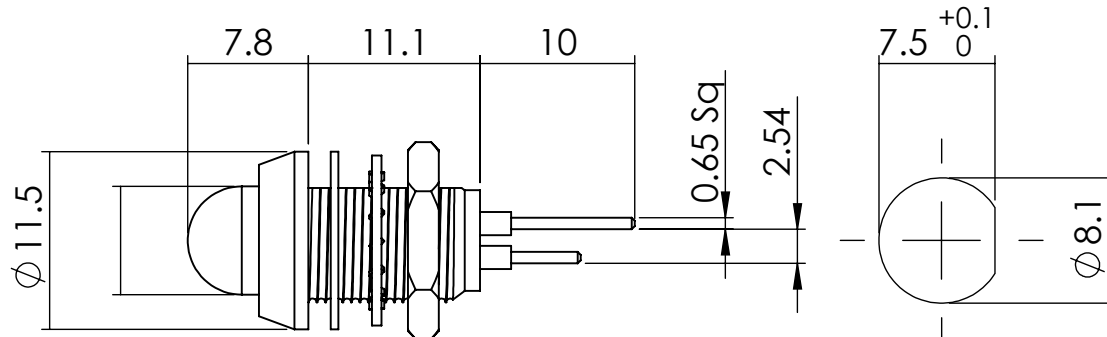

Dimensions in mm (typical)  
Not to scale

Anode termination denoted by red indicator  
Mounting hole to be clean and burr free

## housing material

## push on connectors

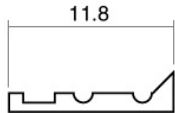
<b>Body</b> <b>Nut</b> <b>Panel Seal</b> <b>Fresnel Lens</b> <b>Encapsulation</b> <b>Lock Washer</b> <b>Termination</b> <b>Header</b>	Black Anodised Aluminium Bright Nickel Plated Brass Viton Polycarbonate PC5430 Resin Spring Steel - -	 909-000-00 is gold plated, 910-000-00 is tin plated - for use with 643 series lamps. Dimensions in mm (typical). Not to scale.
--	--	--

## technical characteristics

Series	Max. Power Dissipation	Max. Reverse Voltage	Panel Cutout	Nut Mounting Torque	Min. Mounting Centres	Max. Panel Thickness
643	75	3*	8.1	0.6	14.5	1.5 - 5.0
<b>units</b>	mW	Vdc	mm	Nm	mm	mm

\* = Current Version      ^ = Voltage Version

## optional flying lead terminations

Order Code Suffix	Supply Voltage	Wire Colour	Wire Length	No/Diameter of Conductor	Diameter Insulation	Comments
19	DC products	Red-anode/ Black-cathode	1000mm	19/0.15mm	1.2mm	Customised lengths available

## to order

**to order please contact us on: t: +44 (0)1229 582 430 f: +44 (0)1229 585 155**  
**e: sales@marl.co.uk w: www.leds.co.uk**

© marl international limited technical documentation has been designed by marl international limited for the intention of providing information, which must not be copied or released to a third party without prior written consent from marl international limited. the information provided does not constitute part of any order or contract and should not be regarded as a representation relating to either products or service. no responsibility can be assumed for inaccuracies or printing errors. marl international limited reserve the right to alter without notice the specification or any conditions of supply for product or service.



BS EN ISO 9001:2008 approved manufacturer

# 643 series



## de-rating information

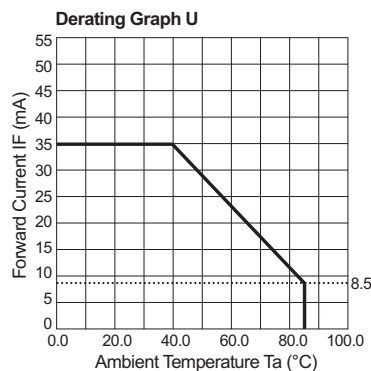
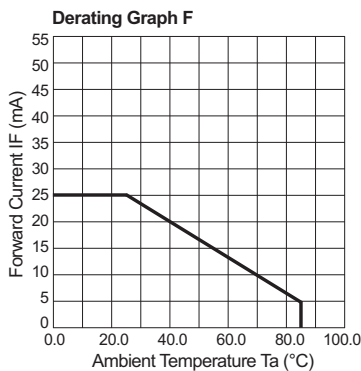
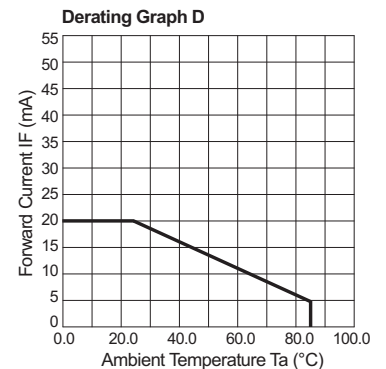
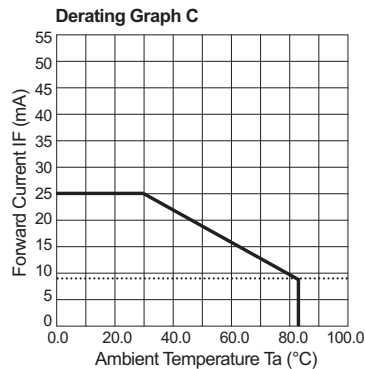
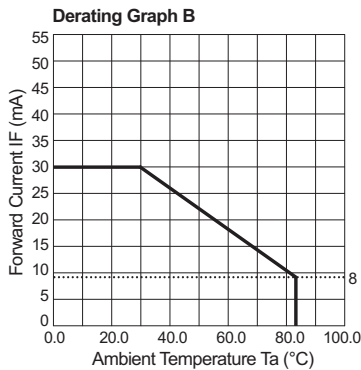

## also available

Part numbers also available in the 643 series:

Part Number	Colour	Voltage Vopr
643-501-04-50	Red	20 mA dc
643-501-04-51	Red	20 mA dc
643-521-04-51	Yellow	20 mA dc
643-530-04-51	-	20 mA dc
643-532-04-51	Green	20 mA dc
643-535-04-15	Red/Green	20 mA dc
643-535-04-50	Red/Green	20 mA dc
643-930-04-51	Blue	20 mA dc
643-997-04-51	White	20 mA dc

The products listed here illustrate all of the options available to order. These products may have custom modifications that alter their operation beyond the generic information contained within this datasheet. Please contact sales for further information.

\* = These products do not contain integral resistors

## to order

to order please contact us on: t: +44 (0)1229 582 430 f: +44 (0)1229 585 155  
e: [sales@marl.co.uk](mailto:sales@marl.co.uk) w: [www.leds.co.uk](http://www.leds.co.uk)

© marl international limited technical documentation has been designed by marl international limited for the intention of providing information, which must not be copied or released to a third party without prior written consent from marl international limited. the information provided does not constitute part of any order or contract and should not be regarded as a representation relating to either products or service. no responsibility can be assumed for inaccuracies or printing errors. marl international limited reserve the right to alter without notice the specification or any conditions of supply for product or service.



# 643 series



## design considerations

### Electro-Static Discharge (ESD)

Build up of electro-static discharge occurs in many situations involving people moving and handling products. The range of possible situations is very diverse but voltage levels as high as several thousand volts can and do arise in many individual situations. When an operator charged up to these levels handles a static sensitive device, there is a very probable likelihood that the device will be irreversibly damaged. It is essential that precautions are taken at all stages during manufacture and assembly of these products. Although LEDs were never considered to be static sensitive devices, changes in manufacturing technology and materials used to produce higher intensity products over a large range of the wavelength spectrum have changed this. Marl has an approved system of ESD control from goods in, through production and into final packing and despatch. Marl recommend all users of LED based products follow the guidelines of BS 100015.

### Power De-Rating

The forward voltage/ current value of an LED is dependant upon the ambient temperature of the environment in which it is operated. Therefore, care must be taken to operate the LED at the correct voltage/ current values, depending upon the ambient temperature. Consequently, a recommendation regarding operating voltages and currents is given in order to address these temperature effects. This recommendation is termed 'de-rating'. It is usual for forward voltages and currents to be specified for ambient temperature of 25°C. However, because the values of these qualities vary with temperature, please refer to the de-rating graphs for correct operation. Marl accept no liability for any product that is operated higher than the stated voltage.

## to order

**to order please contact us on: t: +44 (0)1229 582 430 f: +44 (0)1229 585 155  
e: [sales@marl.co.uk](mailto:sales@marl.co.uk) w: [www.leds.co.uk](http://www.leds.co.uk)**

© marl international limited technical documentation has been designed by marl international limited for the intention of providing information, which must not be copied or released to a third party without prior written consent from marl international limited. the information provided does not constitute part of any order or contract and should not be regarded as a representation relating to either products or service. no responsibility can be assumed for inaccuracies or printing errors. marl international limited reserve the right to alter without notice the specification or any conditions of supply for product or service.

