

Key Parameters

V_{DSM}	=	5200 V
I_{TAVM}	=	1700 A
I_{TRMS}	=	2670 A
I_{TSM}	=	29000 A
V_{TO}	=	1.02 V
r_T	=	0.320 mΩ

Phase Control Thyristor

5STP 17L5200

Doc. No. 5SYA 1005-02 Dec.95

Features

- Patented free-floating silicon technology
- Designed for traction, energy and industrial applications
- Optimum power handling capability

Blocking

Part number	5STP 17L5200	5STP 17L5000	5STP 17L4600	Conditions
V_{DSM} V_{RSM}	5200 V	5000 V	4600 V	$f = 5\text{Hz}$, $t_p = 10\text{ms}$
V_{DRM} V_{RRM}	4400 V	4200 V	4000 V	$f = 50\text{Hz}$, $t_p = 10\text{ms}$
V_{RSM1}	5700 V	5500 V	5100 V	$t_p = 5\text{ms}$, single pulse
I_{DSM}	$\leq 400\text{ mA}$			V_{DSM}
I_{RSM}	$\leq 400\text{ mA}$			V_{RSM}
dv/dt_{crit}	2000 V/ μs			@ Exp.to 0.67x V_{DRM}
$T_{vj} = 125^\circ\text{C}$				

V_{DRM}/V_{RRM} are equal to V_{DSM}/V_{RSM} values up to $T_{vj} = 110^\circ\text{C}$.

Mechanical data

F_m	Mounting force	nom	50 kN
		min	45 kN
		max	60 kN
a	Acceleration Device clamped		100 m/s ²
m	Weight		1.35 kg
D_s	Surface creepage distance		35 mm
D_a	Air strike distance		14 mm

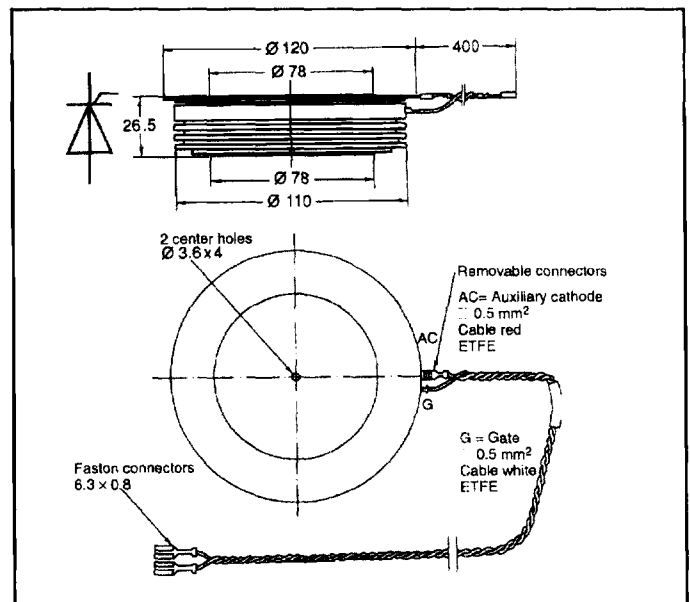

On-state

I_{TAVM}	Max. average on-state current	1700 A	Half sine wave, $T_c = 70^\circ\text{C}$	
I_{TRMS}	Max. RMS on-state current	2670 A		
I_{TSM}	Max. peak non-repetitive surge current	29000 A	$t_p = 10\text{ ms}$	$T_{vj} = 125^\circ\text{C}$
		31000 A	$t_p = 8.3\text{ ms}$	
I^2t	Limiting load integral	4205 kA ² s	$t_p = 10\text{ ms}$	
		3990 kA ² s	$t_p = 8.3\text{ ms}$	
V_T	On-state voltage	1.68 V	$I_T = 2000\text{ A}$	
V_{TO}	Threshold voltage	1.02 V		
r_T	Slope resistance	0.320 m Ω	$I_T = 1000 - 3000\text{ A}$	
I_H	Holding current	20-70 mA	$T_{vj} = 25^\circ\text{C}$	
		15-60 mA	$T_{vj} = 125^\circ\text{C}$	
I_L	Latching current	80-300 mA	$T_{vj} = 25^\circ\text{C}$	
		70-250 mA	$T_{vj} = 125^\circ\text{C}$	

Switching

di/dt_{crit}	Critical rate of rise of on-state current	100 A/ μs	Cont.	$V_D \leq 0.67 \times V_{DRM}$ $T_{vj} = 125^\circ\text{C}$ $I_{TRM} = 3000\text{ A}$ $f = 50\text{ Hz}$ $I_{FG} = 2.0\text{ A}$ $t_r = 0.5\mu\text{s}$
		200 A/ μs	60 sec.	
t_d	Delay time	$\leq 3.0\ \mu\text{s}$	$V_D = 0.4 \times V_{DRM}$	$I_{FG} = 2.0\text{ A}$ $t_r = 0.5\mu\text{s}$
t_q	Turn-off time	$\leq 700\ \mu\text{s}$	$V_D \leq 0.67 \times V_{DRM}$ $dv_D/dt = 20\text{ V}/\mu\text{s}$	$I_{TRM} = 3000\text{ A}$ $T_{vj} = 125^\circ\text{C}$ $V_R > 200\text{ V}$
Q	Recovery charge	min	4800 μAs	$di_T/dt = -5\text{ A}/\mu\text{s}$
		max	6200 μAs	

Triggering

V_{GT}	Gate trigger voltage	2.6 V	$T_{vj} = 25^\circ\text{C}$
I_{GT}	Gate trigger current	400 mA	$T_{vj} = 25^\circ\text{C}$
V_{GD}	Gate non-trigger voltage	0.3 V	$V_D = 0.4 \times V_{DRM}$
I_{GD}	Gate non-trigger DC current	10 mA	$V_D = 0.4 \times V_{DRM}$
V_{FGM}	Peak forward gate voltage	12 V	
I_{FGM}	Peak forward gate current	10 A	
V_{RGM}	Peak reverse gate voltage	10 V	
P_G	Gate power losses	3 W	

Thermal

$T_{vj \max}$	Max. junction temperature	125 °C	
$T_{vj \text{ stg}}$	Storage temperature range	-40...150°C	
R_{thJC}	Thermal resistance junction to case	24 K/kW	Anode side cooled
		24 K/kW	Cathode side cooled
		12 K/kW	Double side cooled
R_{thCH}	Thermal resistance case to heat sink	10 K/kW	Single side cooled
		5 K/kW	Double side cooled

Analytical function for transient thermal impedance:

$$Z_{thJC} = \sum_{i=1}^n R_i(1 - e^{-t/\tau_i})$$

i	1	2	3	4
R_i (K/W)	0.0053	0.0051	0.0016	
τ_i (s)	2.1838	0.4151	0.0324	

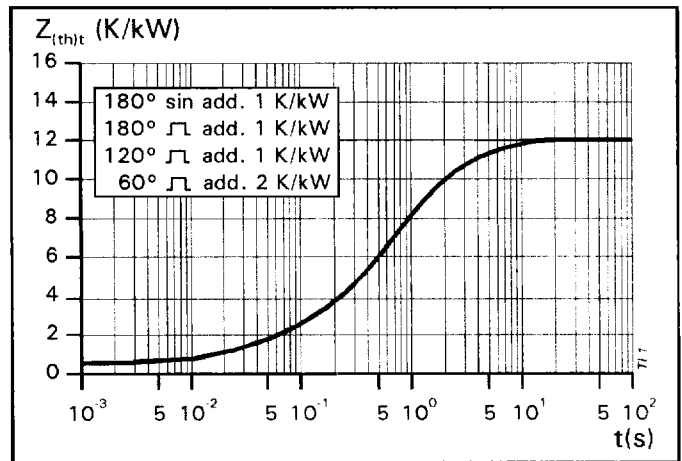

Fig.1 Transient thermal impedance, junction to case.

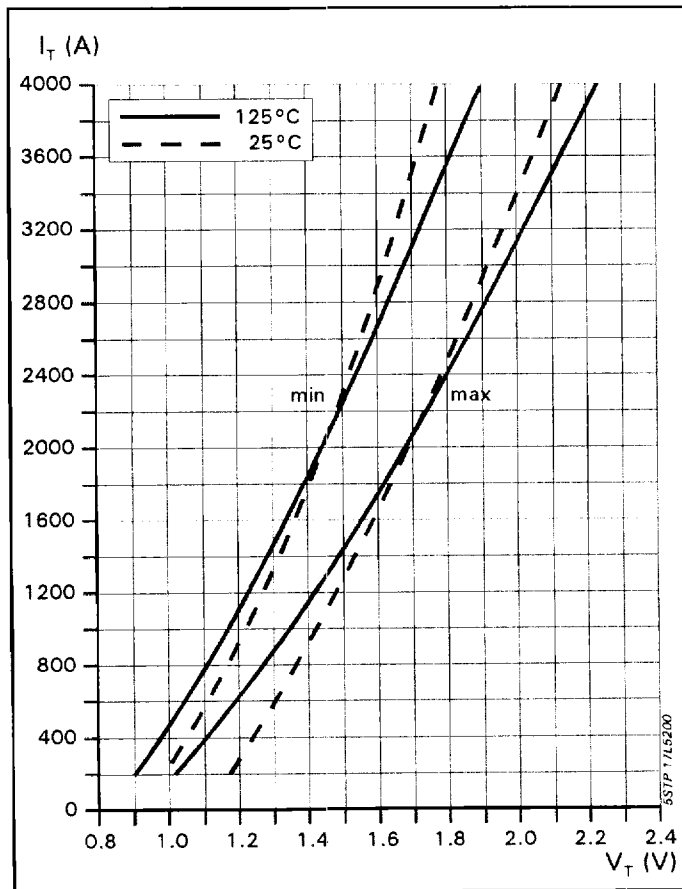

Fig.2 On-state characteristics.

Voltage drop model: $V_T = A + B \cdot i_T + C \cdot \ln(i_T + 1) + D \cdot \sqrt{i_T}$

Valid for $I_T = 500 - 4000$ A

A	B	C	D
1.309000	0.000080	-0.125000	0.026000

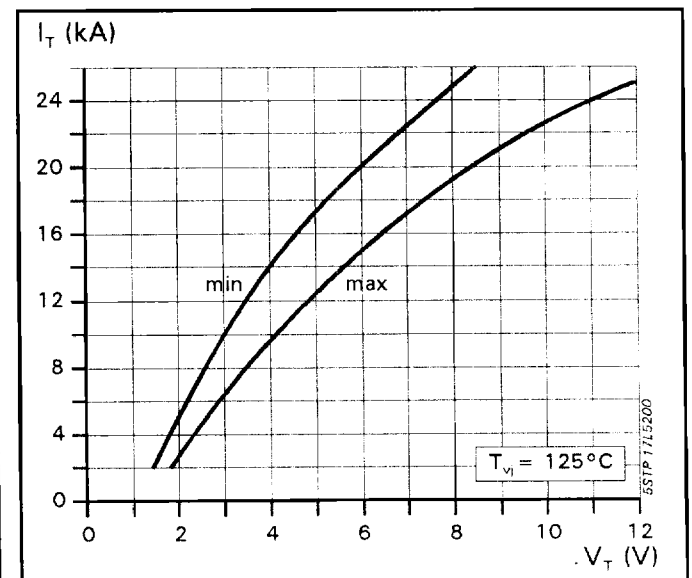

Fig.3 On-state characteristics.

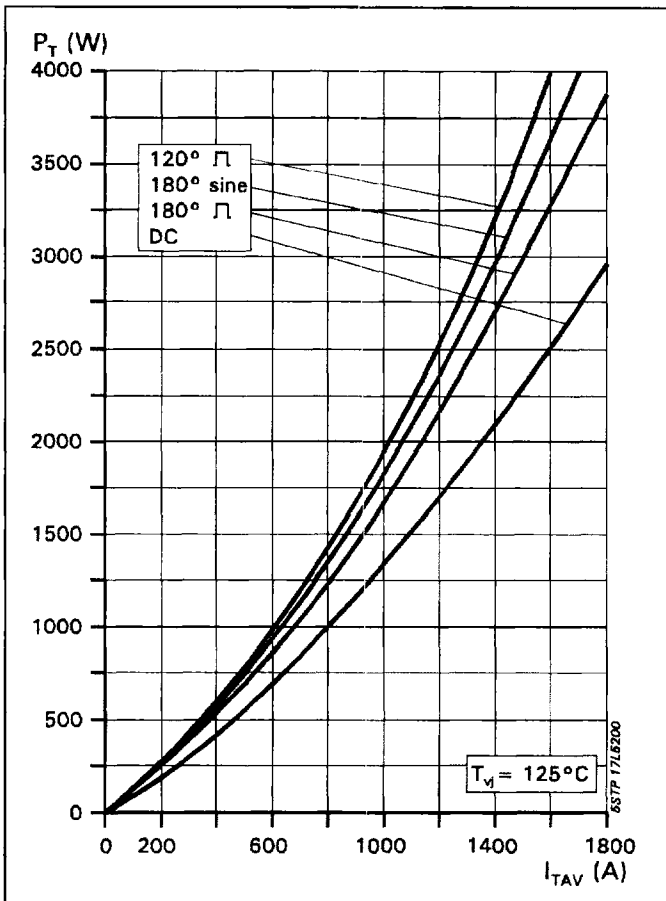

Fig.4 On-state power loss vs mean on-state current. Turn-on losses excluded.

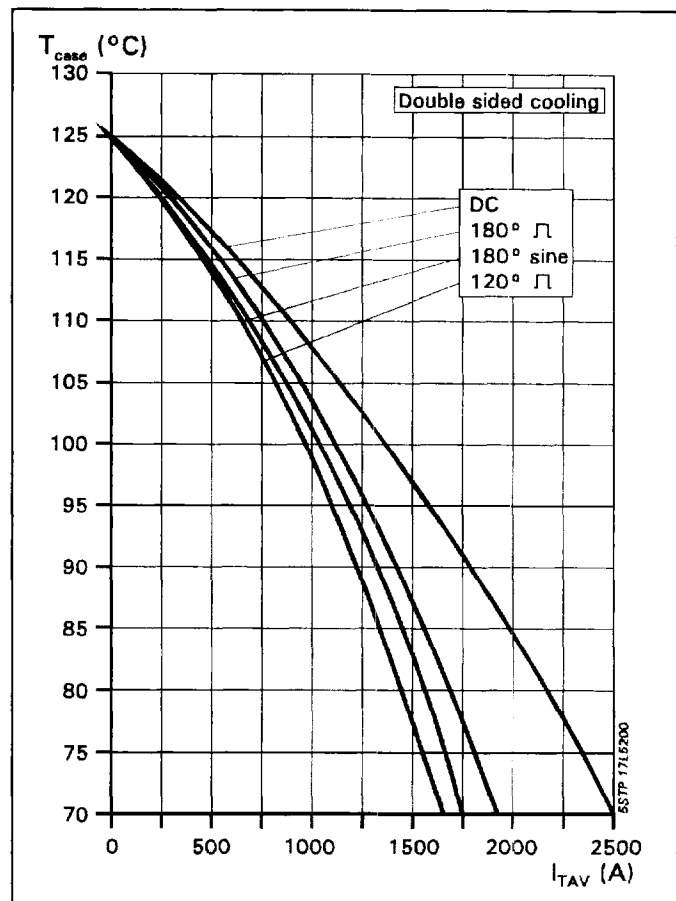

Fig.5 Max. permissible case temperature vs mean on-state current.

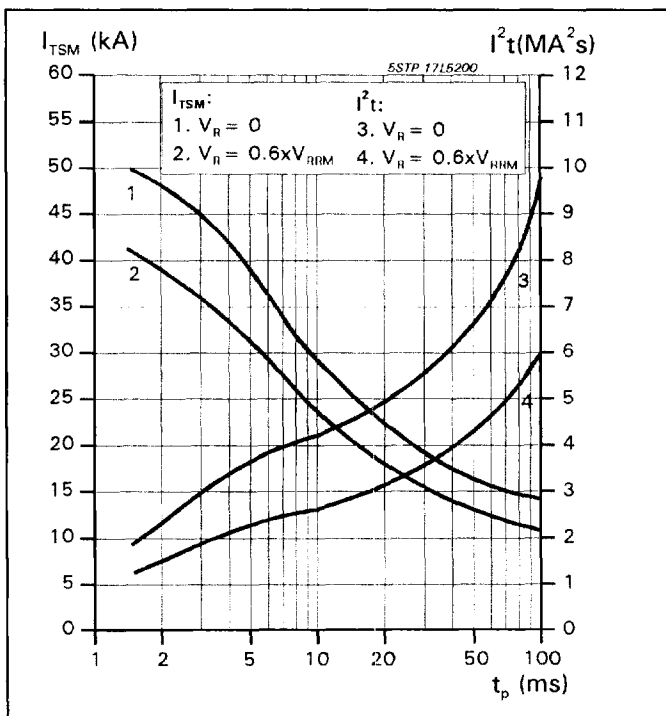

Fig.6 Surge on-state current vs pulse length. Half-sine wave.

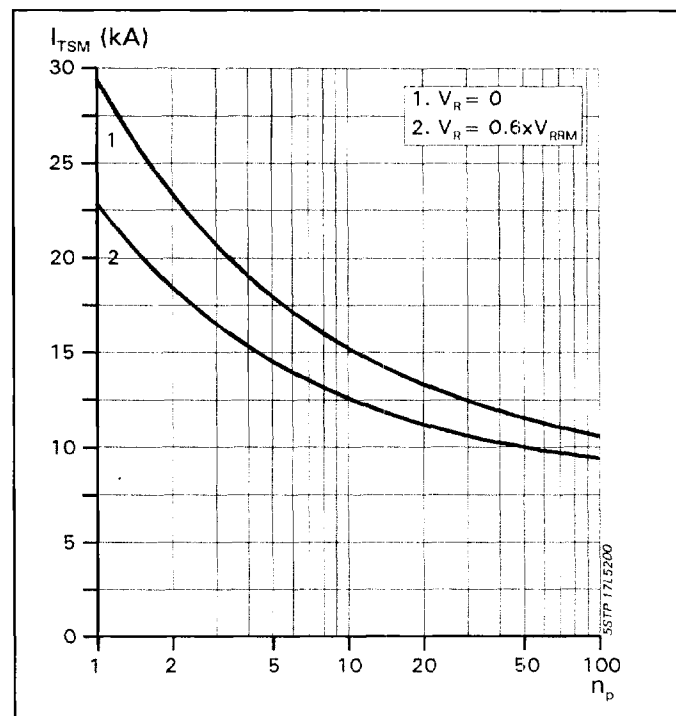

Fig.7 Surge on-state current vs number of pulses. Half-sine wave, 10ms, 50Hz.

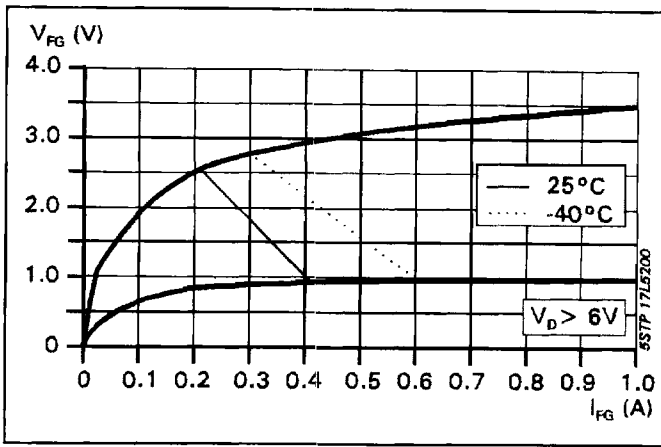

Fig.8 Gate trigger characteristics.

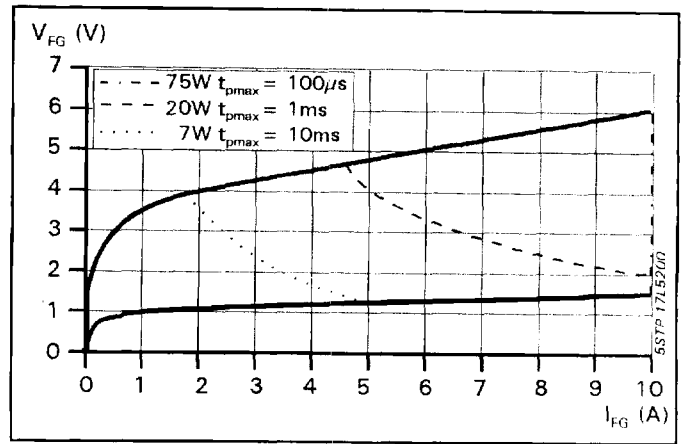

Fig.9 Max. peak gate power loss.

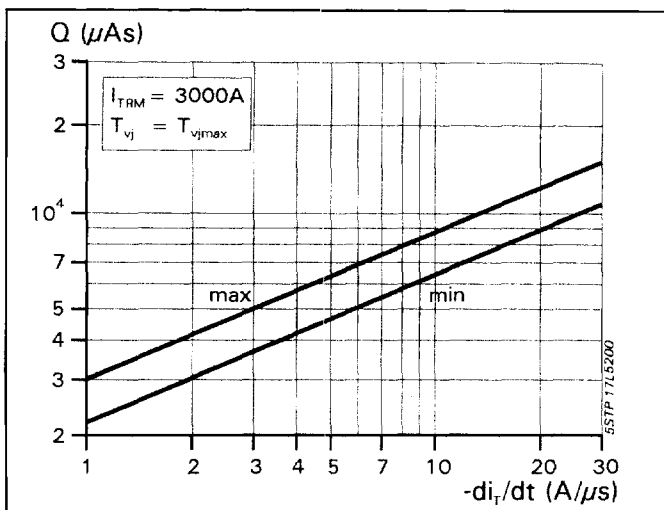

Fig.10 Recovery charge vs decay rate of on-stat current.

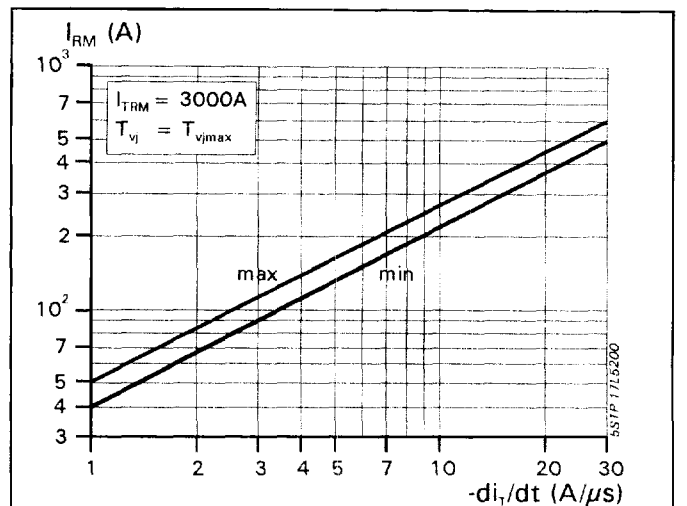

Fig.11 Peak reverse recovery current vs decay rate of on-state current.

Turn-off time, typical parameter relationship

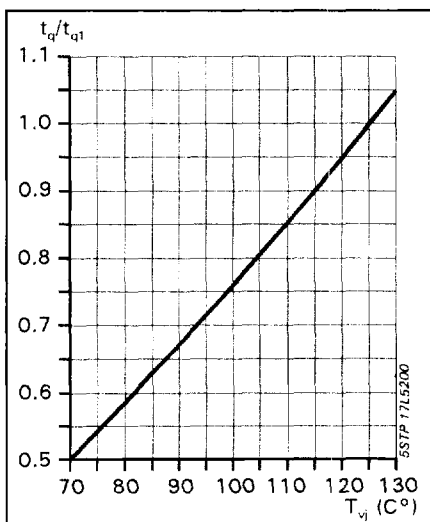

Fig.12 $t_q/t_{q1} = f(T_{vj})$

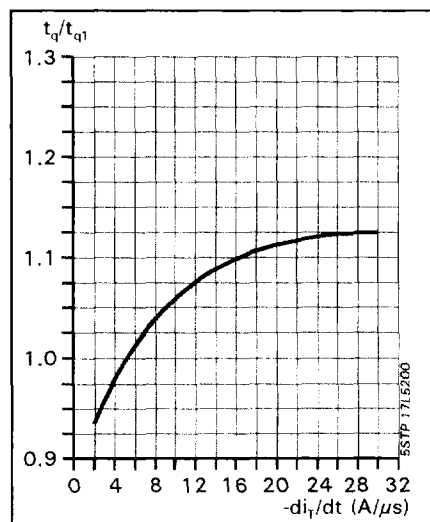

Fig.13 $t_q/t_{q1} = f(-di/dt)$

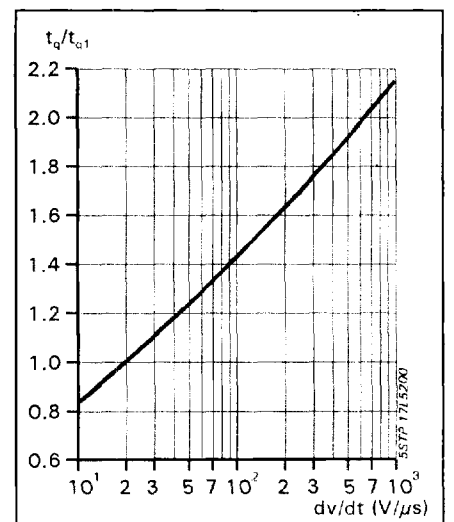

Fig.14 $t_q/t_{q1} = f(dv/dt)$

$t_q = t_{q1} * t_q/t_{q1}(T_{vj}) * t_q/t_{q1}(-di/dt) * t_q/t_{q1}(dv/dt)$

t_{q1} : at normalized value (see page 2).
 t_q : at varying conditions.

Turn-on and Turn-off losses

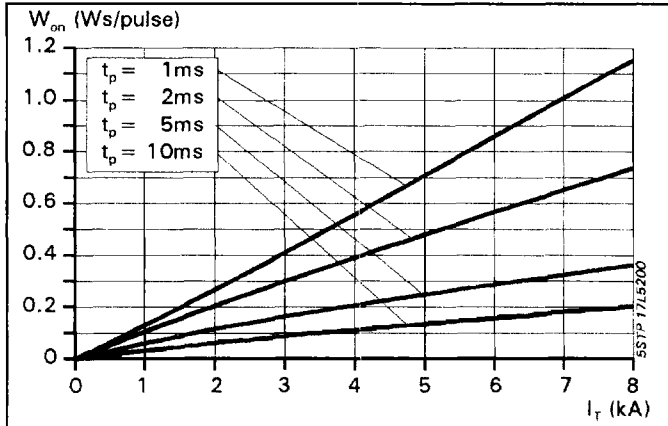

Fig.15 $W_{on} = f(I_T, t_p)$, $T_{vj} = 125^\circ\text{C}$. Half sinusoidal waves.

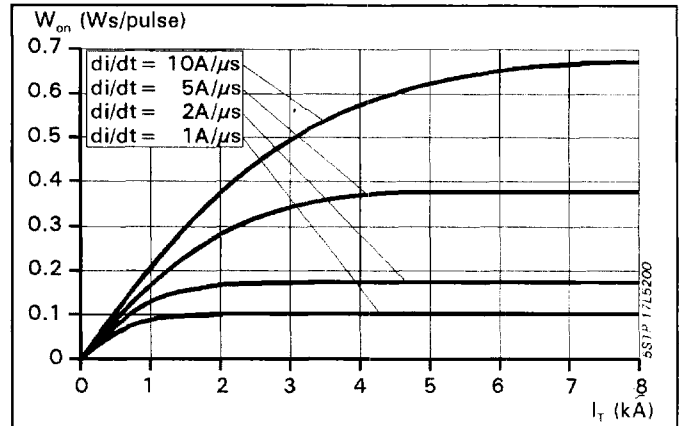

Fig.16 $W_{on} = f(I_T, di/dt)$, $T_{vj} = 125^\circ\text{C}$. Rectangular waves.

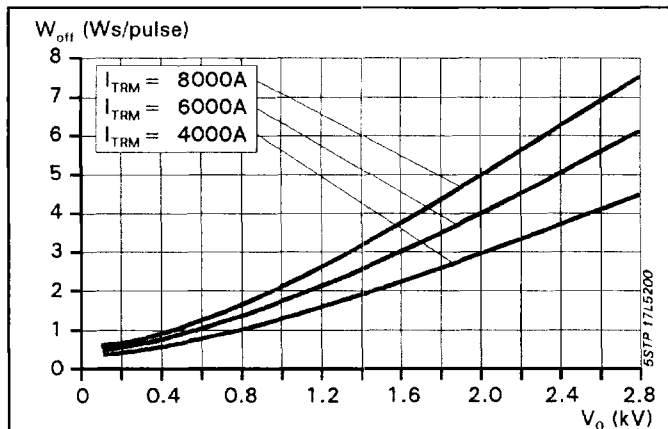

Fig.17 $W_{off} = f(V_o, I_T)$, $T_{vj} = 125^\circ\text{C}$. Half sinusoidal waves. $T_p = 10\text{ms}$.

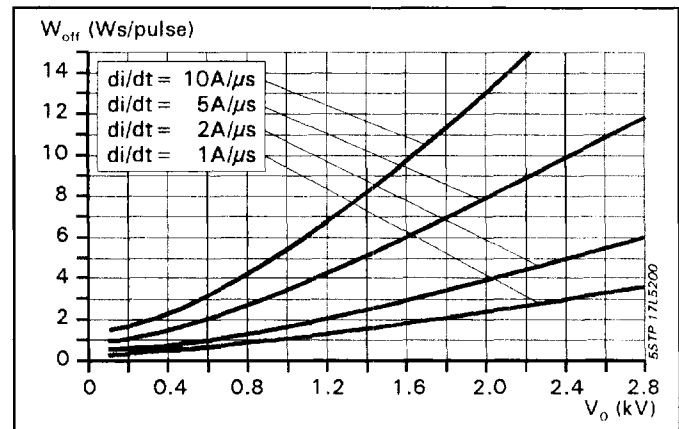

Fig.18 $W_{off} = f(V_o, di/dt)$, $T_{vj} = 125^\circ\text{C}$. Rectangular waves.

