

### PHASE CONTROL THYRISTORS

### Hockey Puk Version

#### Features

- Center amplifying gate
- Metal case with ceramic insulator
- International standard case TO-200AC (B-PUK)

#### Typical Applications

- DC motor control
- Controlled DC power supplies
- AC controllers

#### Major Ratings and Characteristics

Parameters	ST650C..L	Units
$I_{T(AV)}$	790	A
	@ $T_{hs}$	55 °C
$I_{T(RMS)}$	1557	A
	@ $T_{hs}$	25 °C
$I_{TSM}$	@ 50Hz	10100 A
	@ 60Hz	10700 A
$I^2t$	@ 50Hz	510 KA <sup>2</sup> s
	@ 60Hz	475 KA <sup>2</sup> s
$V_{DRM}/V_{RRM}$	2000 to 2400	V
$t_q$ typical	200	μs
$T_J$	- 40 to 125	°C

790A

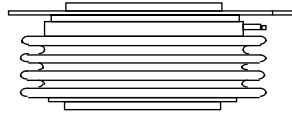

case style TO-200AC (B-PUK)

## ST650C..L Series

Bulletin I25203 rev. B 04/00

International  
IOR Rectifier

### ELECTRICAL SPECIFICATIONS

#### Voltage Ratings

Type number	Voltage Code	$V_{DRM}/V_{RRM}$ , max. repetitive peak and off-state voltage V	$V_{RSM}$ , maximum non-repetitive peak voltage V	$I_{DRM}/I_{RRM}$ max. @ $T_J = T_J$ max mA
ST650C..L	20	2000	2100	80
	22	2200	2300	
	24	2400	2500	

#### On-state Conduction

Parameter	ST650C..L	Units	Conditions	
$I_{T(AV)}$ Max. average on-state current @ Heatsink temperature	790 (324)	A	180° conduction, half sine wave double side (single side) cooled	
	55 (85)	°C		
$I_{T(RMS)}$ Max. RMS on-state current	1857	A	DC @ 25°C heatsink temperature double side cooled	
$I_{TSM}$ Max. peak, one-cycle non-repetitive surge current	10100		t = 10ms	No voltage reappplied
	10700		t = 8.3ms	reappplied
	8600		t = 10ms	100% $V_{RRM}$
$I^2t$ Maximum $I^2t$ for fusing	9150	t = 8.3ms	reappplied	
	510	t = 10ms	No voltage reappplied	
		t = 8.3ms	reappplied	
	475	t = 10ms	100% $V_{RRM}$	
370	t = 8.3ms	reappplied		
347				
$I^2\sqrt{t}$ Maximum $I^2\sqrt{t}$ for fusing	5100	$KA^2\sqrt{s}$	t = 0.1 to 10ms, no voltage reappplied	
$V_{T(TO)1}$ Low level value of threshold voltage	1.04	V	$(16.7\% \times \pi \times I_{T(AV)} < I < \pi \times I_{T(AV)})$ , $T_J = T_J$ max.	
$V_{T(TO)2}$ High level value of threshold voltage	1.13		$(I > \pi \times I_{T(AV)})$ , $T_J = T_J$ max.	
$r_{t1}$ Low level value of on-state slope resistance	0.61	mΩ	$(16.7\% \times \pi \times I_{T(AV)} < I < \pi \times I_{T(AV)})$ , $T_J = T_J$ max.	
$r_{t2}$ High level value of on-state slope resistance	0.35		$(I > \pi \times I_{T(AV)})$ , $T_J = T_J$ max.	
$V_{TM}$ Max. on-state voltage	2.07	V	$I_{pk} = 1700A$ , $T_J = T_J$ max, $t_p = 10ms$ sine pulse	
$I_H$ Maximum holding current	600	mA	$T_J = 25^\circ C$ , anode supply 12V resistive load	
$I_L$ Typical latching current	1000			

**Switching**

Parameter	ST650C..L	Units	Conditions
di/dt Max. non-repetitive rate of rise of turned-on current	1000	A/μs	Gate drive 20V, 20Ω, t <sub>r</sub> ≤ 1μs T <sub>J</sub> = T <sub>J</sub> max, anode voltage ≤ 80% V <sub>DRM</sub>
t <sub>d</sub> Typical delay time	1.0	μs	Gate current 1A, di <sub>g</sub> /dt = 1A/μs V <sub>d</sub> = 0.67% V <sub>DRM</sub> , T <sub>J</sub> = 25°C
t <sub>q</sub> Typical turn-off time	200		I <sub>TM</sub> = 750A, T <sub>J</sub> = T <sub>J</sub> max, di/dt = 60A/μs, V <sub>R</sub> = 50V dv/dt = 20V/μs, Gate 0V 100Ω, t <sub>p</sub> = 500μs

**Blocking**

Parameter	ST650C..L	Units	Conditions
dv/dt Maximum critical rate of rise of off-state voltage	500	V/μs	T <sub>J</sub> = T <sub>J</sub> max. linear to 80% rated V <sub>DRM</sub>
I <sub>DRM</sub> I <sub>RRM</sub> Max. peak reverse and off-state leakage current	80	mA	T <sub>J</sub> = T <sub>J</sub> max, rated V <sub>DRM</sub> /V <sub>RRM</sub> applied

**Triggering**

Parameter	ST650C..L		Units	Conditions
P <sub>GM</sub> Maximum peak gate power	10.0		W	T <sub>J</sub> = T <sub>J</sub> max, t <sub>p</sub> ≤ 5ms
P <sub>G(AV)</sub> Maximum average gate power	2.0			T <sub>J</sub> = T <sub>J</sub> max, f = 50Hz, d% = 50
I <sub>GM</sub> Max. peak positive gate current	3.0		A	T <sub>J</sub> = T <sub>J</sub> max, t <sub>p</sub> ≤ 5ms
+V <sub>GM</sub> Maximum peak positive gate voltage	20		V	T <sub>J</sub> = T <sub>J</sub> max, t <sub>p</sub> ≤ 5ms
-V <sub>GM</sub> Maximum peak negative gate voltage	5.0			
I <sub>GT</sub> DC gate current required to trigger	TYP.	MAX.	mA	T <sub>J</sub> = - 40°C T <sub>J</sub> = 25°C T <sub>J</sub> = 125°C  Max. required gate trigger/ current/ voltage are the lowest value which will trigger all units 12V anode-to-cathode applied
	200	-		
	100	200		
V <sub>GT</sub> DC gate voltage required to trigger	2.5	-	V	T <sub>J</sub> = - 40°C T <sub>J</sub> = 25°C T <sub>J</sub> = 125°C
	1.8	3.0		
	1.1	-		
I <sub>GD</sub> DC gate current not to trigger	10		mA	Max. gate current/voltage not to trigger is the max. value which will not trigger any unit with rated V <sub>DRM</sub> anode-to-cathode applied
V <sub>GD</sub> DC gate voltage not to trigger	0.25		V	

## ST650C..L Series

Bulletin I25203 rev. B 04/00

International  
IRF Rectifier

### Thermal and Mechanical Specification

Parameter	ST650C..L	Units	Conditions
$T_J$ Max. operating temperature range	-40 to 125	°C	
$T_{stg}$ Max. storage temperature range	-40 to 150		
$R_{thJ-hs}$ Max. thermal resistance, junction to heatsink	0.073 0.031	K/W	DC operation single side cooled DC operation double side cooled
$R_{thC-hs}$ Max. thermal resistance, case to heatsink	0.011 0.006	K/W	DC operation single side cooled DC operation double side cooled
F Mounting force, $\pm 10\%$	14700 (1500)	N (Kg)	
wt Approximate weight	255	g	
Case style	TO-200AC (B-PUK)		See Outline Table

### $\Delta R_{thJ-hs}$ Conduction

(The following table shows the increment of thermal resistance  $R_{thJ-hs}$  when devices operate at different conduction angles than DC)

Conduction angle	Sinusoidal conduction		Rectangular conduction		Units	Conditions
	Single Side	Double Side	Single Side	Double Side		
180°	0.009	0.009	0.006	0.006	K/W	$T_J = T_J \text{ max.}$
120°	0.011	0.011	0.011	0.011		
90°	0.014	0.014	0.015	0.015		
60°	0.020	0.020	0.021	0.021		
30°	0.036	0.036	0.036	0.036		

### Ordering Information Table

Device Code							
ST	65	0	C	24	L	1	
①	②	③	④	⑤	⑥	⑦	⑧
<b>1</b>	- Thyristor	<b>2</b>	- Essential part number	<b>3</b>	- 0 = Converter grade	<b>4</b>	- C = Ceramic Puk
<b>5</b>	- Voltage code: Code x 100 = $V_{RRM}$ (See Voltage Rating Table)	<b>6</b>	- L = Puk Case TO-200AC (B-PUK)	<b>7</b>	- 0 = Eyelet terminals (Gate and Auxiliary Cathode Unsoldered Leads) 1 = Fast-on terminals (Gate and Auxiliary Cathode Unsoldered Leads) 2 = Eyelet terminals (Gate and Auxiliary Cathode Soldered Leads) 3 = Fast-on terminals (Gate and Auxiliary Cathode Soldered Leads)	<b>8</b>	- Critical dv/dt: None = 500V/ $\mu$ sec (Standard selection) L = 1000V/ $\mu$ sec (Special selection)

Outline Table

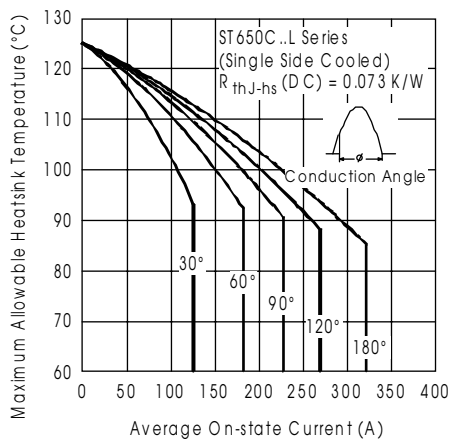
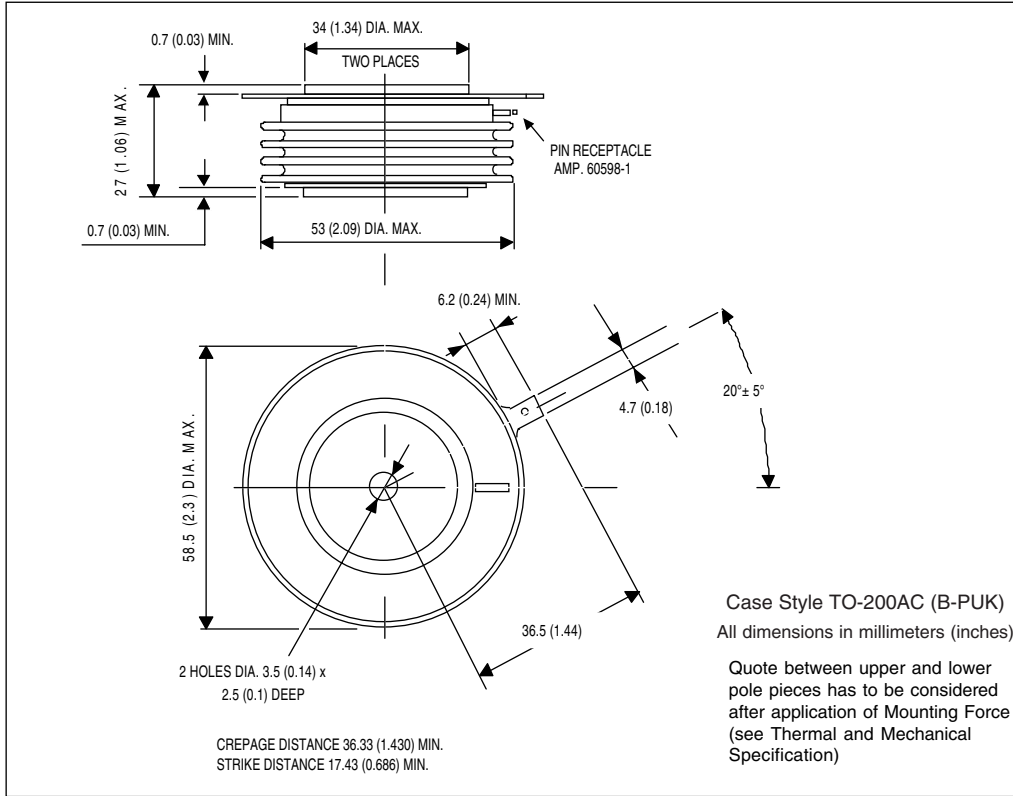

Fig. 1 - Current Ratings Characteristics

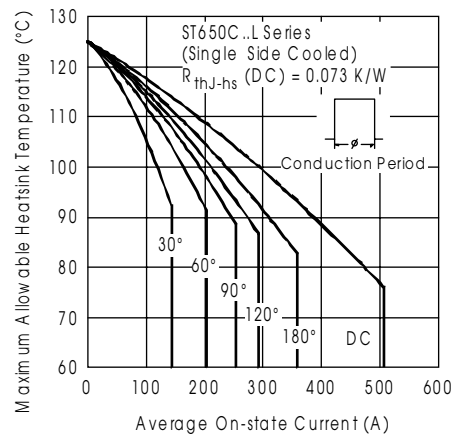

Fig. 2 - Current Ratings Characteristics

# ST650C..L Series

Bulletin I25203 rev. B 04/00

International  
**IRF** Rectifier

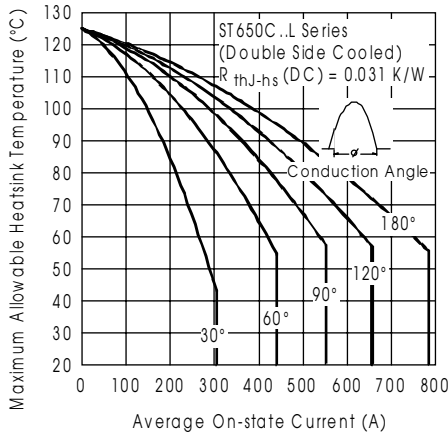

Fig. 3 - Current Ratings Characteristics

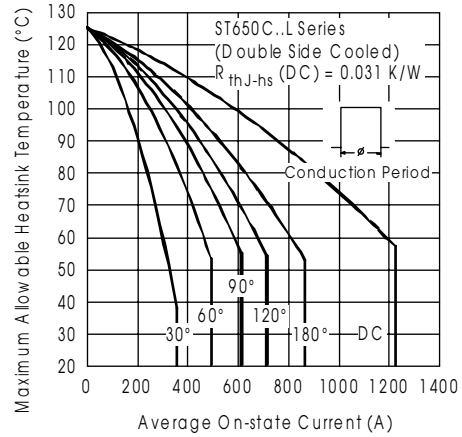

Fig. 4 - Current Ratings Characteristics

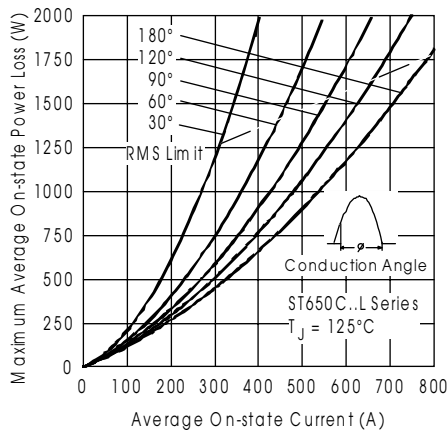

Fig. 5 - On-state Power Loss Characteristics

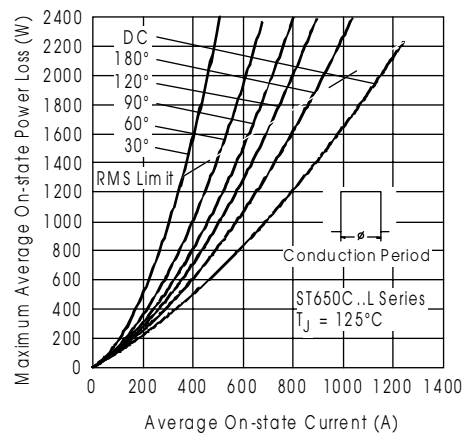

Fig. 6 - On-state Power Loss Characteristics

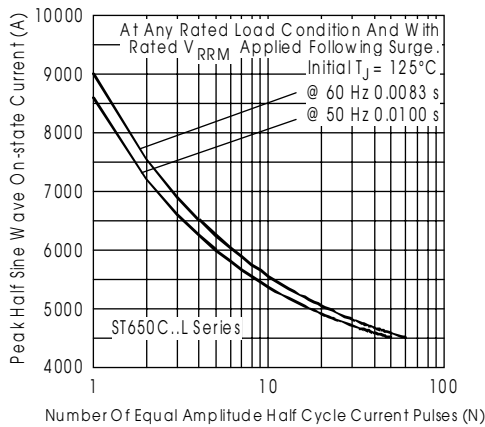

Fig. 7 - Maximum Non-Repetitive Surge Current Single and Double Side Cooled

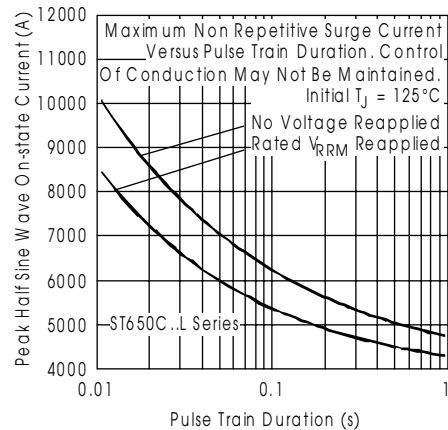

Fig. 8 - Maximum Non-Repetitive Surge Current Single and Double Side Cooled

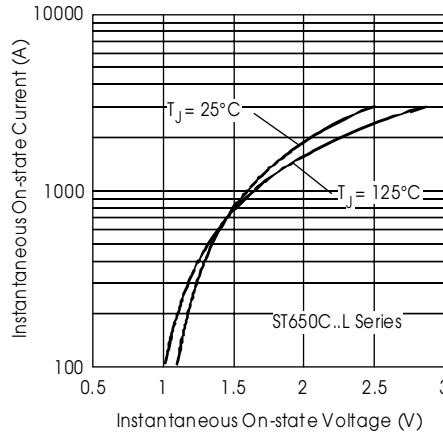

Fig. 9 - On-state Voltage Drop Characteristics

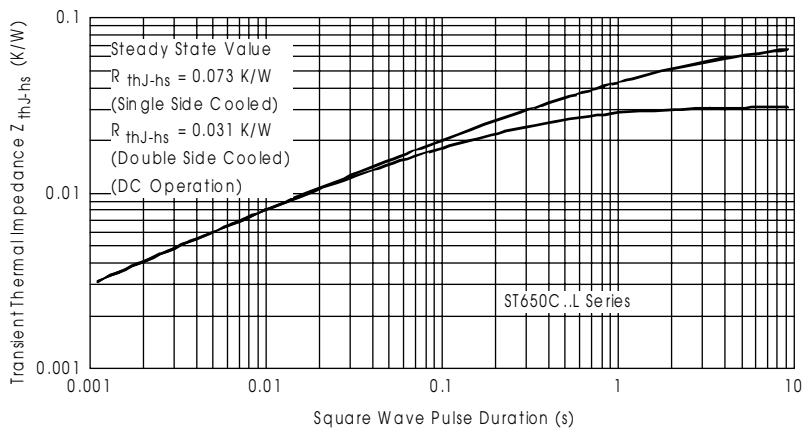

Fig. 10 - Thermal Impedance  $Z_{thJ-hs}$  Characteristics

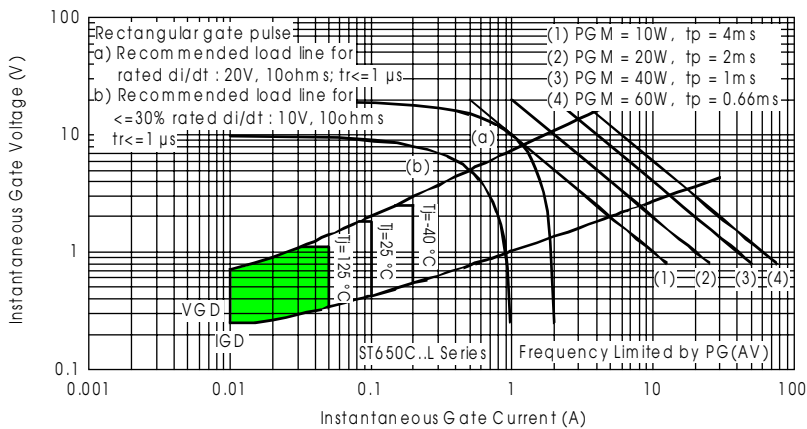

Fig. 11 - Gate Characteristics