

**SERIES:** NEB-D | **DESCRIPTION:** FULLY REGULATED ADVANCED BUS CONVERTERS

**GENERAL CHARACTERISTICS**

- configurable soft start/stop
- precision delay and ramp-up
- voltage margining
- voltage/current/temperature monitoring
- configurable output voltage
- configurable fault response
- power good

**FEATURES**

- eighth-brick with digital PMBus interface  
58.4 x 22.7 x 10.2 mm  
(2.299 x 0.894 x 0.402 in)
- industry standard 5-pins for intermediate bus architectures
- industry-leading power density for telecom and datacom 129~147W / sq. in
- high efficiency, typ. 95.2% at half load, 12 Vout
- fully regulated advanced bus converter from 36~75Vin
- 2,250 Vdc input to output isolation
- fast feed forward regulation to manage line transients
- optional baseplate for high temperature applications
- droop load sharing with 10% current share accuracy
- PMBus Revision 1.2 compliant
- 2.9 million hours MTBF
- ISO 9001/14001 certified supplier
- Ericsson BMR454 & BMR457 compatible



**novum**  
advanced power



MODEL	input voltage	output voltage	output current	output wattage
	(Vdc)	(Vdc)	max (A)	max (W)
NEB-264DWA-AN	36~75	12	22	264
NEB-300DMA-AN	40~60	12	25	300
NEB-261DWB-AN	36~75	12.45	22	261

## PART NUMBER KEY

### NEB-XXX DXX - XXXX - XXX - ESX

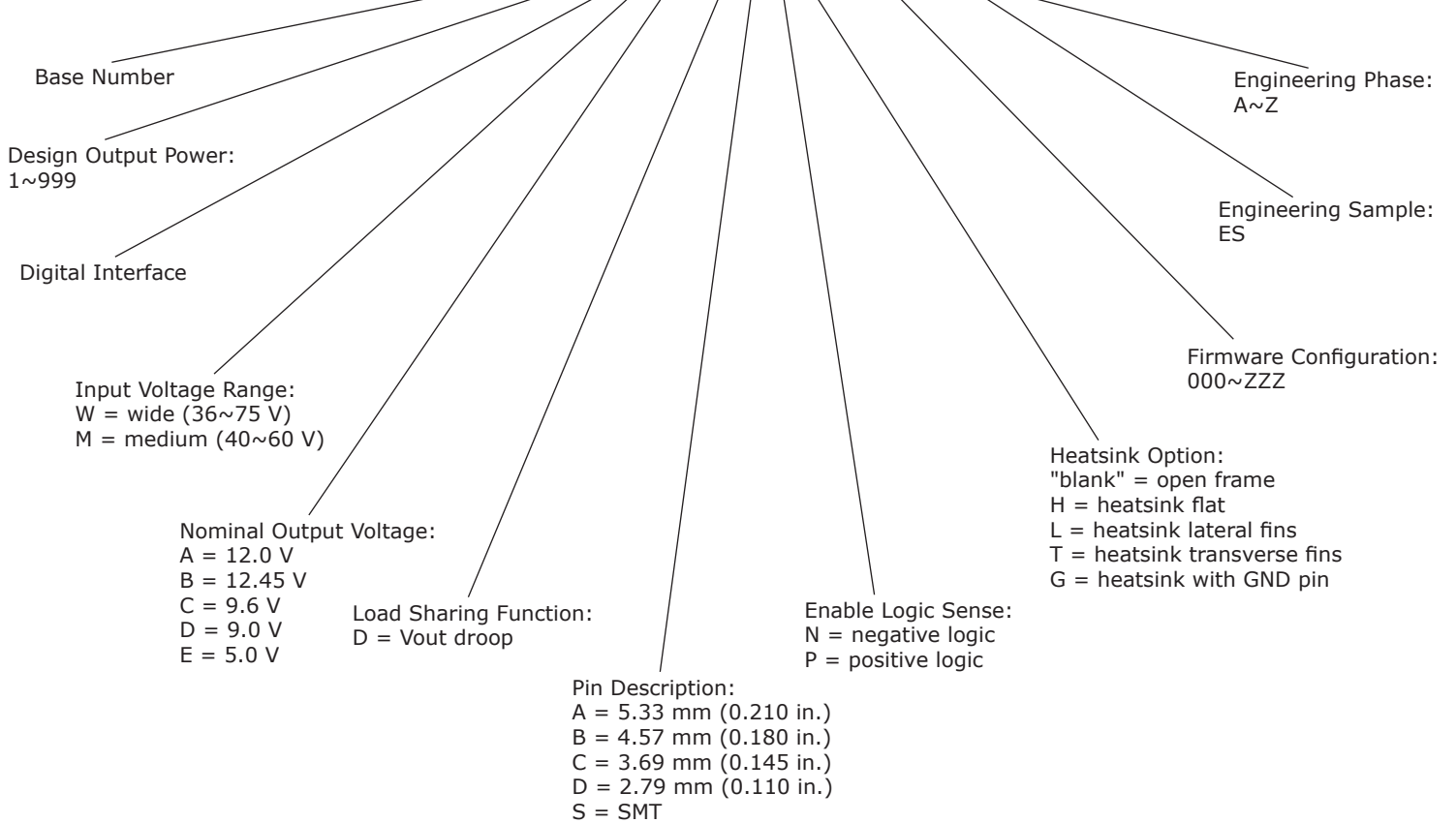

**Packaging:**

20 converters(through hole pin)/tray, PE foam dissipative  
 20 converters(surface mount pin)/tray, Antistatic PPE

Example part number: **NEB-264DWA-AN-001**

264 W output power, digital pins  
 wide input voltage range, 12.0 V output  
 5.33 mm pins, negative enable logic  
 firmware revision 001

## CONTENTS

Part Number Key.....	2	EMC Specification.....	20
General Information.....	3	Operating Information.....	21
Safety Specification.....	3	Thermal Consideration.....	24
Absolute Maximum Ratings.....	4	Connections.....	25
Electrical Specification:		PMBus Interface.....	26
12V, 22A, 264W, 36~75Vin; NEB-264DWA-AN.....	6	Mechanical Information.....	29
12V, 25A, 300W, 40~60Vin; NEB-300DMA-AN.....	10	Soldering Information.....	32
12.45V, 22A, 261W, 36~75Vin; NEB-261DWB-AN.....	14	Delivery Package Information.....	33
12.45V, 25A, 296W, 40~60Vin; NEB-296DMB-AN.....	17	Product Qualification Specification.....	35

## General Information

### Reliability

The failure rate ( $\lambda$ ) and mean time between failures (MTBF =  $1/\lambda$ ) is calculated at max output power and an operating ambient temperature ( $T_A$ ) of +40°C. CUI Power Modules uses Telcordia SR-332 Issue 2 Method 1 to calculate the mean steady-state failure rate and standard deviation ( $\sigma$ ).

Telcordia SR-332 Issue 2 also provides techniques to estimate the upper confidence levels of failure rates based on the mean and standard deviation.

Mean steady-state failure rate, $\lambda$	Std. deviation, $\sigma$
421 n Failures/h	60.9 n Failures/h

MTBF (mean value) for the NEB series = 2.91 Mh.  
MTBF at 90% confidence level = 2.37 Mh

### Compatibility with RoHS requirements

The products are compatible with the relevant clauses and requirements of the RoHS directive 2011/65/EU and have a maximum concentration value of 0.1% by weight in homogeneous materials for lead, mercury, hexavalent chromium, PBB and PBDE and of 0.01% by weight in homogeneous materials for cadmium.

Exemptions in the RoHS directive utilized in CUI Power Modules products are found in the Statement of Compliance document.

## Safety Specification

### General Information

CUI Power Modules DC/DC converters and DC/DC regulators are designed in accordance with the safety standards IEC60950-1, EN60950-1 and UL60950-1 Safety of Information Technology Equipment

IEC/EN/UL60950-1 contains requirements to prevent injury or damage due to the following hazards:

- Electrical Shock
- Energy hazards
- Fire
- Mechanical and heat hazards
- Radiation hazards
- Chemical hazards

On-board DC/DC converters and DC/DC regulators are defined as component power supplies. As components they cannot fully comply with the provisions of any safety requirements without "conditions of acceptability". Clearance between conductors and between conductive parts of the component power supply and conductors on the board in the final product must meet the applicable safety requirements. Certain conditions of acceptability apply for component power supplies with limited stand-off (see Mechanical Information for further information). It is

the responsibility of the installer to ensure that the final product housing these components complies with the requirements of all applicable safety standards and regulations for the final product.

Component power supplies for general use should comply with the requirements in IEC/EN/UL 60950 1 Safety of Information Technology Equipment. Product related standards, e.g. IEEE 802.3af Power over Ethernet, and ETS 300132 2 Power interface at the input to telecom equipment, operated by direct current (dc) are based on IEC/EN/UL 60950 1 with regards to safety.

CUI Power Modules DC/DC converters and DC/DC regulators are UL 60950-1 recognized and certified in accordance with EN 60950-1. The flammability rating for all construction parts of the products meet requirements for V-0 class material according to IEC 60695-11-10, Fire hazard testing, test flames – 50 W horizontal and vertical flame test methods.

### Isolated DC/DC converters

Galvanic isolation between input and output is verified in an electric strength test and the isolation voltage ( $V_{iso}$ ) meets the voltage strength requirement for basic insulation according to IEC/EN/UL 60950-1.

It is recommended to use a slow blow fuse at the input of each DC/DC converter. If an input filter is used in the circuit the fuse should be placed in front of the input filter. In the rare event of a component problem that imposes a short circuit on the input source, this fuse will provide the following functions:

- Isolate the fault from the input power source so as not to affect the operation of other parts of the system
- Protect the distribution wiring from excessive current and power loss thus preventing hazardous overheating

The DC/DC converter output is considered as safety extra low voltage (SELV) if one of the following conditions is met:

- The input source has double or reinforced insulation from the AC mains according to IEC/EN/UL 60950-1
- The input source has basic or supplementary insulation from the AC mains and the input of the DC/DC converter is maximum 60 Vdc and connected to protective earth according to IEC/EN/UL 60950-1
- The input source has basic or supplementary insulation from the AC mains and the DC/DC converter output is connected to protective earth according to IEC/EN/UL 60950-1

### Non - isolated DC/DC regulators

The DC/DC regulator output is SELV if the input source meets the requirements for SELV circuits according to IEC/EN/UL 60950-1.

## Absolute Maximum Ratings

parameter	conditions/description	min	typ	max	units
operating temperature ( $T_{p1}$ )	see thermal consideration section	-40		+125	°C
storage temperature ( $T_s$ )		-55		+125	°C
input voltage ( $V_i$ )		-0.5		+80 +65*	V
isolation voltage ( $V_{iso}$ )	input to output test voltage, see note 1			2250	Vdc
input voltage transient ( $V_{tr}$ )	according to ETSI EN 300 132-2 and Telcordia GR-1089-CORE			+100 +80*	V
remote control pin voltage ( $V_{RC}$ )	see operating information section	-0.3		18	V
SALERT, CTRL, SCL, SDA, SA0, SA1 (V Logic I/O)		-0.3		3.6	V

Stress in excess of Absolute Maximum Ratings may cause permanent damage. Absolute Maximum Ratings, sometimes referred to as no destruction limits, are normally tested with one parameter at a time exceeding the limits in the Electrical Specification. If exposed to stress above these limits, function and performance may degrade in an unspecified manner.

Note 1: Isolation voltage (input/output to base-plate) max 750 Vdc.

\* Applies for the narrow input version  $V_i = 40-60$  V

## Fundamental Circuit Diagram

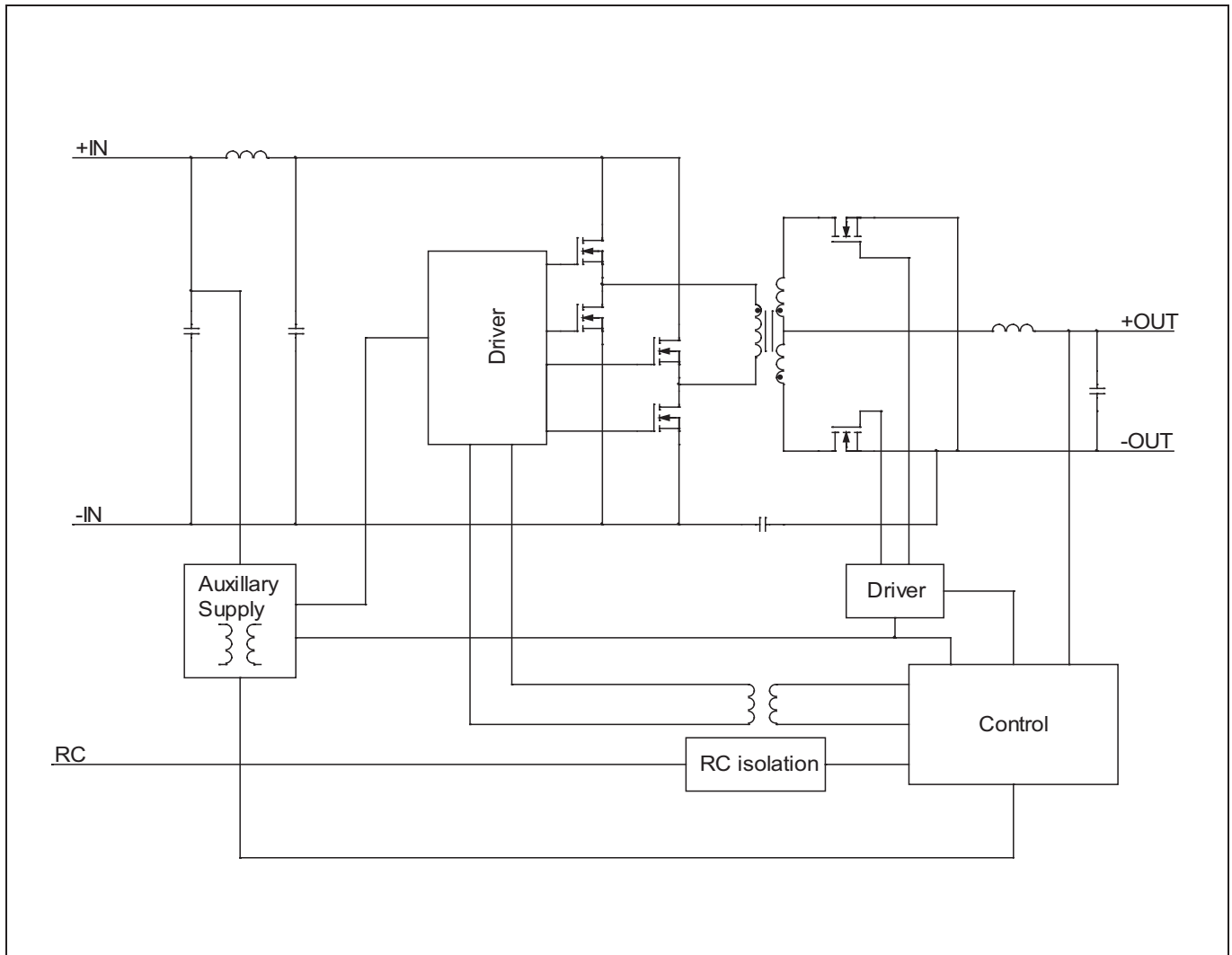

## Functional Description

$T_{P1}, T_{P3} = -40$  to  $+90^{\circ}\text{C}$ ,  $V_I = 36$  to  $75$  V, sense pins connected to output pins unless otherwise specified under Conditions.  
 Typical values given at:  $T_{P1}, T_{P3} = +25^{\circ}\text{C}$ ,  $V_I = 53$  V, max  $I_O$ , unless otherwise specified under Conditions  
 Configuration File: 190 10-CDA 102 0315/001

parameter	conditions/description	min	typ	max	units
<b>PMBus monitoring accuracy</b>					
input voltage (VIN_READ)		-2	$\pm 0.5$	2	%
output voltage (VOUT_READ)	$V_I = 53\text{V}$	-1.0	$\pm 0.1$	1.0	%
output current (IOUT_READ)	$V_I = 53\text{V}$ , 50-100% of max $I_O$ $V_I = 53\text{V}$ , 10% of max $I_O$	-6 -0.6	$\pm 0.15$	6 0.6	% A
temperature (TEMP_READ)	controller IC internal sensor	0	5	10	$^{\circ}\text{C}$
<b>fault protection characteristics</b>					
input under voltage lockout (UVLO)	factory default		32		V
	setpoint accuracy	0	0.5	1	V
	hysteresis: factory default		2		V
	hysteresis: configurable via PMBus of threshold range, note 1	0			V
	delay		300		$\mu\text{s}$
output voltage - under voltage protection (VOUT_UV_FAULT_LIMIT)	factory default		0		V
	configurable via PMBus, note 1	0		16	V
	fault response time		200		$\mu\text{s}$
output voltage - over voltage protection (VOUT_OV_FAULT_LIMIT)	factory default		15.6		V
	configurable via PMBus, note 1	$V_{\text{OUT}}$		16	V
	fault response time		200		$\mu\text{s}$
over current protection (OCP)	setpoint accuracy ( $I_O$ )	-6		6	%
	IOUT_OC_FAULT_LIMIT: factory default		25		A
	IOUT_OC_FAULT_LIMIT: configurable via PMBus, note 1	0		100	A
	fault response time		200		$\mu\text{s}$
over temperature protection (OTP)	OTP_FAULT_LIMIT: factory default		125		$^{\circ}\text{C}$
	OTP_FAULT_LIMIT: configurable via PMBus, note 1	-50		125	$^{\circ}\text{C}$
	hysteresis: factory default		10		$^{\circ}\text{C}$
	hysteresis: configurable via PMBus, note 1	0		125	$^{\circ}\text{C}$
	fault response time		300		$\mu\text{s}$
<b>logic input/output characteristics</b>					
logic input low ( $V_{\text{IL}}$ )	CTRL, SA0, SA1, PG, SCL, SDA			1.1	V
logic input high ( $V_{\text{IH}}$ )	CTRL, SA0, SA1, PG, SCL, SDA	2.1			V
logic output low ( $V_{\text{OL}}$ )	CTRL, PG, SALERT, SCL, SDA $I_{\text{OL}} = 6$ mA			0.25	V
logic output high ( $V_{\text{OH}}$ )	CTRL, PG, SALERT, SCL, SDA $I_{\text{OH}} = -6$ mA	2.7			V
bus free time T(BUF)	note 2	1.3			$\mu\text{s}$

Note 1: See Operating Information section.

Note 2: PMBus timing parameters according to PMBus spec.

## Electrical Specification

### 12 V, 22 A, 264 W

$T_{p1} = -40$  to  $+90^{\circ}\text{C}$ ,  $V_I = 36$  to  $75\text{V}$ , sense pins connected to output pins unless otherwise specified under Conditions.

Typical values given at:  $T_{p1} = +25^{\circ}\text{C}$ ,  $V_I = 53\text{V}$ , max  $I_{O}$ , unless otherwise specified under Conditions.

Additional  $C_{in} = 0.1\text{mF}$ ,  $C_{out} = 0.1\text{mF}$ . See Operating Information section for selection of capacitor types.

Configuration File: 19010-CDA 102 0315/001

parameter	conditions/description	min	typ	max	units
input voltage range ( $V_I$ )		36		75	V
turn-off input voltage ( $V_{Ioff}$ )	decreasing input voltage	32	33	34	V
turn-on input voltage ( $V_{Ion}$ )	increasing input voltage	34	35	36	V
internal input capacitance ( $C_I$ )			11		$\mu\text{F}$
output power ( $P_O$ )		0		264	W
efficiency ( $\eta$ )	50% of max $I_O$		94.7		%
	max $I_O$		94.5		%
	50% of max $I_O$ , $V_I = 48\text{V}$		95.2		%
	max $I_O$ , $V_I = 48\text{V}$		94.8		%
power dissipation ( $P_d$ )	max $I_O$		15.5	22	W
input idling power ( $P_{ii}$ )	$I_O = 0\text{A}$ , $V_I = 53\text{V}$		3.5		W
input standby power ( $P_{RC}$ )	$V_I = 53\text{V}$ (turned off with RC)		0.4		W
default switching frequency ( $f_s$ )	0-100% of max $I_O$	171	180	189	kHz
output voltage initial setting and accuracy ( $V_{O1}$ )	$T_{p1} = +25^{\circ}\text{C}$ , $V_I = 53\text{V}$ , $I_O = 12\text{A}$	11.88	12.0	12.12	V
output adjust range ( $V_O$ )	see operating information	6.9		13.2	V
output voltage tolerance band ( $V_O$ )	0-100% of max $I_O$	11.76		12.24	V
idling voltage ( $V_O$ )	$I_O = 0\text{A}$	11.88		12.12	V
line regulation ( $V_O$ )	max $I_O$		100	200	mV
load regulation ( $V_O$ )	$V_I = 53\text{V}$ , 1-100% of max $I_O$		30	100	mV
load transient voltage deviation ( $V_{tr}$ )	$V_I = 53\text{V}$ , load step 25-75-25% of max $I_O$ , $di/dt = 1\text{A}/\mu\text{s}$ , $C_{out} = 2.2\text{mF}$ OSCON type		$\pm 350$		mV
load transient recovery time ( $t_{tr}$ )	$V_I = 53\text{V}$ , load step 25-75-25% of max $I_O$ , $di/dt = 1\text{A}/\mu\text{s}$ , $C_{out} = 2.2\text{mF}$ OSCON type		200		$\mu\text{s}$
ramp-up time ( $t_r$ ) - (from 10-90% of $V_{O1}$ )	10-100% of max $I_O$		8		ms
start-up time ( $t_s$ ) - (from $V_I$ connection to 90% of $V_{O1}$ )	10-100% of max $I_O$		23		ms
$V_I$ shut-down fall time ( $t_f$ ) - (from $V_I$ off to 10% of $V_O$ )	max $I_O$		0.7		ms
	$I_O = 0\text{A}$		6		s
RC start-up time ( $t_{RC}$ )	max $I_O$		12		ms
RC shut-down fall time ( $t_{RC}$ ) - (from RC off to 10% of $V_O$ )	max $I_O$		3		ms
	$I_O = 0\text{A}$		6		s
output current ( $I_O$ )		0		22	A
current limit threshold ( $I_{lim}$ )	$V_O = 10.8\text{V}$ , $T_{p1} < \text{max } T_{p1}$	24	25	26	A
short circuit current ( $I_{sc}$ )	$T_{p1} = 25^{\circ}\text{C}$ , see Note 1		1.1		A
recommended capacitive load ( $C_{out}$ )	$T_{p1} = 25^{\circ}\text{C}$ , see Note 2	0	2.2	6	mF
output ripple & noise ( $V_{Oac}$ )	See ripple & noise section, $V_{O1}$		50	100	mVp-p
over voltage protection (OVP)	$T_{p1} = +25^{\circ}\text{C}$ , $V_I = 53\text{V}$ , 10-100 % of max $I_O$		15.6		V
remote control (RC)	sink current (note 3), see operating information			0.7	mA
	trigger level, decreasing RC-voltage		2.6		V
	trigger level, increasing RC-voltage		2.9		V

Note 1: OCP in hic-up mode

2: Low ESR-value

3: Sink current drawn by external device connected to the RC pin. Minimum sink current required to guarantee activated RC function.

**Typical Characteristics**

**12 V, 22 A, 264 W**

**Efficiency**

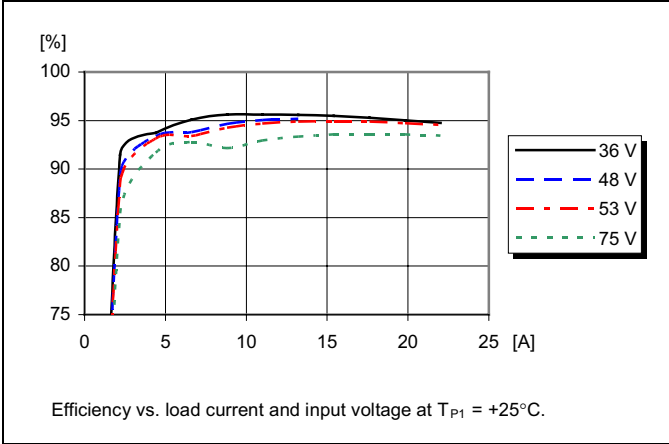

**Power Dissipation**

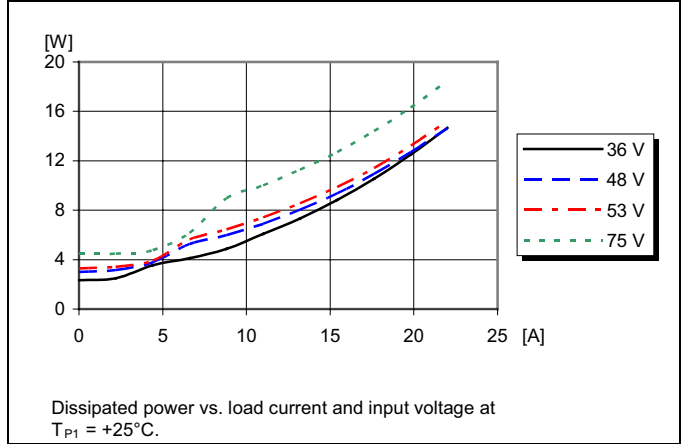

**Output Characteristics**

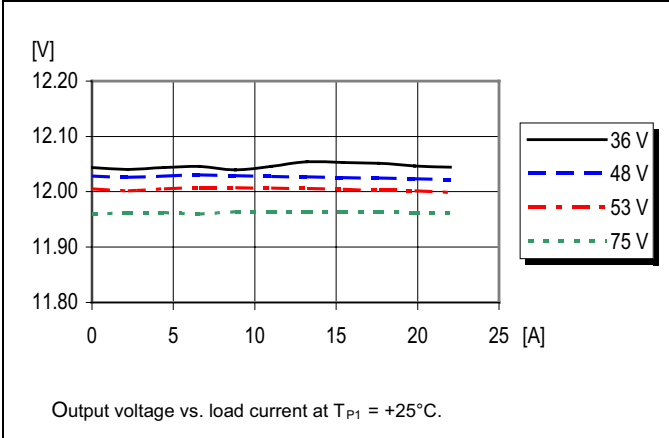

**Current Limit Characteristics**

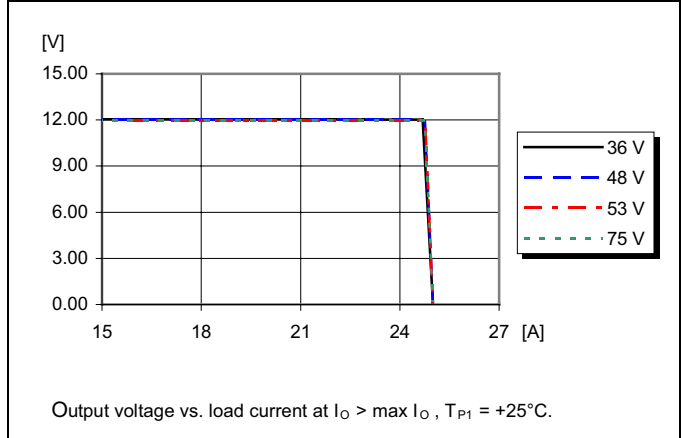

**Typical Characteristics**  
**12 V, 22 A, 264 W**

**Start-up**

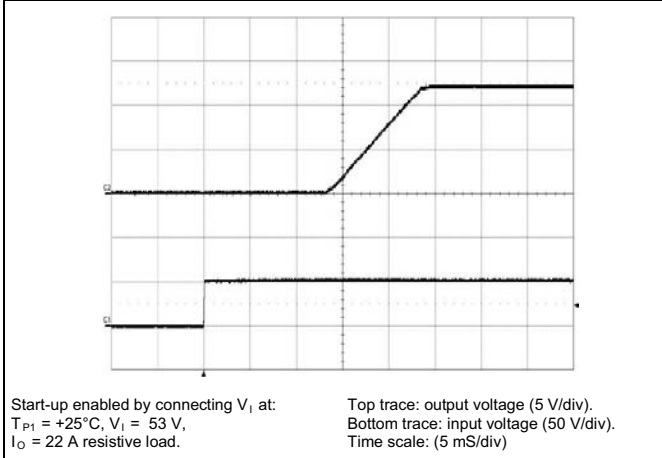

**Shut-down**

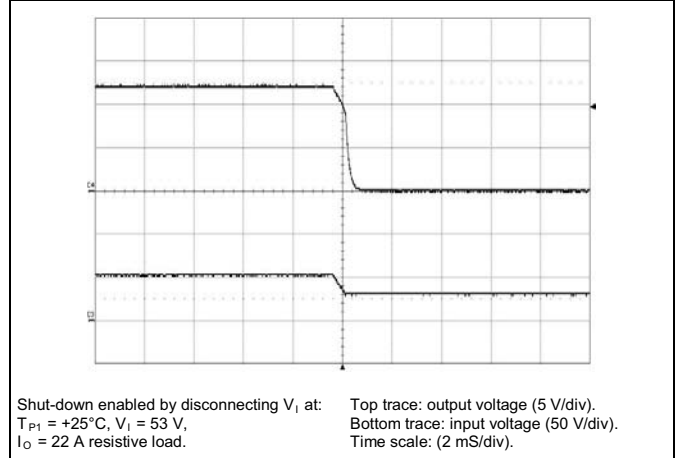

**Output Ripple & Noise**

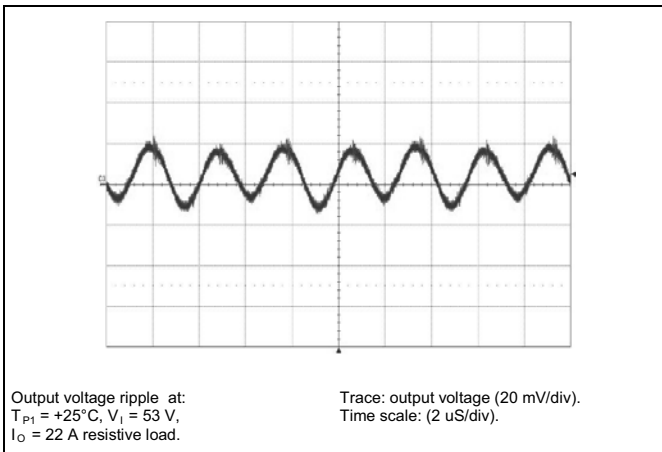

**Output Load Transient Response**

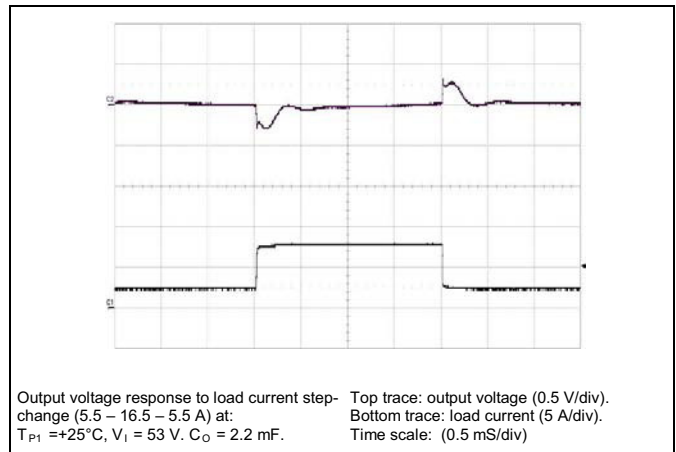

**Input Voltage Transient Response**

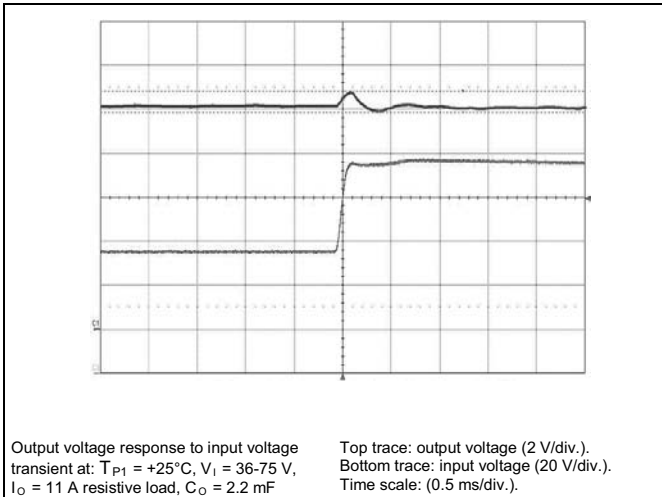



**Typical Characteristics**  
**12 V, 22 A, 264 W**

**Output Current Derating – Open frame**

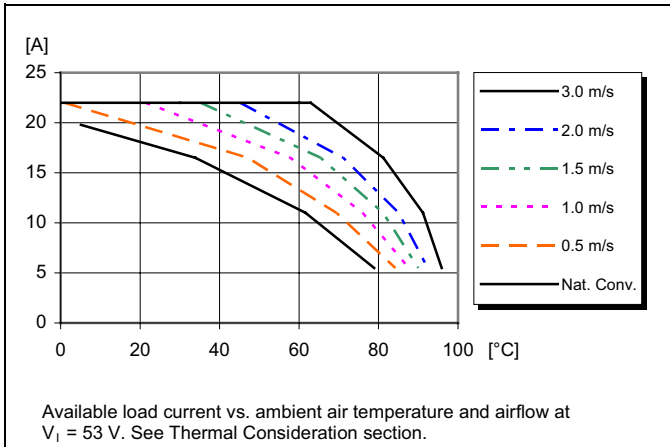

**Output Current Derating – Base plate**

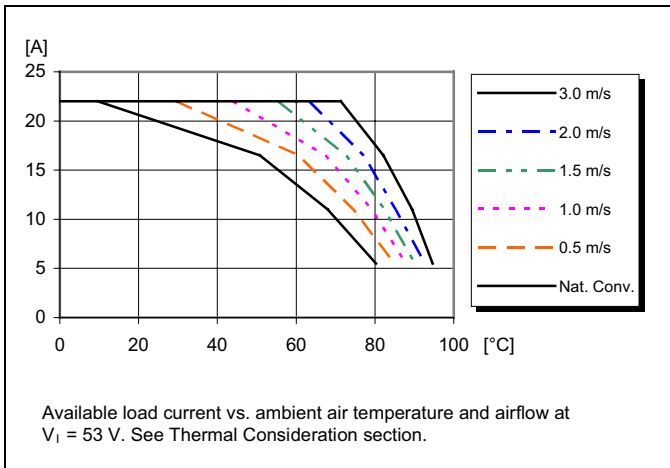

**Thermal Resistance – Base plate**

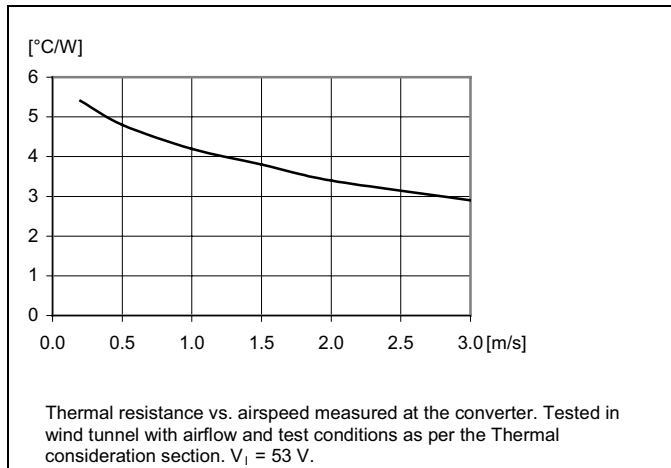

**Output Current Derating – Base plate + Heat sink**

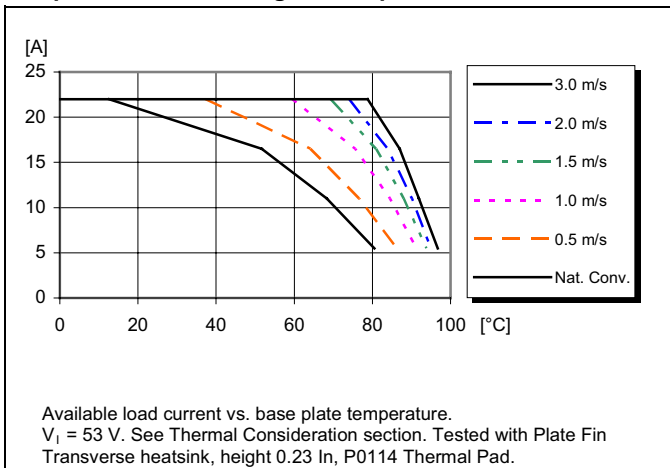

**Output Current Derating – Cold wall sealed box**

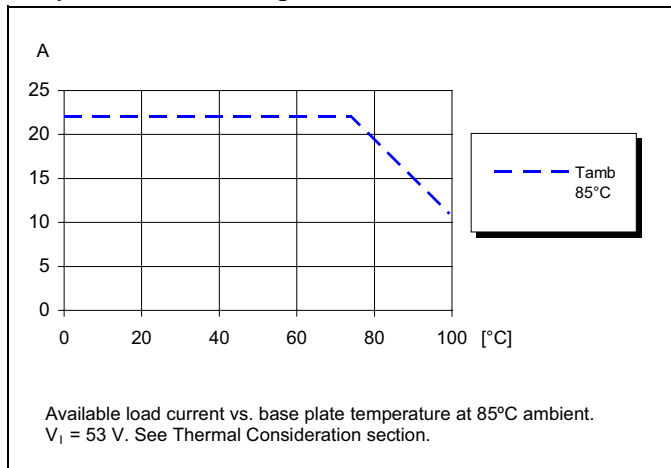

## Electrical Specification

### 12 V, 25 A, 300 W

$T_{P1} = -40$  to  $+90^{\circ}\text{C}$ ,  $V_I = 40$  to  $60$  V, sense pins connected to output pins unless otherwise specified under Conditions.

Typical values given at:  $T_{P1} = +25^{\circ}\text{C}$ ,  $V_I = 53$  V,  $I_O = \text{max}$ , unless otherwise specified under Conditions.

Additional  $C_{\text{out}} = 0.1$  mF. See Operating Information section for selection of capacitor types.

Configuration File: 19010-CDA1020315/002

parameter	conditions/description	min	typ	max	units
input voltage range ( $V_I$ )		40		60	V
turn-off input voltage ( $V_{\text{Ioff}}$ )	decreasing input voltage	36	37	38	V
turn-on input voltage ( $V_{\text{Ion}}$ )	increasing input voltage	38	39	40	V
internal input capacitance ( $C_I$ )			11		$\mu\text{F}$
output power ( $P_O$ )		0		300	W
efficiency ( $\eta$ )	50% of max $I_O$		95.2		%
	max $I_O$		94.6		%
	50% of max $I_O$ , $V_I = 48$ V		95.1		%
	max $I_O$ , $V_I = 48$ V		94.5		%
power dissipation ( $P_d$ )	max $I_O$		17	24	W
input idling power ( $P_{\text{I}}$ )	$I_O = 0$ A, $V_I = 53$ V		4.4		W
input standby power ( $P_{\text{RC}}$ )	$V_I = 53$ V (turned off with RC)		0.4		W
default switching frequency ( $f_s$ )	0-100% of max $I_O$		180		kHz
output voltage initial setting and accuracy ( $V_{\text{Oi}}$ )	$T_{P1} = +25^{\circ}\text{C}$ , $V_I = 53$ V, $I_O = 12$ A	11.88	12.0	12.12	V
output adjust range ( $V_O$ )	see operating information	6.9		13.2	V
output voltage tolerance band ( $V_O$ )	0-100% of max $I_O$	11.76		12.24	V
idling voltage ( $V_O$ )	$I_O = 0$ A	11.88		12.12	V
line regulation ( $V_O$ )	max $I_O$		50	220	mV
load regulation ( $V_O$ )	$V_I = 53$ V, 1-100% of max $I_O$		45	100	mV
load transient voltage deviation ( $V_{\text{tr}}$ )	$V_I = 53$ V, load step 25-75-25% of max $I_O$ , $di/dt = 1$ A/ $\mu\text{s}$ , $C_{\text{out}} = 2.5$ mF OSCON type		$\pm 300$		mV
load transient recovery time ( $t_{\text{tr}}$ )	$V_I = 53$ V, load step 25-75-25% of max $I_O$ , $di/dt = 1$ A/ $\mu\text{s}$ , $C_{\text{out}} = 2.5$ mF OSCON type		250		$\mu\text{s}$
ramp-up time ( $t_r$ ) - (from 10-90% of $V_{\text{Oi}}$ )	10-100% of max $I_O$		8		ms
start-up time ( $t_s$ ) - (from $V_I$ connection to 90% of $V_{\text{Oi}}$ )	10-100% of max $I_O$		23		ms
$V_I$ shut-down fall time ( $t_f$ ) - (from $V_I$ off to 10% of $V_O$ )	max $I_O$		0.7		ms
	$I_O = 0$ A		6		s
RC start-up time ( $t_{\text{RC}}$ )	max $I_O$		14		ms
RC shut-down fall time ( $t_{\text{RC}}$ ) - (from RC off to 10% of $V_O$ )	max $I_O$		4		ms
	$I_O = 0$ A		6		s
output current ( $I_O$ )		0		25	A
current limit threshold ( $I_{\text{lim}}$ )	$T_{P1} < \text{max } T_{P1}$	27	30	33	A
short circuit current ( $I_{\text{sc}}$ )	$T_{P1} = 25^{\circ}\text{C}$ , see Note 1		1.1		A
recommended capacitive load ( $C_{\text{out}}$ )	$T_{P1} = 25^{\circ}\text{C}$ , see Note 2	0	2.5	10	mF
output ripple & noise ( $V_{\text{Oac}}$ )	See ripple & noise section, $V_{\text{Oi}}$		70	140	mVp-p
over voltage protection (OVP)	$T_{P1} = +25^{\circ}\text{C}$ , $V_I = 53$ V, 10-100 % of max $I_O$		15.6		V
remote control (RC)	sink current (note 3), see operating information trigger level, decreasing RC-voltage trigger level, increasing RC-voltage			0.7	mA
			2.6		V
			2.9		V

Note 1: OCP in hic-cup mode  
 2: Low ESR-value  
 3: Sink current drawn by external device connected to the RC pin. Minimum sink current required to guarantee activated RC function.

**Typical Characteristics**

**12 V, 25 A, 300 W**

**Efficiency**

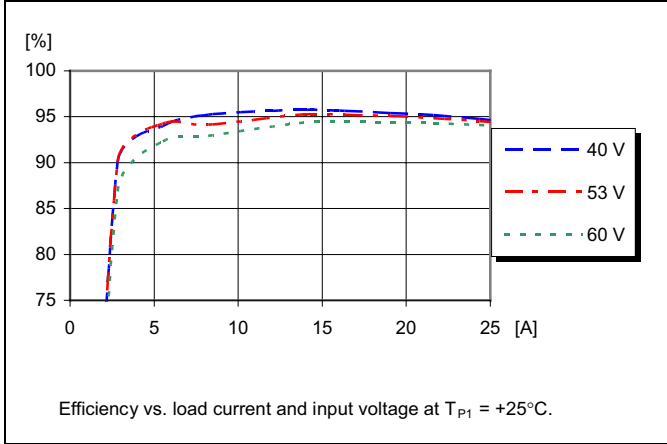

**Power Dissipation**

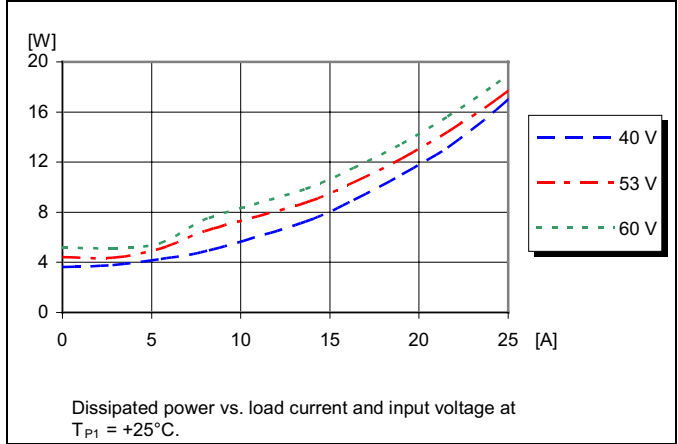

**Output Characteristics**

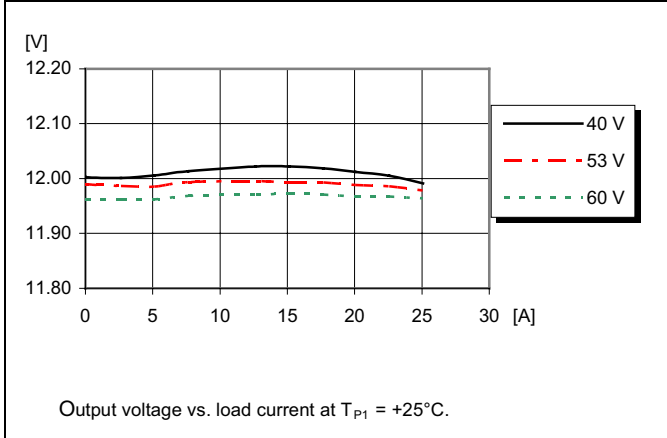

**Current Limit Characteristics**

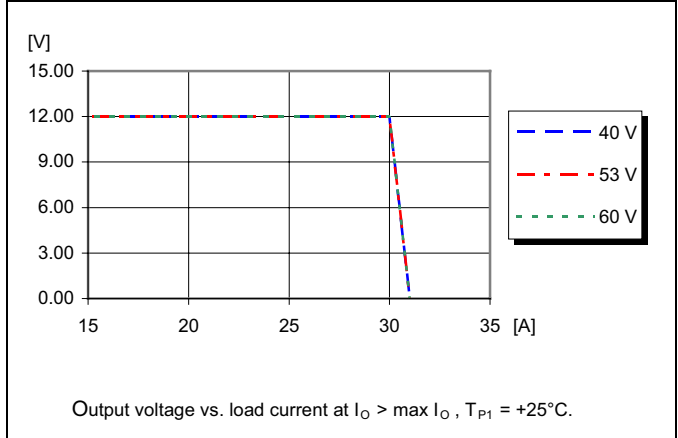

**Typical Characteristics**  
**12 V, 25 A, 300 W**

**Start-up**

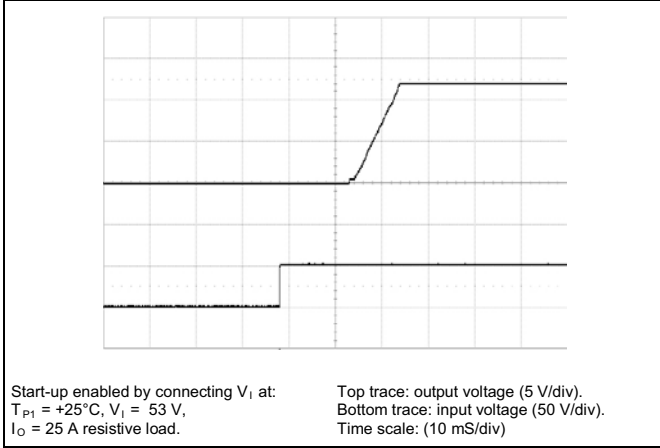

**Shut-down**

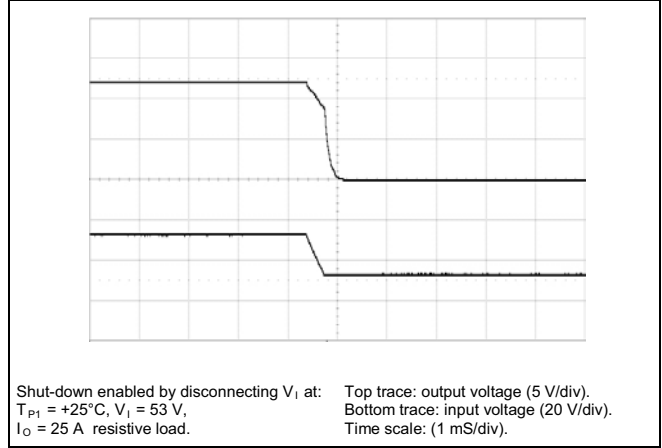

**Output Ripple & Noise**

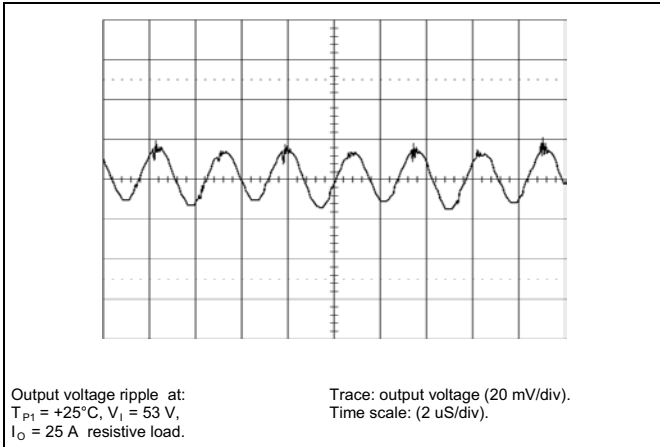

**Output Load Transient Response**

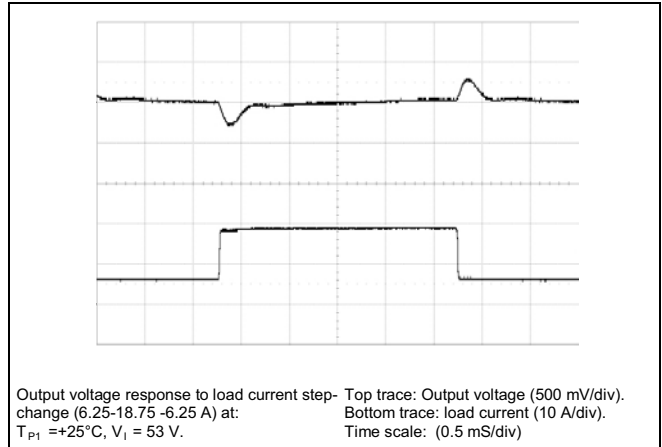

**Input Voltage Transient Response**

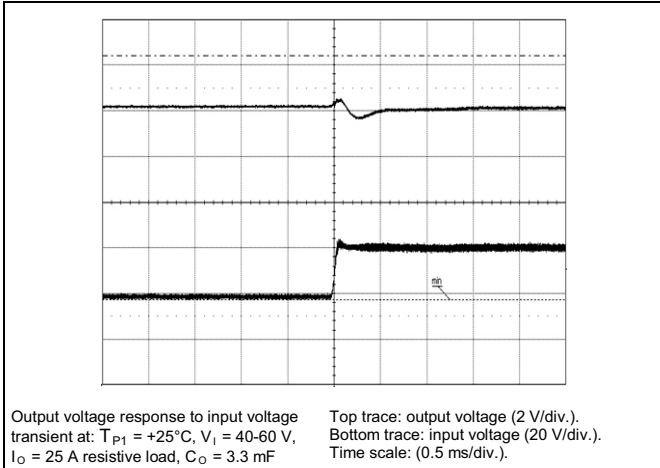

**Typical Characteristics**  
**12 V, 25 A, 300 W**

**Output Current Derating – Open frame**

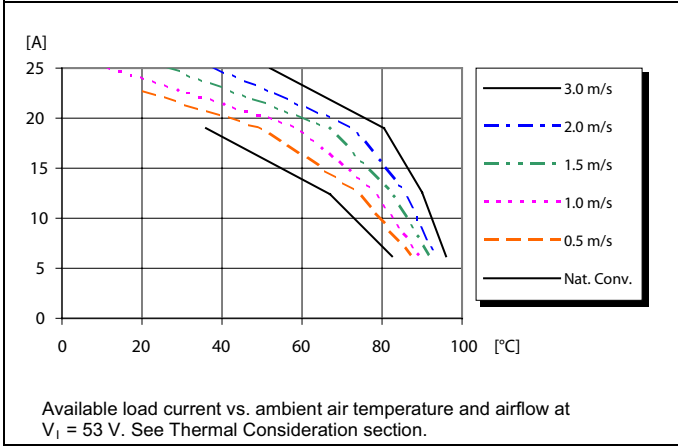

**Output Current Derating – Base plate**

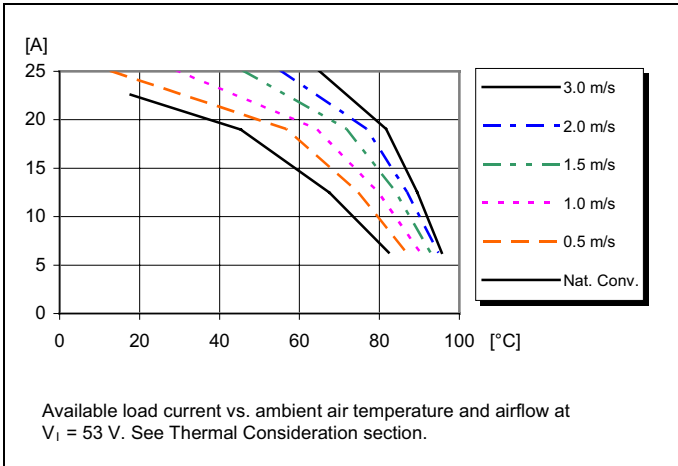

**Thermal Resistance – Base plate**

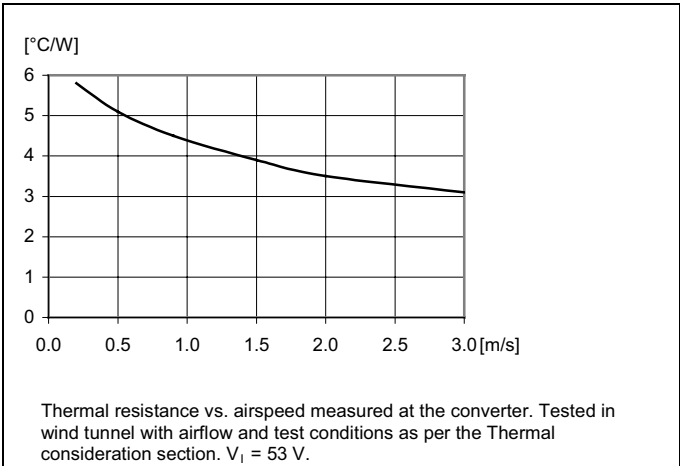

**Output Current Derating – Base plate + Heat sink**

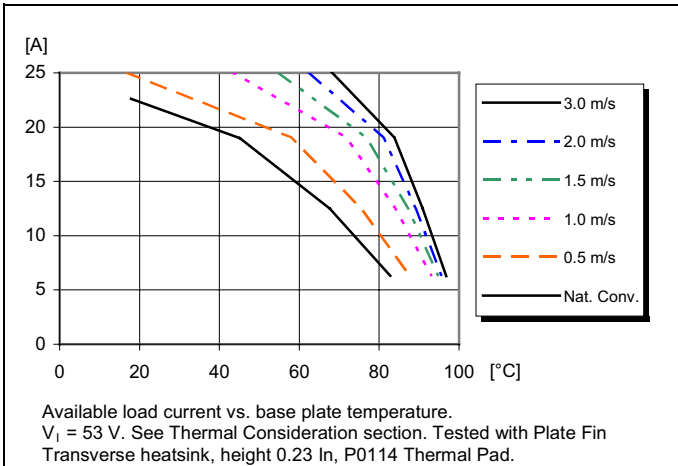

**Output Current Derating – Cold wall sealed box**

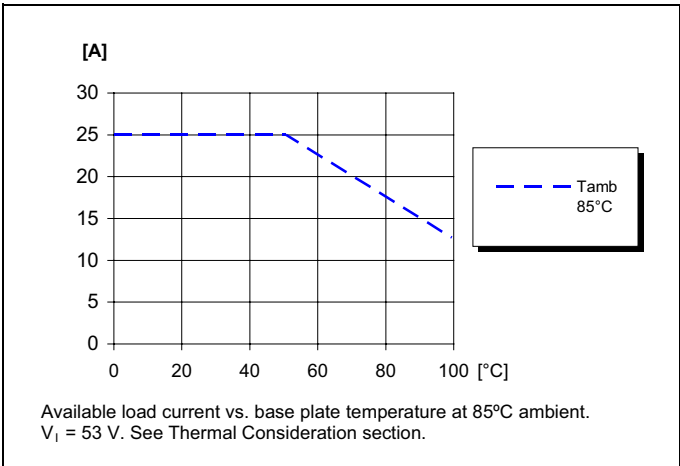

## Electrical Specification

### 12.45 V, 22 A, 261 W

$T_{p1} = -40$  to  $+90^{\circ}\text{C}$ ,  $V_I = 36$  to  $75\text{V}$ , sense pins connected to output pins unless otherwise specified under Conditions.

Typical values given at:  $T_{p1} = +25^{\circ}\text{C}$ ,  $V_I = 53\text{V}$ , max  $I_O$ , unless otherwise specified under Conditions.

Additional  $C_{in} = 0.1\text{mF}$ ,  $C_{out} = 0.1\text{mF}$ . See Operating Information section for selection of capacitor types.

Configuration File: 19010-CDA 102 0315/014

parameter	conditions/description	min	typ	max	units
input voltage range ( $V_I$ )		36		75	V
turn-off input voltage ( $V_{Ioff}$ )	decreasing input voltage	32	33	34	V
turn-on input voltage ( $V_{Ion}$ )	increasing input voltage	34	35	36	V
internal input capacitance ( $C_I$ )			11		$\mu\text{F}$
output power ( $P_O$ )		0		261	W
efficiency ( $\eta$ )	50% of max $I_O$		94.7		%
	max $I_O$		94.5		%
	50% of max $I_O$ , $V_I = 48\text{V}$		95.2		%
	max $I_O$ , $V_I = 48\text{V}$		94.8		%
power dissipation ( $P_d$ )	max $I_O$		15.3	21	W
input idling power ( $P_{II}$ )	$I_O = 0\text{A}$ , $V_I = 53\text{V}$		3.5		W
input standby power ( $P_{RC}$ )	$V_I = 53\text{V}$ (turned off with RC)		0.4		W
default switching frequency ( $f_s$ )	0-100% of max $I_O$	171	180	189	kHz
output voltage initial setting and accuracy ( $V_{O1}$ )	$T_{p1} = +25^{\circ}\text{C}$ , $V_I = 53\text{V}$ , $I_O = 0\text{A}$	12.415	12.45	12.485	V
output adjust range ( $V_O$ )	see operating information	6.9		13.2	V
output voltage tolerance band ( $V_O$ )	0-100% of max $I_O$	11.5		12.7	V
line regulation ( $V_O$ )	max $I_O$		100	250	mV
load regulation ( $V_O$ )	$V_I = 53\text{V}$ , 1-100% of max $I_O$	450	600	700	mV
load transient voltage deviation ( $V_{tr}$ )	$V_I = 53\text{V}$ , load step 25-75-25% of max $I_O$ , $di/dt = 1\text{A}/\mu\text{s}$ , $C_{out} = 2.2\text{mF}$ OSCON type		$\pm 350$		mV
load transient recovery time ( $t_{tr}$ )	$V_I = 53\text{V}$ , load step 25-75-25% of max $I_O$ , $di/dt = 1\text{A}/\mu\text{s}$ , $C_{out} = 2.2\text{mF}$ OSCON type		200		$\mu\text{s}$
ramp-up time ( $t_r$ ) - (from 10-90% of $V_{O1}$ )	10-100% of max $I_O$		23		ms
start-up time ( $t_s$ ) - (from $V_I$ connection to 90% of $V_{O1}$ )	10-100% of max $I_O$		38		ms
$V_I$ shut-down fall time ( $t_f$ ) - (from $V_I$ off to 10% of $V_O$ )	max $I_O$ $I_O = 0\text{A}$		0.7 6		ms s
RC start-up time ( $t_{RC}$ )	max $I_O$		26		ms
RC shut-down fall time ( $t_{RC}$ ) - (from RC off to 10% of $V_O$ )	max $I_O$ $I_O = 0\text{A}$		3.5 6		ms s
output current ( $I_O$ )		0		22	A
current limit threshold ( $I_{lim}$ )	$V_O = 10.8\text{V}$ , $T_{p1} < \text{max } T_{p1}$	24	25	26	A
short circuit current ( $I_{SC}$ )	$T_{p1} = 25^{\circ}\text{C}$ , see Note 1		7		A
recommended capacitive load ( $C_{Out}$ )	$T_{p1} = 25^{\circ}\text{C}$ , see Note 2	0	2.2	6	mF
output ripple & noise ( $V_{Oac}$ )	See ripple & noise section, $V_{O1}$		50	150	mVp-p
over voltage protection (OVP)	$T_{p1} = +25^{\circ}\text{C}$ , $V_I = 53\text{V}$ , 10-100 % of max $I_O$		15.6		V
remote control (RC)	sink current (note 3), see operating information trigger level, decreasing RC-voltage trigger level, increasing RC-voltage		2.6	0.7	mA
			2.9		V

Note 1: OCP in hic-cup mode

Note 2: Low ESR-value

Note 3: Sink current drawn by external device connected to the RC pin. Minimum sink current required to guarantee activated RC function.

**Typical Characteristics**  
**12.45 V, 40 A / 476 W, two products in parallel**

**Efficiency**

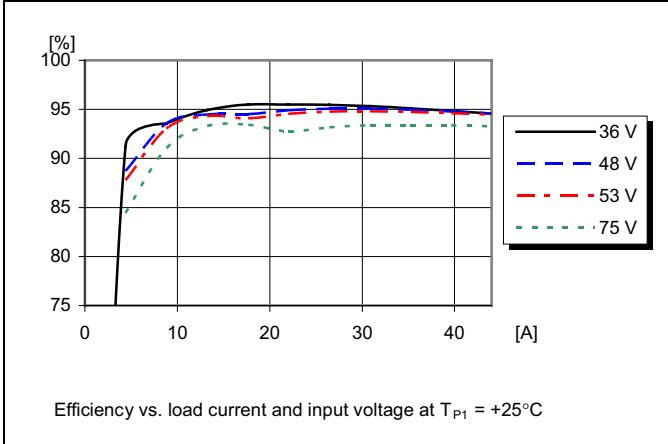

**Power Dissipation**

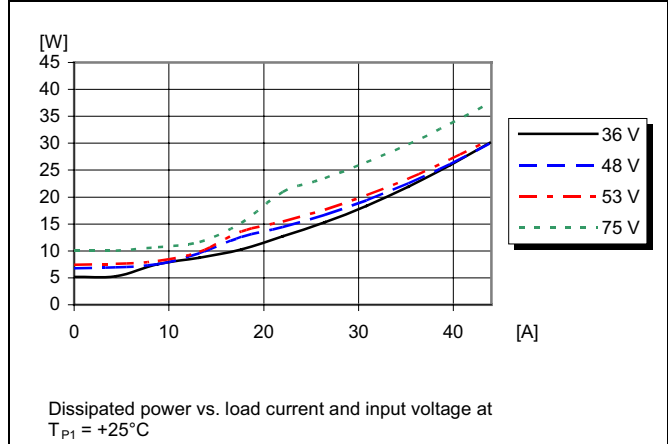

**Output Characteristics**

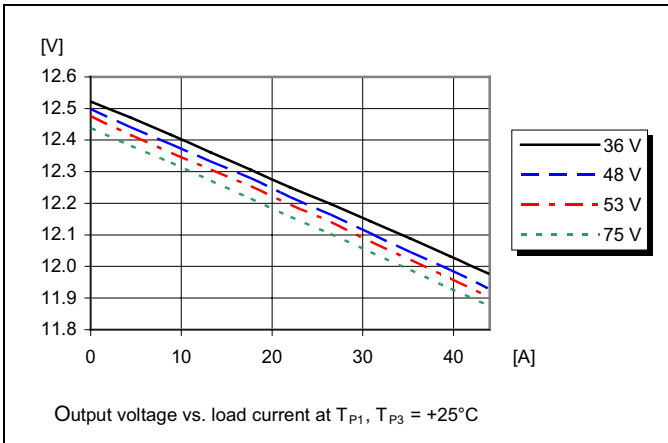

**Current Limit Characteristics**

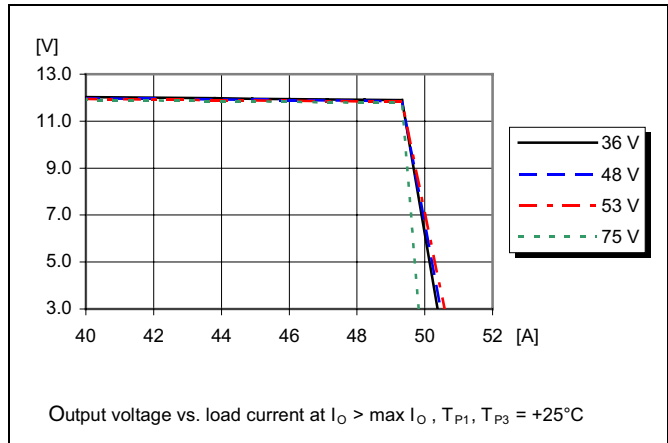

**Start-up**

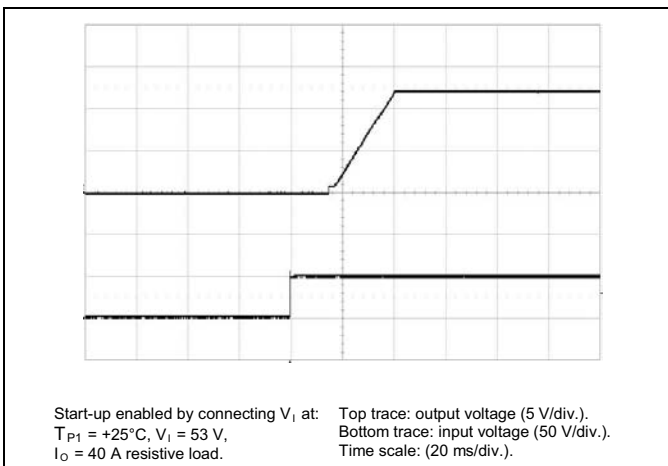

**Output Load Transient Response**

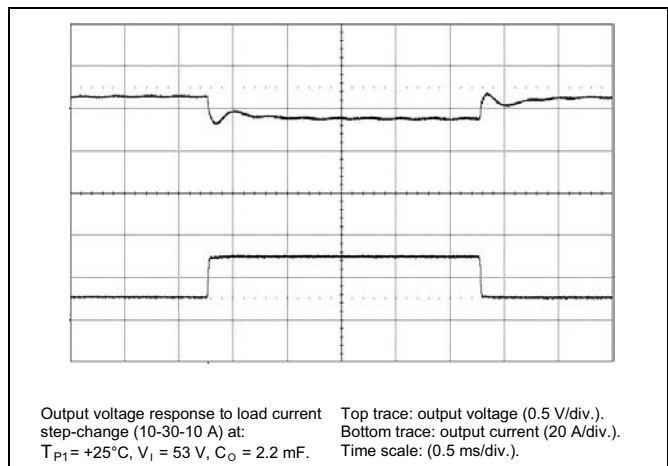

**Typical Characteristics**  
**12.45 V, 22 A, 261 W**

**Output Current Derating – Open frame**

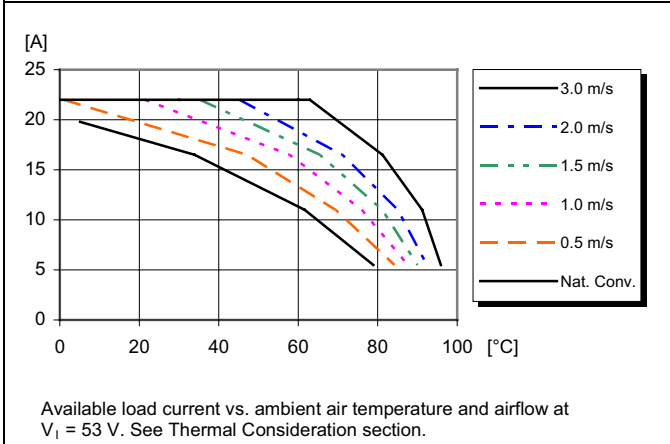

**Output Current Derating – Base plate**

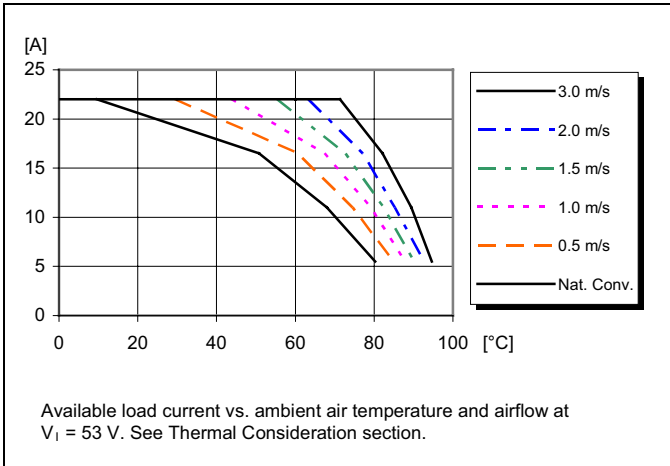

**Thermal Resistance – Base plate**

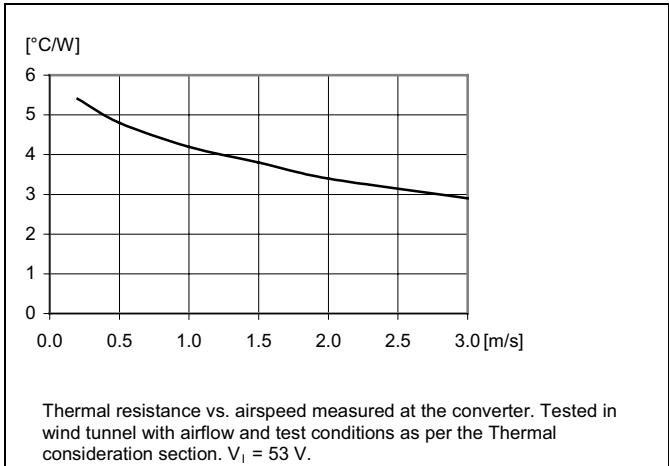

**Output Current Derating – Base plate + Heat sink**

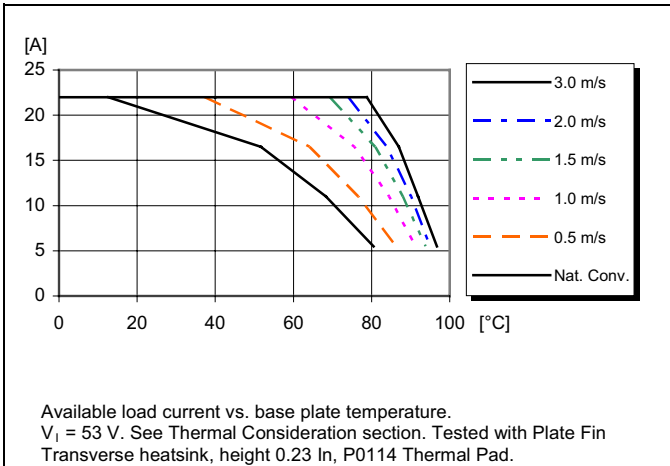

**Output Current Derating – Cold wall sealed box**

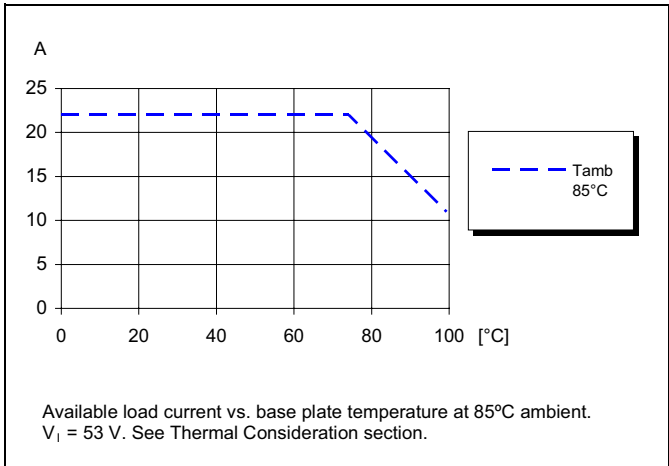



## Electrical Specification

### 12.45 V, 25 A, 296 W

$T_{P1} = -40$  to  $+90^{\circ}\text{C}$ ,  $V_I = 40$  to  $60$  V, sense pins connected to output pins unless otherwise specified under conditions. Typical values given at:  $T_{P1} = +25^{\circ}\text{C}$ ,  $V_I = 53$  V, max  $I_O$ , unless otherwise specified under conditions. Additional  $C_{out} = 0.1$  mF. See Operating Information section for selection of capacitor types. Configuration File: 19010-CDA1020315/017

parameter	conditions/description	min	typ	max	units
input voltage range ( $V_I$ )		40		60	V
turn-off input voltage ( $V_{Ioff}$ )	decreasing input voltage	36	37	38	V
turn-on input voltage ( $V_{Ion}$ )	increasing input voltage	38	39	40	V
internal input capacitance ( $C_I$ )			11		$\mu\text{F}$
output power ( $P_O$ )		0		296	W
efficiency ( $\eta$ )	50% of max $I_O$		95.2		%
	max $I_O$		94.6		%
	50% of max $I_O$ , $V_I = 48$ V		95.1		%
	max $I_O$ , $V_I = 48$ V		94.5		%
power dissipation ( $P_d$ )	max $I_O$		17	24	W
input idling power ( $P_{ii}$ )	$I_O = 0$ A, $V_I = 53$ V		4.4		W
input standby power ( $P_{RC}$ )	$V_I = 53$ V (turned off with RC)		0.4		W
default switching frequency ( $f_s$ )	0-100% of max $I_O$		180		kHz
output voltage initial setting and accuracy ( $V_{Oi}$ )	$T_{P1} = +25^{\circ}\text{C}$ , $V_I = 53$ V, $I_O = 0$ A	12.415	12.45	12.485	V
output adjust range ( $V_O$ )	see operating information	6.9		13.2	V
output voltage tolerance band ( $V_O$ )	0-100% of max $I_O$	11.5		12.7	V
line regulation ( $V_O$ )	max $I_O$		50	220	mV
load regulation ( $V_O$ )	$V_I = 53$ V, 1-100% of max $I_O$	400	500	700	mV
load transient voltage deviation ( $V_{tr}$ )	$V_I = 53$ V, load step 25-75-25% of max $I_O$ , $di/dt = 1$ A/ $\mu\text{s}$ , $C_{out} = 2.5$ mF OSCON type		$\pm 300$		mV
load transient recovery time ( $t_{tr}$ )	$V_I = 53$ V, load step 25-75-25% of max $I_O$ , $di/dt = 1$ A/ $\mu\text{s}$ , $C_{out} = 2.5$ mF OSCON type		250		$\mu\text{s}$
ramp-up time ( $t_r$ ) - (from 10-90% of $V_{Oi}$ )	10-100% of max $I_O$		23		ms
start-up time ( $t_s$ ) - (from $V_I$ connection to 90% of $V_{Oi}$ )	10-100% of max $I_O$		38		ms
$V_I$ shut-down fall time ( $t_f$ ) - (from $V_I$ off to 10% of $V_O$ )	max $I_O$		0.7		ms
	$I_O = 0$ A		6		s
RC start-up time ( $t_{RC}$ )	max $I_O$		14		ms
RC shut-down fall time ( $t_{RC}$ ) - (from RC off to 10% of $V_O$ )	max $I_O$		4		ms
	$I_O = 0$ A		6		s
output current ( $I_O$ )		0		25	A
current limit threshold ( $I_{lim}$ )	$T_{P1} < \text{max } T_{P1}$	27	30	33	A
short circuit current ( $I_{SC}$ )	$T_{P1} = 25^{\circ}\text{C}$ , see Note 1		11		A
recommended capacitive load ( $C_{out}$ )	$T_{P1} = 25^{\circ}\text{C}$ , see Note 2	0	2.5	10	mF
output ripple & noise ( $V_{Oac}$ )	See ripple & noise section, $V_{Oi}$		70	140	mVp-p
over voltage protection (OVP)	$T_{P1} = +25^{\circ}\text{C}$ , $V_I = 53$ V, 10-100 % of max $I_O$		15.6		V
remote control (RC)	sink current (note 3), see operating information trigger level, decreasing RC-voltage trigger level, increasing RC-voltage			0.7	mA
			2.6		V
			2.9		V

Note 1: OCP in hic-cup mode, rms value were recorded.

2: Low ESR-value

3: Sink current drawn by external device connected to the RC pin. Minimum sink current required to guarantee activated RC function.

**Typical Characteristics**  
**12.45 V, 45 A, 533 W, 2 products in parallel**

**Efficiency**

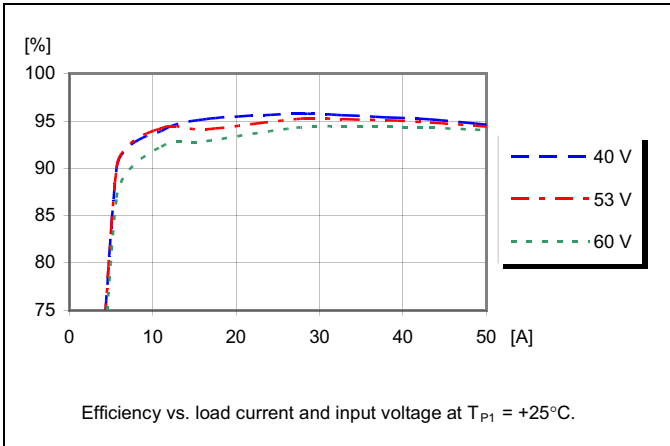

**Power Dissipation**

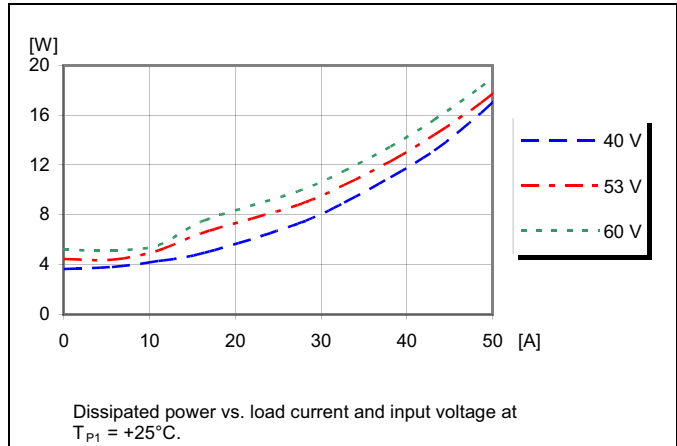

**Output Characteristics**

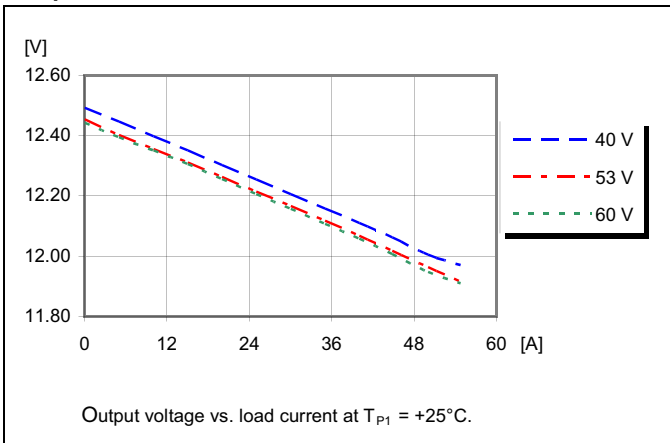

**Current Limit Characteristics**

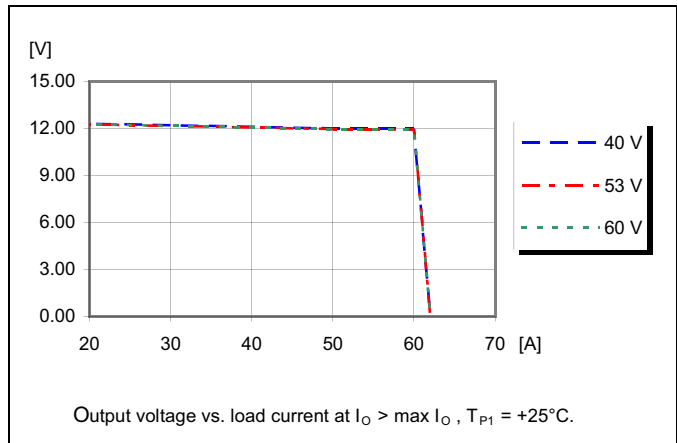

**Start-up**

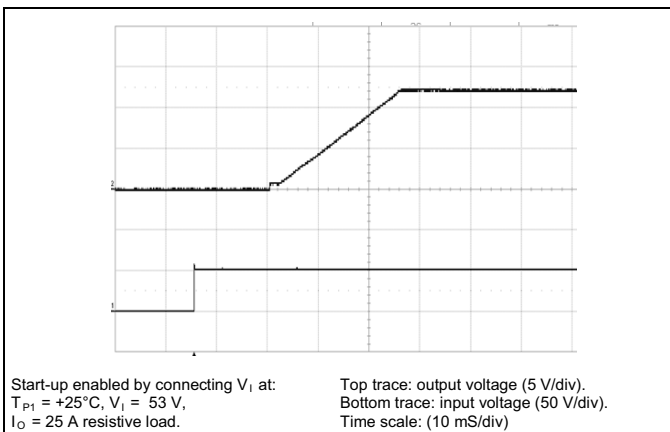

**Output Load Transient Response**

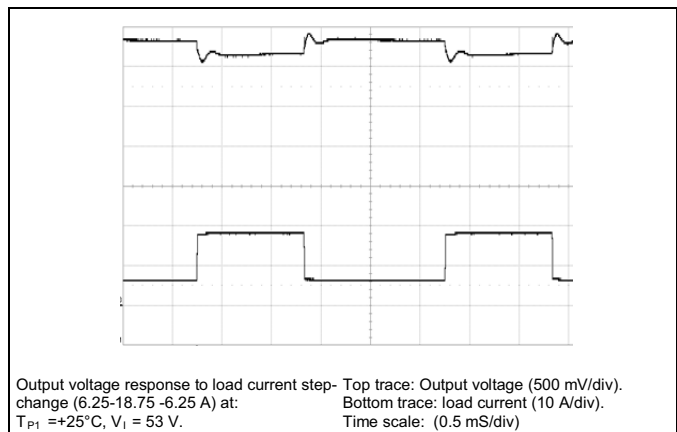

**Typical Characteristics**  
**12.45 V, 25 A, 296 W**

**Output Current Derating – Open frame**

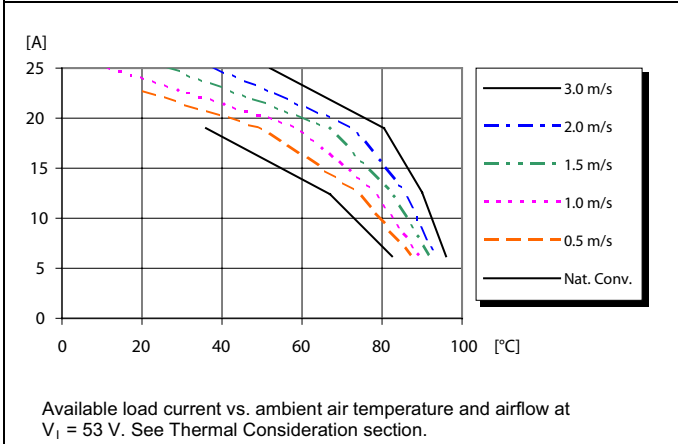

**Output Current Derating – Base plate**

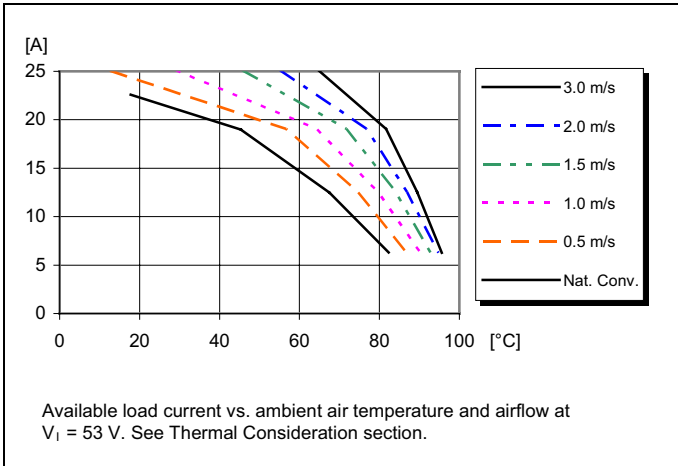

**Thermal Resistance – Base plate**

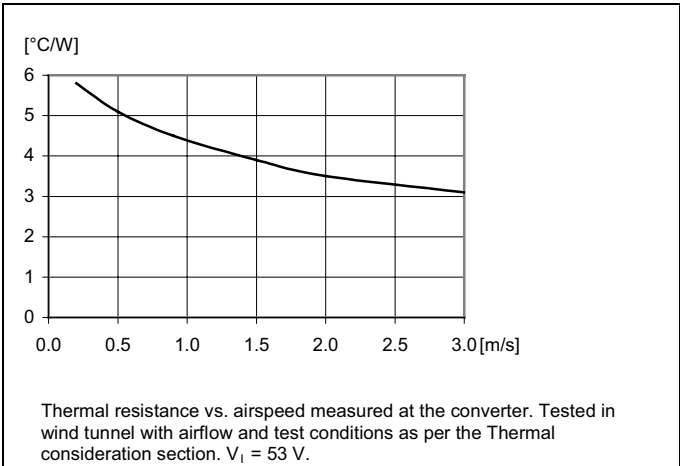

**Output Current Derating – Base plate + Heat sink**

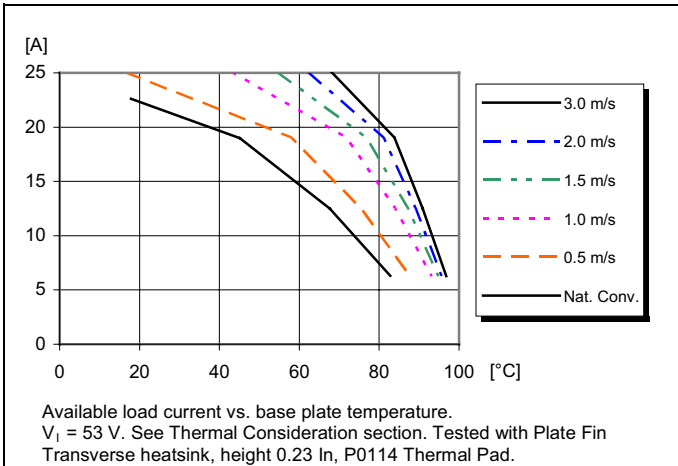

**Output Current Derating – Cold wall sealed box**

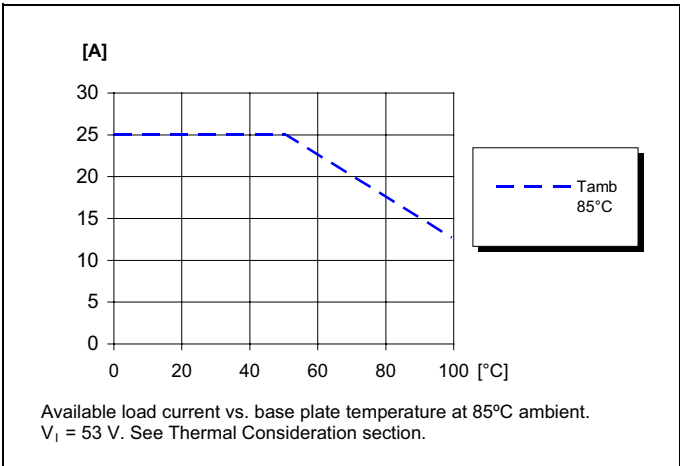

## EMC Specification

Conducted EMI measured according to EN55022, CISPR 22 and FCC part 15J (see test set-up). The fundamental switching frequency is 180 kHz for NEB at  $V_1 = 53\text{ V}$ , max  $I_o$ .

### Conducted EMI Input terminal value (typ)

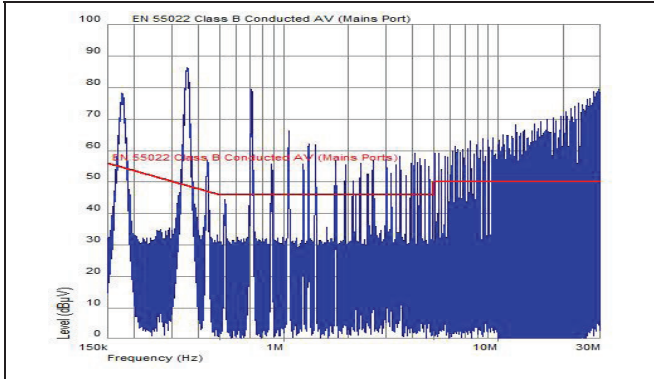

EMI without filter

### Optional external filter for class B

Suggested external input filter in order to meet class B in EN 55022, CISPR 22 and FCC part 15J.

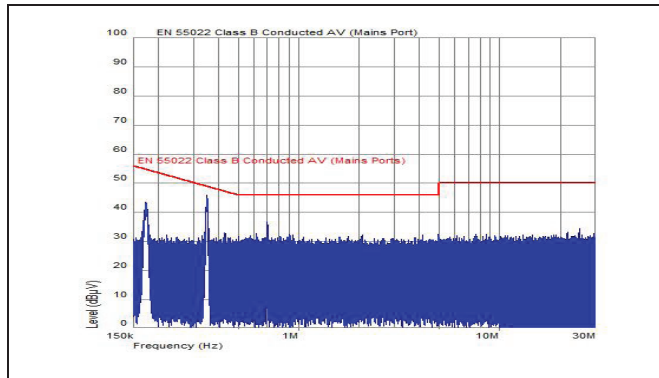
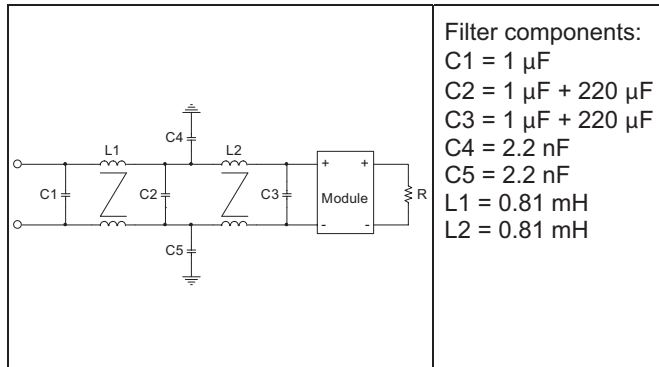

EMI with filter

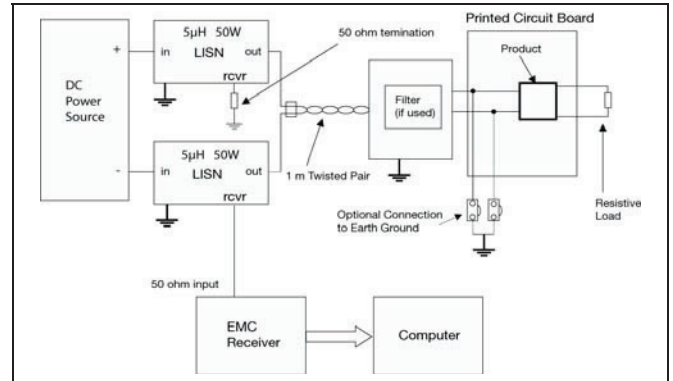

Test set-up

### Layout recommendations

The radiated EMI performance of the product will depend on the PWB layout and ground layer design. It is also important to consider the stand-off of the product. If a ground layer is used, it should be connected to the output of the product and the equipment ground or chassis.

A ground layer will increase the stray capacitance in the PWB and improve the high frequency EMC performance.

### Output ripple and noise

Output ripple and noise measured according to figure below.

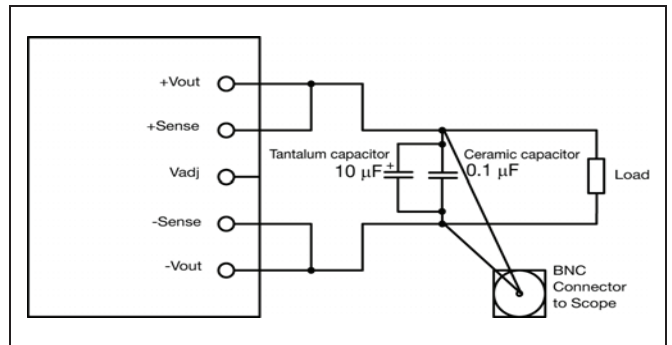

Output ripple and noise test setup

## Operating Information

### Power Management Overview

This product is equipped with a PMBus interface to allow the product to be configured, and communicate with system controllers. The product incorporates a wide range of readable and configurable power management features that are simple to implement with a minimum of external components. Additionally, the product includes protection features that continuously safeguard the load from damage due to unexpected system faults. A fault is also shown as an alert on the SALERT pin. The following product parameters can continuously be monitored by a host: Input voltage, output voltage/current, duty cycle and internal temperature.

The product is delivered with a default configuration suitable for a wide range operation in terms of input voltage, output voltage, and load. The configuration is stored in an internal Non-Volatile Memory (NVM). All power management functions can be reconfigured using the PMBus interface. Please contact your local CUI Power Modules representative for design support of custom configurations or appropriate SW tools for design and down-load of your own configurations.

### Input Voltage

The NEB consists of two different product families designed for two different input voltage ranges, 36 to 75 Vdc and 40 to 60 Vdc, see ordering information.

The input voltage range 36 to 75 Vdc meets the requirements of the European Telecom Standard ETS 300 132-2 for normal input voltage range in -48 and -60 Vdc systems, -40.5 to -57.0 V and -50.0 to -72 V respectively.

At input voltages exceeding 75 V, the power loss will be higher than at normal input voltage and TP1 must be limited to absolute max +125°C. The absolute maximum continuous input voltage is 80 Vdc.

The input voltage range 40 to 60 Vdc meets the requirements for normal input voltage range in -48 V systems, -40.5 to -57.0 V. At input voltages exceeding 60 V, the power loss will be higher than at normal input voltage and TP1 must be limited to absolute max +125°C. The absolute maximum continuous input voltage is 65 Vdc.

### Turn-off Input Voltage

The product monitors the input voltage and will turn on and turn off at predetermined levels. The minimum hysteresis between turn on and turn off input voltage is 2 V. The turn on and turn off levels of the product can be reconfigured using the PMBus interface

### Remote Control (RC)

The products are fitted with a configurable remote control function. The primary remote control is referenced to the primary negative input connection (-In). The RC function allows the converter to be turned on/off by an external device like a semiconductor or mechanical switch. The RC

pin has an internal pull up resistor. The remote control functions can also be configured using the PMBus

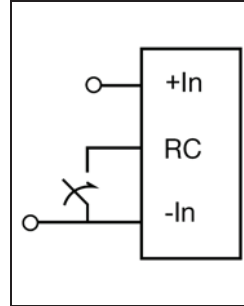

The device should be capable of sinking 0.7 mA. When the RC pin is left open, the voltage generated on the RC pin is max 6 V. The standard product is provided with "negative logic" remote control and will be off until the RC pin is connected to the -In. To turn on the product the voltage between RC pin and -In should be less than 1 V.

To turn off the product the RC pin should be left open for a minimum of time 150  $\mu$ s, the same time requirement applies when the product shall turn on. In situations where it is desired to have the product to power up automatically without the need for control signals or a switch, the RC pin can be wired directly to -In or disabled via the 0xE3 command. The logic option for the primary remote control is configured via 0xE3 command using the PMBus.

### Remote Control (secondary side)

The CTRL-pin can be configured as remote control via the PMBus interface. In the default configuration the CTRL-pin is disabled and floating. The output can be configured to internal pull-up to 3.3 V using the MFR\_MULTI\_PIN\_CONFIG (0xF9) PMBus command. The CTRL-pin can be left open when not used. The logic options for the secondary remote control can be positive or negative logic. The logic option for the secondary remote control is configured via ON\_OFF\_CONFIG (0x02) command using the PMBus interface, see also MFR\_MULTI\_PIN\_CONFIG section.

### Input and Output Impedance

The impedance of both the input source and the load will interact with the impedance of the product. It is important that the input source has low characteristic impedance. Minimum recommended external input capacitance is 100  $\mu$ F. The performance in some applications can be enhanced by addition of external capacitance as described under External Decoupling Capacitors.

### External Decoupling Capacitors

When powering loads with significant dynamic current requirements, the voltage regulation at the point of load can be improved by addition of decoupling capacitors at the load. The most effective technique is to locate low ESR ceramic and electrolytic capacitors as close to the load as possible, using several parallel capacitors to lower the effective ESR. The ceramic capacitors will handle high-frequency dynamic load changes while the electrolytic capacitors are used to handle low frequency dynamic load changes. Ceramic capacitors will also reduce any high frequency noise at the load. It is equally important to use low resistance and low inductance PWB layouts and cabling. External decoupling capacitors will become part of

the product's control loop. The control loop is optimized for a wide range of external capacitance and the maximum recommended value that could be used without any additional analysis is found in the electrical specification. The ESR of the capacitors is a very important parameter. Stable operation is guaranteed with a verified ESR value of  $>10\text{ m}\Omega$  across the output connections. For further information please contact your local CUI Power Modules representative.

### Parallel Operation (Droop Load Share, DLS)

The NEB DLS products are variants that can be connected in parallel. The products have a pre-configured voltage droop: The stated output voltage set point is at no load. The output voltage will decrease when the load current is increased. The voltage will droop 0.6 V while load reaches max load. This feature allows the products to be connected in parallel and share the current with 10% accuracy. Up to 90% of max output current can be used from each product.

When running DLS-products in parallel command (0xF9) must be set according to MFR\_MULTI\_PIN\_CONFIG. To prevent unnecessary current stress, changes of the output voltage must be done with the output disabled. This must be considered for all commands that affect the output voltage.

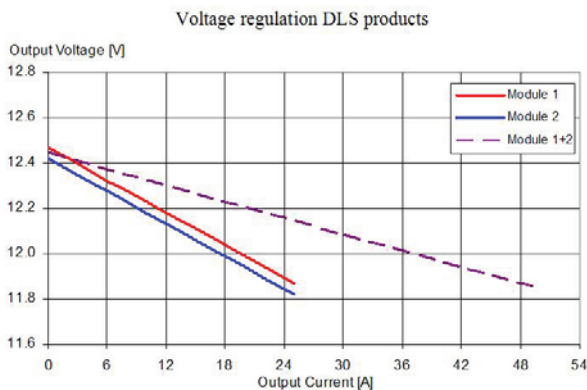

### Feed Forward Capability

The NEB products have a feed forward function implemented that can handle sudden input voltage changes. The output voltage will be regulated during an input transient and will typically stay within 10% when an input transient is applied.

### PMBus configuration and support

The product provides a PMBus digital interface that enables the user to configure many aspects of the device operation as well as monitor the input and output parameters. Please contact your local CUI Power Modules representative for appropriate SW tools to down-load new configurations.

### Output Voltage Adjust using PMBus

The output voltage of the product can be reconfigured using the PMBus interface.

### Margin Up/Down Controls

These controls allow the output voltage to be momentarily adjusted, either up or down, by a nominal 10%. This provides a convenient method for dynamically testing the operation of the load circuit over its supply margin or range. It can also be used to verify the function of supply voltage supervisors.

The margin up and down levels of the product can be re-configured using the PMBus interface.

### Soft-start Power Up

The default rise time of the ramp up is 10 ms. When starting by applying input voltage the control circuit boot-up time adds an additional 15 ms delay. The soft-start power up of the product can be reconfigured using the PMBus interface.

The DLS variants have a pre-configured ramp up time of 25 ms.

### Remote Sense

The product has remote sense that can be used to compensate for voltage drops between the output and the point of load. The sense traces should be located close to the PWB ground layer to reduce noise susceptibility. The remote sense circuitry will compensate for up to 10% voltage drop between output pins and the point of load. If the remote sense is not needed +Sense should be connected to +Out and -Sense should be connected to -Out. To be able to use remote sense the converter must be equipped with a Communication interface.

### Temperature Protection (OTP, UTP)

The products are protected from thermal overload by an internal temperature shutdown protection. When TP1 as defined in thermal consideration section is exceeded the product will shut down. The product will make continuous attempts to start up (non-latching mode) and resume normal operation automatically when the temperature has dropped below the temperature threshold set in the command OT\_WARN\_LIMIT (0x51); the hysteresis is defined in general electrical specification. The OTP and hysteresis of the product can be re-configured using the PMBus interface. The product has also an under temperature protection. The OTP and UTP fault limit and fault response can be configured via the PMBus. Note: using the fault response "continue without interruption" may cause permanent damage to the product.

### Over Voltage Protection (OVP)

The product includes over voltage limiting circuitry for protection of the load. The default OVP limit is 30% above the nominal output voltage. If the output voltage exceeds the OVP limit, the product can respond in different ways. The default response from an over voltage fault is to

immediately shut down. The device will continuously check for the presence of the fault condition, and when the fault condition no longer exists the device will be re-enabled. The OVP fault level and fault response can be re-configured using the PMBus interface.

**Over Current Protection (OCP)**

The product includes current limiting circuitry for protection at continuous overload. The default setting for the product is hic-up mode if the maximum output current is exceeded and the output voltage is below  $0.3 \times V_{out}$ , set in command IOUT\_OC\_LV\_FAULT\_LIMIT (0x48). Above the trip voltage value in command 0x48 the product will continue operate while maintaining the output current at the value set by IOUT\_OC\_FAULT\_LIMIT (0x46). The load distribution should be designed for the maximum output short circuit current specified.

Droop Load Share variants (DLS) will enter hic-up mode, with a trip voltage,  $0.04 \times V_{out}$ , set in command IOUT\_OC\_LV\_FAULT\_LIMIT (0x48). Above the trip voltage in command (0x48) the product will continue operate while maintaining the output current at the value set by IOUT\_OC\_FAULT\_LIMIT (0x46).

The over current protection of the product can be reconfigured using the PMBus interface.

**Input Over/Under voltage protection**

The input of the product can be protected from high input voltage and low input voltage. The over/under-voltage fault level and fault response can be configured via the PMBus interface.

**Pre-bias Start-up Capability**

The product has a Pre-bias start up functionality and will not sink current during start up if a Pre-bias source is present at the output terminals. If the Pre-bias voltage is lower than the target value set in VOUT\_COMMAND (0x21), the product will ramp up to the target value. If the Pre-bias voltage is higher than the target value set in VOUT\_COMMAND (0x21), the product will ramp down to the target value and in this case sink current for a limited of time set in the command TOFF\_MAX\_WARN\_LIMIT (0x66).

**Power Good**

The product provides Power Good (PG) flag in the Status Word register that indicates the output voltage is within a specified tolerance of its target level and no fault condition exists. If specified in section Connections, the product also provides a PG signal output. The Power Good signal is by default configured as active low, Push-pull and can be re-configured via the PMBus interface. The Power Good output can be configured as Push-pull or "High Z when active" to permit AND'ing of parallel devices. It is not recommended to use Push-pull when paralleling PG-pins, see MFR\_MULTI\_PIN\_CONFIG.

**Synchronization, Tracking and External reference**

This product does not support synchronization, tracking or external reference.

**Switching frequency adjust using PMBus**

The switching frequency is set to 180 kHz as default but this can be reconfigured via the PMBus interface. The product is optimized at this frequency but can run at lower and higher frequency, (170 kHz – 190 kHz). The electrical performance can be affected if the switching frequency is changed.

**MFR\_MULTI\_PIN\_CONFIG**

The MFR\_MULTI\_PIN\_CONFIG (0xF9) command enables or disables different functions inside the product. This command can be configured according to the table for different functions.

Bit 7:6 00 = Stand alone 01 = Slave (N/A) 10 = DLS 11 = Master (N/A)	1	1	1	1	1	1	0	0	0	0	0	0
Bit 5 Power Good High Z when active	0	0	0	0	1	1	0	0	0	0	1	1
Bit 4 Tracking enable (N/A)	0	0	0	0	0	0	0	0	0	0	0	0
Bit 3 External reference (N/A)	0	0	0	0	0	0	0	0	0	0	0	0
Bit 2 Power Good Enable	0	0	1	1	1	1	0	0	1	1	1	1
Bit 1 Reserved	1	1	1	1	1	1	0	0	0	0	0	0
Bit 0 Secondary Remote Control Pull up/down resistor enable 1)	0	1	0	1	0	1	0	1	0	1	0	1
1) When not used with PMBus, the CTRL input can be internally pulled up or down depending on if it is active high or low. When active low it will be pulled up and vice versa	DLS, PMBus Control (0x82)	DLS, Sec RC w/ pull up/down (0x83)	DLS, Power Good Push-pull, PMBus Control (0x86)	DLS, Power Good Push-pull, Sec RC w/ pull up/down (0x87)	DLS, Power Good High Z when active, PMBus Control (0xA6)	DLS, Power Good High Z when active, Sec RC w/ pull up/down (0xA7)	Stand alone, PMBus Control (0x00)	Stand alone, Sec RC w/ pull up/down (0x01)	Stand alone, Power Good Push-pull, PMBus Control (0x04)	Stand alone, Power Good Push-pull, Sec RC w/ pull up/down (0x05)	Stand alone, Power Good High Z when active, PMBus Control (0x24)	Stand alone, Power Good High Z when active, Sec RC w/ pull up/down (0x25)

The MFR\_MULTI\_PIN\_CONFIG can be reconfigured using the PMBus interface. Default configuration is set to Power Good Push-Pull (0x04) for stand alone variants and DLS Power Good Push-Pull (0x86) for Droop Load Share variants.

**User customized settings**

This product has 2 data storage set: Default data (CUI factory) and User data. The User data set's priority is higher than the Default data. The User data area is empty while shipped to customer. After boot-up, if the controller found no data stored in User data area, it will load Default data instead. Customer can change the RAM data and store the changes into flash memory by PMBUS Store\_User\_All, next power cycle will load the User data into RAM for execute.

Store\_Default\_All is write protected to ensure the factory settings is always available for recovery.

**Output Voltage Regulation**

The NEB products are designed to be fully regulated within the plotted area. Operating outside this area is not recommended.

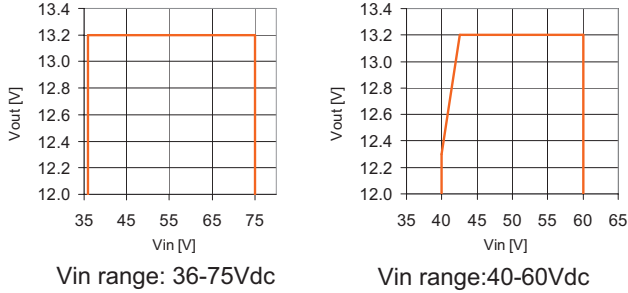

**Thermal Consideration**

**General**

The product is designed to operate in different thermal environments and sufficient cooling must be provided to ensure reliable operation.

For products mounted on a PWB without a heat sink attached, cooling is achieved mainly by conduction, from the pins to the host board, and convection, which is dependant on the airflow across the product. Increased airflow enhances the cooling of the product. The Output Current Derating graph found in the output section for each model provides the available output current vs. ambient air temperature and air velocity at VI = 53 V.

The product is tested on a 254 x 254 mm, 35 μm (1 oz), 16-layer test board mounted vertically in a wind tunnel with a cross-section of 608 x 203 mm

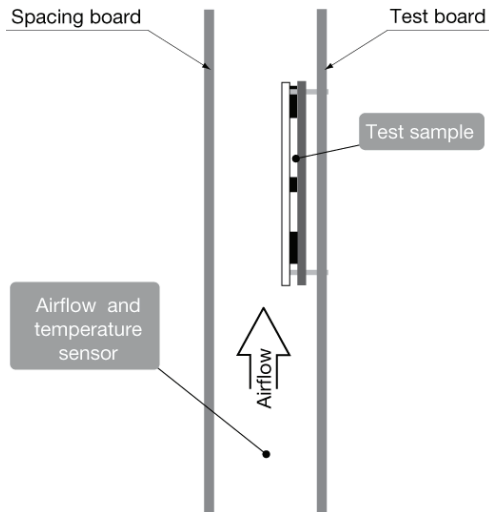

For products with base plate used in a sealed box/cold wall application, cooling is achieved mainly by conduction through the cold wall. The Output Current Derating graphs are found in the output section for each model. The product is tested in a sealed box test set up with ambient temperatures 85, 55 and 25°C.

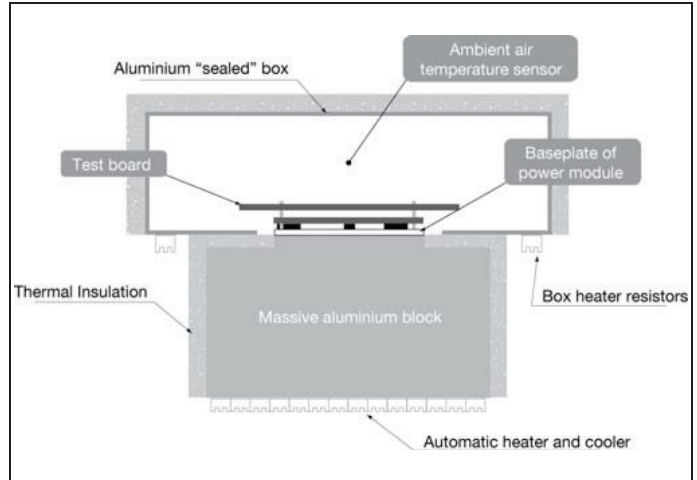

**Definition of product operating temperature**

The product operating temperature is used to monitor the temperature of the product, and proper thermal conditions can be verified by measuring the temperature at positions P1, P2, P3 and P4. The temperature at these positions (TP1, TP2, TP3, TP4) should not exceed the maximum temperatures in the table below. The number of measurement points may vary with different thermal design and topology. Temperatures above maximum TP1, measured at the reference point P1 (both for openframe and base plate versions) are not allowed and may cause permanent damage.



Position	Description	Max temperature
P1	PWB (reference point, open frame and base-plate)	$T_{P1}=125^{\circ}\text{C}$
P2	Opto-coupler	$T_{P2}=105^{\circ}\text{C}$
P3	Secondary MOSFET	$T_{P3}=125^{\circ}\text{C}$
P4	Magnetic Core	$T_{P4}=125^{\circ}\text{C}$

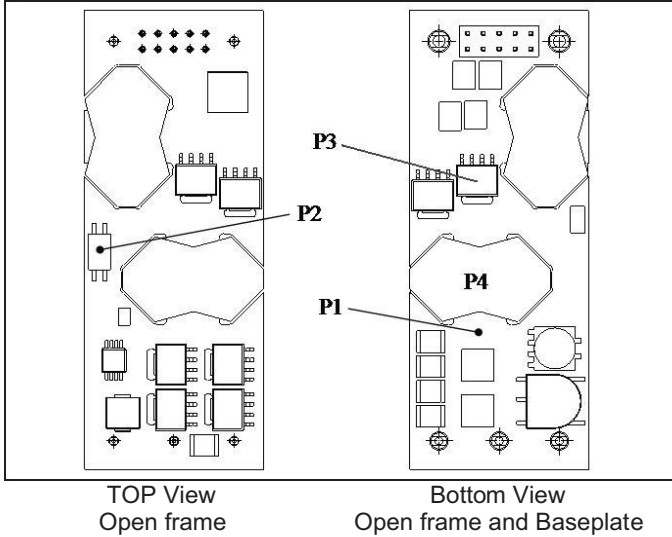

**Connections (Top view)**

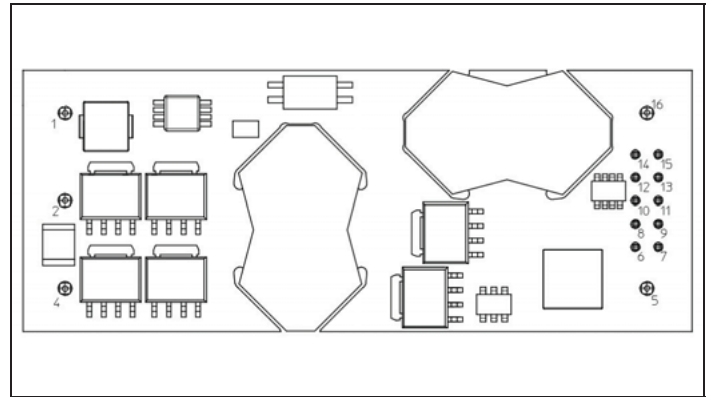

Pin	Designation	Function
1	+In	Positive Input
2	RC	Remote Control
4	-In	Negative Input
5	-Out	Negative Output
6	S+	Positive Remote Sense
7	S-	Negative Remote Sense
8	SA0	Address pin 0
9	SA1	Address pin 1
10	SCL	PMBus Clock
11	SDA	PMBus Data
12	PG	Power Good output
13	DGND	PMBus ground
14	SALERT	PMBus alert signal
15	CTRL	PMBus remote control
16	+Out	Positive Output

(Best air flow direction is from negative to positive pins.)

**Ambient Temperature Calculation**

For products with base plate the maximum allowed ambient temperature can be calculated by using the thermal resistance.

1. The power loss is calculated by using the formula  $((1/\eta) - 1) \times \text{output power} = \text{power losses } (P_d)$ .  
 $\eta$  = efficiency of product. E.g. 95 % = 0.95
2. Find the thermal resistance ( $R_{th}$ ) in the Thermal Resistance graph found in the Output section for each model. **Note that the thermal resistance can be significantly reduced if a heat sink is mounted on the top of the base plate.**

Calculate the temperature increase ( $\Delta T$ ).  
 $\Delta T = R_{th} \times P_d$

3. Max allowed ambient temperature is:  
 Max  $T_{p1} - \Delta T$ .

E.g. NEB-264 at 2m/s:

1.  $((1/0.945) - 1) \times 264\text{ W} = 15.4\text{ W}$
2.  $15.4\text{ W} \times 3.4^{\circ}\text{C/W} = 52^{\circ}\text{C}$
3.  $125^{\circ}\text{C} - 52^{\circ}\text{C} = \text{max ambient temperature is } 73^{\circ}\text{C}$   
 The actual temperature will be dependent on several factors such as the PWB size, number of layers and direction of airflow.

## PMBus Interface

This product provides a PMBus digital interface that enables the user to configure many aspects of the device operation as well as to monitor the input and output voltages, output current and device temperature. The product can be used with any standard two-wire I<sup>2</sup>C or SMBus host device. In addition, the product is compatible with PMBus version 1.2 and includes an SALERT line to help mitigate bandwidth limitations related to continuous fault monitoring. The product supports 100 kHz and 400 kHz bus clock frequency only. The PMBus signals, SCL, SDA and SALERT require passive pull-up resistors as stated in the SMBus Specification. Pull-up resistors are required to guarantee the rise time as follows:

$$\text{Eq. 7} \quad \tau = R_p C_p \leq 1\mu\text{s}$$

where  $R_p$  is the pull-up resistor value and  $C_p$  is the bus load. The maximum allowed bus load is 400 pF. The pull-up resistor should be tied to an external supply between 2.7 to 5.5 V, which should be present prior to or during power-up. If the proper power supply is not available, voltage dividers may be applied. Note that in this case, the resistance in the equation above corresponds to parallel connection of the resistors forming the voltage divider.

It is recommended to always use PEC (Packet Error Check) when communicating via PMBus. For these products it is a requirement to use PEC when using Send Byte to the device, for example command "RESTORE\_DEFAULT\_ALL".

### Monitoring via PMBus

A system controller (host device) can monitor a wide variety of parameters through the PMBus interface. The controller can monitor fault conditions by monitoring the SALERT pin, which will be asserted when any number of pre-configured fault or warning conditions occur. The system controller can also continuously monitor any number of power conversion parameters including but not limited to the following:

- Input voltage
- Output voltage
- Output current
- Internal junction temperature
- Switching frequency (Monitors the set value not actual frequency)
- Duty cycle

### Software Tools for Design and Production

For this products CUI provides software for configuring and monitoring via the PMBus interface. For more information please contact your local CUI sales representative.

### PMBus Addressing

The following figure and table show recommended resistor values with min and max voltage range for hard-wiring PMBus addresses (series E12, 1% tolerance resistors suggested):

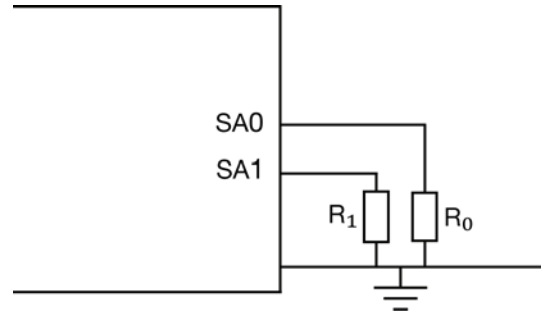

Schematic of connection of address resistors.

SA0/SA1 Index	R <sub>SA0</sub> /R <sub>SA1</sub> [kΩ]
0	10
1	22
2	33
3	47
4	68
5	100
6	150
7	220

The SA0 and SA1 pins can be configured with a resistor to GND according to the following equation.

$$\text{PMBus Address} = 8 \times (\text{SA0value}) + (\text{SA1 value})$$

If the calculated PMBus address is 0, 11 or 12, PMBus address 127 is assigned instead. From a system point of view, the user shall also be aware of further limitations of the addresses as stated in the PMBus Specification. It is not recommended to keep the SA0 and SA1 pins left open.

### I<sup>2</sup>C/SMBus – Timing

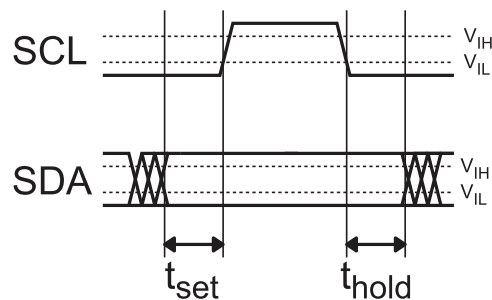

Setup and hold times timing diagram

The setup time,  $t_{set}$ , is the time data, SDA, must be stable before the rising edge of the clock signal, SCL. The hold time  $t_{hold}$ , is the time data, SDA, must be stable after the rising edge of the clock signal, SCL. If these times are violated incorrect data may be captured or meta-stability may occur and the bus communication may fail. When configuring the product, all standard SMBus protocols must be followed, including clock stretching. Additionally,

a bus-free time delay between every SMBus transmission (between every stop & start condition) must occur. Refer to the SMBus specification, for SMBus electrical and timing requirements. Note that an additional delay of 5 ms has to be inserted in case of storing the RAM content into the internal non-volatile memory.

## PMBus Commands

The products are PMBus compliant. The following table lists the implemented PMBus read commands. For more detailed information see PMBus Power System Management Protocol Specification; Part I – General Requirements, Transport and Electrical Interface and PMBus Power System Management Protocol; Part II – Command Language.

Designation	Cmd	Prot
<b>Standard PMBus Commands</b>		
<i>Control Commands</i>		
OPERATION	01h	No
ON_OFF_CONFIG	02h	No
WRITE_PROTECT	10h	No
<i>Output Commands</i>		
VOUT_MODE	20h	No
VOUT_COMMAND	21h	No
VOUT_TRIM	22h	No
VOUT_CAL_OFFSET	23h	Yes
VOUT_MAX	24h	No
VOUT_MARGIN_HIGH	25h	No
VOUT_MARGIN_LOW	26h	No
VOUT_TRANSITION_RATE	27h	No
VOUT_SCALE_LOOP	29h	Yes
VOUT_SCALE_MONITOR	2Ah	Yes
MAX_DUTY	32h	No
FREQUENCY_SWITCH	33h	No
VIN_ON	35h	No
VIN_OFF	36h	No
IOUT_CAL_GAIN	38h	Yes
IOUT_CAL_OFFSET	39h	Yes
<i>Fault Commands</i>		
VOUT_OV_FAULT_LIMIT	40h	No
VOUT_OV_FAULT_RESPONSE	41h	No
VOUT_OV_WARN_LIMIT	42h	No
VOUT_UV_WARN_LIMIT	43h	No
VOUT_UV_FAULT_LIMIT	44h	No
VOUT_UV_FAULT_RESPONSE	45h	No
IOUT_OC_FAULT_LIMIT	46h	No

Designation	Cmd	Prot
IOUT_OC_FAULT_RESPONSE	47h	No
IOUT_OC_LV_FAULT_LIMIT	48h	No
IOUT_OC_WARN_LIMIT	4Ah	No
OT_FAULT_LIMIT	4Fh	No
OT_FAULT_RESPONSE	50h	No
OT_WARN_LIMIT	51h	No
UT_WARN_LIMIT	52h	No
UT_FAULT_LIMIT	53h	No
UT_FAULT_RESPONSE	54h	No
VIN_OV_FAULT_LIMIT	55h	No
VIN_OV_FAULT_RESPONSE	56h	No
VIN_OV_WARN_LIMIT	57h	No
VIN_UV_WARN_LIMIT	58h	No
VIN_UV_FAULT_LIMIT	59h	No
VIN_UV_FAULT_RESPONSE	5Ah	No
POWER_GOOD_ON	5Eh	No
POWER_GOOD_OFF	5Fh	No
<i>Time setting Commands</i>		
TON_DELAY	60h	No
TON_RISE	61h	No
TON_MAX_FAULT_LIMIT	62h	No
TON_MAX_FAULT_RESPONSE	63h	No
TOFF_DELAY	64h	No
TOFF_FALL	65h	No
TOFF_MAX_WARN_LIMIT	66h	No
<i>Status Commands (Read Only)</i>		
CLEAR_FAULTS	03h	No
STATUS_BYTES	78h	No
STATUS_WORD	79h	No
STATUS_VOUT	7Ah	No
STATUS_IOUT	7Bh	No
STATUS_INPUT	7Ch	No
STATUS_TEMPERATURE	7Dh	No
STATUS_CML	7Eh	No
STATUS_OTHER	7Fh	No
<i>Monitor Commands (Read Only)</i>		
READ_VIN	88h	No
READ_VOUT	8Bh	No
READ_IOUT	8Ch	No
READ_TEMPERATURE_1	8Dh	No
READ_TEMPERATURE_2	8Eh	No
READ_DUTY_CYCLE	94h	No

Designation	Cmd	Prot
READ_FREQUENCY	95h	No
<i>Configuration and Control Commands</i>		
USER_DATA_00	80h	No
<i>Identification Commands (Read Only)</i>		
PMBUS_REVISION	98h	No
MFR_ID	99h	Yes
MFR_MODEL	9Ah	Yes
MFR_REVISION	9Bh	Yes
MFR_LOCATION	9Ch	Yes
MFR_DATE	9Dh	Yes
MFR_SERIAL	9Eh	Yes
<i>Supervisory Commands</i>		
STORE_DEFAULT_ALL	11h	Yes
RESTORE_DEFAULT_ALL	12h	No
STORE_USER_ALL	15h	No
RESTORE_USER_ALL	16h	No
CAPABILITY	19h	No
<i>Product Specific Commands</i>		
MFR_POWER_GOOD_POLARITY	D0h	No
MFR_VIN_SCALE_MONITOR	D3h	Yes
MFR_SELECT_TEMP_SENSOR	DCh	No
MFR_VIN_OFFSET	DDh	Yes
MFR_VOUT_OFFSET_MONITOR	DEh	Yes
MFR_TEMP_OFFSET_INT	E1h	No
MFR_REMOTE_TEMP_CAL	E2h	No
MFR_REMOTE_CTRL	E3h	No
MFR_DEAD_BAND_DELAY	E5h	Yes
MFR_TEMP_COEFF	E7h	Yes
MFR_DEBUG_BUFF	F0h	No
MFR_SETUP_PASSWORD	F1h	No
MFR_DISABLE_SECURITY_ONCE	F2h	No
MFR_DEAD_BAND_IOUT_THRESHOLD	F3h	Yes
MFR_SECURITY_BIT_MASK	F4h	Yes
MFR_PRIMARY_TURN	F5h	Yes
MFR_SECONDARY_TURN	F6h	Yes
MFR_ILIM_SOFTSTART	F8h	No
MFR_MULTI_PIN_CONFIG	F9h	No
MFR_DEAD_BAND_VIN_THRESHOLD	FAh	Yes
MFR_DEAD_BAND_VIN_IOUT_HYS	FBh	Yes
MFR_RESTART	FEh	No

## Notes:

Cmd, is short for Command.

Prot, is short for commands that are protected with security mask.

### Mechanical Information - Hole Mount, Open Frame Version

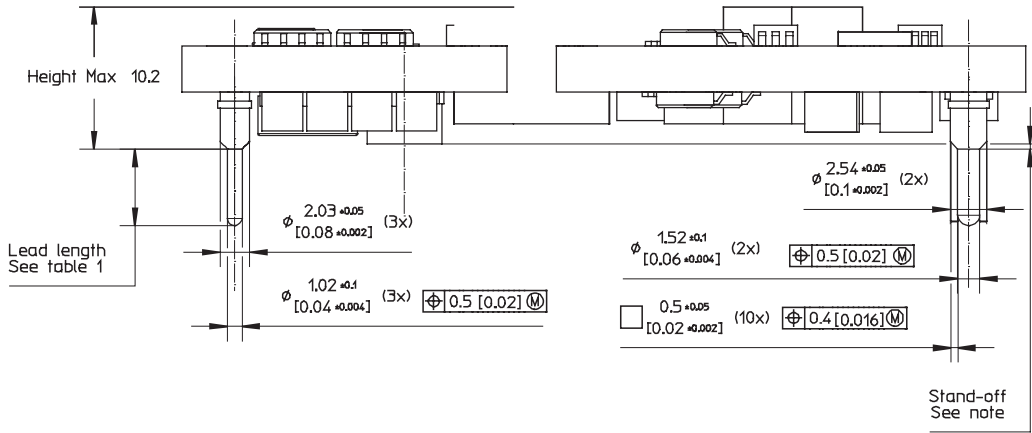

X1	Lead length
0	5.33 [0.210]
2	3.69 [0.145] (cut)
3	4.57 [0.180] (cut)
4	2.79 [0.110] (cut)

TOP VIEW

Pin positions according to recommended footprint

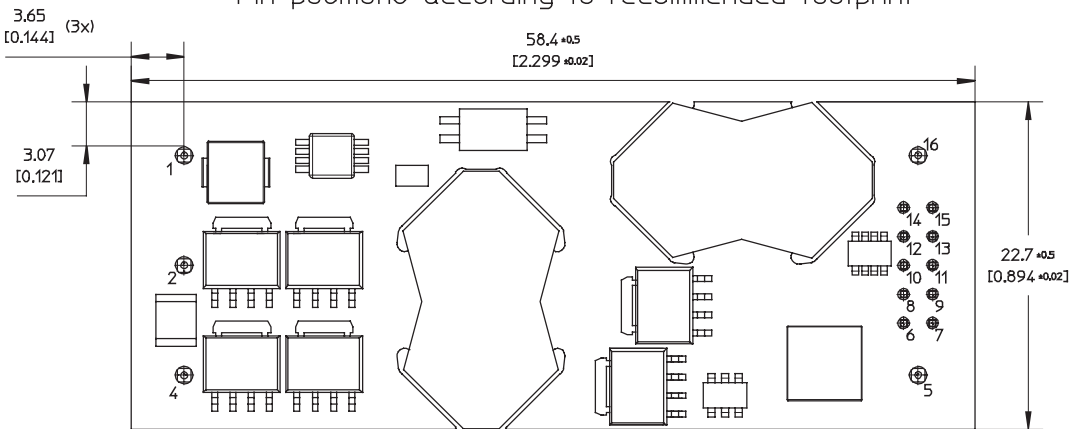

RECOMMENDED FOOTPRINT - TOP VIEW

Table 1.  
X1 = Ordering information

**PIN SPECIFICATIONS**  
 Pin 1-5 & 16 Material: Copper alloy  
 Plating: Min Au 0.1  $\mu$ m over 1-3  $\mu$ m Ni.  
 Pin 5-14 Material: Brass  
 Plating: Min Au 0.2  $\mu$ m over 1.3  $\mu$ m Ni.

**NOTE**  
 Pin 6-15 are optional and only used if digital communication is required.

Stand-off to none conductive components min 0.15mm [0.006]  
 Stand-off to conductive components min 1.25mm [0.049]

Pin position 3 not present due to case to ground pin not available on BMR457

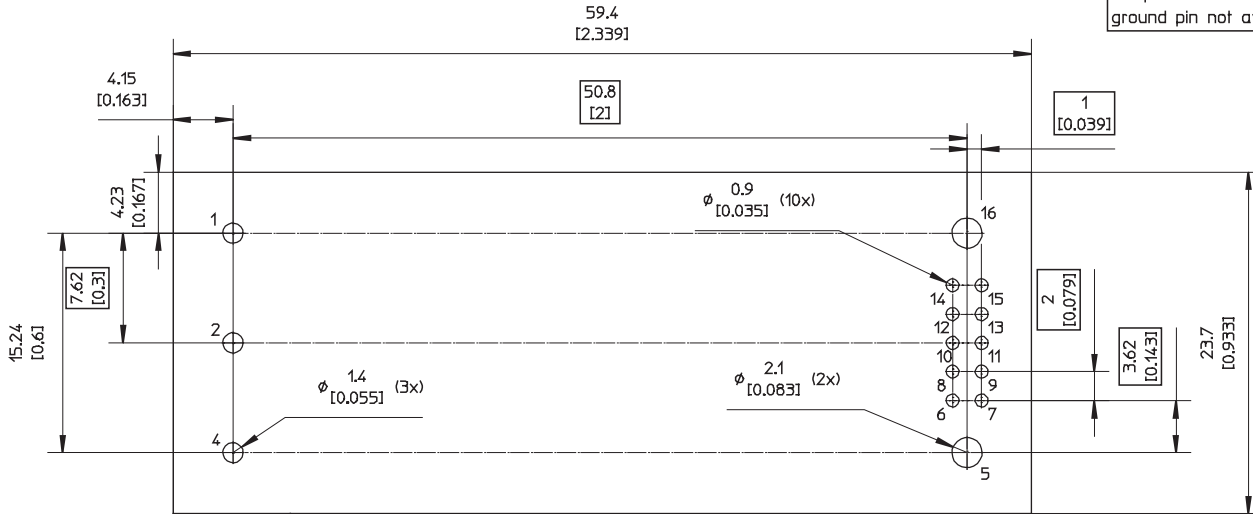

Recommended keep away area for user components.  
 The stand-off in combination with insulating material ensures that requirements as per IEC/EN/UL60950 are met and 2250 V isolation maintained even if open vias or traces are present under the DC/DC converter.

Weight: Typical 26 g  
 All dimensions in mm [inch]  
 Tolerances unless specified:  
 x.x  $\pm$ 0.50 [0.02], x.xx $\pm$ 0.25 [0.01]  
 (not applied on footprint or typical values)



### Mechanical Information - Hole Mount, Base Plate Version

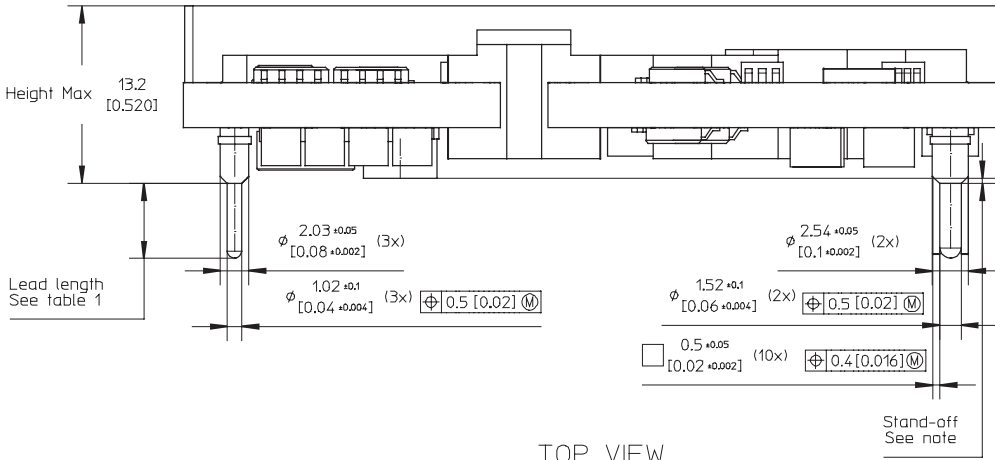

TOP VIEW  
Pin positions according to recommended footprint

X1	Lead length
0	5.33 [0.210]
2	3.69 [0.145] (cut)
3	4.57 [0.180] (cut)
4	2.79 [0.110] (cut)

Table 1.  
X1= Ordering information

CASE  
Material: Aluminium  
For screw attachment apply mounting torque of max 0.44 Nm [3.9 lbf in].  
M3 screws must not protrude more than 2.7 mm [0.106] into the base plate.

PIN SPECIFICATIONS  
Pin 1-5 & 16 Material: Copper alloy  
Plating: Min Au 0.1 µm over 1-3 µm Ni.  
Pin 6-15 Material: Brass  
Plating: Min Au 0.2 µm over 1.3 µm Ni.

NOTE  
Pin 6-15 are optional and only used if digital communication is required.

Stand-off to none conductive components min 0.15mm [0.006]  
Stand-off to conductive components min 1.25mm [0.049]

Pin position 3 not present due to case to ground pin not available on BMR457

Weight: Typical: 38 g  
All dimensions in mm [inch]  
Tolerances unless specified:  
x.x ±0.50 [0.02]  
x.xx±0.25 [0.01]  
(not applied on footprint or typical values)

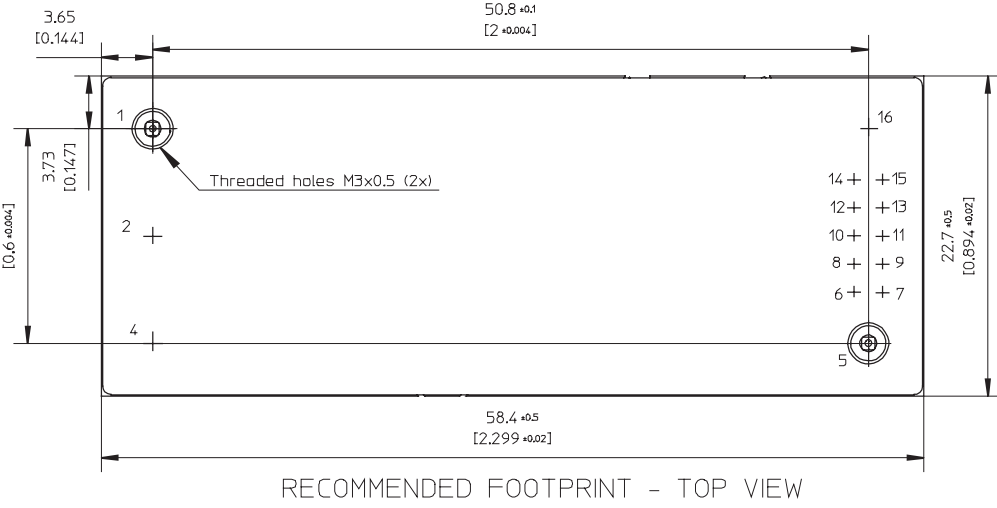

RECOMMENDED FOOTPRINT - TOP VIEW

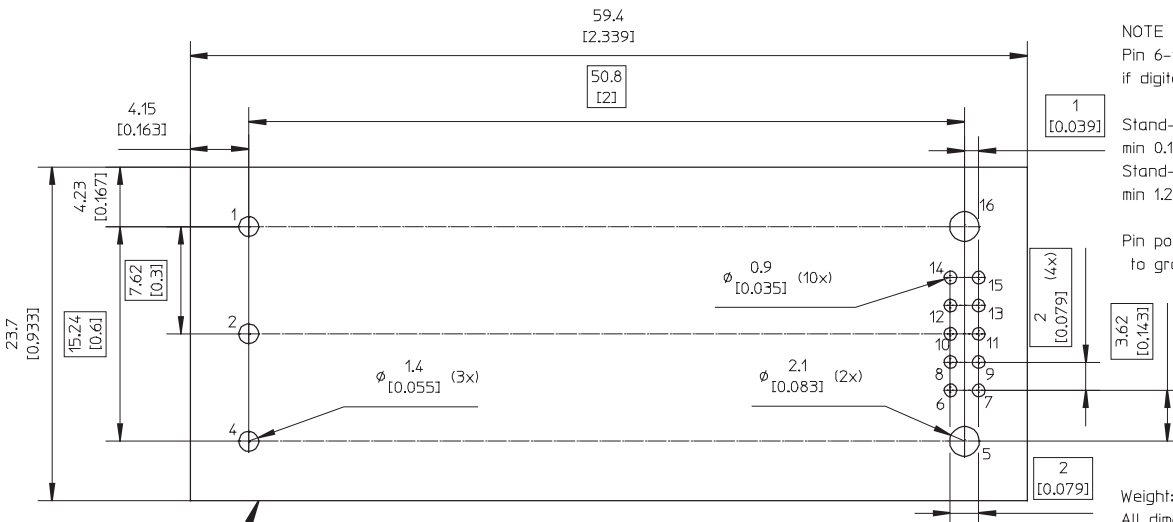

Recommended keep away area for user components.  
The stand-off in combination with insulating material ensures that requirements as per IEC/EN/UL60950 are met and 2250 V isolation maintained even if open vias or traces are present under the DC/DC converter.

### Mechanical Information - Surface Mount Version

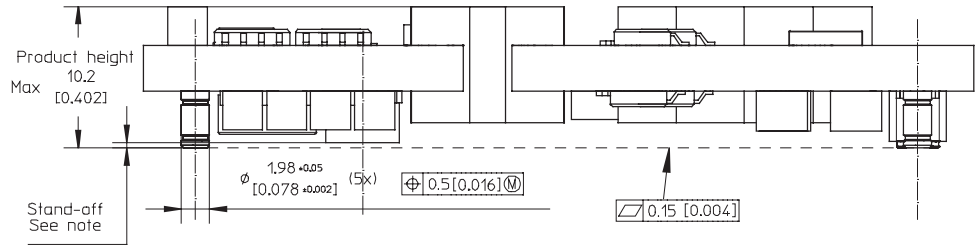
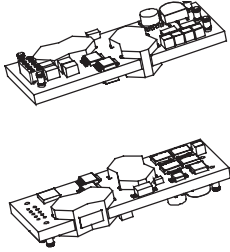

TOP VIEW

Pin positions according to recommended footprint

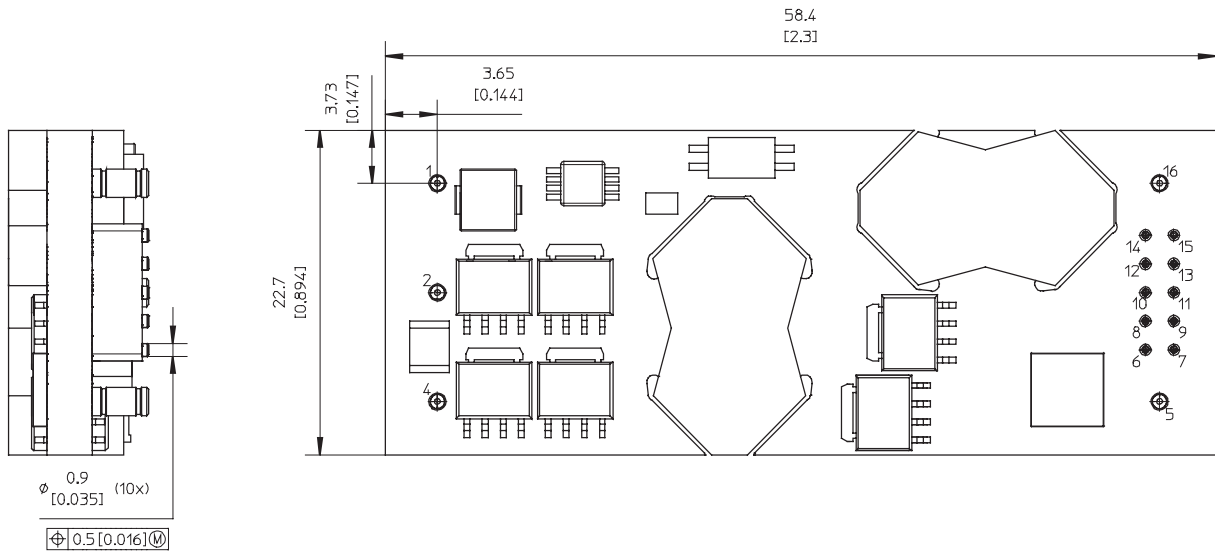

RECOMMENDED FOOTPRINT - TOP VIEW

**NOTES**

**PIN SPECIFICATIONS**

- Pin 1-5 & 16 Material: Copper alloy
- Plating: Min Au 0.1  $\mu\text{m}$  over 1-3  $\mu\text{m}$  Ni.
- Pin 6-15 Material: Brass
- Plating: Min Au 0.2  $\mu\text{m}$  over 1.3  $\mu\text{m}$  Ni.
- Pin 6-15 are optional and only used if digital communication is required.
- Pin position 3 not present due to case to ground pin not available on BMR457

- Stand-off to none conductive components min 0.15mm [0.006]
- Stand-off to conductive components min 1.25mm [0.049]

Weight: Typical 24 g

- All dimensions in mm [inch].
- Tolerances unless specified:
- x.x  $\pm 0.5$  [0.02]
- x.xx  $\pm 0.25$  [0.01]
- (not applied on footprint or typical values)

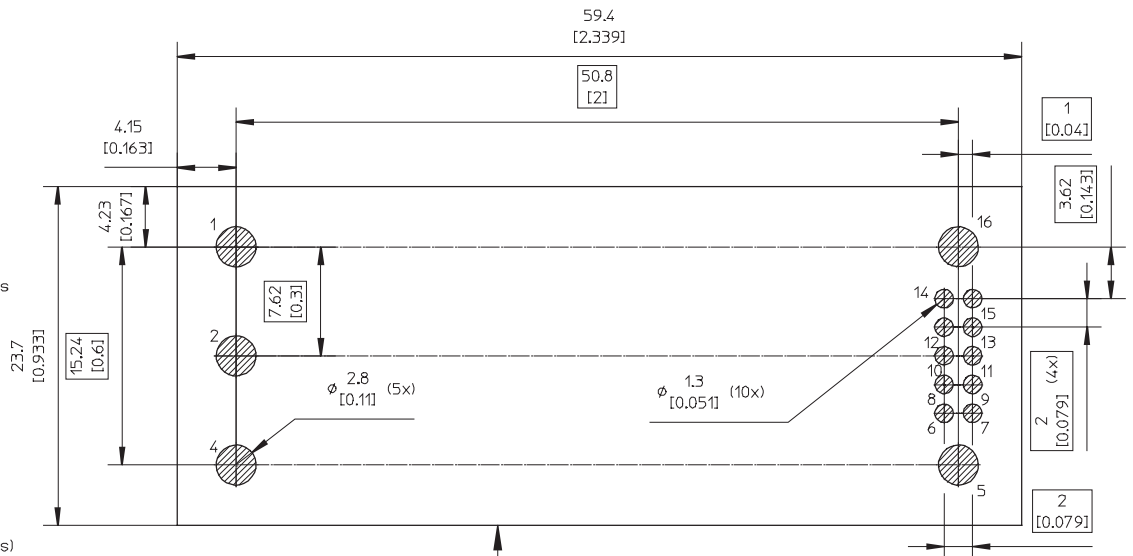

Recommended keep away area for user components.  
The stand-off in combination with insulating material ensures that requirements as per IEC/EN/UL60950 are met and 2250 V isolation maintained even if open vias or traces are present under the DC/DC converter.



## Soldering Information - Surface Mounting

The surface mount product is intended for forced convection or vapor phase reflow soldering in SnPb and Pb-free processes.

The reflow profile should be optimised to avoid excessive heating of the product. It is recommended to have a sufficiently extended preheat time to ensure an even temperature across the host PWB and it is also recommended to minimize the time in reflow.

A no-clean flux is recommended to avoid entrapment of cleaning fluids in cavities inside the product or between the product and the host board, since cleaning residues may affect long time reliability and isolation voltage.

General reflow process specifications		SnPb eutectic	Pb-free
Average ramp-up ( $T_{PRODUCT}$ )		3°C/s max	3°C/s max
Typical solder melting (liquidus) temperature	$T_L$	183°C	221°C
Minimum reflow time above $T_L$		60 s	60 s
Minimum pin temperature	$T_{PIN}$	210°C	235°C
Peak product temperature	$T_{PRODUCT}$	225°C	260°C
Average ramp-down ( $T_{PRODUCT}$ )		6°C/s max	6°C/s max
Maximum time 25°C to peak		6 minutes	8 minutes

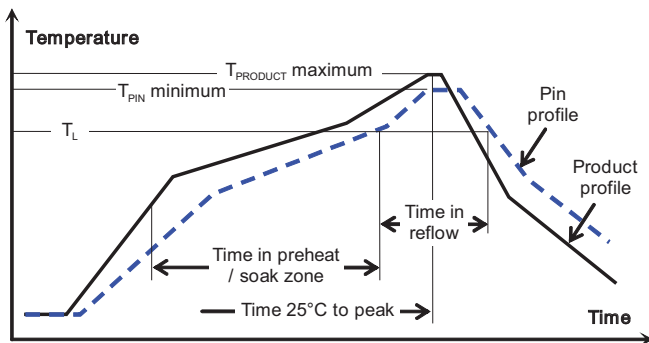

### Minimum Pin Temperature Recommendations

Pin number 5 chosen as reference location for the minimum pin temperature recommendation since this will likely be the coolest solder joint during the reflow process.

### SnPb solder processes

For SnPb solder processes, a pin temperature ( $T_{PIN}$ ) in excess of the solder melting temperature, ( $T_L$ , 183°C for Sn63Pb37) for more than 60 seconds and a peak temperature of 220°C is recommended to ensure a reliable solder joint.

For dry packed products only: depending on the type of solder paste and flux system used on the host board, up to a recommended maximum temperature of 245°C could be used, if the products are kept in a controlled environment (dry pack handling and storage) prior to assembly.

### Lead-free (Pb-free) solder processes

For Pb-free solder processes, a pin temperature ( $T_{PIN}$ ) in excess of the solder melting temperature ( $T_L$ , 217 to 221°C for SnAgCu solder alloys) for more than 60 seconds and a peak temperature of 245°C on all solder joints is recommended to ensure a reliable solder joint.

### Maximum Product Temperature Requirements

Top of the product PWB near pin 2 is chosen as reference location for the maximum (peak) allowed product temperature ( $T_{PRODUCT}$ ) since this will likely be the warmest part of the product during the reflow process.

### SnPb solder processes

For SnPb solder processes, the product is qualified for MSL 1 according to IPC/JEDEC standard J STD 020C.

During reflow  $T_{PRODUCT}$  must not exceed 225 °C at any time.

### Pb-free solder processes

For Pb-free solder processes, the product is qualified for MSL 3 according to IPC/JEDEC standard J-STD-020C.

During reflow  $T_{PRODUCT}$  must not exceed 260 °C at any time.

### Dry Pack Information

Products intended for Pb-free reflow soldering processes are delivered in standard moisture barrier bags according to IPC/JEDEC standard J STD 033 (Handling, packing, shipping and use of moisture/reflow sensitivity surface mount devices).

Using products in high temperature Pb-free soldering processes requires dry pack storage and handling. In case the products have been stored in an uncontrolled environment and no longer can be considered dry, the modules must be baked according to J STD 033.

### Thermocoupler Attachment

Top of PWB near pin 2 for measurement of maximum product temperature,  $T_{PRODUCT}$

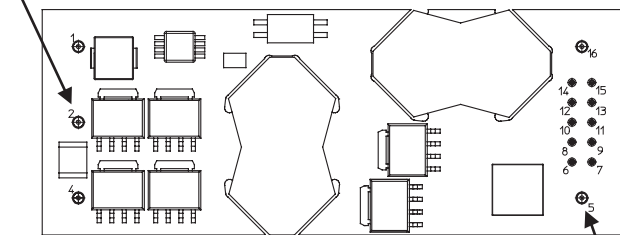

Pin 5 for measurement of minimum pin (solder joint) temperature,  $T_{PIN}$



### Soldering Information - Hole Mounting

The hole mounted product is intended for plated through hole mounting by wave or manual soldering. The pin temperature is specified to maximum to 270°C for maximum 10 seconds.

A maximum preheat rate of 4°C/s and maximum preheat temperature of 150°C is suggested. When soldering by hand, care should be taken to avoid direct contact between the hot soldering iron tip and the pins for more than a few seconds in order to prevent overheating.

A no-clean flux is recommended to avoid entrapment of cleaning fluids in cavities inside the product or between the product and the host board. The cleaning residues may affect long time reliability and isolation voltage.

### Delivery Package Information

The products are delivered in antistatic injection molded trays (Jedec design guide 4.10D standard) and in antistatic trays

Tray Specifications – SMD / Pin in paste	
Material	Antistatic PPE
Surface resistance	$10^5 < \text{Ohm/square} < 10^{12}$
Bakability	The trays can be baked at maximum 125°C for 48 hours
Tray thickness	17.40 mm 0.685 [inch]
Box capacity	100 products (5 full trays/box)
Tray weight	125 g empty, 605 g full tray

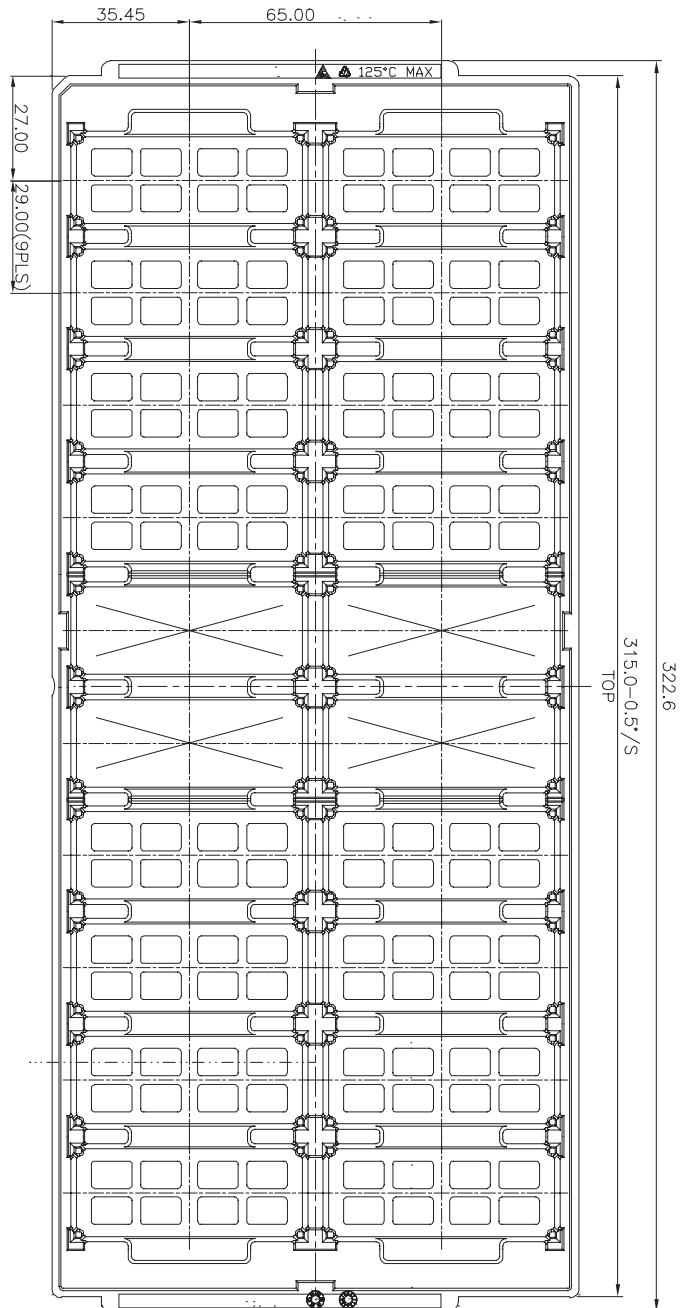

JEDEC standard tray for 2x5 = 10 products.  
 All dimensions in mm [inch]  
 Tolerances: X.x ±0.26 [0.01], X.xx ±0.13 [0.005]  
 Note: pick up positions refer to center of pocket.  
 See mechanical drawing for exact location on product.

<b>Tray Specifications - Through hole Version</b>	
<b>Material</b>	PE Foam, dissipative
<b>Surface resistance</b>	$10^5 < \text{Ohm/square} < 10^{12}$
<b>Bakability</b>	The trays are not bakeable
<b>Tray capacity</b>	25 converters/tray
<b>Box capacity</b>	75 products (3 full trays/box)
<b>Weight</b>	Product – Open frame 790 g full tray, 140g empty tray Product – Base plate option 1090 g full tray, 140 g empty tray

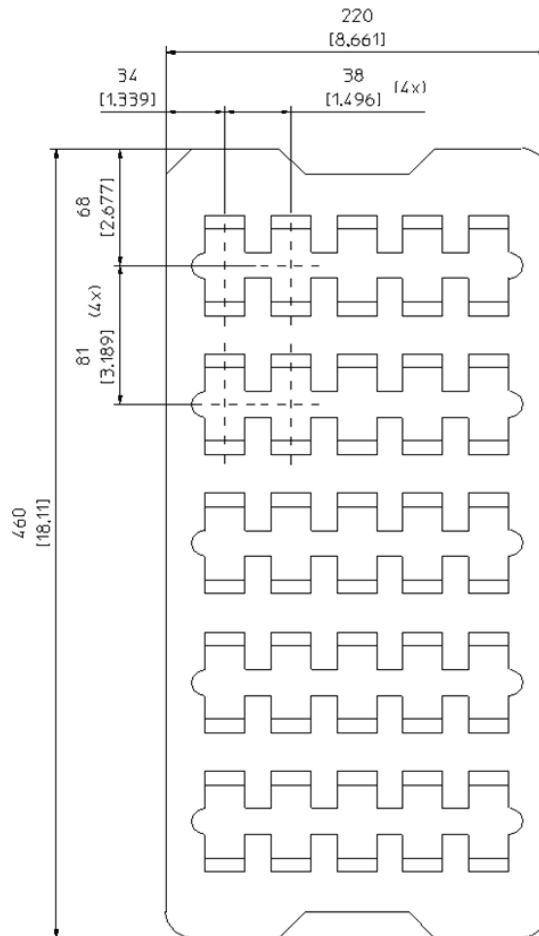

## Product Qualification Specification

Characteristics			
External visual inspection	IPC-A-610		
Change of temperature (Temperature cycling)	IEC 60068-2-14 Na	Temperature range Number of cycles Dwell/transfer time	-40 to 100°C 500 15 min/0-1 min
Cold (in operation)	IEC 60068-2-1 Ad	Temperature T <sub>A</sub> Duration	-45°C 72 h
Damp heat	IEC 60068-2-67 Cy	Temperature Humidity Duration	85°C 85 % RH 1000 hours
Dry heat	IEC 60068-2-2 Bd	Temperature Duration	125°C 1000 h
Electrostatic discharge susceptibility	IEC 61340-3-1, JESD 22-A114 IEC 61340-3-2, JESD 22-A115	Human body model (HBM) Machine Model (MM)	Class 2, 2000 V Class 3, 200 V
Immersion in cleaning solvents	IEC 60068-2-45 XA, method 2	Water Glycol ether Isopropyl alcohol	55°C 35°C 35°C
Mechanical shock	IEC 60068-2-27 Ea	Peak acceleration Duration	100 g 6 ms
Moisture reflow sensitivity <sup>1</sup>	J-STD-020C	Level 1 (SnPb-eutectic) Level 3 (Pb Free)	225°C 260°C
Operational life test	MIL-STD-202G, method 108A	Duration	1000 h
Resistance to soldering heat <sup>2</sup>	IEC 60068-2-20 Tb, method 1A	Solder temperature Duration	270°C 10-13 s
Robustness of terminations	IEC 60068-2-21 Test Ua1 IEC 60068-2-21 Test Ue1	Through hole mount products Surface mount products	All leads All leads
Solderability	IEC 60068-2-58 test Td <sup>1</sup>	Preconditioning Temperature, SnPb Eutectic Temperature, Pb-free	150°C dry bake 16 h 215°C 235°C
	IEC 60068-2-20 test Ta <sup>2</sup>	Preconditioning Temperature, SnPb Eutectic Temperature, Pb-free	Steam ageing 235°C 245°C
Vibration, broad band random	IEC 60068-2-64 Fh, method 1	Frequency Spectral density Duration	10 to 500 Hz 0.07 g <sup>2</sup> /Hz 10 min in each direction

Notes:

<sup>1</sup> Only for products intended for reflow soldering (surface mount products)<sup>2</sup> Only for products intended for wave soldering (plated through hole products)

## REVISION HISTORY

---

rev.	description	date
1.0	initial release	02/20/2013

The revision history provided is for informational purposes only and is believed to be accurate.



**Headquarters**  
20050 SW 112th Ave.  
Tualatin, OR 97062  
**800.275.4899**

Fax 503.612.2383  
**cui.com**  
techsupport@cui.com

Novum is a trademark of CUI.  
PMBus is a trademark of SMIF, Inc.  
All other trademarks are the property of their respective owners.

CUI offers a two (2) year limited warranty. Complete warranty information is listed on our website.

CUI reserves the right to make changes to the product at any time without notice. Information provided by CUI is believed to be accurate and reliable. However, no responsibility is assumed by CUI for its use, nor for any infringements of patents or other rights of third parties which may result from its use.

CUI products are not authorized or warranted for use as critical components in equipment that requires an extremely high level of reliability. A critical component is any component of a life support device or system whose failure to perform can be reasonably expected to cause the failure of the life support device or system, or to affect its safety or effectiveness.