

## FDD14AN06LA0\_F085

### N-Channel PowerTrench® MOSFET 60V, 50A, 14.6mΩ

#### Features

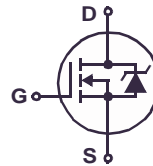
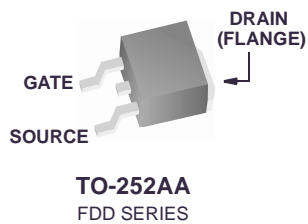
- $r_{DS(ON)} = 12.8m\Omega$  (Typ.),  $V_{GS} = 5V$ ,  $I_D = 50A$
- $Q_g(tot) = 25nC$  (Typ.),  $V_{GS} = 5V$
- Low Miller Charge
- Low  $Q_{RR}$  Body Diode
- UIS Capability (Single Pulse and Repetitive Pulse)
- Qualified to AEC Q101
- RoHS Compliant

#### Applications

- Motor / Body Load Control
- ABS Systems
- Powertrain Management
- Injection Systems
- DC-DC converters and Off-line UPS
- Distributed Power Architectures and VRMs
- Primary Switch for 12V and 24V systems



Formerly developmental type 83557



#### MOSFET Maximum Ratings $T_C = 25^\circ C$ unless otherwise noted

Symbol	Parameter	Ratings	Units
$V_{DSS}$	Drain to Source Voltage	60	V
$V_{GS}$	Gate to Source Voltage	$\pm 20$	V
$I_D$	Drain Current		
	Continuous ( $T_C < 100^\circ C$ , $V_{GS} = 10V$ )	50	A
	Continuous ( $T_C < 80^\circ C$ , $V_{GS} = 5V$ )	50	A
	Continuous ( $T_{amb} = 25^\circ C$ , $V_{GS} = 5V$ , with $R_{\theta JA} = 52^\circ C/W$ )	9.5	A
	Pulsed	Figure 4	A
$E_{AS}$	Single Pulse Avalanche Energy (Note 1)	55	mJ
$P_D$	Power dissipation	125	W
	Derate above $25^\circ C$	0.83	W/ $^\circ C$
$T_J, T_{STG}$	Operating and Storage Temperature	-55 to 175	$^\circ C$

#### Thermal Characteristics

$R_{\theta JC}$	Maximum Thermal Resistance Junction to Case TO-252	1.2	$^\circ C/W$
$R_{\theta JA}$	Maximum Thermal Resistance Junction to Ambient TO-252, 1in <sup>2</sup> copper pad area	52	$^\circ C/W$

This product has been designed to meet the extreme test conditions and environment demanded by the automotive industry. For a copy of the requirements, see AEC Q101 at: <http://www.aecouncil.com/>

Reliability data can be found at: <http://www.fairchildsemi.com/products/discrete/reliability/index.html>.

All Fairchild Semiconductor products are manufactured, assembled and tested under ISO9000 and QS9000 quality systems certification.

## Package Marking and Ordering Information

Device Marking	Device	Package	Reel Size	Tape Width	Quantity
FDD14AN06LA0	FDD14AN06LA0_F085	TO-252AA	330mm	16mm	2500 units

## Electrical Characteristics $T_C = 25^\circ\text{C}$ unless otherwise noted

Symbol	Parameter	Test Conditions	Min	Typ	Max	Units
$B_{VDSS}$	Drain to Source Breakdown Voltage	$I_D = 250\mu\text{A}$ , $V_{GS} = 0\text{V}$	60	-	-	V
$I_{DSS}$	Zero Gate Voltage Drain Current	$V_{DS} = 50\text{V}$ $V_{GS} = 0\text{V}$ $T_C = 150^\circ\text{C}$	-	-	1	$\mu\text{A}$
$I_{GSS}$	Gate to Source Leakage Current	$V_{GS} = \pm 20\text{V}$	-	-	$\pm 100$	nA

## On Characteristics

$V_{GS(TH)}$	Gate to Source Threshold Voltage	$V_{GS} = V_{DS}$ , $I_D = 250\mu\text{A}$	1	-	3	V
$r_{DS(ON)}$	Drain to Source On Resistance	$I_D = 50\text{A}$ , $V_{GS} = 10\text{V}$	-	0.0102	0.0116	$\Omega$
		$I_D = 50\text{A}$ , $V_{GS} = 5\text{V}$	-	0.0128	0.0146	
		$I_D = 50\text{A}$ , $V_{GS} = 5\text{V}$ , $T_J = 175^\circ\text{C}$	-	0.028	0.033	

## Dynamic Characteristics

$C_{ISS}$	Input Capacitance	$V_{DS} = 25\text{V}$ , $V_{GS} = 0\text{V}$ , $f = 1\text{MHz}$	-	2810	-	pF
$C_{OSS}$	Output Capacitance		-	270	-	pF
$C_{RSS}$	Reverse Transfer Capacitance		-	115	-	pF
$Q_{g(TOT)}$	Total Gate Charge at 5V	$V_{GS} = 0\text{V}$ to 5V	-	25	32	nC
$Q_{g(TH)}$	Threshold Gate Charge	$V_{GS} = 0\text{V}$ to 1V	-	2.7	3.5	nC
$Q_{gs}$	Gate to Source Gate Charge	$V_{DD} = 30\text{V}$ $I_D = 50\text{A}$ $I_g = 1.0\text{mA}$	-	9.7	-	nC
$Q_{gs2}$	Gate Charge Threshold to Plateau		-	7.0	-	nC
$Q_{gd}$	Gate to Drain "Miller" Charge		-	8.7	-	nC

## Switching Characteristics ( $V_{GS} = 5\text{V}$ )

$t_{ON}$	Turn-On Time	$V_{DD} = 30\text{V}$ , $I_D = 50\text{A}$ $V_{GS} = 5\text{V}$ , $R_{GS} = 5.1\Omega$	-	-	218	ns
$t_{d(ON)}$	Turn-On Delay Time		-	14	-	ns
$t_r$	Rise Time		-	132	-	ns
$t_{d(OFF)}$	Turn-Off Delay Time		-	27	-	ns
$t_f$	Fall Time		-	47	-	ns
$t_{OFF}$	Turn-Off Time		-	-	111	ns

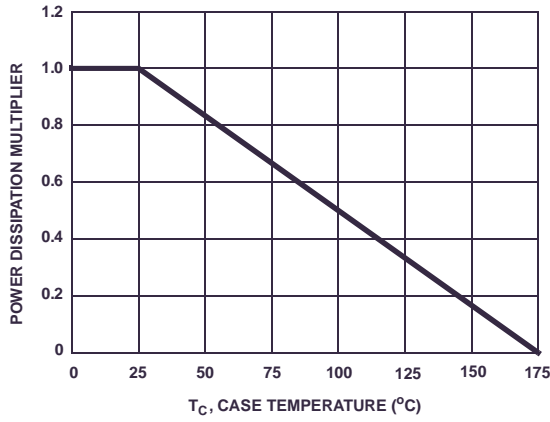
## Drain-Source Diode Characteristics

$V_{SD}$	Source to Drain Diode Voltage	$I_{SD} = 50\text{A}$	-	-	1.25	V
		$I_{SD} = 25\text{A}$	-	-	1.0	V
$t_{rr}$	Reverse Recovery Time	$I_{SD} = 50\text{A}$ , $dI_{SD}/dt = 100\text{A}/\mu\text{s}$	-	-	30	ns
$Q_{RR}$	Reverse Recovered Charge	$I_{SD} = 50\text{A}$ , $dI_{SD}/dt = 100\text{A}/\mu\text{s}$	-	-	24	nC

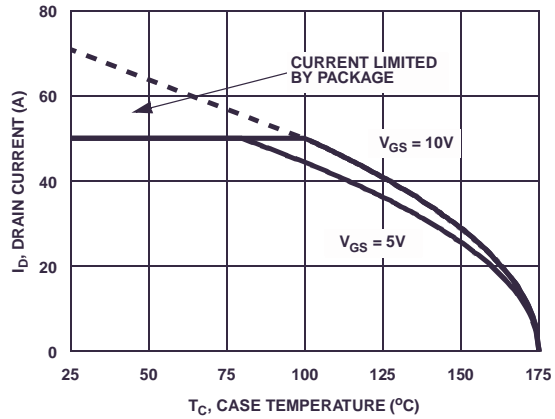
### Notes:

1: Starting  $T_J = 25^\circ\text{C}$ ,  $L = 70\mu\text{H}$ ,  $I_{AS} = 40\text{A}$ .

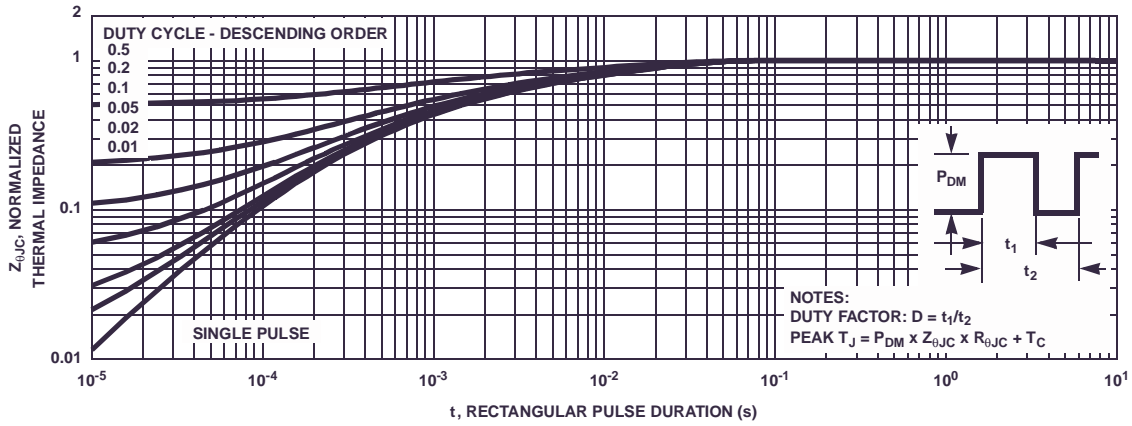
**Typical Characteristics**  $T_C = 25^\circ\text{C}$  unless otherwise noted



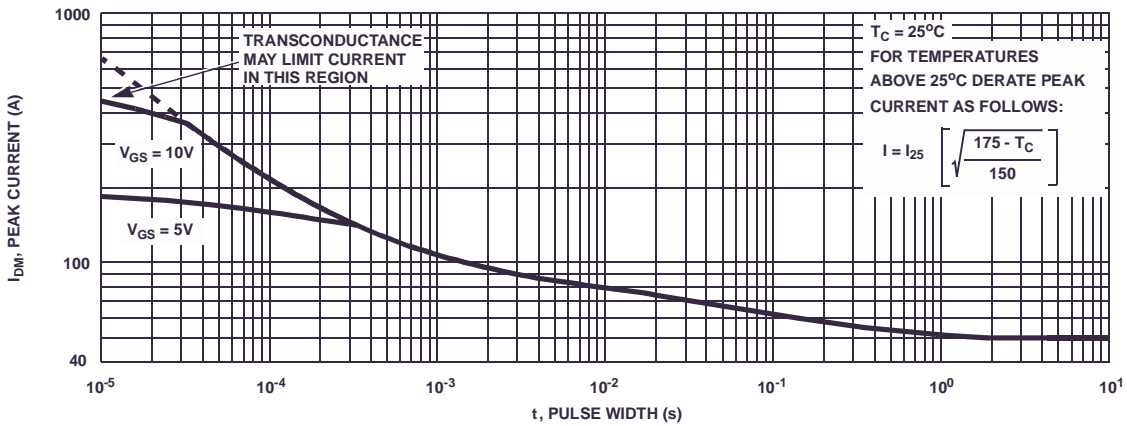
**Figure 1. Normalized Power Dissipation vs Ambient Temperature**



**Figure 2. Maximum Continuous Drain Current vs Case Temperature**

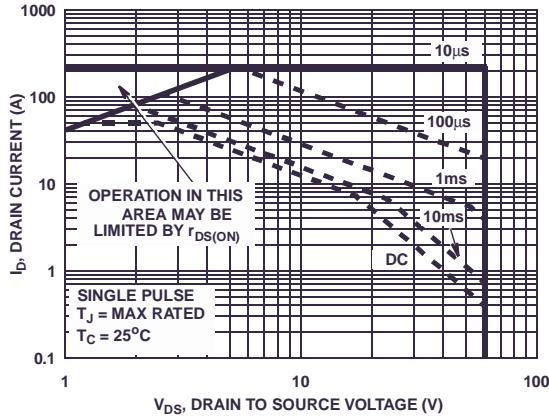


**Figure 3. Normalized Maximum Transient Thermal Impedance**

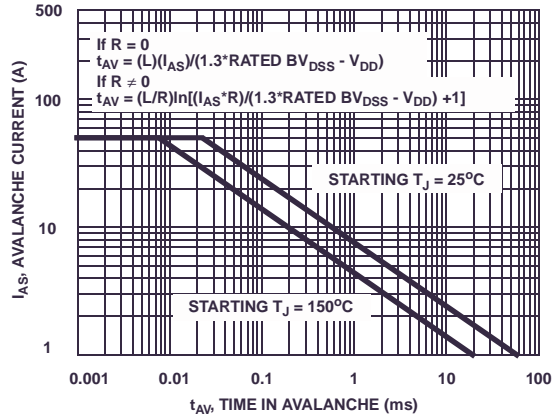


**Figure 4. Peak Current Capability**

**Typical Characteristics**  $T_C = 25^\circ\text{C}$  unless otherwise noted

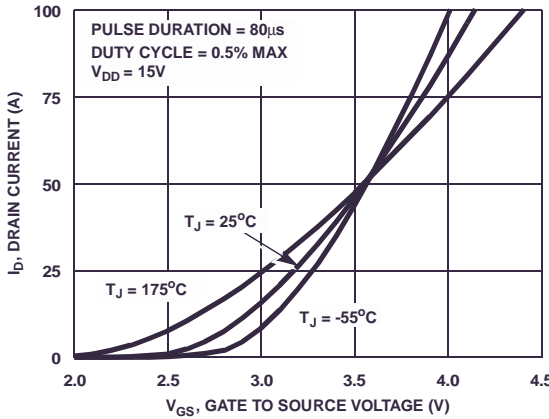


**Figure 5. Forward Bias Safe Operating Area**

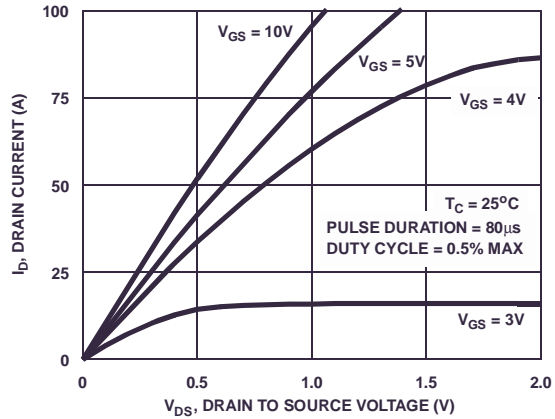


**Figure 6. Unclamped Inductive Switching Capability**

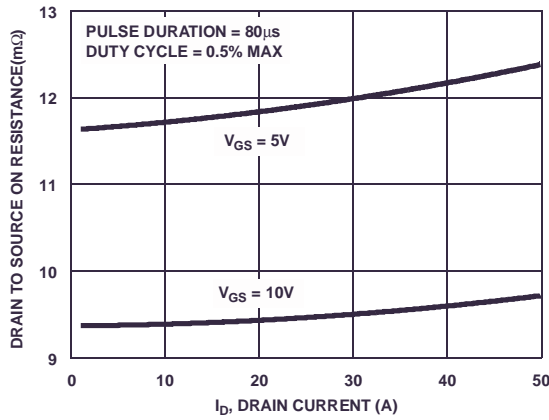
NOTE: Refer to Fairchild Application Notes AN7514 and AN7515



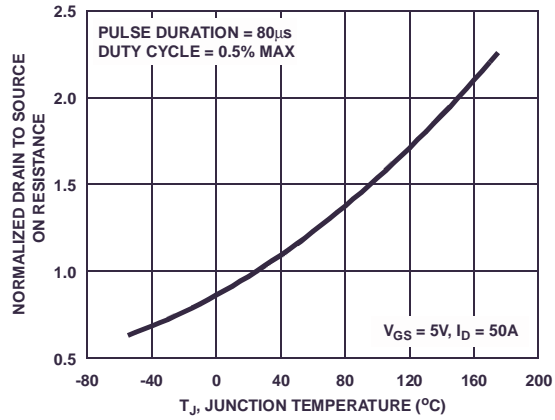
**Figure 7. Transfer Characteristics**



**Figure 8. Saturation Characteristics**

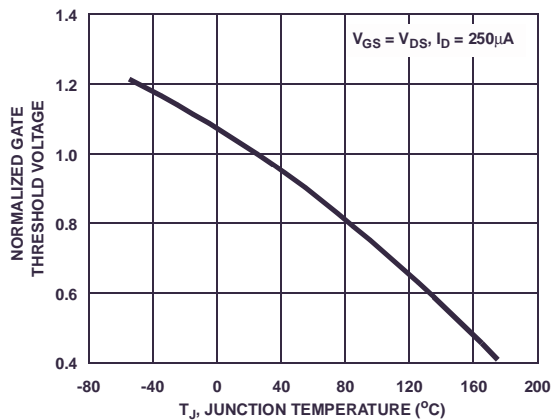


**Figure 9. Drain to Source On Resistance vs Drain Current**

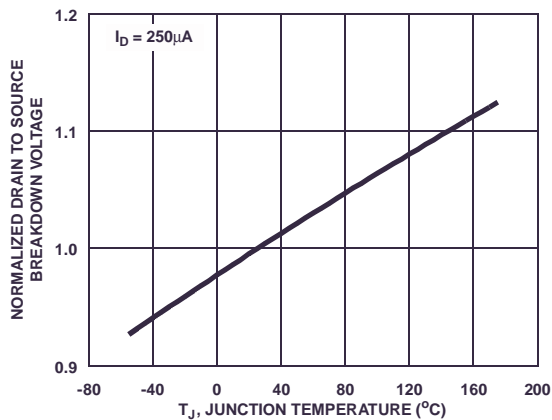


**Figure 10. Normalized Drain to Source On Resistance vs Junction Temperature**

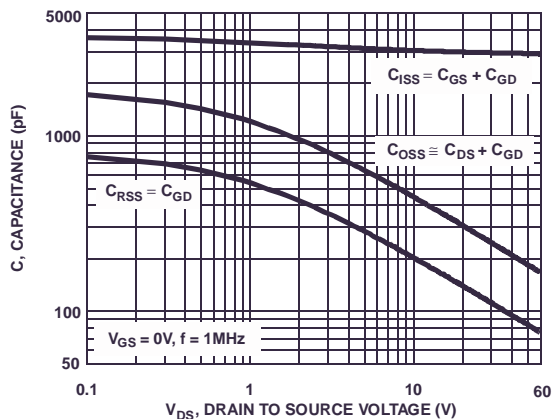
**Typical Characteristics**  $T_C = 25^\circ\text{C}$  unless otherwise noted



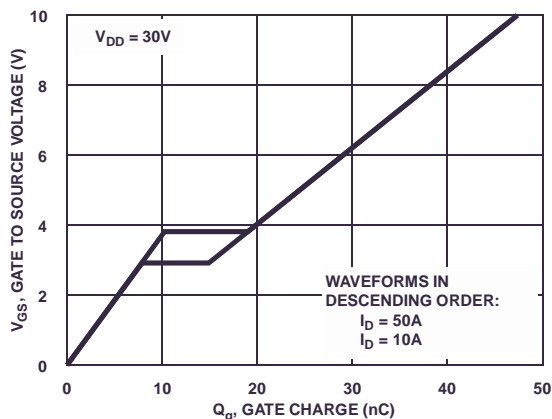
**Figure 11. Normalized Gate Threshold Voltage vs Junction Temperature**



**Figure 12. Normalized Drain to Source Breakdown Voltage vs Junction Temperature**



**Figure 13. Capacitance vs Drain to Source Voltage**



**Figure 14. Gate Charge Waveforms for Constant Gate Currents**

## Test Circuits and Waveforms

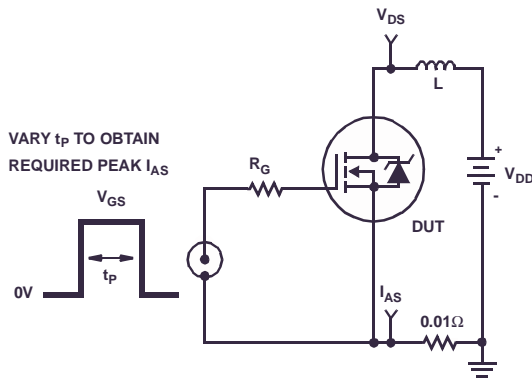


Figure 15. Unclamped Energy Test Circuit

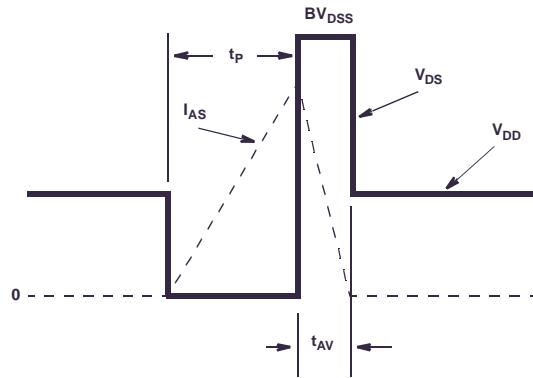


Figure 16. Unclamped Energy Waveforms

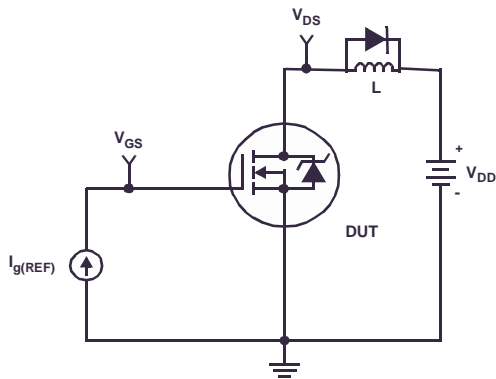


Figure 17. Gate Charge Test Circuit

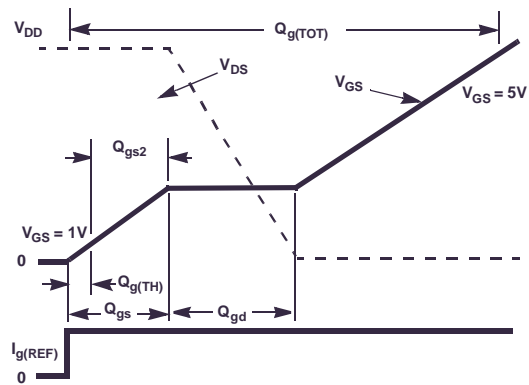


Figure 18. Gate Charge Waveforms

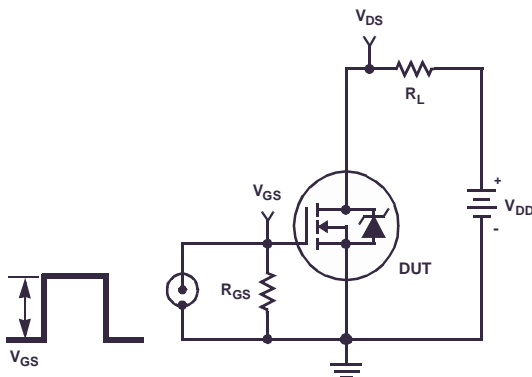


Figure 19. Switching Time Test Circuit

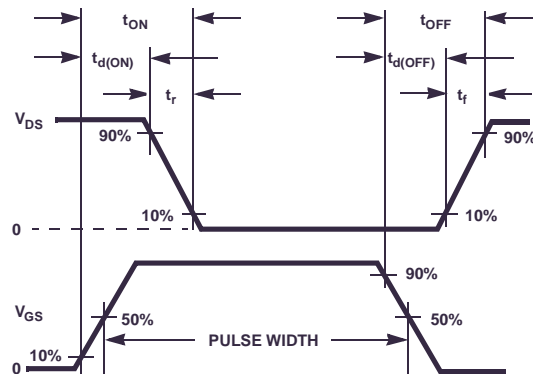


Figure 20. Switching Time Waveforms

### Thermal Resistance vs. Mounting Pad Area

The maximum rated junction temperature,  $T_{JM}$ , and the thermal resistance of the heat dissipating path determines the maximum allowable device power dissipation,  $P_{DM}$ , in an application. Therefore the application's ambient temperature,  $T_A$  ( $^{\circ}C$ ), and thermal resistance  $R_{\theta JA}$  ( $^{\circ}C/W$ ) must be reviewed to ensure that  $T_{JM}$  is never exceeded. Equation 1 mathematically represents the relationship and serves as the basis for establishing the rating of the part.

$$P_{DM} = \frac{(T_{JM} - T_A)}{R_{\theta JA}} \quad (\text{EQ. 1})$$

In using surface mount devices such as the TO-252 package, the environment in which it is applied will have a significant influence on the part's current and maximum power dissipation ratings. Precise determination of  $P_{DM}$  is complex and influenced by many factors:

1. Mounting pad area onto which the device is attached and whether there is copper on one side or both sides of the board.
2. The number of copper layers and the thickness of the board.
3. The use of external heat sinks.
4. The use of thermal vias.
5. Air flow and board orientation.
6. For non steady state applications, the pulse width, the duty cycle and the transient thermal response of the part, the board and the environment they are in.

Fairchild provides thermal information to assist the designer's preliminary application evaluation. Figure 21 defines the  $R_{\theta JA}$  for the device as a function of the top copper (component side) area. This is for a horizontally positioned FR-4 board with 1oz copper after 1000 seconds of steady state power with no air flow. This graph provides the necessary information for calculation of the steady state junction temperature or power dissipation. Pulse applications can be evaluated using the Fairchild device Spice thermal model or manually utilizing the normalized maximum transient thermal impedance curve.

Thermal resistances corresponding to other copper areas can be obtained from Figure 21 or by calculation using Equation 2 or 3. Equation 2 is used for copper area defined in inches square and equation 3 is for area in centimeters square. The area, in square inches or square centimeters is the top copper area including the gate and source pads.

$$R_{\theta JA} = 33.32 + \frac{23.84}{(0.268 + Area)} \quad (\text{EQ. 2})$$

Area in Inches Squared

$$R_{\theta JA} = 33.32 + \frac{154}{(1.73 + Area)} \quad (\text{EQ. 3})$$

Area in Centimeters Squared

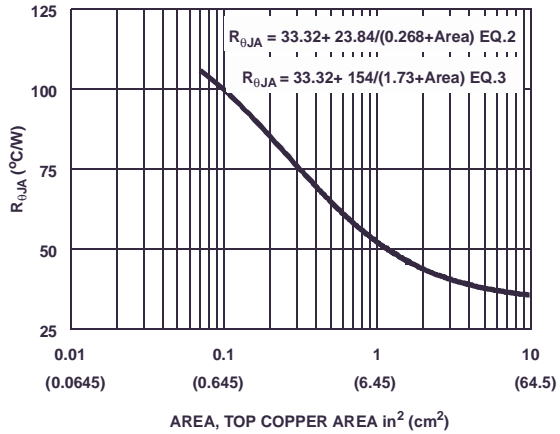


Figure 21. Thermal Resistance vs Mounting Pad Area





## SABER Electrical Model

REV January 2004

template FDD14AN06LA0 n2,n1,n3

electrical n2,n1,n3

{

var i iscl

dp..model dbodymod = (isl=15e-12,rs=3.2e-3,nl=1.05,trs1=1.5e-3,trs2=1e-6,cjo=10e-10,tt=1.5e-8,m=0.58,ikf=15.00,xti=3)

dp..model dbreakmod = (rs=1e-1,trs1=1.12e-3,trs2=1.25e-6)

dp..model dplcapmod = (cjo=80e-11,isl=10e-30,nl=10,m=0.57)

m..model mmedmod = (type=\_n,vto=2,kp=8,is=1e-30,tox=1)

m..model mstrongmod = (type=\_n,vto=2.45,kp=105,is=1e-30,tox=1)

m..model mweakmod = (type=\_n,vto=1.61,kp=0.04,is=1e-30,tox=1,rs=0.1)

sw\_vcsp..model s1amod = (ron=1e-5,roff=0.1,von=-4,voff=-3)

sw\_vcsp..model s1bmod = (ron=1e-5,roff=0.1,von=-3,voff=-4)

sw\_vcsp..model s2amod = (ron=1e-5,roff=0.1,von=-2.5,voff=-0.5)

sw\_vcsp..model s2bmod = (ron=1e-5,roff=0.1,von=-0.5,voff=-2.5)

c.ca n12 n8 = 1.5e-9

c.cb n15 n14 = 1.5e-9

c.cin n6 n8 = 28.5e-10

dp.dbody n7 n5 = model=dbodymod

dp.dbreak n5 n11 = model=dbreakmod

dp.dplcap n10 n5 = model=dplcapmod

spe.ebreak n11 n7 n17 n18 = 64.8

spe.eds n14 n8 n5 n8 = 1

spe.egs n13 n8 n6 n8 = 1

spe.esg n6 n10 n6 n8 = 1

spe.evthres n6 n21 n19 n8 = 1

spe.evtemp n20 n6 n18 n22 = 1

i.it n8 n17 = 1

l.lgate n1 n9 = 5e-9

l.ldrain n2 n5 = 1.00e-9

l.lsource n3 n7 = 2e-9

res.rlgate n1 n9 = 50

res.rldrain n2 n5 = 10

res.rlsource n3 n7 = 20

m.mmed n16 n6 n8 n8 = model=mmedmod, l=1u, w=1u

m.mstrong n16 n6 n8 n8 = model=mstrongmod, l=1u, w=1u

m.mweak n16 n21 n8 n8 = model=mweakmod, l=1u, w=1u

res.rbreak n17 n18 = 1, tc1=0.92e-3,tc2=-0.35e-6

res.rdrain n50 n16 = 4.2e-3, tc1=7.92e-3,tc2=3.4e-5

res.rgate n9 n20 = 2.7

res.rslc1 n5 n51 = 1e-6, tc1=2.8e-3,tc2=1e-7

res.rslc2 n5 n50 = 1e3

res.rsource n8 n7 = 4e-3, tc1=4.0e-3,tc2=1e-6

res.rvthres n22 n8 = 1, tc1=-2.5e-3,tc2=-1e-5

res.rvtemp n18 n19 = 1, tc1=-2.3e-3,tc2=1.5e-6

sw\_vcsp.s1a n6 n12 n13 n8 = model=s1amod

sw\_vcsp.s1b n13 n12 n13 n8 = model=s1bmod

sw\_vcsp.s2a n6 n15 n14 n13 = model=s2amod

sw\_vcsp.s2b n13 n15 n14 n13 = model=s2bmod

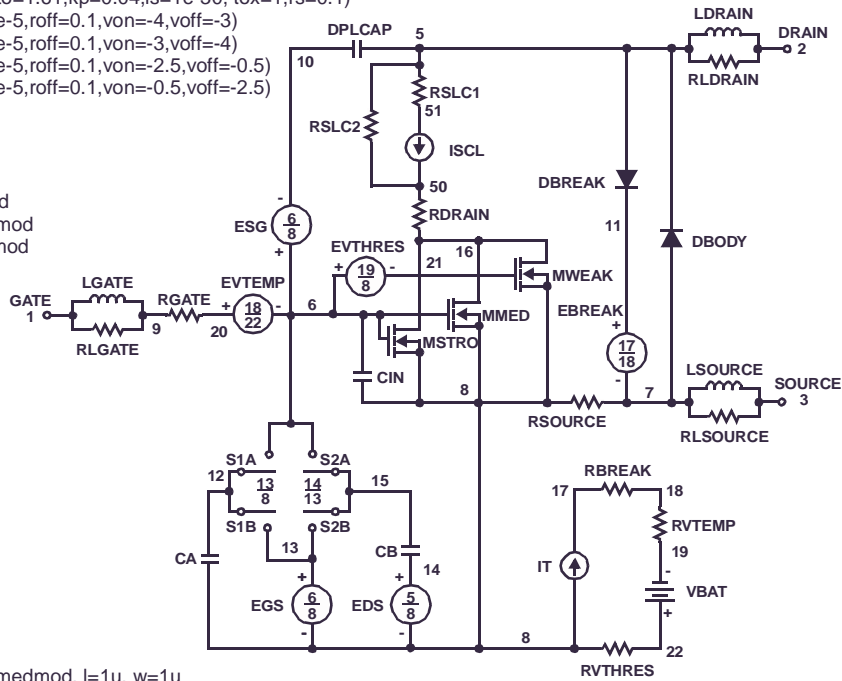
v.vbat n22 n19 = dc=1

equations {

i (n51->n50) +=iscl

iscl: v(n51,n50) = (((n5,n51)/(1e-9+abs(v(n5,n51))))\*((abs(v(n5,n51))\*1e6/200)\*\* 3))

}



FDD14AN06LA0\_F085 N-Channel PowerTrench<sup>®</sup> MOSFET

### SPICE Thermal Model

REV January 2004  
FDD14AN06LA0T

CTHERM1 TH 6 2.5e-3  
CTHERM2 6 5 3e-3  
CTHERM3 5 4 4e-3  
CTHERM4 4 3 7e-3  
CTHERM5 3 2 8.2e-3  
CTHERM6 2 TL 5e-2

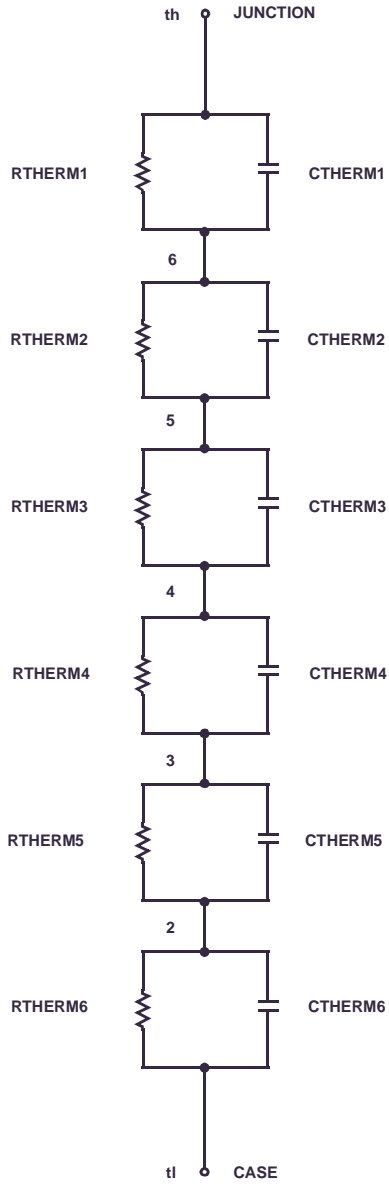
RTHERM1 TH 6 4.2e-2  
RTHERM2 6 5 8.4e-2  
RTHERM3 5 4 1.04e-1  
RTHERM4 4 3 1.14e-1  
RTHERM5 3 2 2.74e-1  
RTHERM6 2 TL 3.44e-1

### SABER Thermal Model

SABER thermal model FDD14AN06LA0T  
template thermal\_model th tl  
thermal\_c th, tl

```
{
  ctherm.ctherm1 th 6 =2.5e-3
  ctherm.ctherm2 6 5 =3e-3
  ctherm.ctherm3 5 4 =4e-3
  ctherm.ctherm4 4 3 =7e-3
  ctherm.ctherm5 3 2 =8.2e-3
  ctherm.ctherm6 2 tl =5e-2
```





```
rtherm.rtherm1 th 6 =4.2e-2
rtherm.rtherm2 6 5 =8.4e-2
rtherm.rtherm3 5 4 =1.04e-1
rtherm.rtherm4 4 3 =1.14e-1
rtherm.rtherm5 3 2 =2.74e-1
rtherm.rtherm6 2 tl =3.44e-1
}
```





**TRADEMARKS**

The following includes registered and unregistered trademarks and service marks, owned by Fairchild Semiconductor and/or its global subsidiaries, and is not intended to be an exhaustive list of all such trademarks.

- |                          |   |   |   |
|--------------------------|---|---|---|
| AccuPower™               | F-PFS™  | PowerTrench®  | The Power Franchise®  |
| Auto-SPM™                | FRFET®  | PowerXS™  | The Right Technology for Your Success™  |
| Build it Now™            | Global Power Resource <sup>SM</sup>   | Programmable Active Droop™  |   |
| CorePLUS™                | Green FPS™  | QFET®   | <b>power</b><br>franchise   |
| CorePOWER™               | Green FPS™ e-Series™  | QS™   | TinyBoost™  |
| CROSSVOLT™               | Gmax™   | Quiet Series™   | TinyBuck™   |
| CTL™                     | GTO™  | RapidConfigure™   | TinyCalc™   |
| Current Transfer Logic™  | IntelliMAX™   |  | TinyLogic®  |
| DEUXPEED®                | ISOPLANAR™  | Saving our world, 1mW/W/kW at a time™   | TINYOPTO™   |
| Dual Cool™               | MegaBuck™   | SignalWise™   | TinyPower™  |
| EcoSPARK®                | MICROCOUPLER™   | SmartMax™   | TinyPWM™  |
| EfficientMax™            | MicroFET™   | SMART START™  | TinyWire™   |
| ESBC™                    | MicroPak™   | SPM®  | TriFault Detect™  |
| <b>F</b> ®               | MicroPak2™  | STEALTH™  | TRUECURRENT™*   |
| Fairchild®               | MillerDrive™  | SuperFET®   | µSerDes™  |
| Fairchild Semiconductor® | MotionMax™  | SuperSOT™-3   |  |
| FACT Quiet Series™       | Motion-SPM™   | SuperSOT™-6   | UHC®  |
| FACT®                    | OptiHiT™  | SuperSOT™-8   | Ultra FRFET™  |
| FAST®                    | OPTOLOGIC®  | SupreMOS®   | UniFET™   |
| FastvCore™               | OPTOPLANAR®   | SyncFET™  | VCX™  |
| FETBench™                |  | Sync-Lock™  | VisualMax™  |
| FlashWriter® *           | PDP SPM™  |  | XS™   |
| FPS™                     | Power-SPM™  |   |   |

\*Trademarks of System General Corporation, used under license by Fairchild Semiconductor.

**DISCLAIMER**

FAIRCHILD SEMICONDUCTOR RESERVES THE RIGHT TO MAKE CHANGES WITHOUT FURTHER NOTICE TO ANY PRODUCTS HEREIN TO IMPROVE RELIABILITY, FUNCTION, OR DESIGN. FAIRCHILD DOES NOT ASSUME ANY LIABILITY ARISING OUT OF THE APPLICATION OR USE OF ANY PRODUCT OR CIRCUIT DESCRIBED HEREIN; NEITHER DOES IT CONVEY ANY LICENSE UNDER ITS PATENT RIGHTS, NOR THE RIGHTS OF OTHERS. THESE SPECIFICATIONS DO NOT EXPAND THE TERMS OF FAIRCHILD'S WORLDWIDE TERMS AND CONDITIONS, SPECIFICALLY THE WARRANTY THEREIN, WHICH COVERS THESE PRODUCTS.

**LIFE SUPPORT POLICY**

FAIRCHILD'S PRODUCTS ARE NOT AUTHORIZED FOR USE AS CRITICAL COMPONENTS IN LIFE SUPPORT DEVICES OR SYSTEMS WITHOUT THE EXPRESS WRITTEN APPROVAL OF FAIRCHILD SEMICONDUCTOR CORPORATION.

As used here in:

- Life support devices or systems are devices or systems which, (a) are intended for surgical implant into the body or (b) support or sustain life, and (c) whose failure to perform when properly used in accordance with instructions for use provided in the labeling, can be reasonably expected to result in a significant injury of the user.
- A critical component in any component of a life support, device, or system whose failure to perform can be reasonably expected to cause the failure of the life support device or system, or to affect its safety or effectiveness.

**ANTI-COUNTERFEITING POLICY**

Fairchild Semiconductor Corporation's Anti-Counterfeiting Policy. Fairchild's Anti-Counterfeiting Policy is also stated on our external website, [www.fairchildsemi.com](http://www.fairchildsemi.com), under Sales Support.

Counterfeiting of semiconductor parts is a growing problem in the industry. All manufactures of semiconductor products are experiencing counterfeiting of their parts. Customers who inadvertently purchase counterfeit parts experience many problems such as loss of brand reputation, substandard performance, failed application, and increased cost of production and manufacturing delays. Fairchild is taking strong measures to protect ourselves and our customers from the proliferation of counterfeit parts. Fairchild strongly encourages customers to purchase Fairchild parts either directly from Fairchild or from Authorized Fairchild Distributors who are listed by country on our web page cited above. Products customers buy either from Fairchild directly or from Authorized Fairchild Distributors are genuine parts, have full traceability, meet Fairchild's quality standards for handling and storage and provide access to Fairchild's full range of up-to-date technical and product information. Fairchild and our Authorized Distributors will stand behind all warranties and will appropriately address and warranty issues that may arise. Fairchild will not provide any warranty coverage or other assistance for parts bought from Unauthorized Sources. Fairchild is committed to combat this global problem and encourage our customers to do their part in stopping this practice by buying direct or from authorized distributors.

**PRODUCT STATUS DEFINITIONS**  
Definition of Terms

Datasheet Identification	Product Status	Definition
Advance Information	Formative / In Design	Datasheet contains the design specifications for product development. Specifications may change in any manner without notice.
Preliminary	First Production	Datasheet contains preliminary data; supplementary data will be published at a later date. Fairchild Semiconductor reserves the right to make changes at any time without notice to improve design.
No Identification Needed	Full Production	Datasheet contains final specifications. Fairchild Semiconductor reserves the right to make changes at any time without notice to improve the design.
Obsolete	Not In Production	Datasheet contains specifications on a product that is discontinued by Fairchild Semiconductor. The datasheet is for reference information only.