

RS7206

300mA CMOS LDO Linear Regulator with Enable

General Description

The RS7206 is a 4-Low (Low-dropout, Low-quiescent Current, Low-noise, Low-cost) linear regulator with ON/OFF control. The device operates in the input voltage range from +2.2V to +7.0V and delivers 300mA output current.

The high-accuracy output voltage is preset at an internally trimmed voltage 1.2V, 1.5V, 1.8V, 2.5V, 2.8V, 3.0V or 3.3V. Other output voltages can be mask-optioned from 1.2V to 5.0V with 100mV increment.

The RS7206 consists of a 1.0V reference compare amplifier, a P-channel pass transistor, and an enable/disable logic circuit. Other features include short-circuit protection, and thermal shutdown protection.

The RS7206 is also compatible with low ESR ceramic capacitors which give added output stability. This stability can be maintained even during load fluctuations due to the excellent transient response of the chip. The RS7206 devices are available in SOT-25 and VSON-6 (2x2) packages.

Features

- Operating Voltage Range : +2.2V to +7.0V
- Output Voltages : +1.2V to +5.0V with 100mV
- Dropout Voltage : 160mV@150mA
- Low Current Consumption 15µA (Typ.)
- Shutdown Current : 0.1µA (Typ.)
- ±2% Output Voltage Accuracy (special ±1% highly accurate)
- Low ESR Capacitor Compatible
- High Ripple Rejection : 70dB
- Output Current Limit Protection (450mA)
- Short Circuit Protection (150mA)
- Thermal Overload Shutdown Protection
- Control Output ON/OFF Function
- SOT-25 and VSON-6 (2x2) Packages
- RoHS Compliant and 100% Lead (Pb)-Free and Green (Halogen Free with Commercial Standard)

Applications

- Battery-powered equipment
- Voltage regulator for microprocessor
- Voltage regulator for LAN cards
- Wireless Communication equipment
- Audio/Video equipment
- Post Regulator for Switching Power
- Home Electric/Electronic Appliance
- CDMA/GSM Cellular Handsets
- Laptop, Palmtops, Notebook Computers
- Portable Information Application

Application Circuits

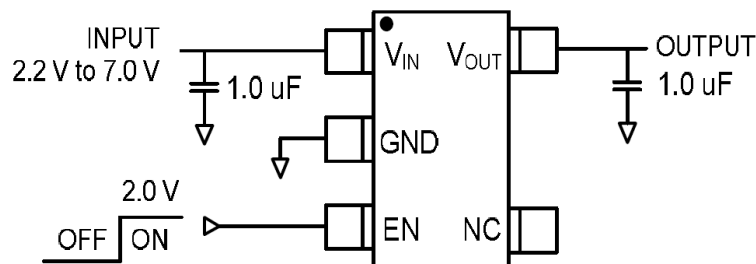

This integrated circuit can be damaged by ESD. Orister Corporation recommends that all integrated circuits be handled with appropriate precautions. Failure to observe proper handling and installation procedures can cause damage.

ESD damage can range from subtle performance degradation to complete device failure. Precision integrated circuits may be more susceptible to damage because very small parametric changes could cause the device not to meet its published specifications.

Pin Assignment

SOT-25

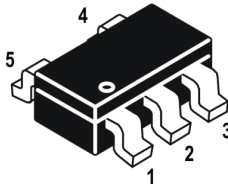

VSON-6 (2x2)

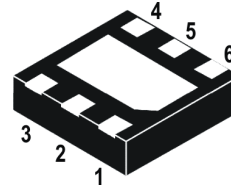

PACKAGE	PIN	SYMBOL	DESCRIPTION
SOT-25	1	VIN	Regulator Input Pin
	2	GND	Ground Pin
	3	EN	Chip Enable Pin
	4	NC	No Connection
	5	VOUT	Regulator Output Pin

PACKAGE	PIN	SYMBOL	DESCRIPTION
VSON-6 (2x2)	1	VOUT	Regulator Output Pin
	2, 5	NC	No Connection
	3, EP	GND	Ground Pin
	4	EN	Chip Enable Pin
	6	VIN	Regulator Input Pin

Ordering Information

DEVICE	DEVICE CODE
RS7206-XX YY Z	<p>XX is nominal output voltage (for example, 15 = 1.5V, 33 = 3.3V, 285 = 2.85V). YY is package designator : NE : SOT-25 VF : VSON-6 (2x2) Z is Lead Free designator : P: Commercial Standard, Lead (Pb) Free and Phosphorous (P) Free Package G: Green (Halogen Free with Commercial Standard)</p>

Block Diagram

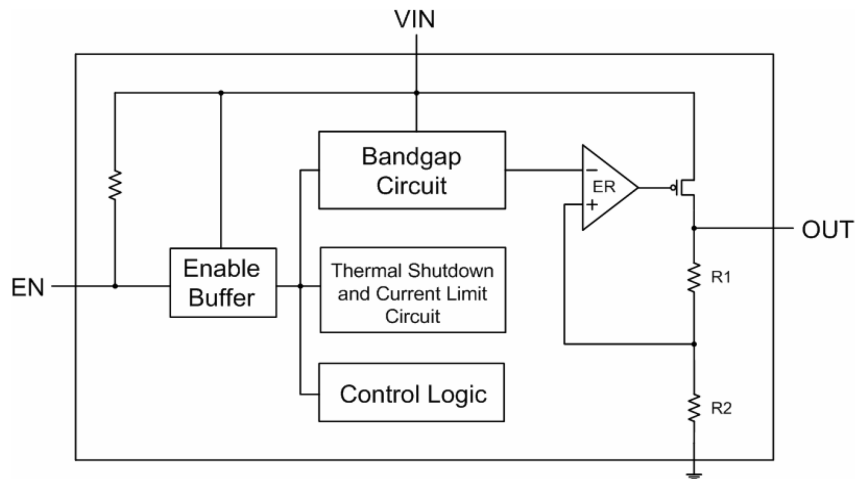

Absolute Maximum Ratings

Parameter		Symbol	Ratings	Units
Input Voltage V_{IN} to GND		V_{IN}	7.0	V
Output Current Limit, I_{LIMIT}		I_{LIMIT}	0.5	A
Junction Temperature		T_J	+155	°C
Thermal Resistance	SOT-25	θ_{JA}	250	°C/W
Power Dissipation	SOT-25	P_D	400	mW
	VSON-6 (2x2)		500	
Operating Ambient Temperature		T_{OPR}	-40 ~ +125	°C
Storage Temperature		T_{STG}	-55~+150	°C
Lead Temperature (soldering, 10sec)		-	+260	°C

NOTES :

- 1 The power dissipation values are based on the condition that junction temperature T_J and ambient temperature T_A difference is 100°C.
- 2 Stresses beyond those listed under “absolute maximum ratings” may cause permanent damage to the device. These are stress ratings only, and function operation of the device at these or any other conditions beyond those indicated under “recommended operating conditions” is not implied. Exposure to absolute-maximum –rated conditions for extended periods may affect device reliability.
- 3 The power dissipation of VSON-6 (2x2) would be 500mW normally with the 0.5X0.5 square inches cooper area connected to the bottom pad. However, it could be up to 1000mW with larger cooper area.

Electrical Characteristics ($V_{IN}=5V$, $T_A=25^\circ C$, unless otherwise specified)

Symbol	Parameter	Conditions	Min.	Typ.	Max.	Unit
V_{IN}	Input Voltage	-	2.2	-	7.0	V
V_{OUT}	Output Voltage	$V_{IN} = V_{OUT} + 0.8V$	-2%	V_{OUT}	+2%	V
I_{MAX}	Output Current (see NOTE 1)	$V_{OUT} + 0.8V \leq V_{IN} \leq 7.0V$, $2.2V \leq V_{IN}$	300	-	-	mA
V_{DROP}	Dropout Voltage	$I_{OUT} = 150mA$, $2.8V \leq V_{IN}$	-	160	180	mV
ΔV_{LINE}	Line Regulation	$V_{OUT} + 0.5V \leq V_{IN} \leq 7V$, $I_{OUT} = 1mA$	-	0.2	0.3	%V
		$V_{OUT} + 0.15V \leq V_{IN} \leq 5V$, $I_{OUT} = 1mA$, $V_{IN} \geq 2.8V$	-	-	0.2	
ΔV_{LOAD}	Load Regulation	$V_{IN} = V_{OUT} + 1V$, $1mA \leq I_{OUT} \leq 100mA$	-	0.01	0.02	%/mA
I_Q	Ground Pin Current	$V_{IN} = 5V$, $EN = 5V$, No Load	-	15	30	uA
		$V_{IN} = 5V$, $EN = 5V$, $I_{OUT} = 150mA$	-	30	60	
I_{SD}	Shutdown Current	$V_{IN} = V_{OUT} + 1V$, $EN = 0V$, No Load	-	0.1	1.0	uA
V_{IH}	EN Pin Input Voltage “H”	(see NOTE 2,3)	2.0	-	-	V
V_{IL}	EN Pin Input Voltage “L”	(see NOTE 2)	-	-	0.3	V
I_{EN}	EN Pin Leakage Current	$V_{IN} = (V_{OUT} + 0.15)$ to 5V, $V_{EN} > V_{IH}$	-	0.1	0.15	uA
I_{SC}	Short Circuit Current	-	-	150	-	mA
PSRR	Ripple Rejection	$I_{OUT} = 30mA$, $F = 1KHz$	-	70	-	dB
		$I_{OUT} = 30mA$, $F = 10KHz$	-	65	-	
e_N	Output Noise	$I_{OUT} = 100mA$, $F = 1KHz$, $C_{OUT} = 10uF$	-	40	-	$\mu V_{(rms)}$
T_{SD}	Thermal Shutdown Temperature	-	-	150	-	°C
T_{HYS}	Thermal Shutdown Hysteresis	-	-	20	-	°C

NOTES :

- 1 Measured using a double sided board with 1”x 2” square inches of copper area connected to the GND pins for “heat spreading”.
- 2 EN pin input voltage must be always less than or equal to input voltage.
- 3 EN Pin with internal pull high resistor is about several hundreds of K Ω for RS7206 only.

Detail Description

The RS7206 is a low-dropout linear regulator. The device provides preset 2.5V, 2.85V and 3.3V output voltages for output current up to 150mA. Other mask options for special output voltages from 1.2V to 5.0V with 100mV increment are also available. As illustrated in function block diagram, it consists of a 1.0V reference, error amplifier, a P-channel pass transistor, an ON/OFF control logic and an internal feedback voltage divider.

The 1.0V band gap reference is connected to the error amplifier, which compares this reference with the feedback voltage and amplifies the voltage difference. If the feedback voltage is lower than the reference voltage, the pass-transistor gate is pulled lower, which allows more current to pass to the output pin and increases the output voltage. If the feedback voltage is too high, the pass transistor gate is pulled up to decrease the output voltage.

The output voltage is feed back through an internal resistive divider connected to V_{OUT} pin. Additional blocks include an output current limiter, thermal sensor, and shutdown logic.

Internal P-channel Pass Transistor

The RS7206 features a P-channel MOSFET pass transistor. Unlike similar designs using PNP pass transistors, P-channel MOSFETs require no base drive, which reduces quiescent current. PNP based regulators also waste considerable current in dropout when the pass transistor saturates, and use high base-drive currents under large loads. The RS7206 does not suffer from these problems and consumes only 15 μ A (Typ.) of current consumption under heavy loads as well as in dropout conditions.

Enable Function

EN pin starts and stops the regulator. When the EN pin is switched to the power off level, the operation of all internal circuit stops, the build-in P-channel MOSFET output transistor between pins V_{IN} and V_{OUT} is switched off, allowing current consumption to be drastically reduced. The V_{OUT} pin enters the GND level through the internal discharge path between V_{OUT} and GND pins.

Output Voltage Selection

The RS7206 output voltage is preset at an internally trimmed voltage 2.5V, 2.85V or 3.3V. The output voltage also can be mask-optional from 1.2V to 5.0V with 100mV increment by special order. The first two digits of part number suffix identify the output voltage (see Ordering Information). For example, the RS7206-33 has a preset 3.3V output voltage.

Current Limit

The RS7206 also includes a fold back current limiter. It monitors and controls the pass transistor's gate voltage, estimates the output current, and limits the output current within 0.5A.

Thermal Overload Protection

Thermal overload protection limits total power dissipation in the RS7206. When the junction temperature exceeds $T_J=+150^{\circ}\text{C}$, a thermal sensor turns off the pass transistor, allowing the IC to cool down. The thermal sensor turns the pass transistor on again after the junction temperature cools down by 20°C , resulting in a pulsed output during continuous thermal overload conditions.

Thermal overload protection is designed to protect the RS7206 in the event of fault conditions. For continuous operation, the absolute maximum operating junction temperature rating of $T_J=+125^{\circ}\text{C}$ should not be exceeded.

Operating Region and Power Dissipation

Maximum power dissipation of the RS7206 depends on the thermal resistance of the case and circuit board, the temperature difference between the die junction and ambient air, and the rate of airflow. The power dissipation across the devices is $P = I_{OUT} \times (V_{IN} - V_{OUT})$. The resulting maximum power dissipation is:

$$P_{MAX} = \frac{(T_J - T_A)}{\theta_{JC} + \theta_{CA}} = \frac{(T_J - T_A)}{\theta_{JA}}$$

Where $(T_J - T_A)$ is the temperature difference between the RS7206 die junction and the surrounding air, θ_{JC} is the thermal resistance of the package chosen, and θ_{CA} is the thermal resistance through the printed circuit board, copper traces and other materials to the surrounding air. For better heat-sinking, the copper area should be equally shared between the V_{IN} , V_{OUT} , and GND pins.

The thermal resistance θ_{JA} of SOT-25 package of RS7206 is 250°C/W. Based on a maximum operating junction temperature 125°C with an ambient of 25°C, the maximum power dissipation will be:

$$P_{MAX} = \frac{(T_J - T_A)}{\theta_{JC} + \theta_{CA}} = \frac{(125 - 25)}{250} = 0.40W$$

Thermal characteristics were measured using a double sided board with 1"x2" square inches of copper area connected to the GND pin for "heat spreading".

Dropout Voltage

A regulator's minimum input-output voltage differential, or dropout voltage, determines the lowest usable supply voltage. In battery-powered systems, this will determine the useful end-of-life battery voltage. The RS7206 use a P- channel MOSFET pass transistor, its dropout voltage is a function of drain-to-source on-resistance $R_{DS(ON)}$ multiplied by the load current.

$$V_{DROPOUT} = V_{IN} - V_{OUT} = R_{DS(ON)} \times I_{OUT}$$

Typical Operating Characteristics

(1) Output Voltage vs. Output Current

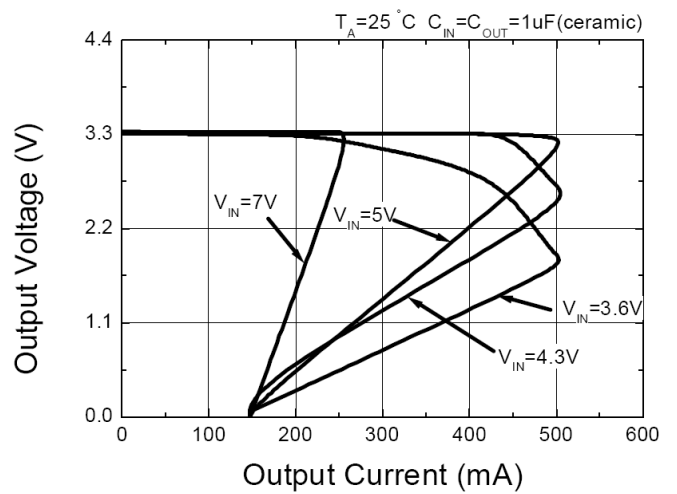
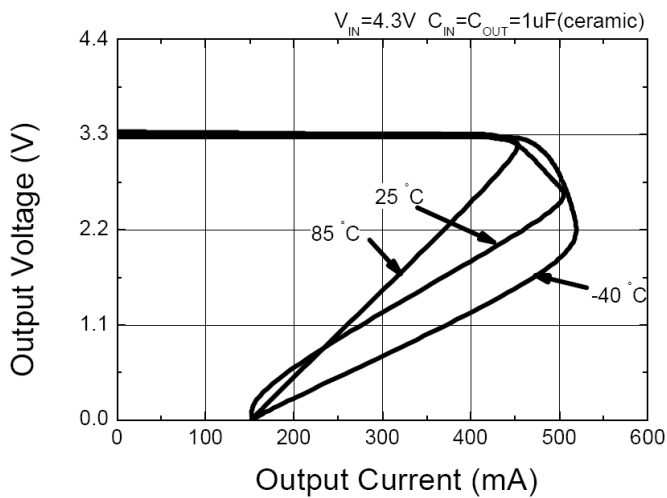
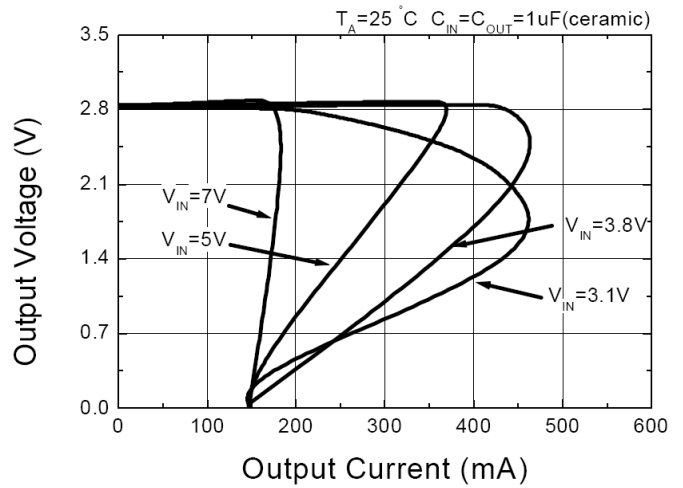
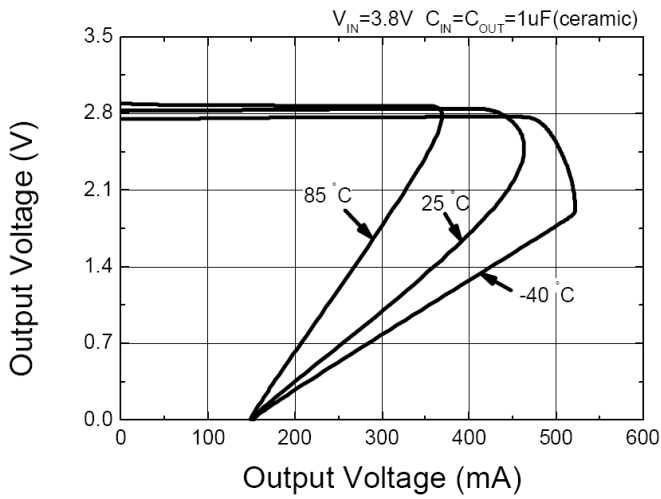
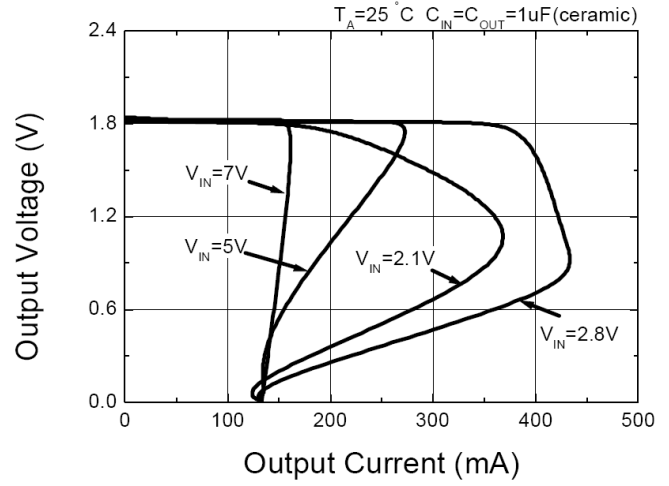
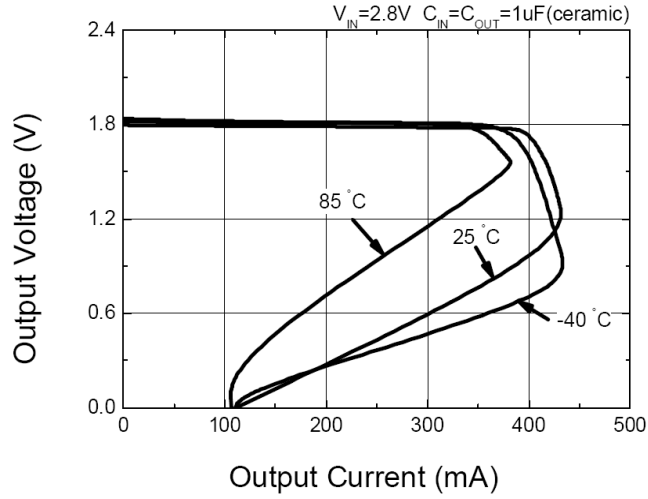

(1) Output Voltage vs. Output Current (Continued)

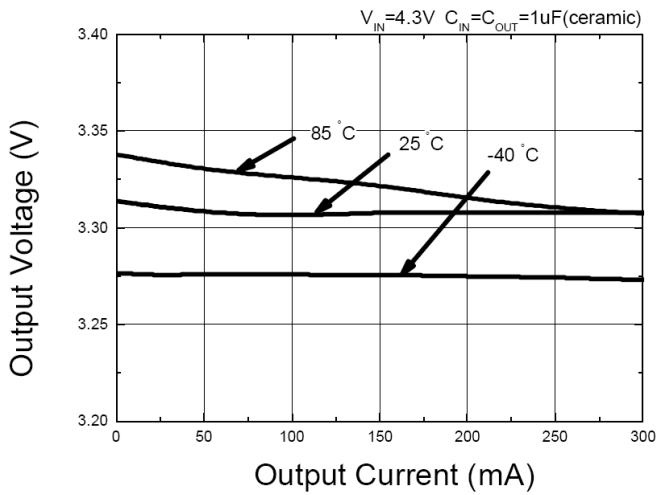
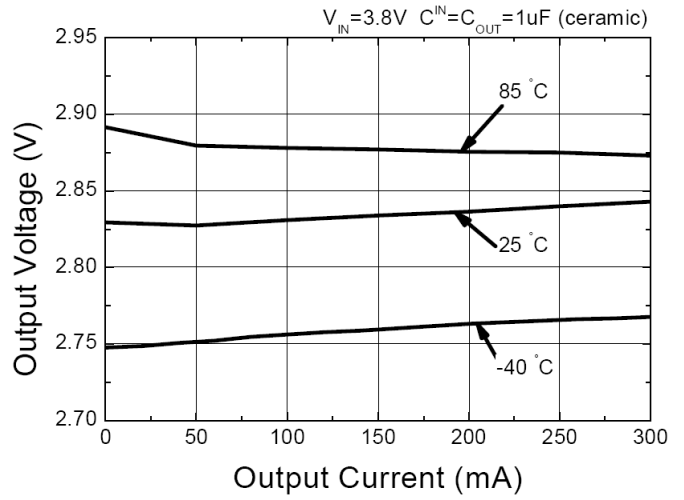
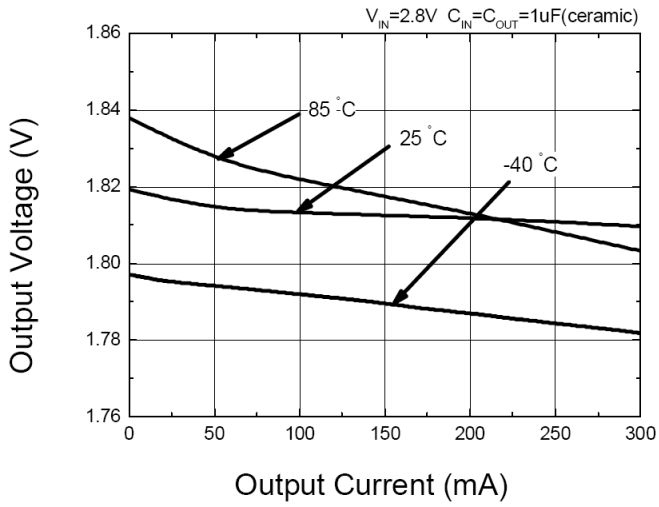

(2) Dropout Voltage vs. Output Current

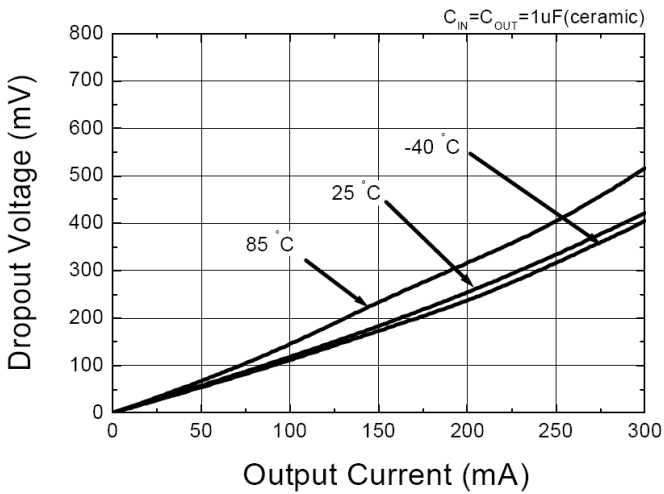
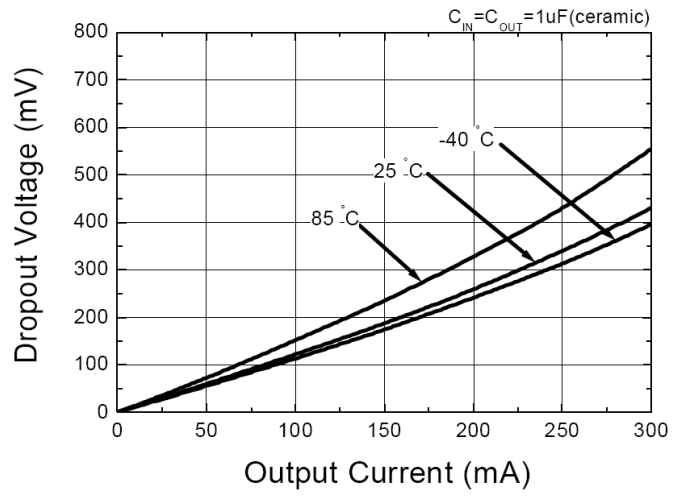
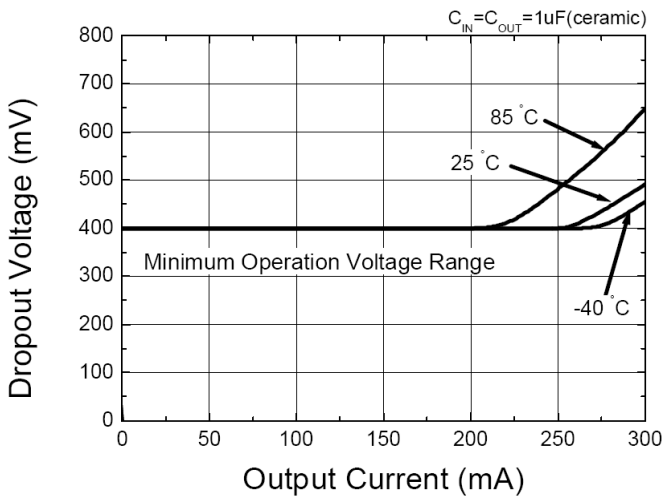

(3) Supply Current vs. Input Voltage

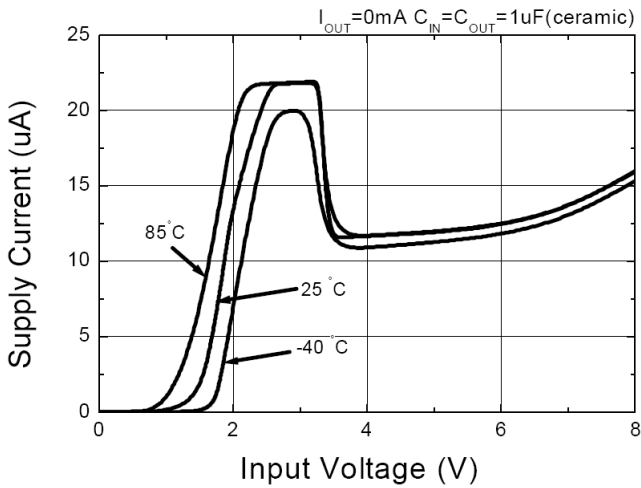
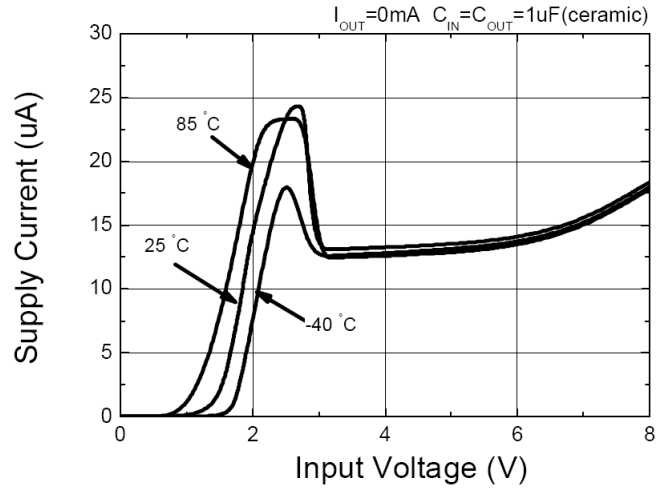
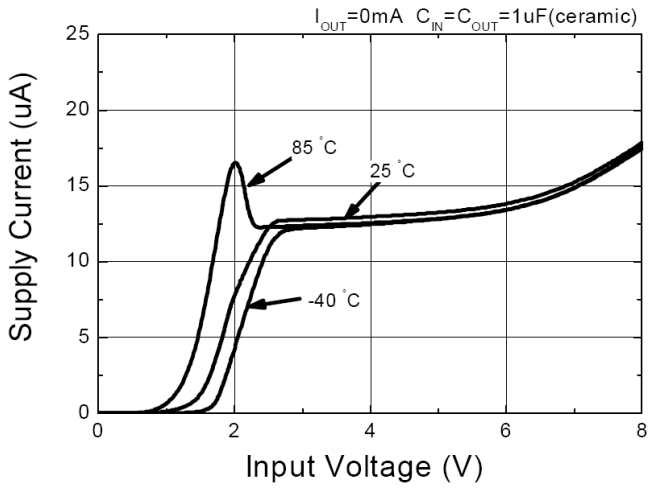

(4) Supply Current vs. Ambient Temperature

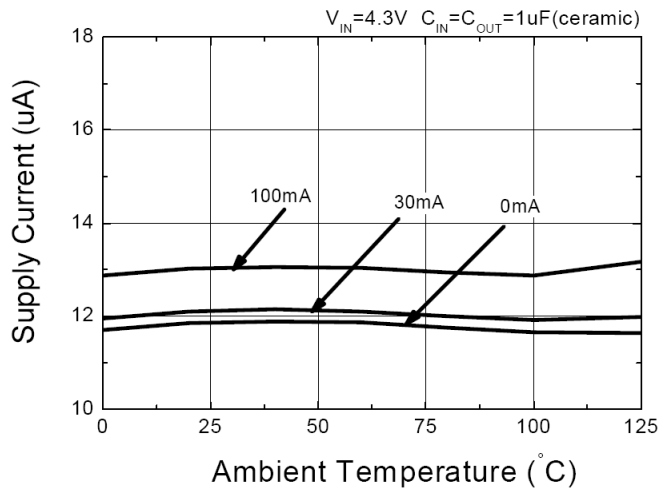
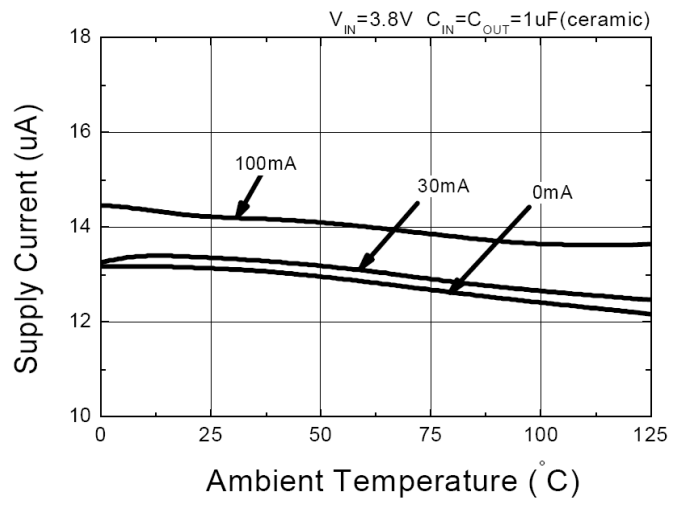
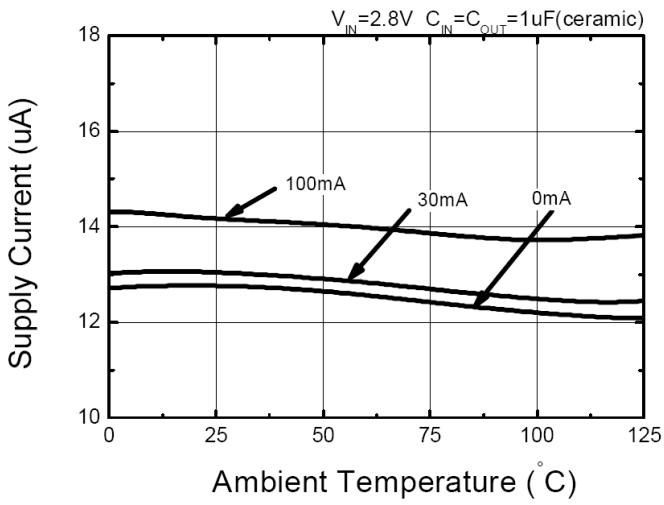

(5) Output Voltage vs. Ambient Temperature

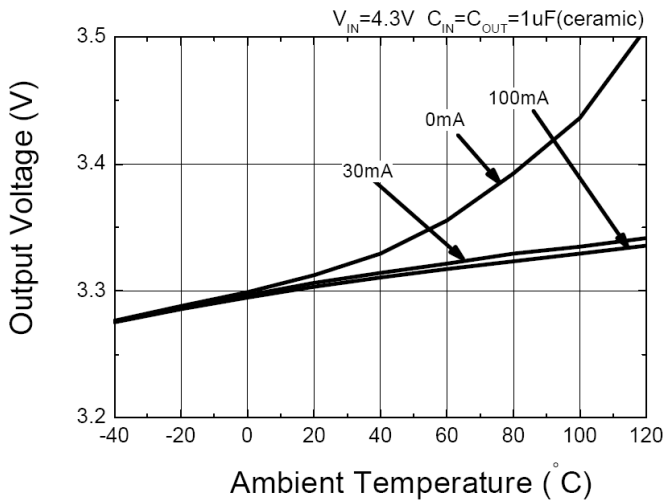
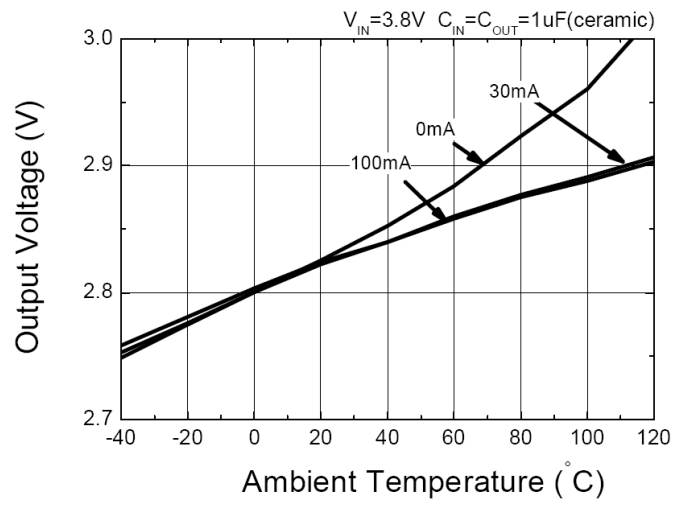
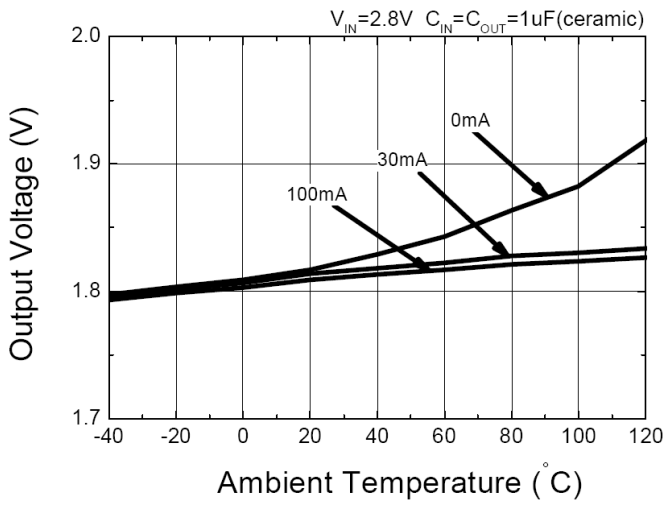

(6) Supply Current vs. Output Current

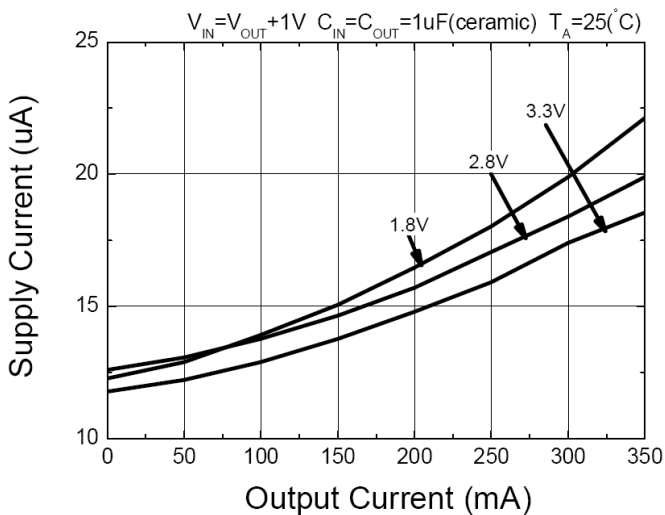

(7) Output Voltage vs. Input Voltage

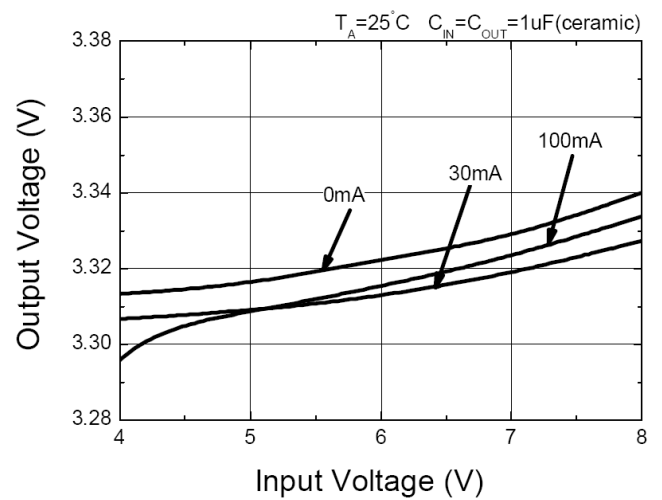
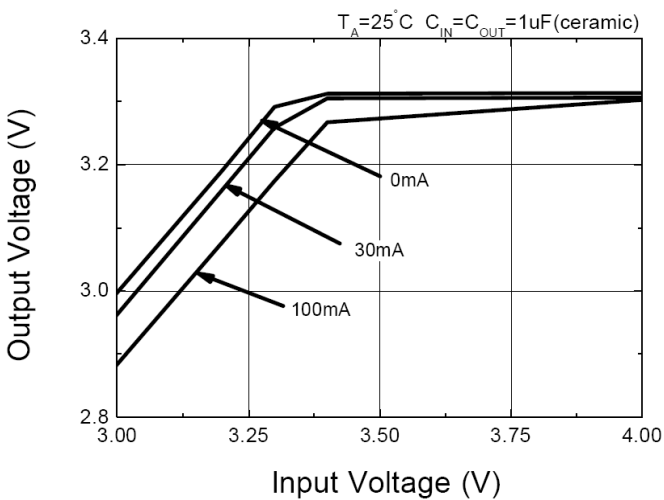
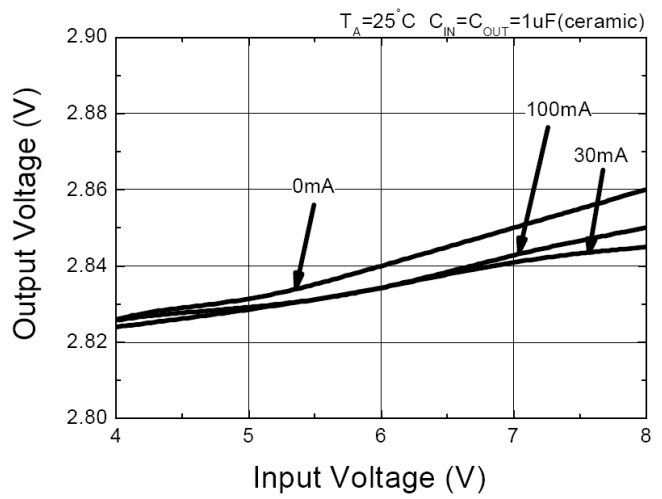
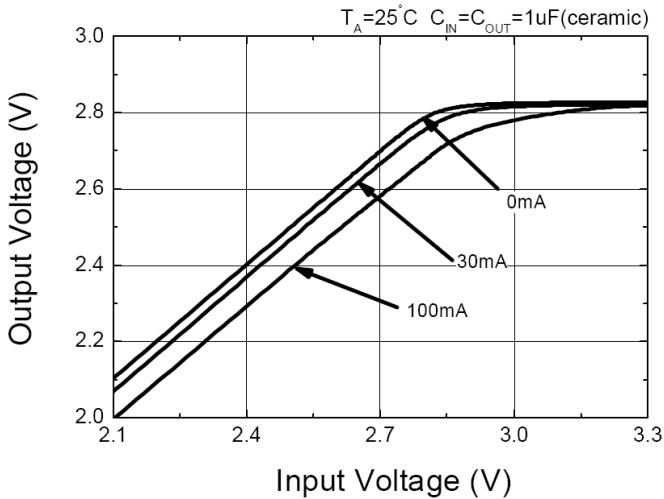
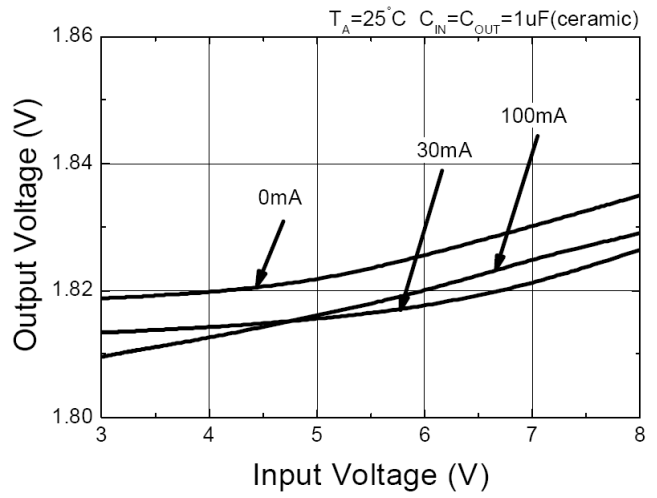
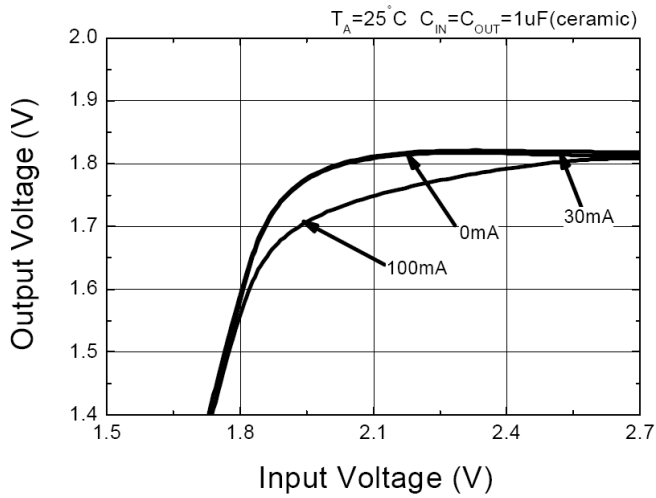

SOT-25 Dimension

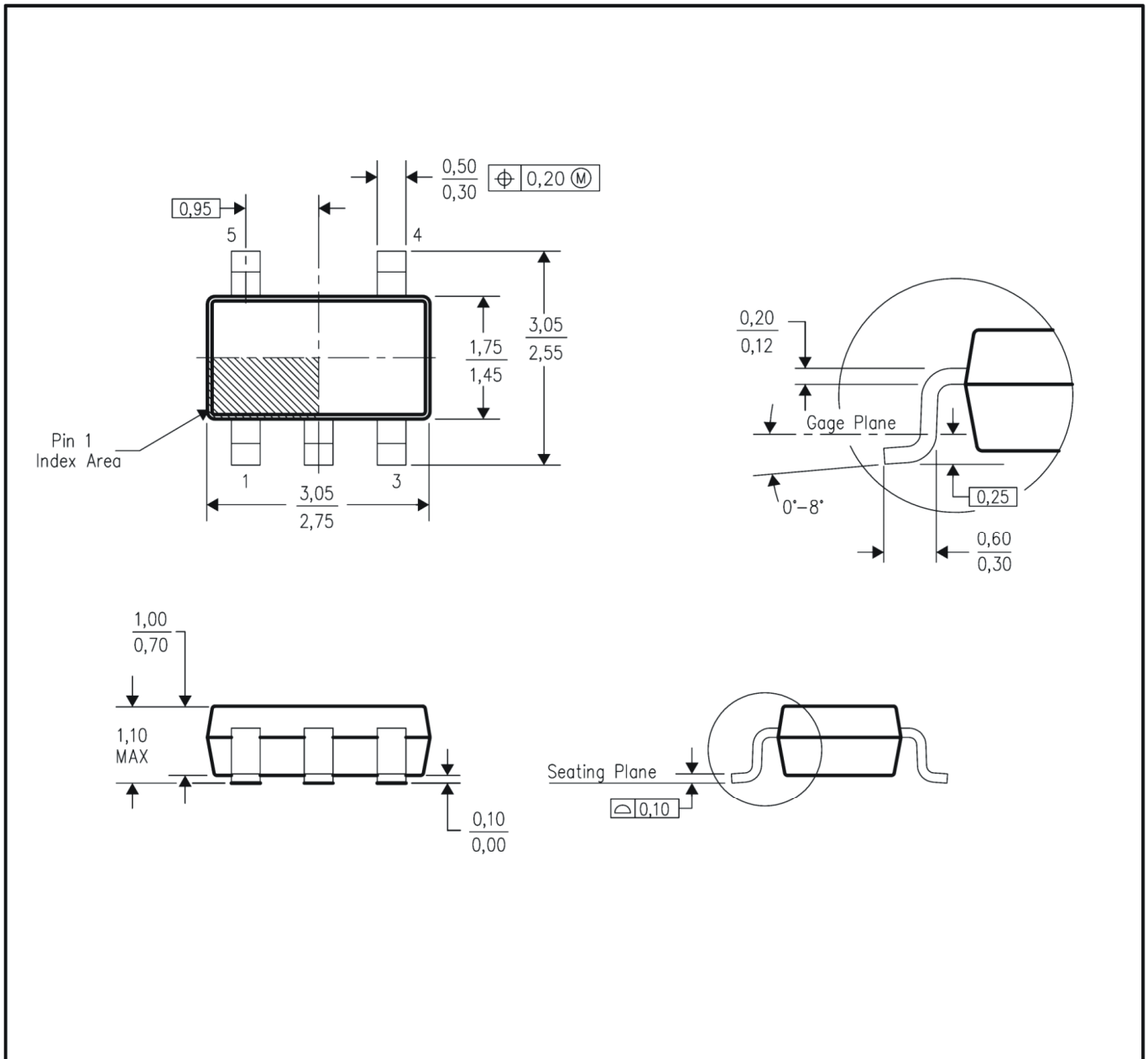

NOTES:

- All linear dimensions are in millimeters.
- This drawing is subject to change without notice.
- Body dimensions do not include mold flash or protrusion.
- Falls within JEDEC MO-193 variation AB (5 pin).

VSON-6 (2x2) Dimension

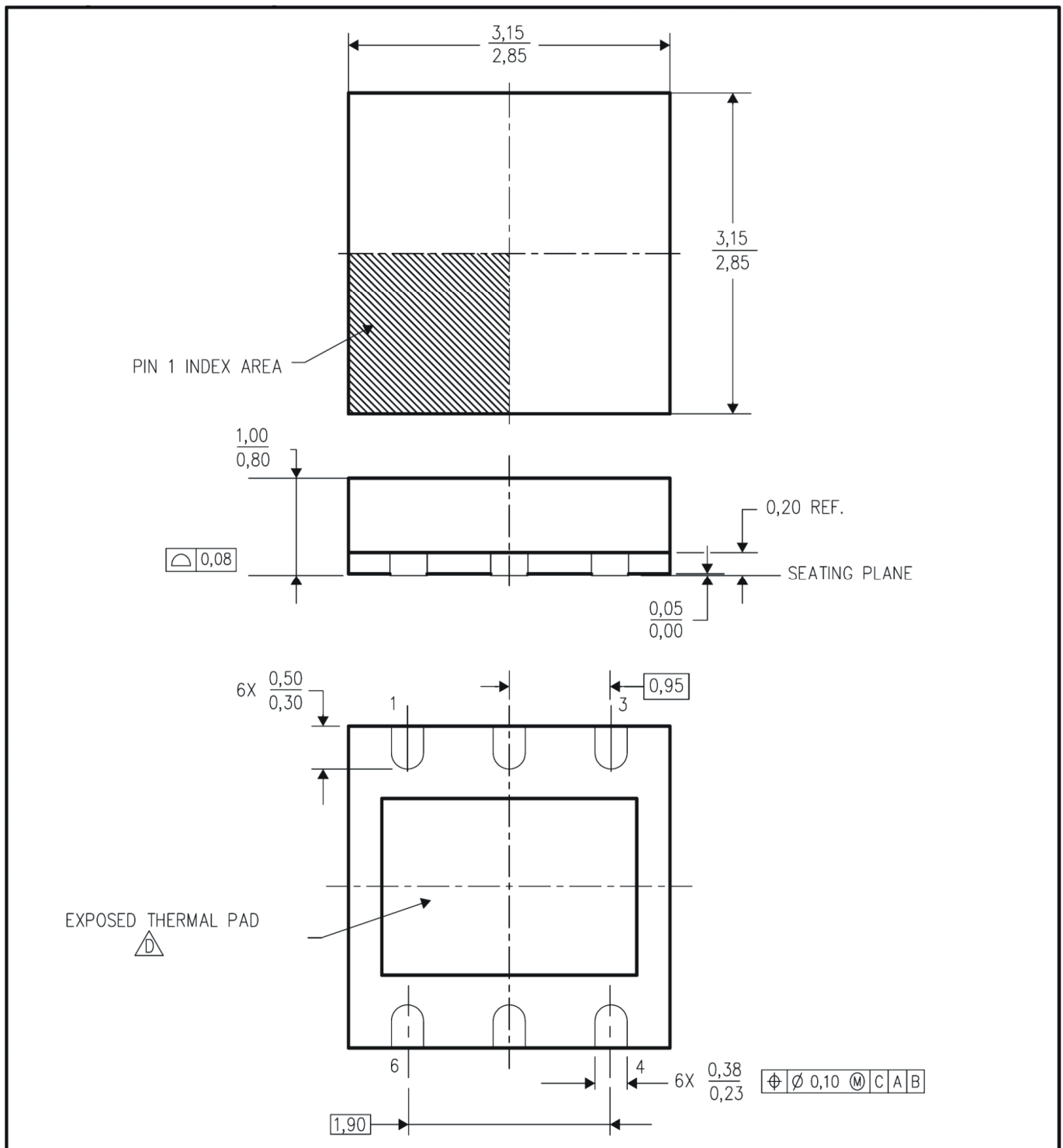

NOTES:

- All linear dimensions are in millimeters.
- This drawing is subject to change without notice.
- Small Outline No-Lead (SON) package configuration.
- The package thermal pad must be soldered to the board for thermal and mechanical performance.

Soldering Methods for Orister's Products

1. Storage environment: Temperature=10°C~35°C Humidity=65%±15%
2. Reflow soldering of surface-mount devices

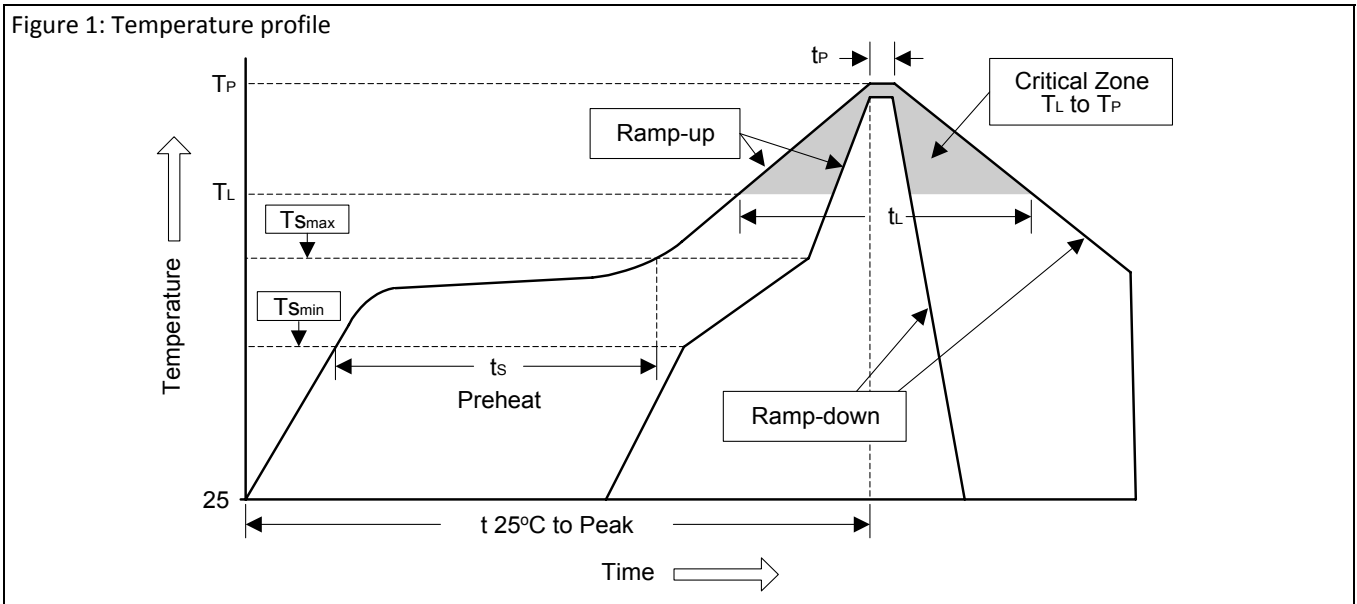

Profile Feature	Sn-Pb Eutectic Assembly	Pb-Free Assembly
Average ramp-up rate (T_L to T_P)	<3°C/sec	<3°C/sec
Preheat		
- Temperature Min (T_{Smin})	100°C	150°C
- Temperature Max (T_{Smax})	150°C	200°C
- Time (min to max) (t_s)	60~120 sec	60~180 sec
T_{Smax} to T_L		
- Ramp-up Rate	<3°C/sec	<3°C/sec
Time maintained above:		
- Temperature (T_L)	183°C	217°C
- Time (t_L)	60~150 sec	60~150 sec
Peak Temperature (T_P)	240°C +0/-5°C	260°C +0/-5°C
Time within 5°C of actual Peak Temperature (t_P)	10~30 sec	20~40 sec
Ramp-down Rate	<6°C/sec	<6°C/sec
Time 25°C to Peak Temperature	<6 minutes	<8 minutes

3. Flow (wave) soldering (solder dipping)

Products	Peak temperature	Dipping time
Pb devices.	245°C ±5°C	5sec ±1sec
Pb-Free devices.	260°C +0/-5°C	5sec ±1sec

Important Notice:

© Orister Corporation

Orister cannot assume responsibility for use of any circuitry other than circuitry entirely embodied in an Orister product. No circuit patent licenses, copyrights, mask work rights, or other intellectual property rights are implied.

Orister reserves the right to make changes to their products or specifications or to discontinue any product or service without notice. Except as provided in Orister's terms and conditions of sale, Orister assumes no liability whatsoever, and Orister disclaims any express or implied warranty relating to the sale and/or use of Orister products including liability or warranties relating to fitness for a particular purpose, merchantability, or infringement of any patent, copyright or other intellectual property right. In order to minimize risks associated with the customer's applications, adequate design and operating safeguards must be provided by the customer to minimize inherent or procedural hazards. Testing and other quality control techniques are utilized to the extent Orister deems necessary to support this warranty. Specific testing of all parameters of each device is not necessarily performed.

Orister and the Orister logo are trademarks of Orister Corporation. All other brand and product names appearing in this document are registered trademarks or trademarks of their respective holders.