

Part/Keyword Search



Detailed Drawing



Printer Friendly Datasheet

PN9117 / SPN9117*

* Part number for additional environmental screening.

Performance Data

Frequency	10.0 - 1000.0 MHz
Gain	12.0 dB Typical 10.0 dB Min
Noise Figure	4.0 dB Typical 6.0 dB Max
P _{1dB}	15.5 dBm Typical 14.5 dBm Min
3 rd Order Intercept	28.0 dBm Typical
2 nd Order Intercept	40.0 dBm Typical
VSWR	1.5/2.0 Input Typ/Max 1.5/2.0 Output Typ/Max
Reverse Isolation	-14.5 dB Typical -13.5 dB Min
Power Supply	15.0 Volts 46.0 mA
Operating Temperature	-55.0 - 85.0 °C

Package Drawing

SM-11 (Surface Mount)

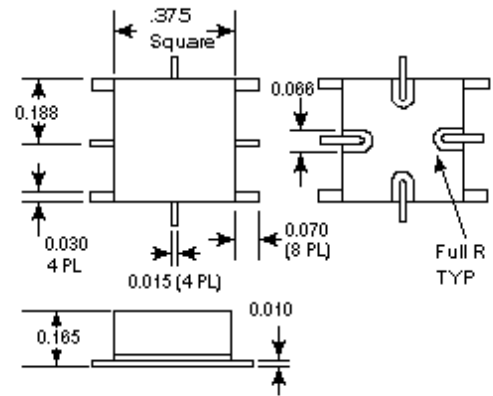

Gain

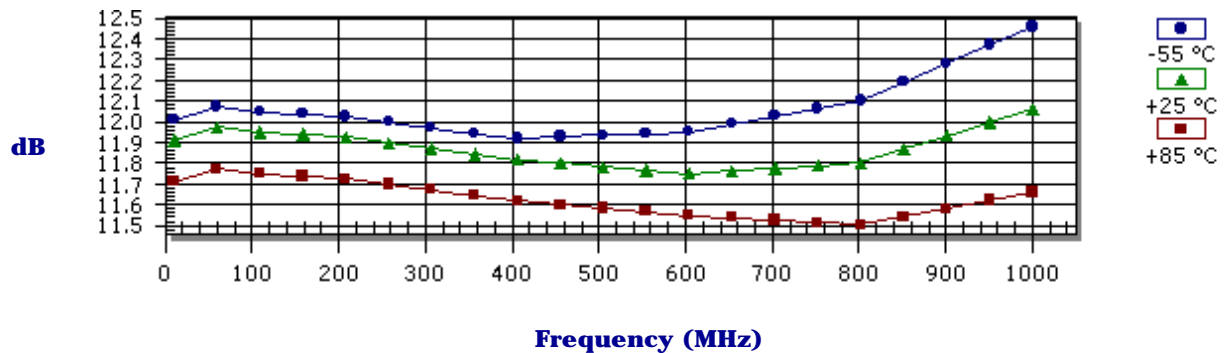

Noise Figure

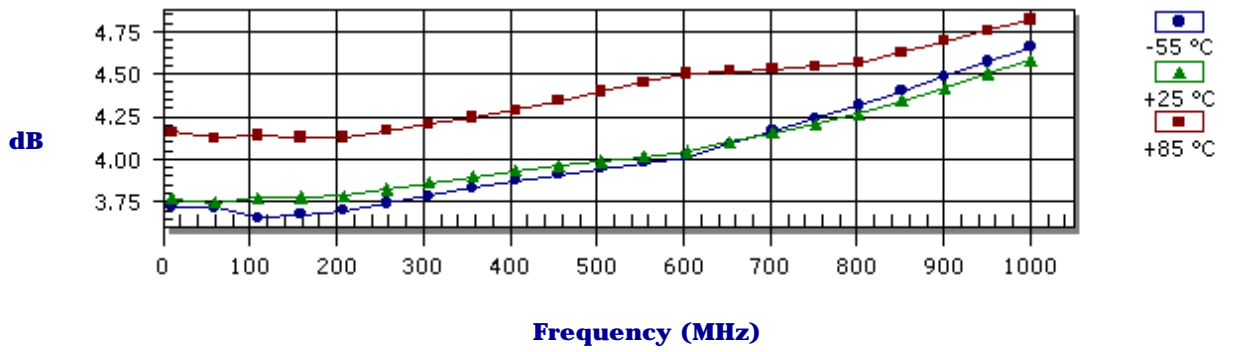

P_{1dB} Compression Point

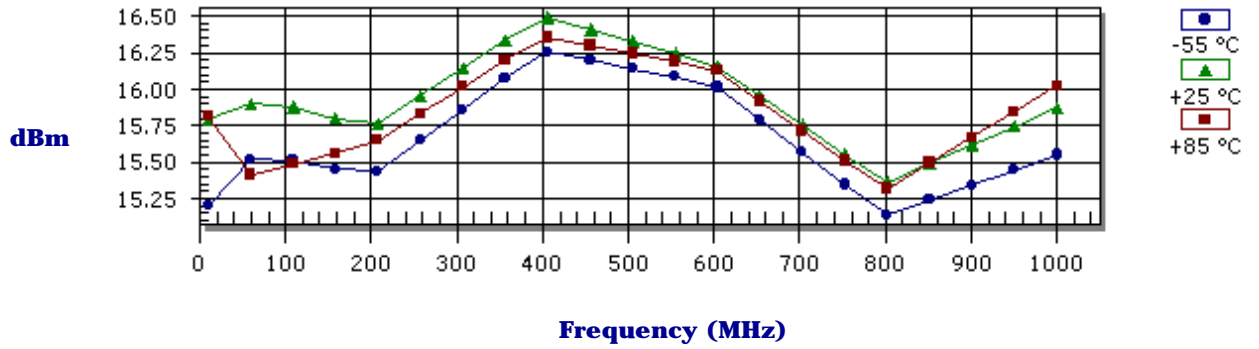

Reverse Isolation

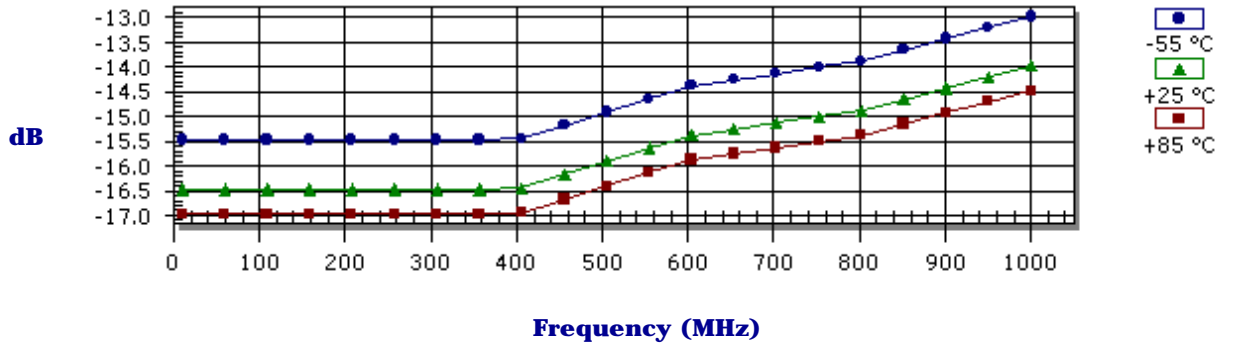

Input VSWR

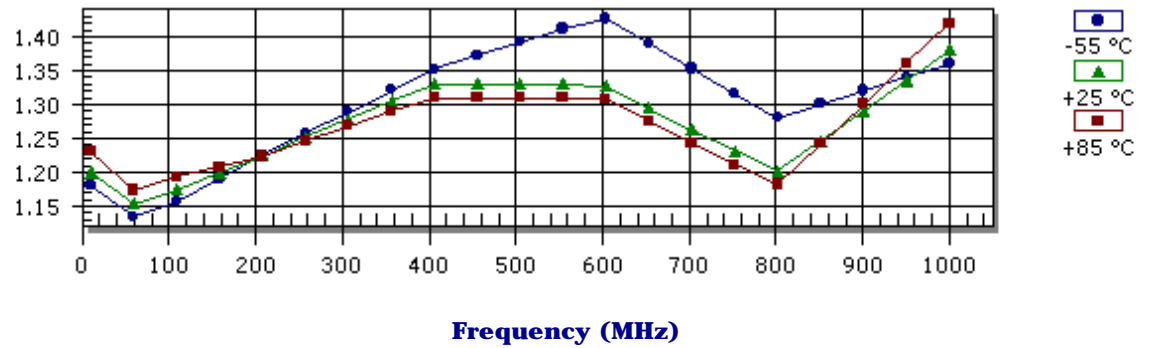

Output VSWR

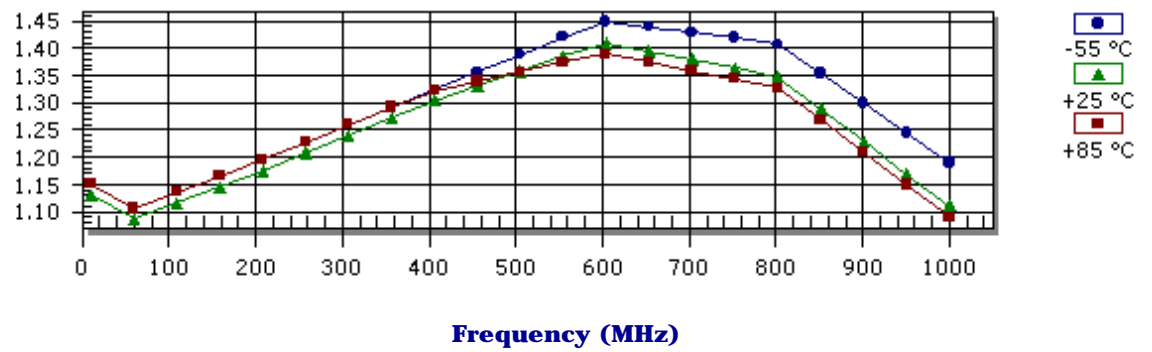

S-Parameters

Frequency	S11 Mag	S11 Ang	S21 Mag	S21 Ang	S12 Mag	S12 Ang	S22 Mag	S22 Ang
10.0	0.090	-23.00	3.940	-177.00	0.150	4.00	0.060	59.00
50.0	0.070	3.00	3.970	173.00	0.150	-1.00	0.040	-13.00
100.0	0.080	12.00	3.960	165.00	0.150	-3.00	0.050	-45.00
200.0	0.100	22.00	3.950	149.00	0.150	-7.00	0.080	-78.00
400.0	0.140	17.00	3.900	118.00	0.150	-14.00	0.130	-121.00
600.0	0.140	-2.00	3.870	88.00	0.170	-23.00	0.170	-153.00
800.0	0.090	-45.00	3.890	56.00	0.180	-34.00	0.150	170.00
1000.0	0.160	169.00	4.010	18.00	0.200	-53.00	0.050	97.00

Absolute Maximum Conditions

Maximum Operating Temperature	-55.0 - 100.0 °C	Maximum Storage Temperature	-62.0 - 125.0 °C
Maximum Case Temperature	125.0 °C	Maximum Supply Voltage	18.0 Volts
Continuous RF Input Power	13.0 dBm	Short Term RF Input Power (1 minute max)	50.0 mW
Maximum Peak Power (3 µsec max)	0.5 W		

i2 Technologies US, Inc.

HTML Pages converted to PDF Document

This document contain component information from the manufacturer's website which are not available in a revision controlled document from the manufacturer. To facilitate the addition of these parts into the Electronics Database, we are converting the HTML pages related to that part, from the manufacturer's website into Adobe PDF format. The contents of this document is based on the information provided on the manufacturer's website, therefore the information may have been changed by the manufacturer since this was created.

