

## P-Channel 40-V (D-S) MOSFET

These miniature surface mount MOSFETs utilize a high cell density trench process to provide low  $r_{DS(on)}$  and to ensure minimal power loss and heat dissipation. Typical applications are DC-DC converters and power management in portable and battery-powered products such as computers, printers, PCMCIA cards, cellular and cordless telephones.

- Low  $r_{DS(on)}$  provides higher efficiency and extends battery life
- Low thermal impedance copper leadframe DPAK saves board space
- Fast switching speed
- High performance trench technology

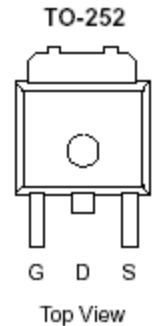
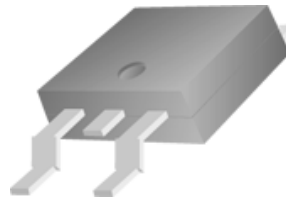

PRODUCT SUMMARY		
$V_{DS}$ (V)	$r_{DS(on)}$ m( $\Omega$ )	$I_D$ (A)
-40	69 @ $V_{GS} = -10V$	22
	106 @ $V_{GS} = -4.5V$	18

ABSOLUTE MAXIMUM RATINGS ( $T_A = 25^\circ C$ UNLESS OTHERWISE NOTED)			
Parameter	Symbol	Maximum	Units
Drain-Source Voltage	$V_{DS}$	-40	V
Gate-Source Voltage	$V_{GS}$	$\pm 20$	
Continuous Drain Current <sup>a</sup>	$T_A = 25^\circ C$ $I_D$	22	A
Pulsed Drain Current <sup>b</sup>	$I_{DM}$	$\pm 72$	
Continuous Source Current (Diode Conduction) <sup>a</sup>	$I_S$	-30	A
Power Dissipation <sup>a</sup>	$T_A = 25^\circ C$ $P_D$	50	W
Operating Junction and Storage Temperature Range	$T_j, T_{stg}$	-55 to 175	$^\circ C$

THERMAL RESISTANCE RATINGS			
Parameter	Symbol	Maximum	Units
Maximum Junction-to-Ambient <sup>a</sup>	$R_{\theta JA}$	50	$^\circ C/W$
Maximum Junction-to-Case	$R_{\theta JC}$	3.0	$^\circ C/W$

Notes

- Surface Mounted on 1" x 1" FR4 Board.
- Pulse width limited by maximum junction temperature

SPECIFICATIONS (T <sub>A</sub> = 25°C UNLESS OTHERWISE NOTED)						
Parameter	Symbol	Test Conditions	Limits			Unit
			Min	Typ	Max	
<b>Static</b>						
Gate-Threshold Voltage	V <sub>GS(th)</sub>	V <sub>DS</sub> = V <sub>GS</sub> , I <sub>D</sub> = -250 uA	-1			
Gate-Body Leakage	I <sub>GSS</sub>	V <sub>DS</sub> = 0 V, V <sub>GS</sub> = ±25 V			±100	nA
Zero Gate Voltage Drain Current	I <sub>DSS</sub>	V <sub>DS</sub> = -24 V, V <sub>GS</sub> = 0 V			-1	uA
		V <sub>DS</sub> = -24 V, V <sub>GS</sub> = 0 V, T <sub>J</sub> = 55°C			-5	
On-State Drain Current <sup>A</sup>	I <sub>D(on)</sub>	V <sub>DS</sub> = -5 V, V <sub>GS</sub> = -10 V	-41			A
Drain-Source On-Resistance <sup>A</sup>	r <sub>DS(on)</sub>	V <sub>GS</sub> = -10 V, I <sub>D</sub> = -22 A			69	mΩ
		V <sub>GS</sub> = -4.5 V, I <sub>D</sub> = -18 A			106	
Forward Transconductance <sup>A</sup>	g <sub>fs</sub>	V <sub>DS</sub> = -15 V, I <sub>D</sub> = -22 A		31		S
Diode Forward Voltage	V <sub>SD</sub>	I <sub>S</sub> = -41 A, V <sub>GS</sub> = 0 V		-0.7		V
<b>Dynamic<sup>b</sup></b>						
Total Gate Charge	Q <sub>g</sub>	V <sub>DS</sub> = -15 V, V <sub>GS</sub> = -4.5 V, I <sub>D</sub> = -22 A		10		nC
Gate-Source Charge	Q <sub>gs</sub>			2.2		
Gate-Drain Charge	Q <sub>gd</sub>			2.5		
<b>Switching</b>						
Turn-On Delay Time	t <sub>d(on)</sub>	V <sub>DD</sub> = -15 V, R <sub>L</sub> = 15 Ω , I <sub>D</sub> = -24 A, V <sub>GEN</sub> = -10 V, R <sub>G</sub> = 6Ω		10		nS
Rise Time	t <sub>r</sub>			2.8		
Turn-Off Delay Time	t <sub>d(off)</sub>			53.6		
Fall-Time	t <sub>f</sub>			46		

Notes

- a. Pulse test: PW ≤ 300us duty cycle ≤ 2%.
- b. Guaranteed by design, not subject to production testing.

**FREESCALE** reserves the right to make changes without further notice to any products herein. Freescale makes no warranty, representation or guarantee regarding the suitability of its products for any particular purpose, nor does Freescale assume any liability arising out of the application or use of any product or circuit, and specifically disclaims any and all liability, including without limitation special, consequential or incidental damages. "Typical" parameters which may be provided in Freescale data sheets and/or specifications can and do vary in different applications and actual performance may vary over time. All operating parameters, including "Typicals" must be validated for each customer application by customer's technical experts. Freescale does not convey any license under its patent rights nor the rights of others. Freescale products are not designed, intended, or authorized for use as components in systems intended for surgical implant into the body, or other applications intended to support or sustain life, or for any other application in which the failure of the Freescale product could create a situation where personal injury or death may occur. Should Buyer purchase or use Freescale products for any such unintended or unauthorized application, Buyer shall indemnify and hold Freescale and its officers, employees, subsidiaries, affiliates, and distributors harmless against all claims, costs, damages, and expenses, and reasonable attorney fees arising out of, directly or indirectly, any claim of personal injury or death associated with such unintended or unauthorized use, even if such claim alleges that Freescale was negligent regarding the design or manufacture of the part. Freescale is an Equal Opportunity/Affirmative Action Employer.

# Typical Electrical Characteristics

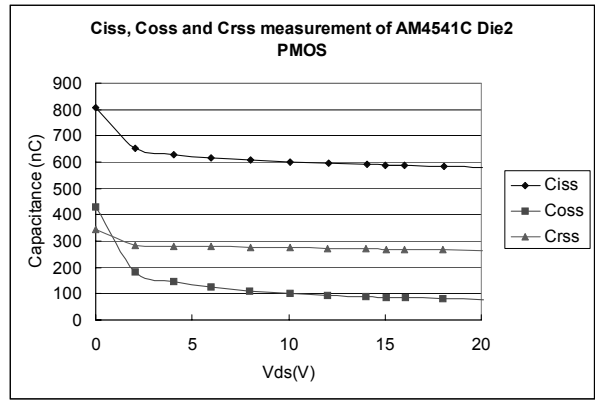
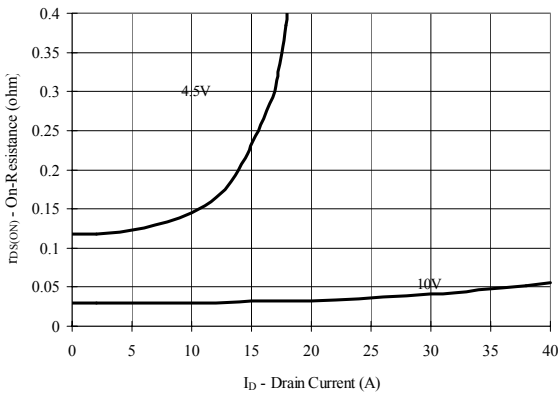
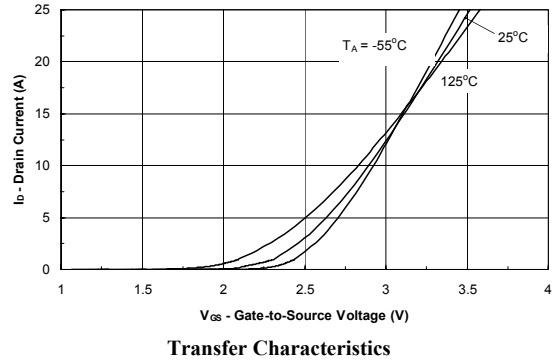
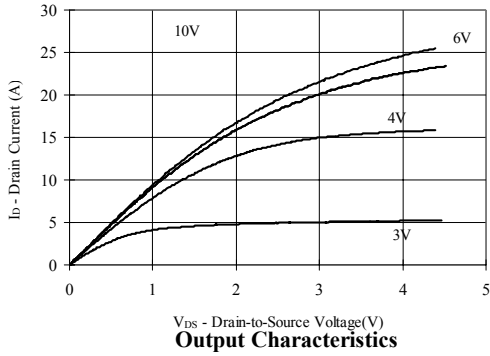
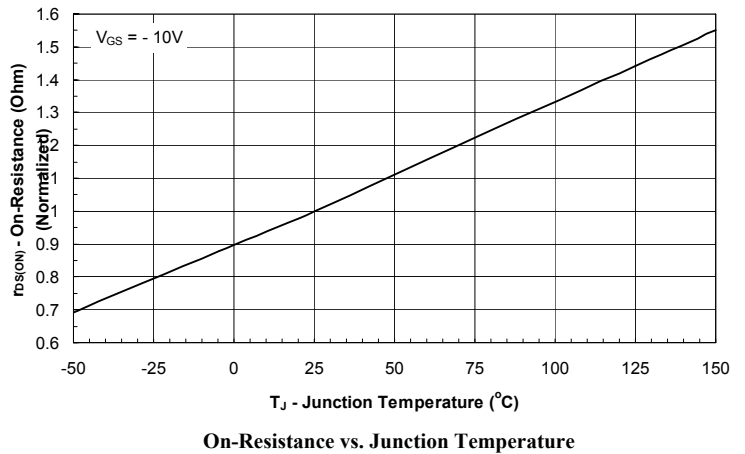
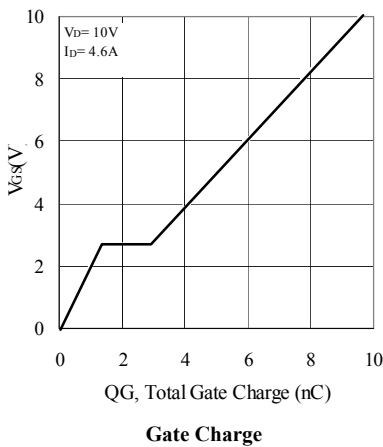
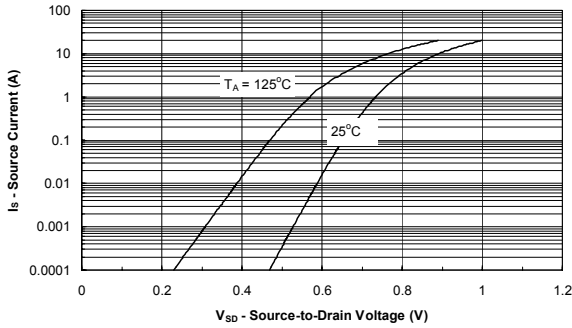

Figure 3. On Resistance Vs Vgs Voltage



## Typical Electrical Characteristics



Source-Drain Diode Forward Voltage

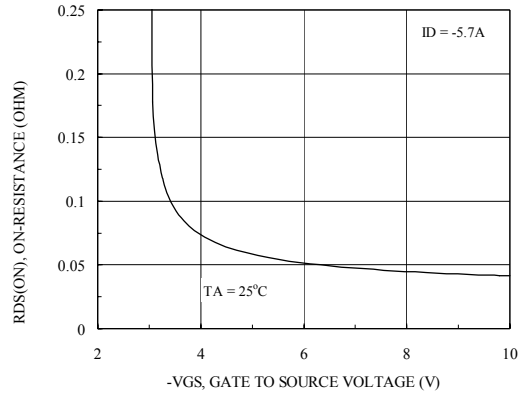
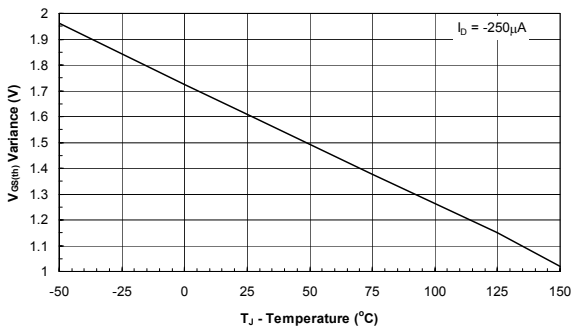

Figure 8. On-Resistance with Gate to Source Voltage



Threshold Voltage

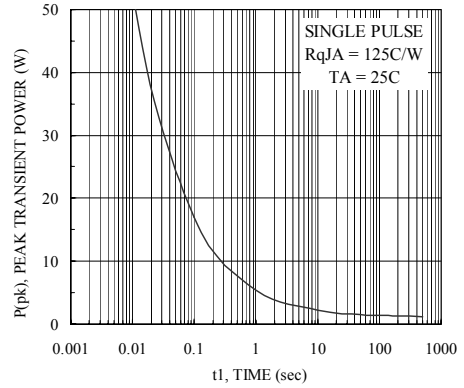

Figure 10. Single Pulse Maximum Power Dissipation

### Normalized Thermal Transient Junction to Ambient

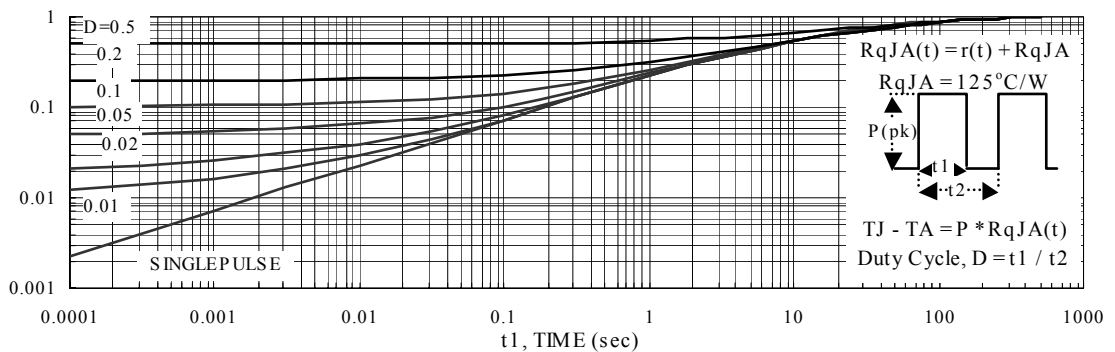
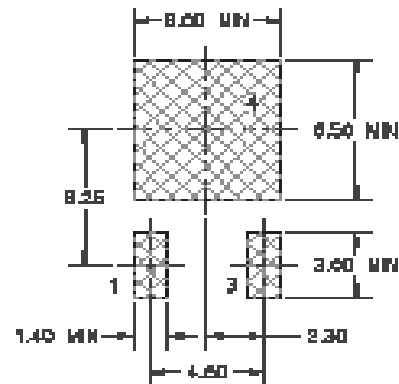
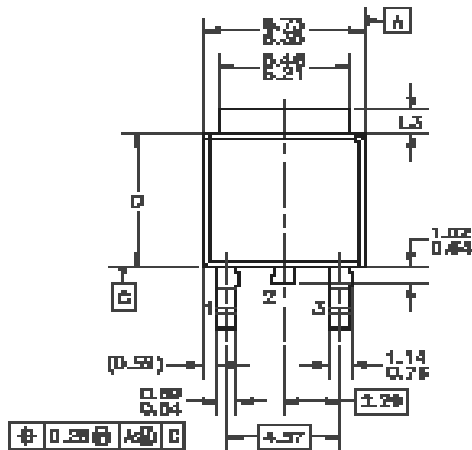
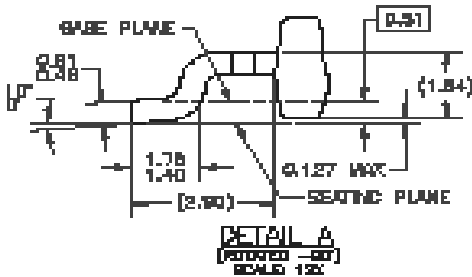
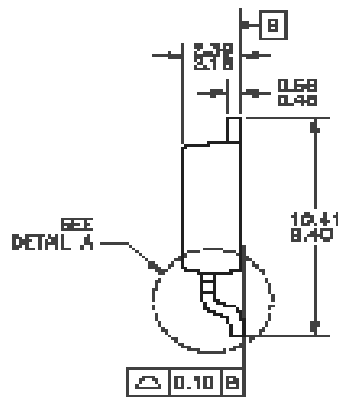
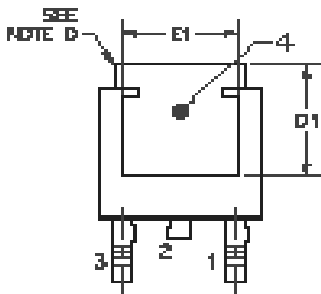

Figure 11. Transient Thermal Response Curve

# Package Information



LAND PATTERN RECOMMENDATION



- NOTES: UNLESS OTHERWISE SPECIFIED
- A) ALL DIMENSIONS ARE IN MILLIMETERS.
  - B) THIS PACKAGE CONFORMS TO JEDEC, TO-262, ISSUE C, VARIATION AA IN REF, DATED NOV. 1999.
  - C) DIMENSIONING AND TOLERANCING PER ASME Y14.00M-1994.
  - D) HEAT SINK TOP EDGE COULD BE IN CHAMFERED CORNERS OR EDGE PROTRUSION.
  - E) DIMENSIONS L3,D,E1&D1 TABLE:

	SECTION AA	SECTION AB
L3	0.68-1.27	1.68-2.50
D	0.97-0.99	0.93-0.99
E1	4.32 MIN	3.81 MIN
D1	3.81 MIN	4.37 MIN