

HEQB-25A-48V-3.3V

48V_{in} 25A_{out} 3.3V_{out}, DC-DC Converter High Efficiency, Isolated Quarter Brick



Features

- Very high efficiency: 91%
- Wide input voltage range (36 to 75Vdc)
- Low profile, industry standard footprint and pin out: 2.3" x 1.45" x 0.36" (58.4mm x 36.8mm x 9.35mm)
- Total weight: 34g. (1.2oz.)
- Remote ON/OFF
- Output voltage trim – Industry standard trim equation
- Remote sense
- Fixed Frequency (Input-Output ripple 400 kHz)
- Under voltage lockout (UVLO), Input – auto recover
- Over voltage protection – auto recover
- Over current protection – auto recover
- Over temperature protection – auto recover
- Operating temperature range: -40°C to +100°C
- Input to Output Isolation at 2000Vdc, 10MΩ
- UL/CUL, CSA/CSA_{US}, TUV and KEMA Certified
- ISO 9001 Certified manufacturing processes



Product Highlights

- HEQB Family of dc-dc converters is Magnetek's solution for next generation, cutting-edge board applications.
- Synchronous rectification uses MOSFET instead of Schottky diodes providing extreme reduction in heat generation, boosting efficiency, eliminating the need for a heat sink and increased reliability.
- Low profile (0.36"), open frame construction allows smaller card pitch and improves system ventilation.
- Fixed switching frequency provides predictable EMI characteristics.

HEQB-25A-48V-3.3V

Mechanical Drawings

- All dimensions are in inches (mm)
 Tolerances: x.xx in. +/-0.2 in. (0.5mm)

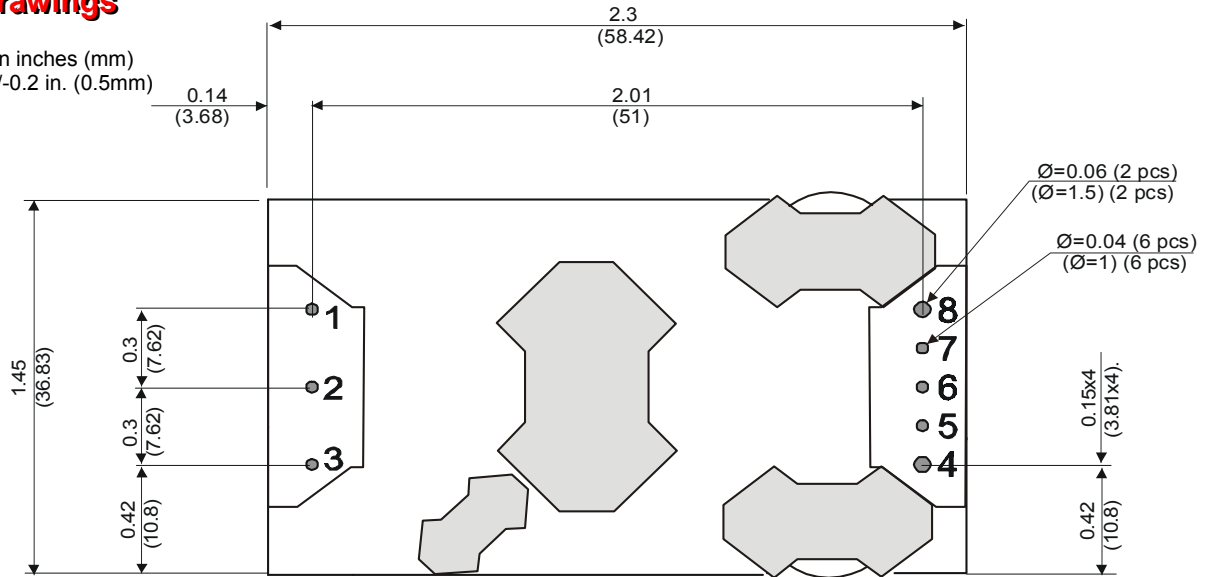

Bottom View

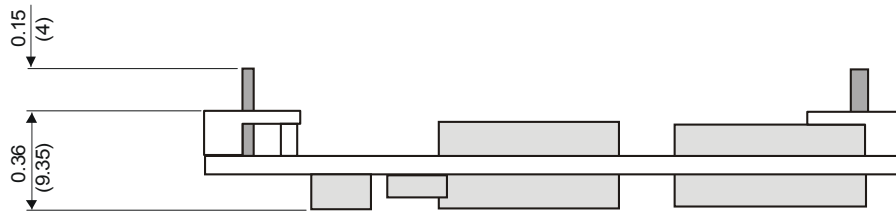

PINOUT Description		
Pin	Name	Function
1	Vin (-)	Negative terminal for the input bus
2	ON/OFF	External input signal, TTL. Output voltage ON or OFF
3	Vin (+)	Positive terminal for the input bus
4	Vout (+)	Positive terminal for output voltage
5	Sense (+)	Positive remote sense
6	TRIM	Output voltage TRIM
7	Sense (-)	Negative remote sense
8	Vout (-)	Return terminal for output voltage

HEQB-25A-48V-3.3V

Specifications

(Typical value standard at nominal input line, full load, airflow 300 LFM, 25°C ambient temperature unless otherwise specified)

Input Characteristics	Notes & Conditions	Min	Typ	Max	Units
Operating Input Voltage Range	Note 1	36	48	75	V
Input Surge Voltage	T < 10 μ s			100	V
Input Under-Voltage Lockout					
<i>Turn-On Voltage Threshold</i>		34.3	34.8	35.4	V
<i>Turn-Off Voltage Threshold</i>		33.8	34.3	34.8	V
<i>Lockout Hysteresis Voltage</i>		0.4	0.5	0.6	V
Maximum Input Current	V _{IN} =36V; Full Load			2.59	A
No-load Input Current			75	100	mA
Off Converter Input Current			4	6	mA
Inrush Current Transient Rating			0.01		A ² s
Input Reflected-Ripple Current	RMS; see figures 1, 2		3		mA

NOTE 1: Absolute max. input voltage 80V

Output Characteristics	Notes & Conditions	Min	Typ	Max	Units
Output Voltage Set Point	50 % Load	3.28	3.30	3.32	V
Output Voltage Regulation					
<i>Load</i>	V _{nom} = 48V		± 5	± 8	mV
<i>Line</i>	I _o = 15A		± 2	± 5	mV
<i>Temperature</i>			± 15	± 30	mV
Total Output Voltage Range		3.265		3.335	V
Output Voltage Ripple and Noise	20 MHz bandwidth				
<i>Peak to Peak</i>	Full load, see figures 1, 4		60	100	mV
<i>RMS</i>			14	20	mV
Operating Output Current Range	I _o , see figures 12, 13	0	-	25	A
Output DC Current Limit Inception		26	27	29	A
Output DC Current Limit Shutdown Voltage	See figure 5	2.75	2.88	3.05	V
Admissible Output capacitance	Full load, resistive	0		20000	μ F

Dynamic Characteristics	Notes & Conditions	Min	Typ	Max	Units
Output Voltage Current Transient	470 μ F load cap, 1A/ μ s; figures 8, 9				
<i>Positive Step Change</i>	50% I _o to 75% I _o		170		mV
<i>Negative Step Change</i>	75% I _o to 50% I _o		170		mV
<i>Settling Time to 1%</i>			300		μ s
Turn-On Transient	Figures 6 and 7				
<i>Overshoot</i>			0		%
<i>Turn-On Time</i>	Full load		15	20	ms
<i>Start-Up Inhibit Period</i>			120		ms

Efficiency	Notes & Conditions	Min	Typ	Max	Units
100% Load	V _{IN} = 48V		90.5		%
80% Load	V _{IN} = 48V		91.0		%
56% Load	V _{IN} = 48V		90.5		%

Isolation Characteristics	Notes & Conditions	Min	Typ	Max	Units
Isolation Voltage - input to output	Basic Isolation		2000		V _{DC}
Isolation Capacitance	Basic Isolation		2200		pF
Isolation Resistance		10			M Ω

HEQB-25A-48V-3.3V

Feature Characteristics		Min.	Typ.	Max	Units
Switching frequency	Double Frequency for Input-Output Ripple	190	200	210	kHz
ON/OFF Control					
Off-State Voltage		2.7		10	V
On-State Voltage		0		0.5	V
Output Voltage Trim Range		-10		+10	%
Output Voltage Remote Sense Range				+10	%
Over Voltage Protection Threshold		115	125	130	%
Over Current Protection Threshold		26-35 A			
Over Temperature Protection Threshold	Average PCB temperature	120	125		°C

General Characteristics	Notes & Conditions	Min	Typ	Max	Units
Operating Range Temperature	Maximum Rating	-40		+100	°C
Storage Temperature	Maximum Rating	-50		+120	°C
Relative Humidity	Non condensing	5		95	%
Calculated MTBF	Bellcore Issue 4 RDF93 HRD Issue 5	Min. 1,500,000 hours			

Safety and Regulatory	
TUV and KEMA certified for basic insulation compliance to EN06950 requirements	
UL and CSA 22.2 No. 950-95(US and Canada) certified with basic insulation for compliance to UL60950.	
Note : An external input fuse must always be used for compliance to listed safety requirements.	
CE compliant per 72/23/EEC (Low voltage directive) and 93/68/EEC to facilitate CE Mark at system level.	
Material flammability rating, UL94V-0	
NEBS compliant	

Characteristic Curves

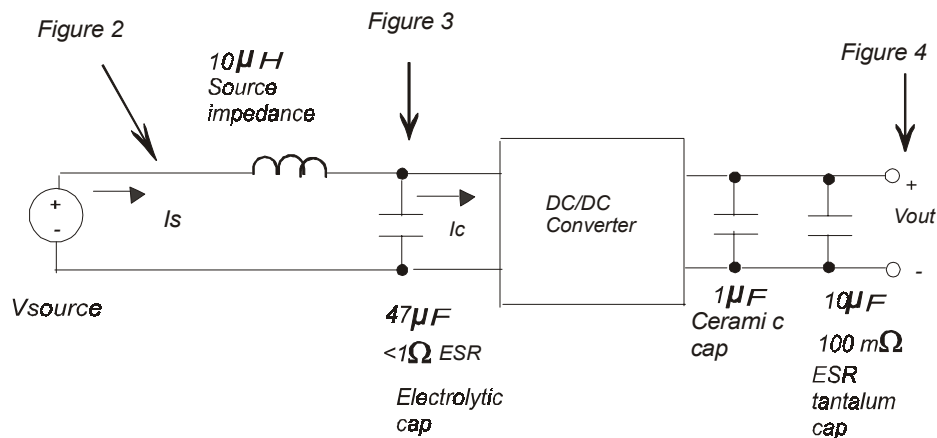

FIGURE 1: Set-up diagram showing measurement points for: Input Terminal Ripple Current, Input Reflected Ripple Current and Output Voltage Ripple

HEQB-25A-48V-3.3V

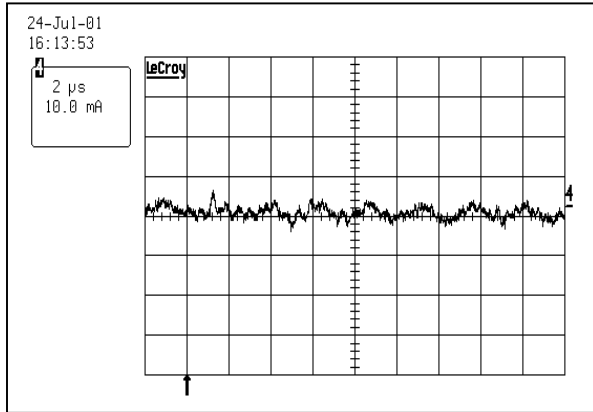

FIGURE 2: Input Reflected Ripple Current, set-up per figure 1; 10 μ H source impedance. Nominal input voltage at full rated load.

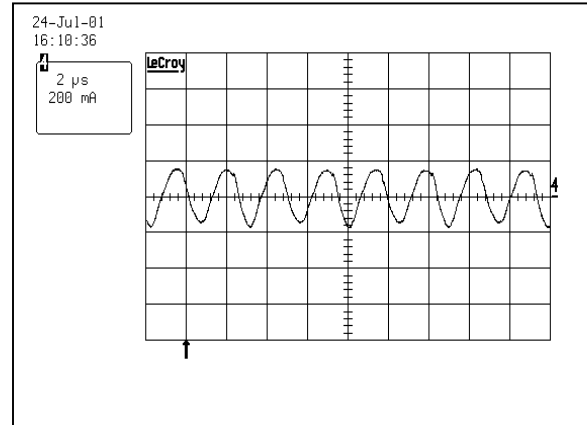

FIGURE 3: Input Terminal Ripple Current, set-up per figure 1, 10 μ H source impedance and 47 μ F electrolytic capacitor Nominal input voltage at full rated load.

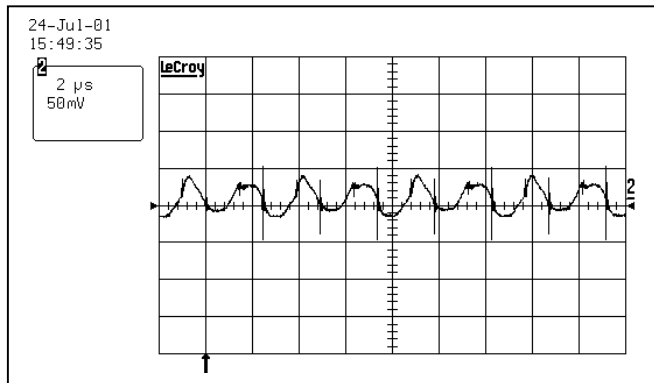

FIGURE 4: Output Voltage Ripple, set-up per figure 1, 1 μ F ceramic capacitor and 10 μ F tantalum capacitor. Nominal input voltage at full rated load

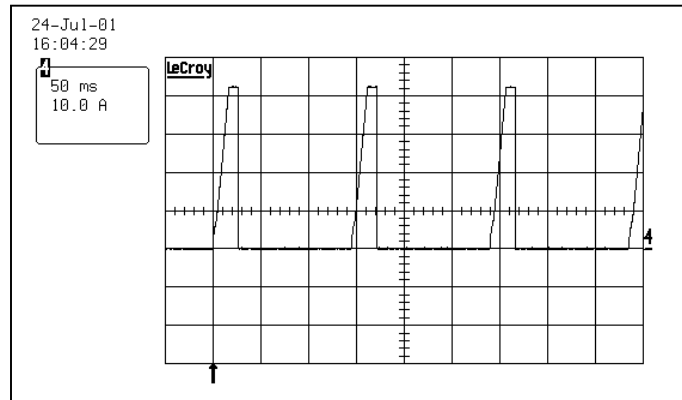

FIGURE 5: Load current as a function of time while attempting to enable into a short circuit, <10m Ω .

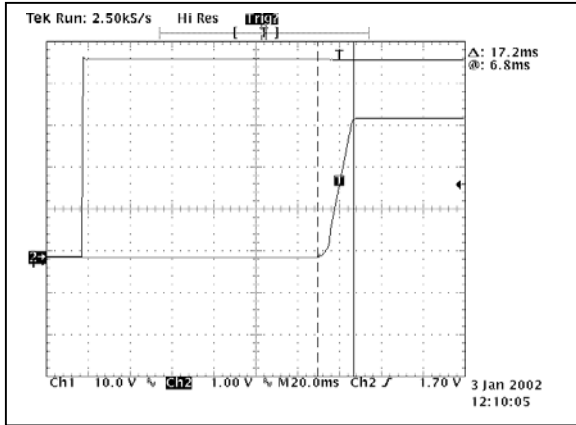

FIGURE 6: Turn-on transient at full rated load.
Upper trace: input voltage.
Lower trace: output voltage

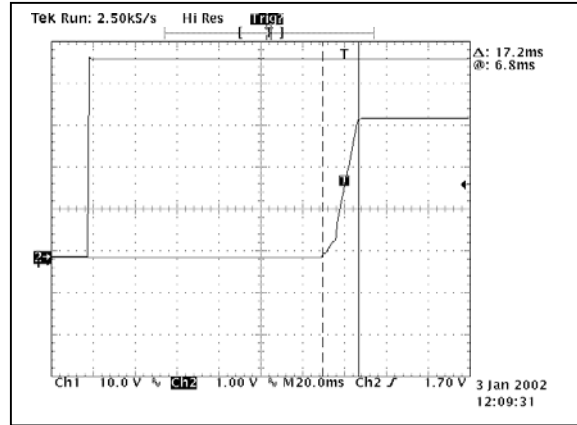

FIGURE 7: Turn-on transient at zero load.
Upper trace: input voltage
Lower trace: output voltage

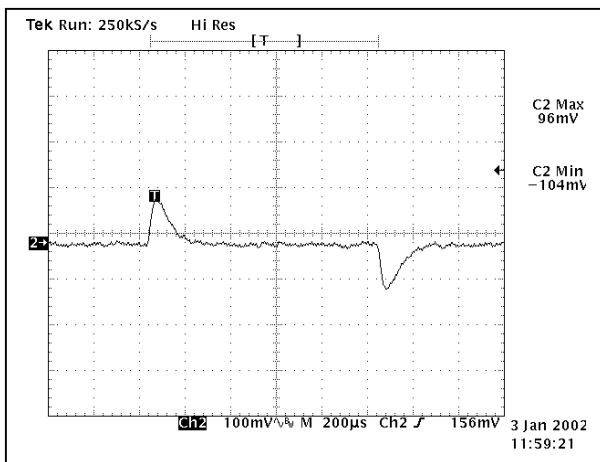

FIGURE 8: Output voltage response to dynamic change in load current: 75% I_o to 50% I_o , where:
 $di / dt = 0.1A / \mu s$
Load cap: 10 μF , 100 m Ω ESR tantalum capacitor and 1 μF ceramic capacitor

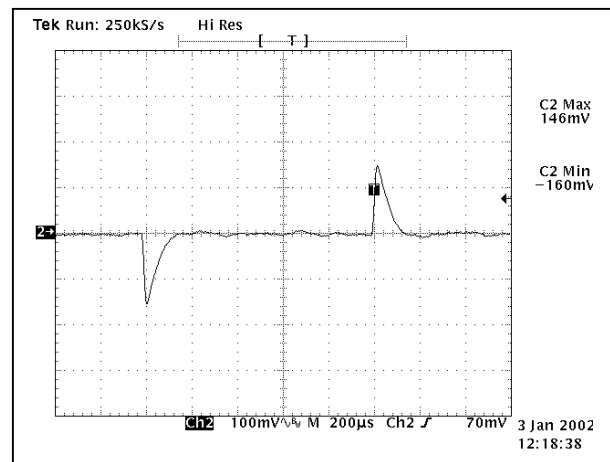

FIGURE 9: Output voltage response to step-change in load current. 50% I_o to 75% I_o , where:
 $di / dt = 1A / \mu s$
Load cap: 470 μF , 30 m Ω ESR tantalum capacitor and 1 μF ceramic capacitor

HEQB-25A-48V-3.3V

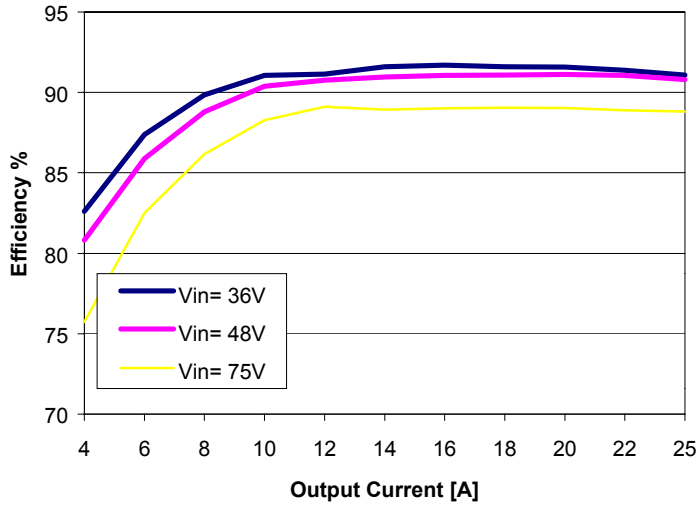

FIGURE 10: Efficiency vs. load current for listed input voltages at 25°C

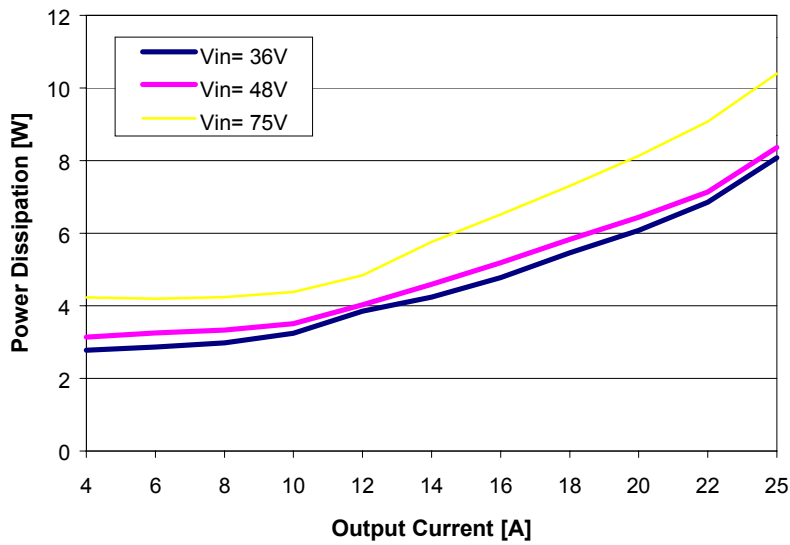

FIGURE 11: Power dissipation vs. load current for listed input voltages at 25°C

HEQB-25A-48V-3.3V

FIGURE 12: Maximum output power derating curves vs. ambient air temperature for airflow rates of 100 LFM through 400 LFM with air flowing across the converter from pin 1 to pin 3 (Transversal) at nominal input voltage.

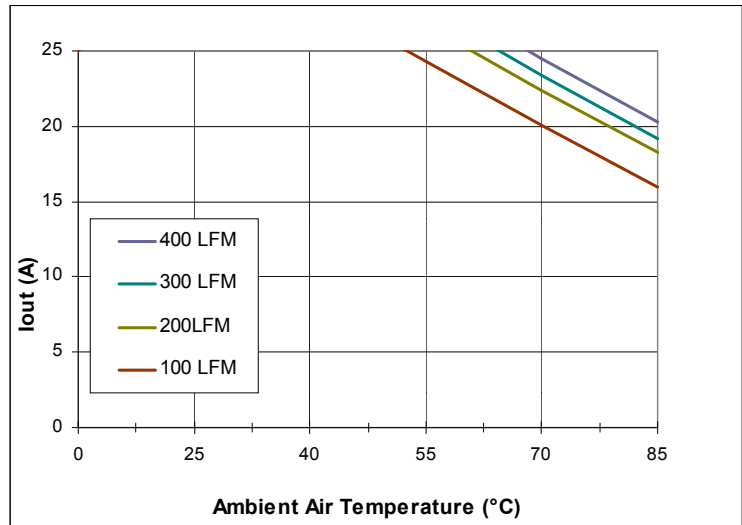
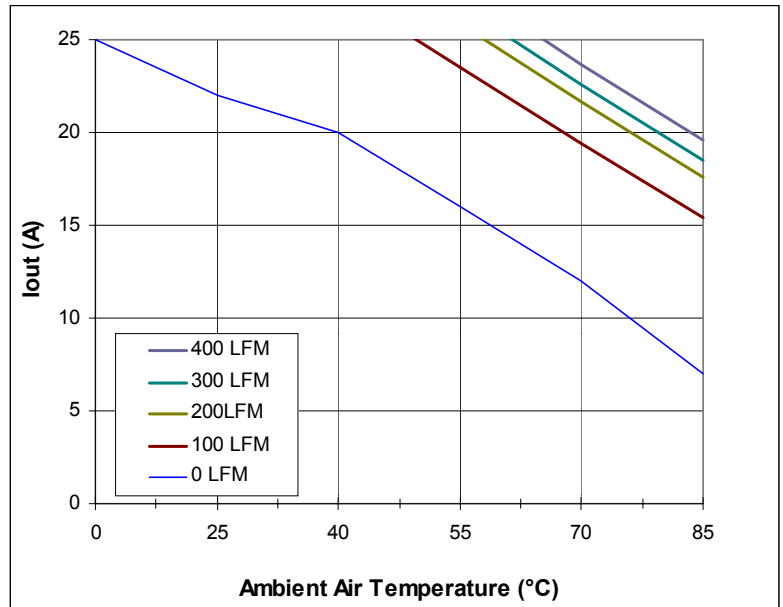

FIGURE 13: Maximum output current derating curves vs. ambient air temperature. Airflow rates of 0 LFM through 400 LFM with air flowing lengthwise from output to input at nominal input voltage.



HEQB-25A-48V-3.3V

Features and Pins description

REMOTE ON-OFF CONTROL

The default logic is negative, where the Remote On/Off (pin 2) input is referenced to -Vin (pin 1). The Remote On/Off signal must be lower than 0.8V to enable the output voltage, and higher than 2.7V to disable the output voltage. Positive logic is an available option, add “-P” to the end of the ordering code.

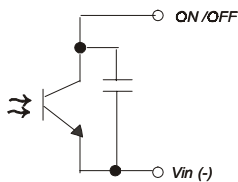

Remote Enable Circuit

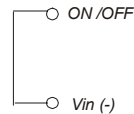

Negative logic
(permanently Enabled)

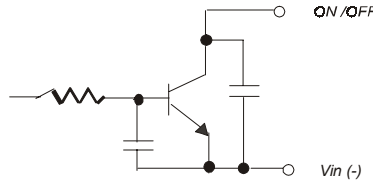

Open Collector Enable Circuit

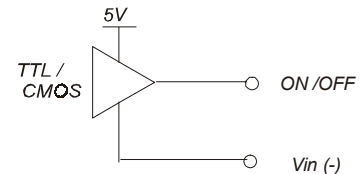

Direct Logic Drive

TRIM

The output voltage can be trimmed by means of an external resistor connected between Trim (pin 6) and +Sense (pin 5) or -Sense (pin 7). The selection of the resistor follows the industry standard trim equation.

An external resistor connected between Trim and -Sense pins will decrease the output voltage. For a decrease of $\Delta\%$ of the nominal output voltage, calculate the value of the external resistor using the following equation:

$$R_{\text{trim-down}} = \left(\frac{511}{\Delta\%} \right) - 10.22k\Omega \quad \text{where} \quad \Delta = \left(\frac{3.3 - V_{\text{target}}}{3.3} \right) \times 100\%$$

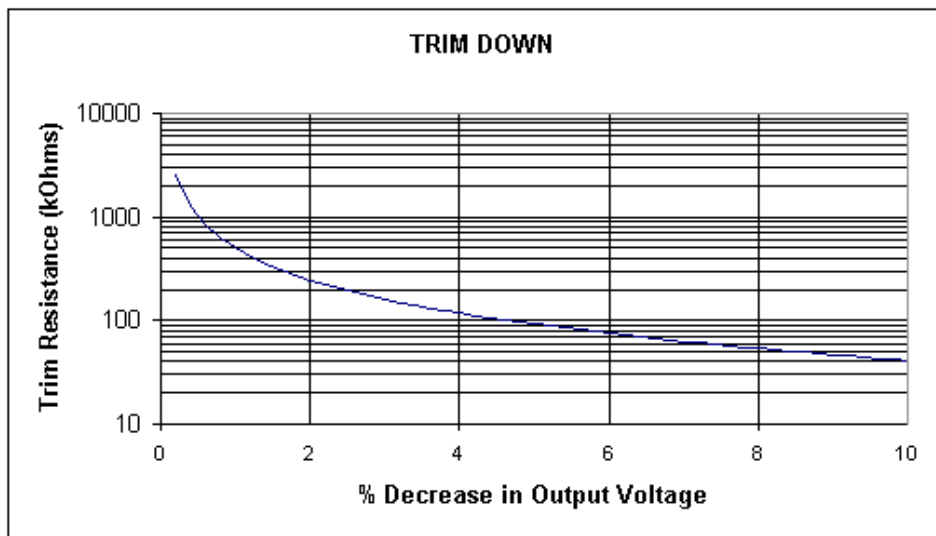

HEQB-25A-48V-3.3V

An external resistor connected between Trim and +Sense pins will increase the output voltage. For an increase of $\Delta\%$ of the nominal output voltage, calculate the value of the external resistor using the following equation:

$$R_{\text{trim-up}} = \left(\frac{5.11 * 3.3 (100 + \Delta\%)}{1.225 \Delta\%} - \frac{511}{\Delta\%} - 10.22 \right) K\Omega$$

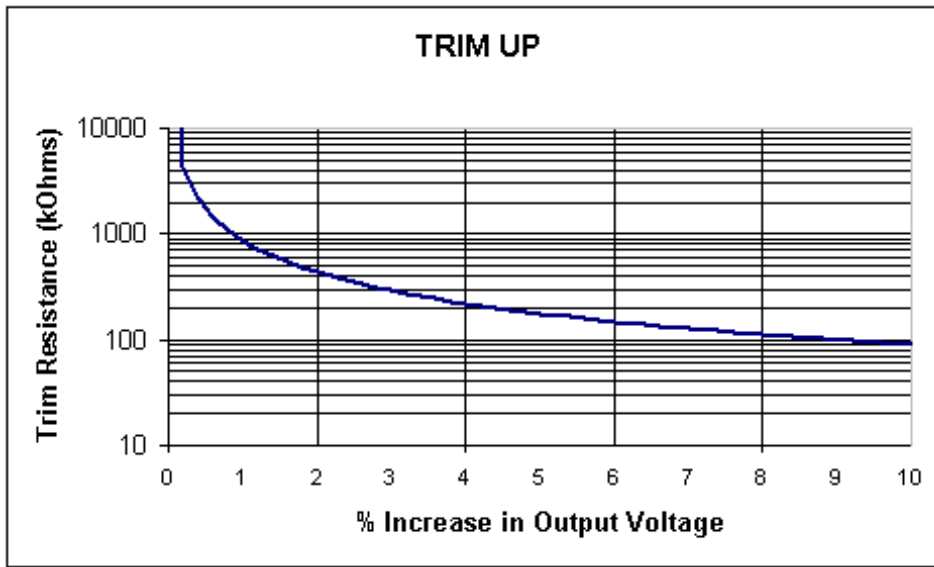

SENSE (+ or -)

The +Sense or -Sense pins must be connected to the load or output pins of the converter. To ensure tight regulation at the system critical load, then the remote sense pins should be connected to the system critical load. Reference applicable section of data sheet for maximum voltage compensation.

Ensure sufficient margin to the over voltage threshold, review applicable sections of the data sheet and system loading: output over-voltage protection -Vs- system transient load condition(s).

HEQB-25A-48V-3.3V

THERMAL CONSIDERATIONS

The converter has internal thermal protection preventing hot spots on PCB from exceeding MFR's recommended temperatures for reliable operation, reference over temperature protection threshold (Section: Feature Characteristics). Margin to the temperature protection limit should be verified in the application, and should not exceed 120°C on the thermal reference points as shown in Figure 14.

During an abnormal condition inducing an increase in the converter temperature, the converter output voltage will fold back when the over temperature protection threshold is reached. The converter will auto-recover when the fault condition is corrected and time allowed for the converter to cool down.

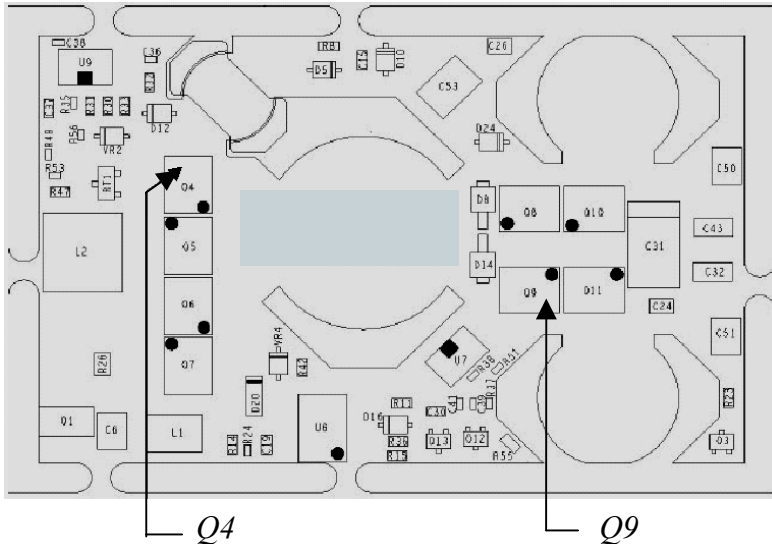

Figure 14, Thermal reference points

OVER CURRENT PROTECTION

The overcurrent limit inception is typically 110% of the rated output current. When the overcurrent limit inception is exceeded the output voltage will decrease proportional to the increase in the load current. Further increase in the load current will cause the output voltage to trip the under voltage protection threshold and enter fault protection, or hiccup reference Figure 5. The converter will enter fault protection typically at 125% of rated output current. When the fault is removed the converter will auto recover.

HEQB-25A-48V-3.3V

Ordering code

Family Code	Rated Output Current	Input Voltage	Output Voltage	Option 1- Remote On/Off Logic	Option 2- Mechanical	Option 3- PIN Length
<i>HEQB</i>	<i>25A</i>	<i>48V</i>	<i>3.3V</i>	<i>Default → Negative Logic P → Positive Logic</i>	<i>Default → Open Frame PL → Cold Plate</i>	<i>Default → 0.15" 1 → 0.25" 2 → 0.11" 3 → 0.18"</i>

Example: HEQB-25A-48V-3.3V-PPL1, Standard quarter brick with Positive Logic, Cold Plate, and 0.25" PIN Length.

Europe
Magnetek S.p.a
 Via S. Giorgio 642
 52028- Terranuova Bracciolini, Arezzo, Italy
 Phone: (+39) 055.9195.1
 Fax: (+39) 055.9195.248

US
Magnetek PEG
 8966 Mason Avenue
 Chatsworth, CA 91311, USA
 Phone: (+1) 818.727.2216
 Fax: (+1) 818.727.2276
 Toll-Free Number: (+1) 800.621.0733