

Not Recommended for New Design, use AH276Q



ATC

Complementary Output Hall Effect Latch

ATS276/277

■ Features

- On-chip Hall sensor with two different sensitivity and hysteresis settings for ATS276/277
- 3.5V to 20V operating voltage
- 400mA (avg) output sink current
- Built-in protecting diode only for chip reverse power connecting
- -20°C to 85°C operating temperature
- Low profile 4 pin SIP package

■ Applications

- Dual-coil Brush-less DC Motor
- Dual-coil Brush-less DC Fan
- Revolution Counting
- Speed Measurement

■ General Description

ATS276/277 are integrated Hall sensors with output drivers, mainly designed for electronic commutation of brush-less DC Fan. This IC internally includes the regulator, protecting diode, Hall plate, amplifier, comparator, and a pair of complementary open-collector outputs (**DO**, **DOB**).

While the magnetic flux density (**B**) is larger than operate point (**Bop**), **DO** will turn on (low), and meanwhile **DOB** will turn off (high). Each output is latched until **B** is lower than release point (**Brp**), and then **DO** \ **DOB** transfer each state.

For DC fan application, sometimes need to test power reverse connection condition. Internal diode only protects chip-side but not for coil-side. If necessary, add one external diode to block the reverse current from coil-side.

■ Ordering Information

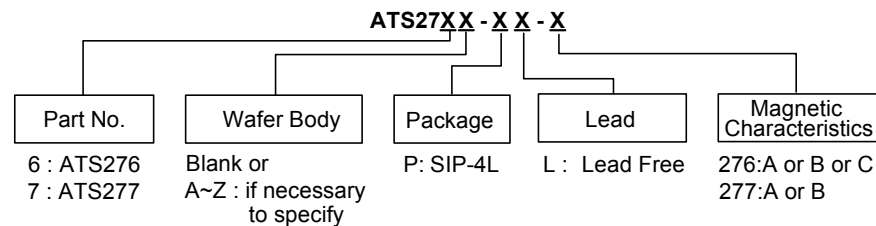

*Packing: Bulk

■ Typical Application Circuit

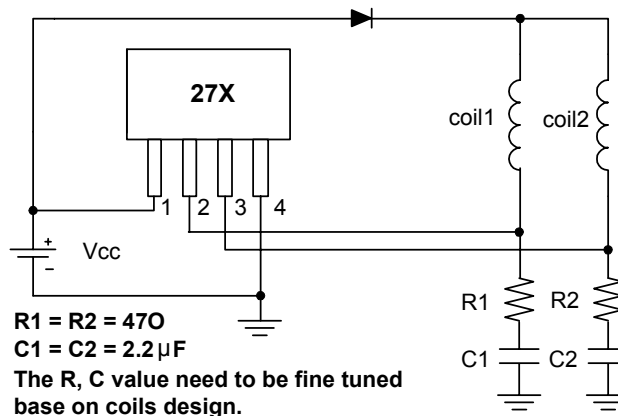

Brush-less DC Fan

Not Recommended for New Design, use AH276Q



Complementary Output Hall Effect Latch

ATS276/277

■ Block Diagram

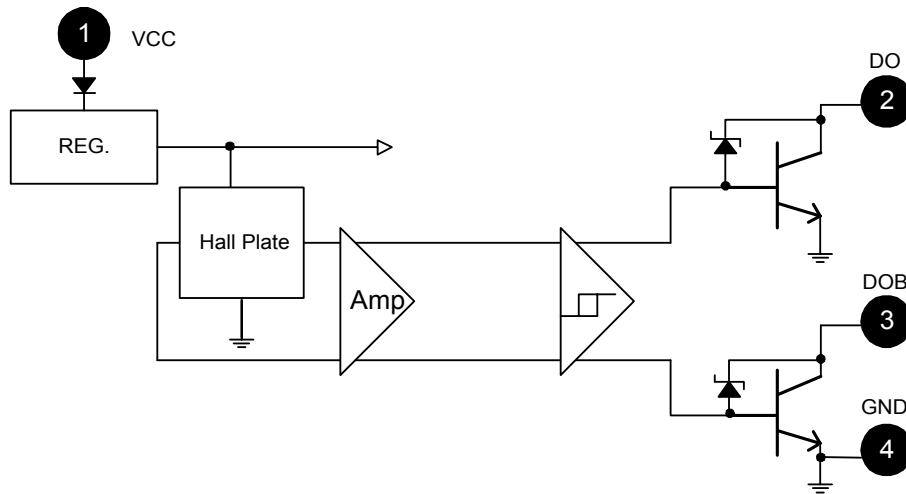

■ Pin Assignment

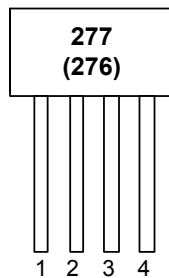

Front View

1 : VCC

2 : DO

3 : DOB

4 : GND

Name	P/I/O	Pin #	Description
Vcc	P	1	Power Supply Input
DO	O	2	Output Pin
DOB	O	3	Output Pin
GND	P	4	Ground

Not Recommended for New Design, use AH276Q



Complementary Output Hall Effect Latch

ATS276/277

■ Absolute Maximum Ratings (at Ta=25°C)

Characteristics		Symbol	Values	Unit
Supply voltage		V _{CC}	20	V
Reverse V _{CC} Polarity Voltage		V _{RCC}	-20	V
Magnetic flux density		B	Unlimited	
Output "on" current	Continuous	I _c	0.4	A
	Hold		0.5	
	Peak (Start Up)		0.7	
Operating temperature range		T _a	-20~+85	°C
Storage temperature range		T _s	-65~+150	°C
Package Power Dissipation		PD	550	mW
Maximum Junction Temp		T _j	150	°C

■ Electrical Characteristics (T=+25°C V_{cc} = 4.0V to 20V)

Characteristic	Symbol	Conditions	Min	Typ	Max	Units
Low Supply Voltage	V _{ce}	V _{cc} =3.5V, I _L =100mA		0.4		V
Supply Voltage	V _{cc}		3.5		20	V
Output Zener Breakdown*	V _z			46		V
Output Saturation Voltage	V _{ce(sat)}	V _{cc} =14V, I _L =300mA		0.3	0.6	V
Output Leakage Current	I _{cex}	V _{ce} =14V, V _{cc} =14V		<0.1	10	μA
Supply Current	I _{cc}	V _{cc} =20V, Output Open		16	25	mA
Output Rise Time	t _r	V _{cc} =14V, R _L =820Ω, C _L =20pF		3.0	10	μs
Output Falling Time	t _f	V _{cc} =14V, R _L =820Ω, C _L =20pF		0.3	1.5	μs
Switch Time Differential	Δt	V _{cc} =14V, R _L =820Ω, C _L =20pF		3.0	10	μs

*Note: The V_z may vary with the inductance/resistance of DC Fan. In order to reduce the risk of dynamic operation, the capacitor/resistor is recommended to add below the DO/DOB as Application Circuit (on page 1).

■ Test Circuit

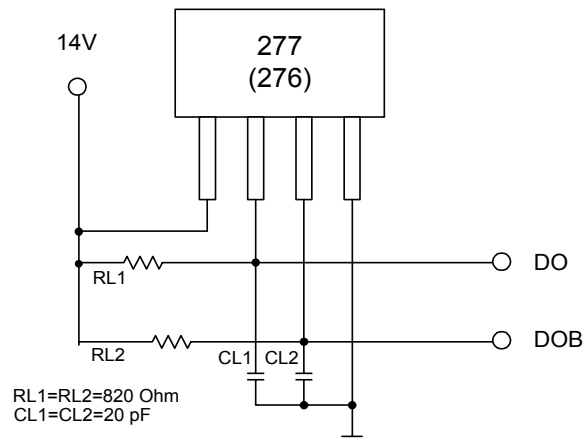

Not Recommended for New Design, use AH276Q



Complementary Output Hall Effect Latch

ATS276/277

■ Magnetic Characteristics(Ta=+25°C)

(1mT=10 Gauss)

A grade

Characteristic		Symbol	Min.	Typ.	Max.	Unit
Operate Point	ATS276	Bop	10	-	50	Gauss
	ATS277		10	-	50	
Release Point	ATS276	Brp	-50	-	-10	Gauss
	ATS277		-50	-	-10	
Hysteresis	ATS276	Bhy	-	75	-	Gauss
	ATS277		-	75	-	

B grade

Characteristic		Symbol	Min.	Typ.	Max.	Unit
Operate Point	ATS276	Bop	5	-	70	Gauss
	ATS277		5	-	70	
Release Point	ATS276	Brp	-70	-	-5	Gauss
	ATS277		-70	-	-5	
Hysteresis	ATS276	Bhy	-	75	-	Gauss
	ATS277		-	75	-	

C grade

Characteristic		Symbol	Min.	Typ.	Max.	Unit
Operate Point	ATS276	Bop	-	-	100	Gauss
Release Point	ATS276	Brp	-100	-	-	Gauss
Hysteresis	ATS276	Bhy	-	75	-	Gauss

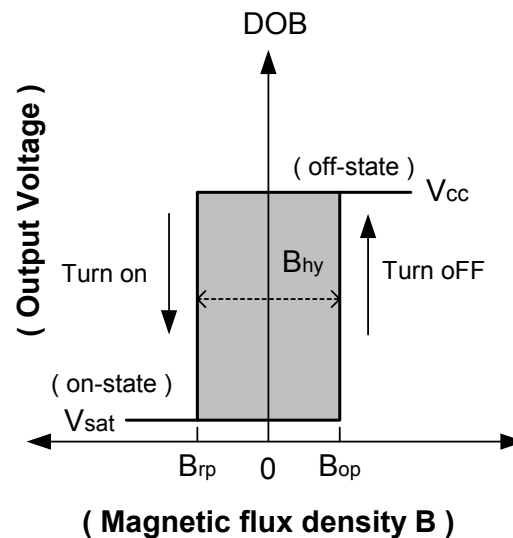
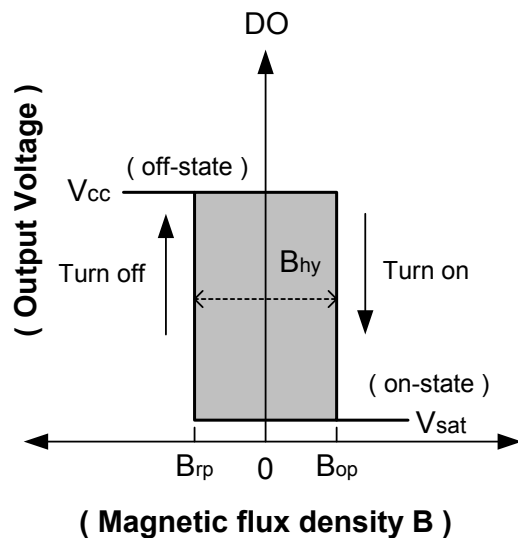

Not Recommended for New Design, use AH276Q



Complementary Output Hall Effect Latch

ATS276/277

■ Performance Characteristics (SIP4)

Ta (°C)	25	50	60	70	80	85	90	95	100
Pd (mW)	550	440	396	352	308	286	264	242	220
Ta (°C)	105	110	115	120	125	130	135	140	150
Pd (mW)	198	176	154	132	110	88	66	44	0

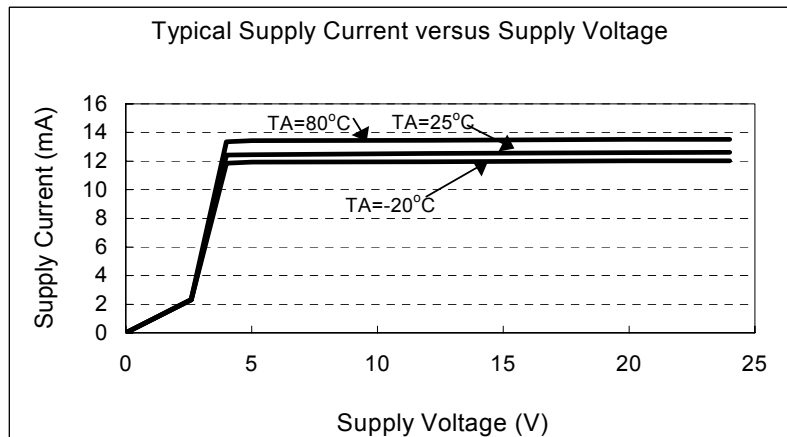
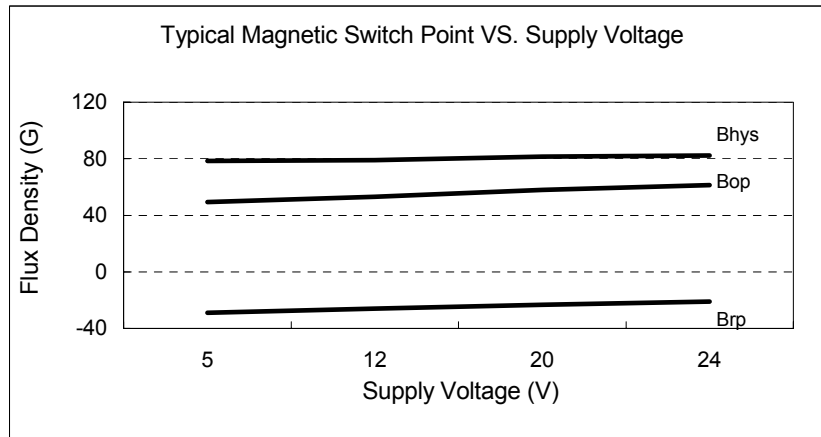
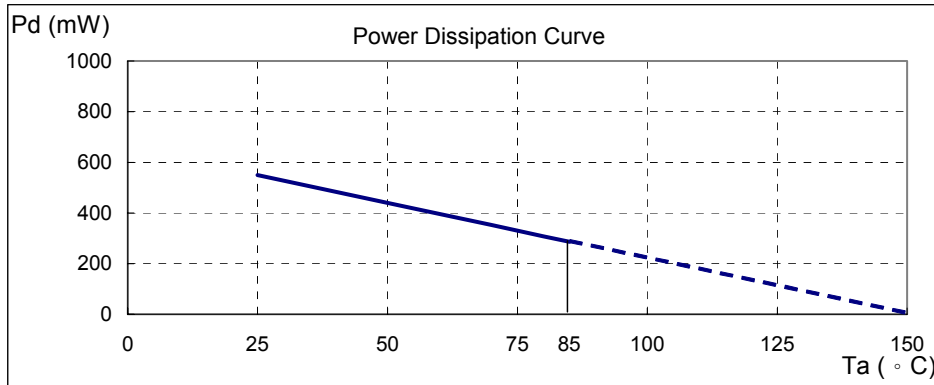

Not Recommended for New Design, use AH276Q



Complementary Output Hall Effect Latch

ATS276/277

■ Operating Characteristics

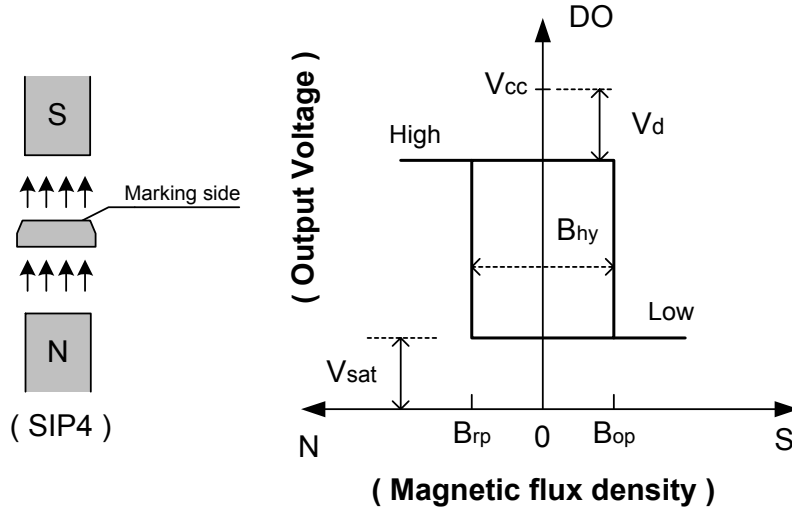

■ Marking Information

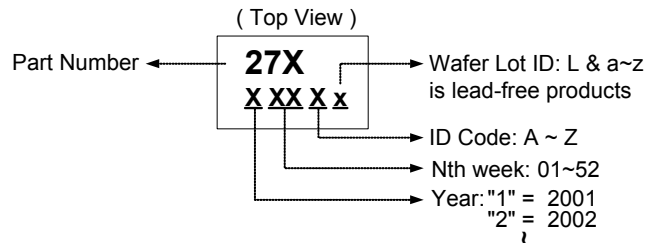

Not Recommended for New Design, use AH276Q



Complementary Output Hall Effect Latch

ATS276/277

■ Package Information

Active Area Depth

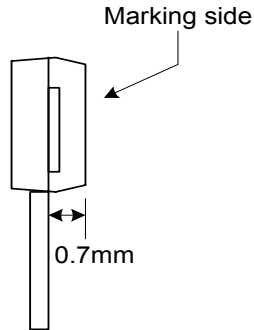

Package Sensor Location

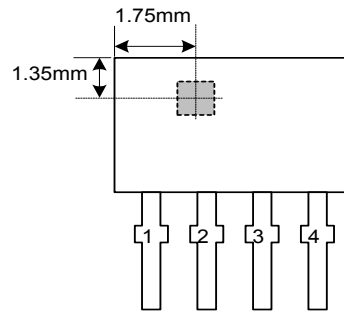

Package Dimension

