



**DC COMPONENTS CO., LTD.**

RECTIFIER SPECIALISTS

**SF51  
THRU  
SF56**

**TECHNICAL SPECIFICATIONS OF SUPER FAST RECTIFIER**

**VOLTAGE RANGE - 50 to 400 Volts**

**CURRENT- 5.0 Amperes**

**FEATURES**

- \* High reliability
- \* Low leakage
- \* Low forward voltage
- \* High current capability
- \* Super fast switching speed
- \* High surge capability
- \* Good for switching mode circuit

**MECHANICAL DATA**

- \* Case: Molded plastic
- \* Epoxy: UL 94V-0 rate flame retardant
- \* Lead: MIL-STD-202E, Method 208 guaranteed
- \* Mounting position: Any
- \* Weight: 1.18 grams



DO-27

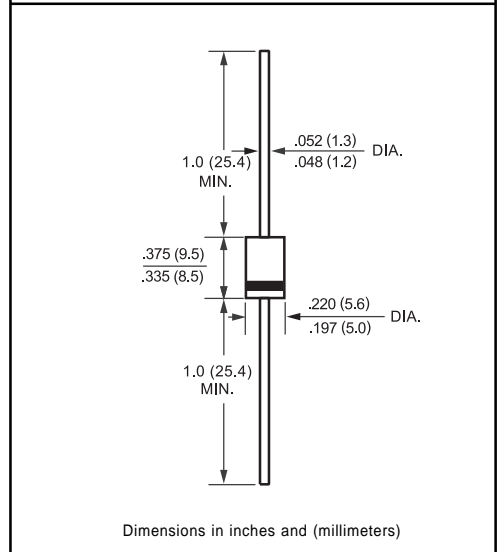

Dimensions in inches and (millimeters)

**MAXIMUM RATINGS AND ELECTRICAL CHARACTERISTICS**

Ratings at 25 °C ambient temperature unless otherwise specified.  
Single phase, half wave, 60 Hz, resistive or inductive load.  
For capacitive load, derate current by 20%.

	SYMBOL	SF51	SF52	SF53	SF54	SF55	SF56	UNITS
Maximum Recurrent Peak Reverse Voltage	VRRM	50	100	150	200	300	400	Volts
Maximum RMS Volts	VRMS	35	70	105	140	210	280	Volts
Maximum DC Blocking Voltage	VDC	50	100	150	200	300	400	Volts
Maximum Average Forward Current at TA = 55°C	Io	5.0						Amps
Peak Forward Surge Current IFM (surge):8.3 ms single half sine-wave superimposed on rated load (JEDEC Method)	IFSM	150						Amps
Maximum DC Reverse Current at Rated DC Blocking Voltage	@TA = 25°C	5.0						uAmps
	@TA =125°C	150						
Maximum Forward Voltage at 5.0A DC	VF	0.95				1.25		Volts
Maximum Reverse Recovery Time (Note 1)	trr	35						nSec
Typical Junction Capacitance (Note 2)	CJ	50				30		pF
Operating and Storage Temperature Range	TJ, TSTG	-65 to + 150						°C

NOTES : 1. Test Conditions: IF=0.5A, IR=1.0A, IRR=0.25A.  
2. Measured at 1 MHz and applied reverse voltage of 4.0 volts.

# RATING AND CHARACTERISTIC CURVES ( SF51 THRU SF56 )

FIG. 1 - TEST CIRCUIT DIAGRAM AND REVERSE RECOVERY TIME CHARACTERISTIC

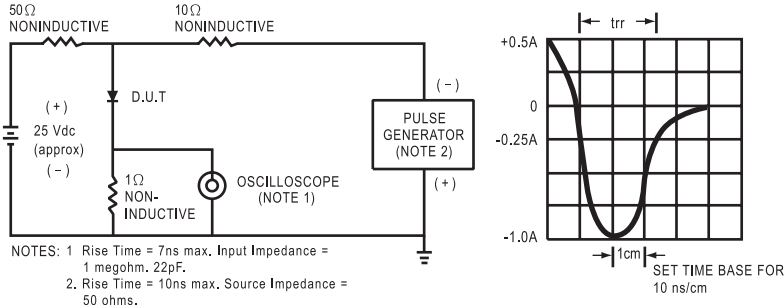

FIG. 2 - TYPICAL FORWARD CURRENT DERATING CURVE

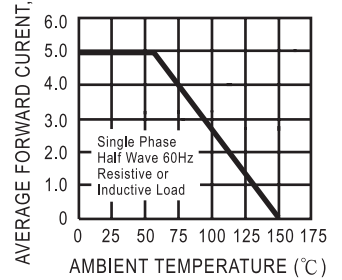

FIG. 3 - TYPICAL REVERSE CHARACTERISTICS

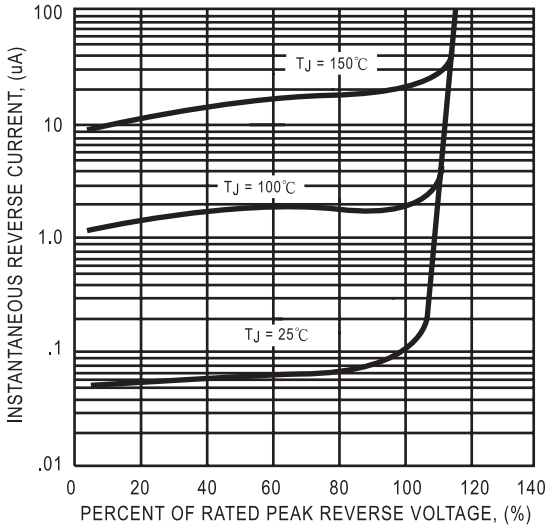

FIG. 4 - TYPICAL INSTANTANEOUS FORWARD CHARACTERISTICS

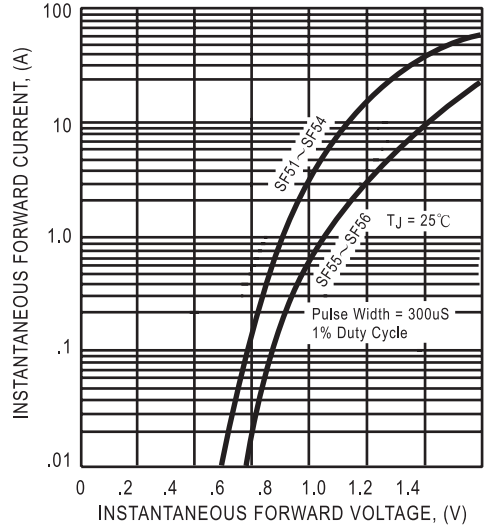

FIG. 5 - MAXIMUM NON-REPETITIVE FORWARD SURGE CURRENT

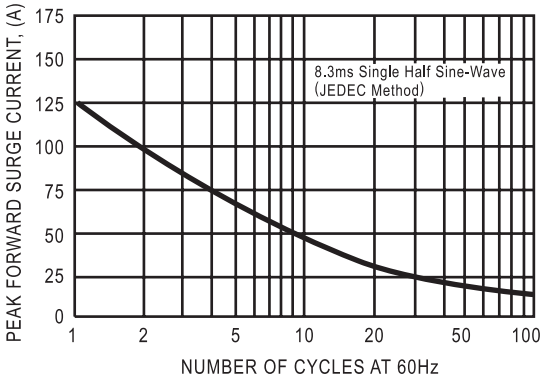
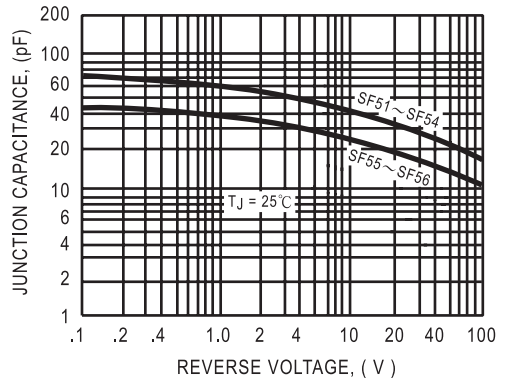

FIG. 6 - TYPICAL JUNCTION CAPACITANCE



DC COMPONENTS CO., LTD.