

### Features

- Two-stage LNA
- 28 dB gain & 1.1 dB NF at 1575 MHz
- Unconditionally Stable
- Need only 5 components
- 3 kV Contact Discharge ESD Rating achievable with one external L (Refer to an application circuit at page 7)

### Description

ASL226 is a two-stage LNA for GPS receiver low noise block. It has a low noise, high gain, and high linearity over a wide range of frequency up to 6 GHz. It is also suitable for use in the low noise amplifier block of the mobile wireless systems of T-DMB, CDMA, GSM, PCS, WCDMA, WiBro, WiMAX, and WLAN so on. The amplifier is available in an SOT-363 package and passes the stringent DC, RF, and reliability tests.

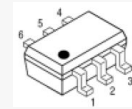

Package Style: SOT-363

### Typical Performance

Parameters	Units	Typical									
		1575	1575	1575	1575	900	1950	2450	3500	5800	
Frequency	MHz	1575	1575	1575	1575	900	1950	2450	3500	5800	
Gain	dB	23.5	28	28.5	30.5	34	25	21.5	15	11.5	
S11	dB	-14	-16	-20	-11	-14	-15	-16	-16	-20	
S22	dB	-12	-15	-20	-14	-15	-20	-16	-12	-20	
S12	dB	-40	-40	-40	-40	-40	-35	-30	-30	-25	
Output IP3 <sup>1)</sup>	dBm	11	15.5	17	20	18	16.5	14	10	16.5	
Noise Figure	dB	1.2	1.1	0.95	1.0	1.3	1.3	1.3	1.8	2.0	
Output P1dB	dBm	9	11	11	11	9	10.5	11	8	9	
Current	mA	5.5	8.5	9.5	18	8.5	8.5	8.5	8.5	8.5	
Device Voltage	V	2.2	3	3.3	5	3	3	3	3	3	

1) OIP3 is measured with two tones at an output power of -10 dBm/tone separated by 1MHz.

### Product Specifications\*

Parameters	Units	Min	Typ	Max
Frequency	MHz		1575	
Gain	dB	27	28	
S11	dB		-16	
S22	dB		-15	
S12	dB		-40	
Output IP3	dBm	14	15.5	
Noise Figure	dB		1.1	1.3
Output P1dB	dBm	9	11	
Current	mA	5.5	8.5	11
Device Voltage	V		3	

\* 100% in-house DC & RF testing is done on packaged products before taping.

### Absolute Maximum Ratings

Parameters	Rating
Operating Case Temperature	-40 to +85°C
Storage Temperature	-40 to +150°C
Device Voltage	+5 V
Operating Junction Temperature	+150°C
Input RF Power (CW, 50ohm matched)*	22 dBm

\* Please find the max. input power data from [http://www.asb.co.kr/pdf/Maximum\\_Input\\_Power\\_Analysis.pdf](http://www.asb.co.kr/pdf/Maximum_Input_Power_Analysis.pdf)

### Application Circuit

- 1575 MHz (1.8V)
- 1575 MHz (2.2V)
- 1575 MHz (3.3V)
- 1575 MHz (NF=0.95dB, 3.3V)
- 1575 MHz (Gain>30dB, 5V)
- 1575 MHz (Robust ESD / ± 3 kV)
- 1575 MHz (2.85V / 20dB Gain)
- 1575 MHz (With SAW Filter)
- 1176.45 MHz
- 1163~1210 / 1204~1240 MHz
- 1558~1577 MHz
- 1227 MHz
- 900 MHz
- 1950 MHz
- 2450 MHz
- 2300~2900 MHz
- 2300~2900 MHz (Low Gain)
- 3300 ~ 3800MHz
- 4000~4500 MHz
- 5800 MHz

### Pin Configuration

Pin No.	Function
1	VDD
2,4,5	GND
3	RF OUT
6	RF IN

### Outline Drawing

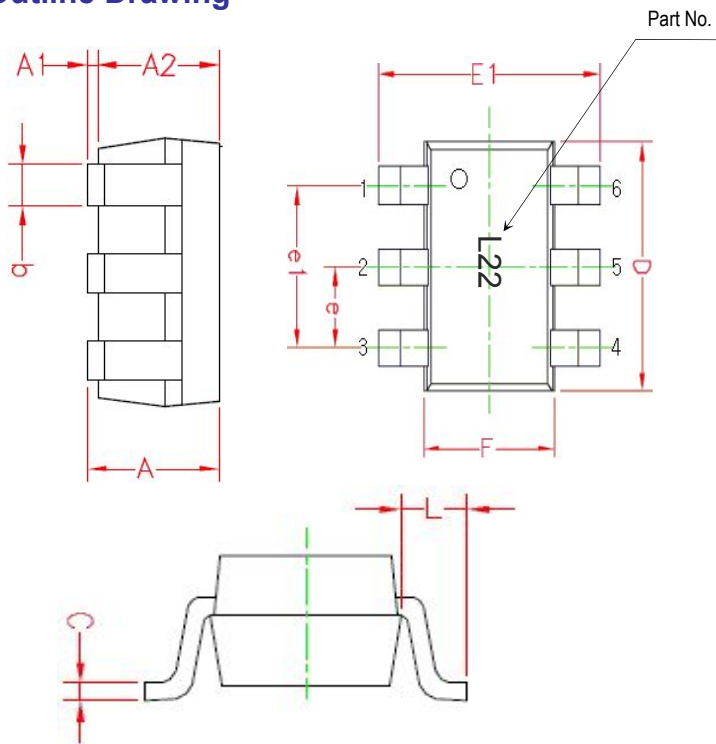

Symbols	Dimensions (In mm)		Dimensions (In inch)	
	MIN	MAX	MIN	MAX
A	0.90	1.10	.036	.044
A1	0.025	0.10	.001	.004
A2	0.875	1.00	.035	.040
b	0.20	0.40	.008	.016
C	0.10	0.15	.004	.006
D	1.90	2.10	.076	.084
E	1.15	1.35	.046	.054
E1	2.00	2.20	.080	.088
e	0.65 BSC.		.026 BSC.	
e1	1.30 BSC.		.052 BSC.	
L	0.425 REF.		.017 REF..	

Pin No.	Function	Pin No.	Function.
1	VDD	4	GND
2	GND	5	GND
3	RF OUT	6	RF IN

### Mounting Recommendation(in mm)

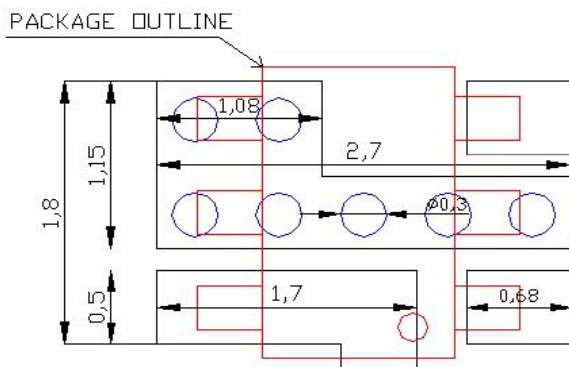

- Note:**
1. The number and size of ground via holes in a circuit board is critical for thermal and RF grounding considerations.
  2. We recommend that the ground via holes be placed on the bottom of lead pin 2,4 and 5 for better RF and thermal performance, as shown in the drawing at the left side.
  3. You can download the gerber file of ASL226 from [http://www.asb.co.kr/s-para/ASL226\\_gerber.zip](http://www.asb.co.kr/s-para/ASL226_gerber.zip)

### ESD Classification & Moisture Sensitivity Level

#### ESD Classification

HBM	Class 0
	Voltage Level: 200 V
MM	Class A
	Voltage Level: 40 V

CAUTION: ESD-sensitive device!

#### Moisture Sensitivity Level (MSL)

Level 3 at 260°C reflow

### APPLICATION CIRCUIT

GPS

1575 MHz

+1.8 V

Parameter	Symbol	Test Conditions	MIN.	TYP.	MAX.	Unit
Power Gain	$G_p$	F = 1.575 GHz		23.5		dB
Noise Figure	NF	F = 1.575 GHz		1.1		dB
Input Return Loss	$RL_{in}$	F = 1.575 GHz		-14		dB
Output Return Loss	$RL_{out}$	F = 1.575 GHz		-16		dB
Reverse Isolation	ISO	F = 1.575 GHz		-35		dB
1 dB Gain Compression Output Power	$P_{o(1dB)}$	F = 1.575 GHz		6		dBm
3 <sup>rd</sup> Intercept Point Output Power <sup>1)</sup>	OIP3	F = 1.575 GHz		14		dBm
Current	$I_{cc}$	F = 1.575 GHz, Non-RF		6.5		mA

1) OIP3 is measured with two tones at an output power of -10 dBm/tone separated by 1MHz.

### Schematic

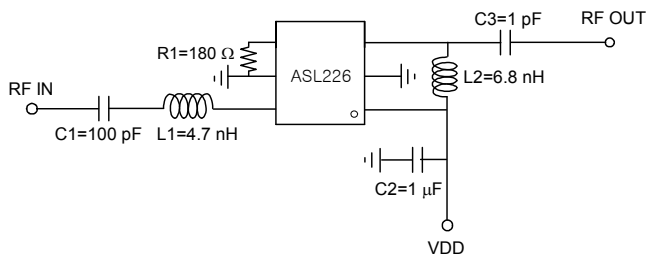

\* Note: C2 must be placed as close as possible to the device.

### Board Layout (FR4, 14x11.3 mm<sup>2</sup>, 0.8T)

Top

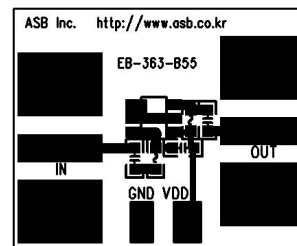

Bottom



### S-parameters

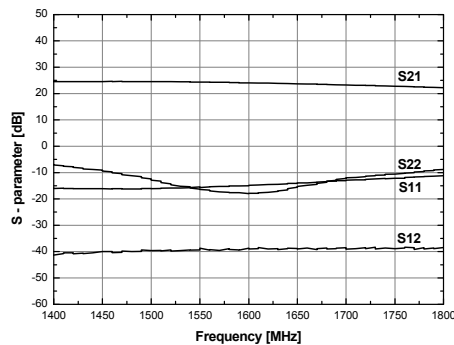

### Gain & OIP3 & P1 & NF Vs. R1

R1 (ohm)	Vd (V)	Ic (mA)	Gain (dB)	OIP3 (dBm)	P1 (dBm)	NF (dB)
180	1.8	6.5	24.2	14.3	6.4	1.03
160	1.8	6	23.9	14	7	1.05
120	1.8	5.5	23.6	13.1	7.2	1.07
100	1.8	5	23.5	12.6	7.3	1.09

### APPLICATION CIRCUIT

GPS

1575 MHz

+2.2 V

Parameter	Symbol	Test Conditions	MIN.	TYP.	MAX.	Unit
Power Gain	$G_p$	F = 1.575 GHz		23.5		dB
Noise Figure	NF	F = 1.575 GHz		1.2		dB
Input Return Loss	$RL_{in}$	F = 1.575 GHz		-14		dB
Output Return Loss	$RL_{out}$	F = 1.575 GHz		-12		dB
Reverse Isolation	ISO	F = 1.575 GHz		-40		dB
1 dB Gain Compression Output Power	$P_{o(1dB)}$	F = 1.575 GHz		9		dBm
3 <sup>rd</sup> Intercept Point Output Power <sup>1)</sup>	OIP3	F = 1.575 GHz		11		dBm
Current	$I_{cc}$	F = 1.575 GHz, Non-RF		5.5		mA

1) OIP3 is measured with two tones at an output power of -10 dBm/tone separated by 1MHz.

### Schematic

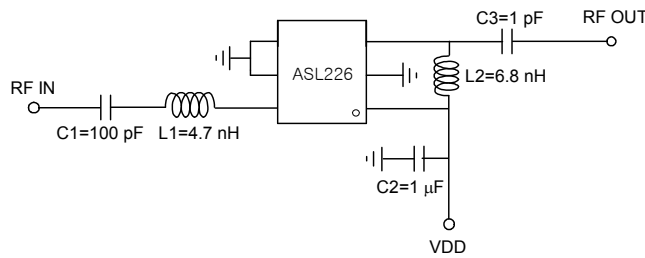

\* Note: Gain and current can be reduced by controlling VDD to 2 V.  
C2 must be placed as close as possible to the device.

### Board Layout (FR4, 14x11.3 mm<sup>2</sup>, 0.8T)

Top

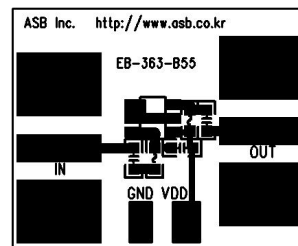

Bottom

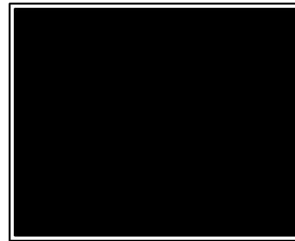

### S-parameters & K-factor

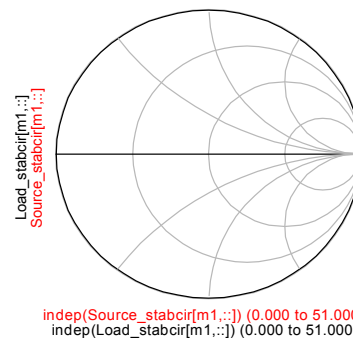
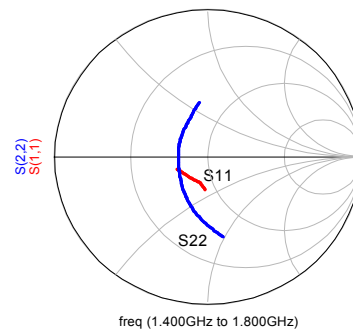
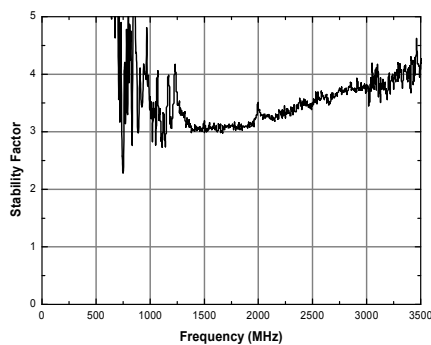
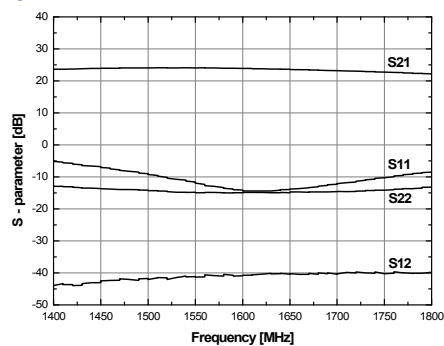

indep(Source\_stabcir[m1,:]) (0.000 to 51.000)  
indep(Load\_stabcir[m1,:]) (0.000 to 51.000)

### APPLICATION CIRCUIT

GPS

1575 MHz

+3.3 V

Parameter	Symbol	Test Conditions	MIN.	TYP.	MAX.	Unit
Power Gain	$G_p$	F = 1.575 GHz		20		dB
Noise Figure	NF	F = 1.575 GHz		1.2		dB
Input Return Loss	$RL_{in}$	F = 1.575 GHz		-20		dB
Output Return Loss	$RL_{out}$	F = 1.575 GHz		-16		dB
Reverse Isolation	ISO	F = 1.575 GHz		-40		dB
1 dB Gain Compression Output Power	$P_{o(1dB)}$	F = 1.575 GHz		4		dBm
3 <sup>rd</sup> Intercept Point Output Power <sup>1)</sup>	OIP3	F = 1.575 GHz		3		dBm
Current	$I_{cc}$	F = 1.575 GHz, Non-RF		8.5		mA

1) OIP3 is measured with two tones at an output power of -20 dBm/tone separated by 1MHz.

### Schematic

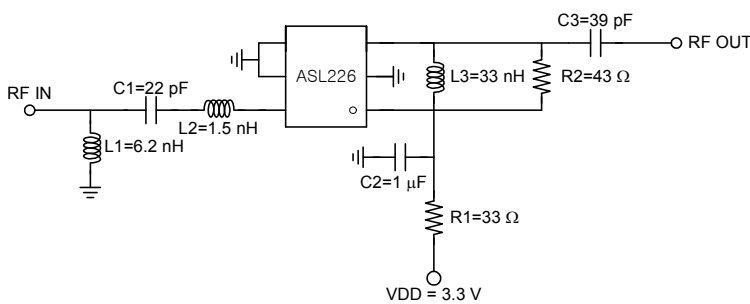

\* Note: Gain and current can be reduced by controlling VDD to 2 V.  
C2 must be placed as close as possible to the device.

### Board Layout (FR4, 14x11.3 mm<sup>2</sup>, 0.8T)

Top

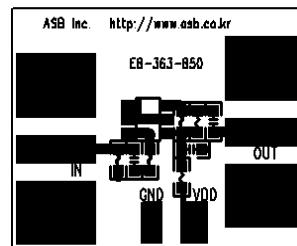

Bottom



### S-parameters & K-factor

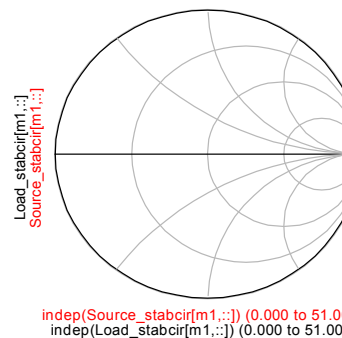
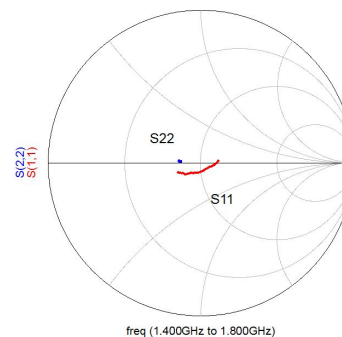
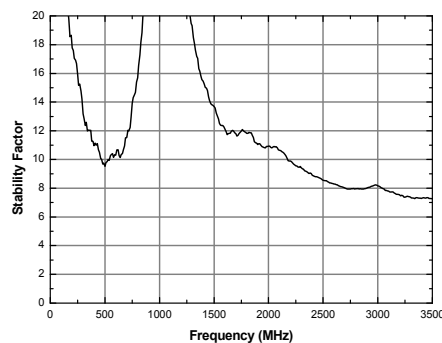
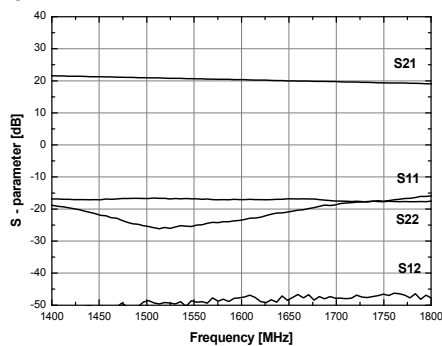

### APPLICATION CIRCUIT

GPS

1575 MHz

+3 V / +3.3 V / +5V

Parameter	Symbol	Test Conditions	TYP			Unit
Power Gain	$G_p$	F = 1.575 GHz	28	28.5	30.5	dB
Noise Figure	NF	F = 1.575 GHz	1.1	0.95	1.0	dB
Input Return Loss	$RL_{in}$	F = 1.575 GHz	-16	-20	-11	dB
Output Return Loss	$RL_{out}$	F = 1.575 GHz	-15	-20	-14	dB
Reverse Isolation	ISO	F = 1.575 GHz	-40	-40	-40	dB
1 dB Gain Compression Output Power	$P_{o(1dB)}$	F = 1.575 GHz	11	11	11	dBm
3 <sup>rd</sup> Intercept Point Output Power	OIP3	F = 1.575 GHz	15.5 <sup>1)</sup>	17 <sup>1)</sup>	20 <sup>2)</sup>	dBm
Device Voltage	Volt	F = 1.575 GHz	3	3.3	5	V
Current	$I_{cc}$	F = 1.575 GHz, Non-RF	8.5	9.5	18	mA

1) OIP3 is measured with two tones at an output power of -10 dBm/tone separated by 1MHz.

2) OIP3 is measured with two tones at an output power of -3 dBm/tone separated by 1MHz.

### Schematic

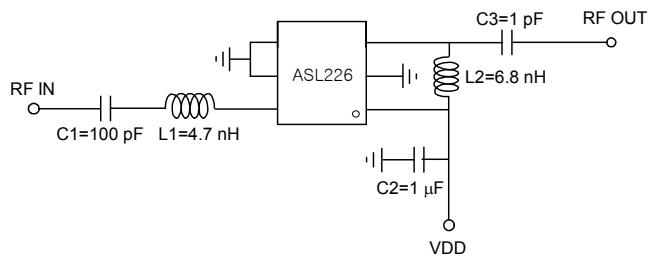

\* Note: Gain and current can be reduced by controlling VDD to 2 V. C2 must be placed as close as possible to the device.

### Board Layout (FR4, 14x11.3 mm<sup>2</sup>, 0.8T)

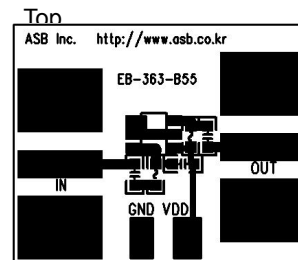

### Bottom



### S-parameters & Noise Figure & K-factor

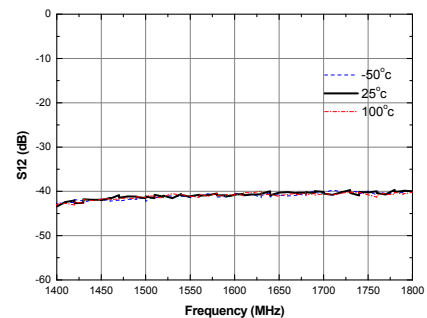
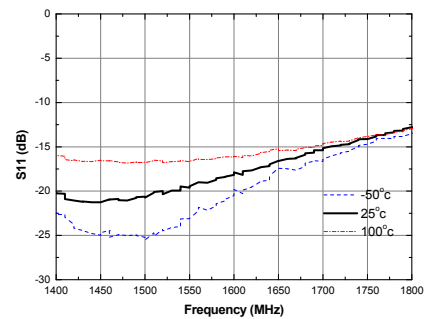
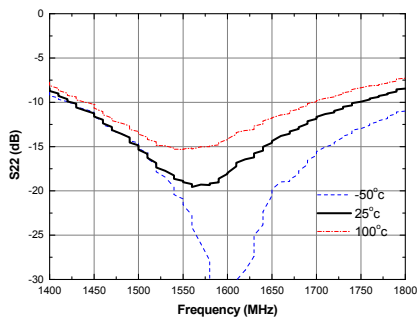
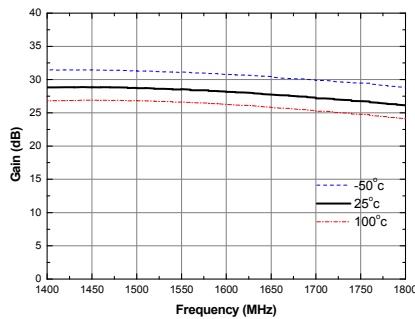

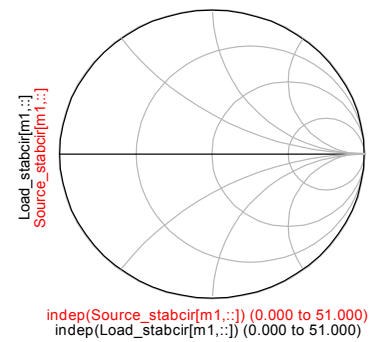
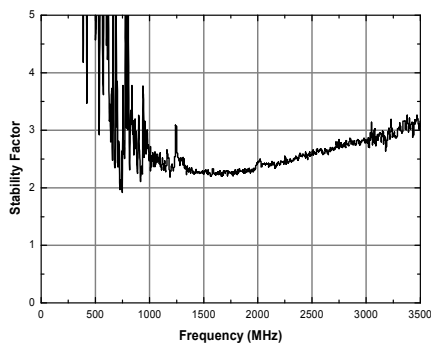
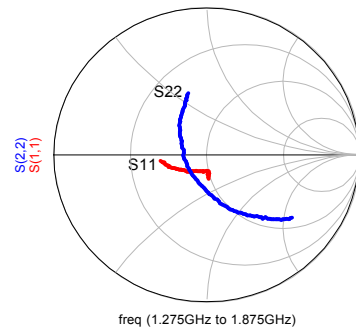
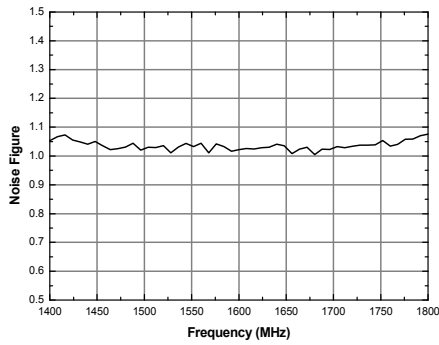

### Current vs. Temperature

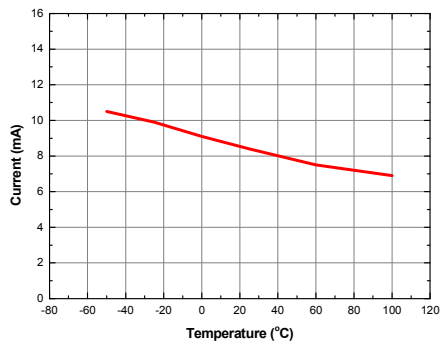

### Gain vs. Temperature

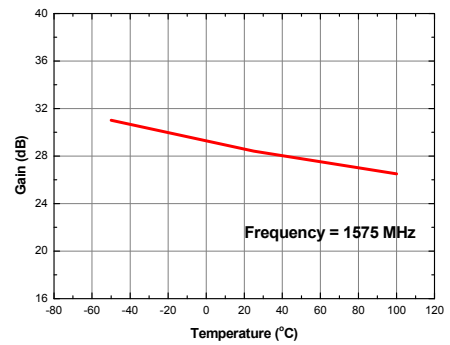

### P1dB vs. Temperature

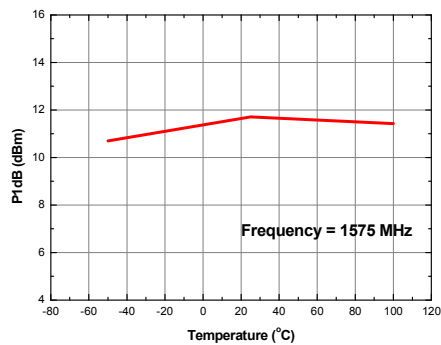

### Output IP3 vs. Tone Power (Frequency = 1575 MHz)

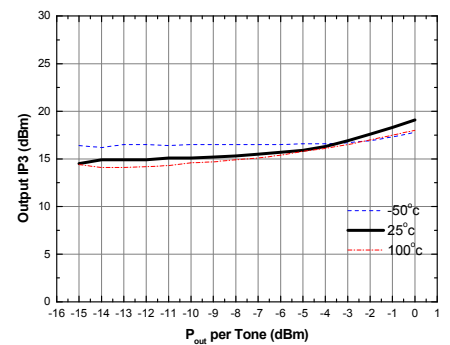

### APPLICATION CIRCUIT

Robust ESD ( $\pm 3$  kV)\*

GPS

1575 MHz

+3 V

Parameter	Symbol	Test Conditions	MIN.	TYP.	MAX.	Unit
Power Gain	$G_p$	F = 1.575 GHz		26		dB
Noise Figure	NF	F = 1.575 GHz		1.2		dB
Input Return Loss	$RL_{in}$	F = 1.575 GHz		-14		dB
Output Return Loss	$RL_{out}$	F = 1.575 GHz		-18		dB
Reverse Isolation	ISO	F = 1.575 GHz		-35		dB
1 dB Gain Compression Output Power	$P_{o(1dB)}$	F = 1.575 GHz		12		dBm
3 <sup>rd</sup> Intercept Point Output Power <sup>1)</sup>	OIP3	F = 1.575 GHz		17		dBm
Current	$I_{cc}$	F = 1.575 GHz, Non-RF		8.5		mA

1) OIP3 is measured with two tones at an output power of -10 dBm/tone separated by 1MHz.

\* Test Method: Contact discharge on GPS patch antenna input. Applying 10 times repeated voltage at 1 sec time interval.

### Schematic

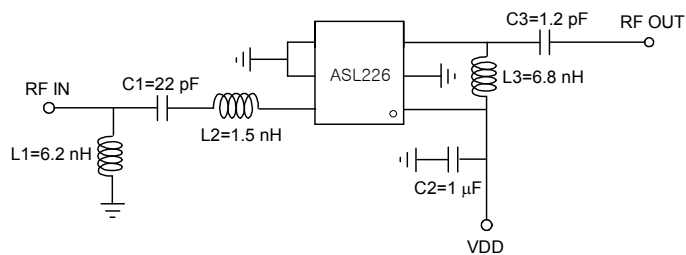

\* Note: Gain and current can be reduced by controlling VDD to 2 V.  
C2 must be placed as close as possible to the device.

### Board Layout (FR4, 14x11.3 mm<sup>2</sup>, 0.8T)

Top

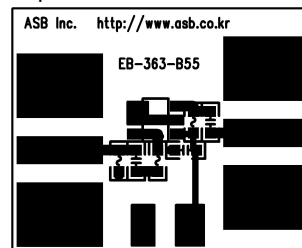

Bottom

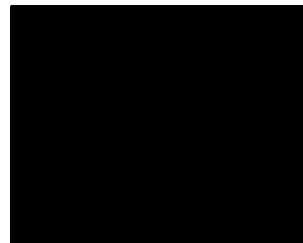

### S-parameters & K-factor

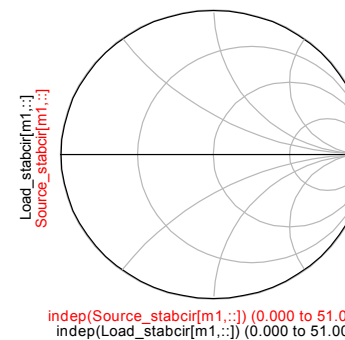
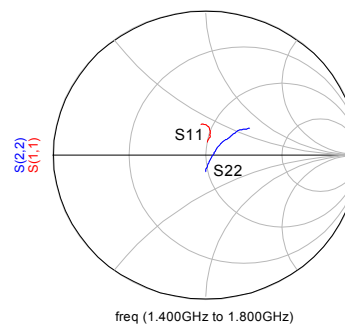
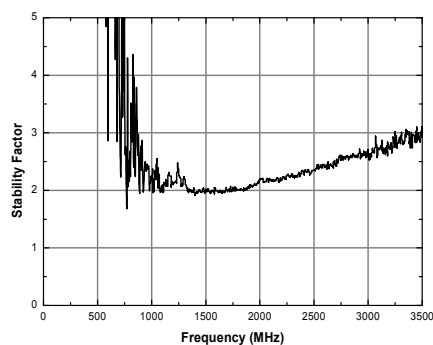
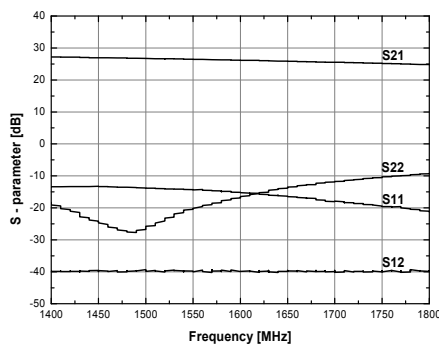



### APPLICATION CIRCUIT

GPS

1575 MHz

+2.85 V /

20dB Gain

Parameter	Symbol	Test Conditions	MIN.	TYP.	MAX.	Unit
Power Gain	$G_p$	F = 1.575 GHz		20		dB
Noise Figure	NF	F = 1.575 GHz		1.6		dB
Input Return Loss	$RL_{in}$	F = 1.575 GHz		-8		dB
Output Return Loss	$RL_{out}$	F = 1.575 GHz		-9		dB
Reverse Isolation	ISO	F = 1.575 GHz		-35		dB
1 dB Gain Compression Output Power	$P_{o(1dB)}$	F = 1.575 GHz		-5		dBm
3 <sup>rd</sup> Intercept Point Output Power <sup>1)</sup>	OIP3	F = 1.575 GHz		5.5		dBm
Current	$I_{cc}$	F = 1.575 GHz, Non-RF		4.0		mA

1) OIP3 is measured with two tones at an output power of -20 dBm/tone separated by 1MHz.

### Schematic

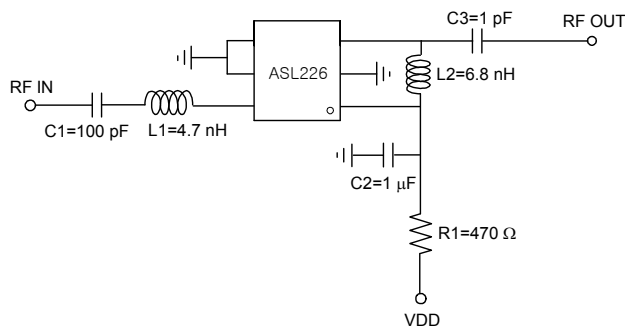

\* Note: Gain and current can be reduced by controlling VDD to 2 V.  
C2 must be placed as close as possible to the device.

### Board Layout (FR4, 14x11.3 mm<sup>2</sup>, 0.8T)

Top

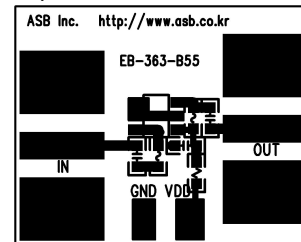

Bottom



### S-parameters & K-factor

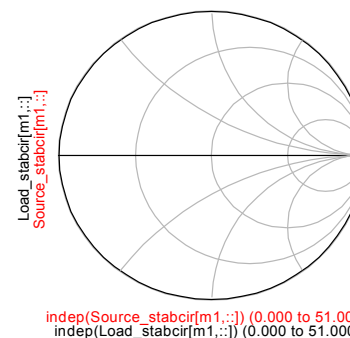
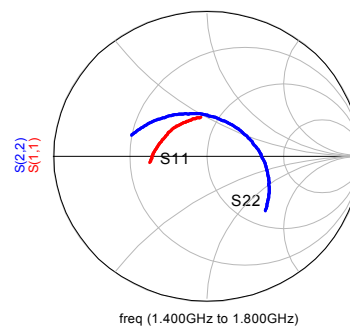
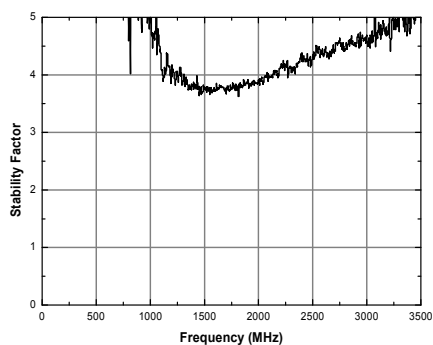
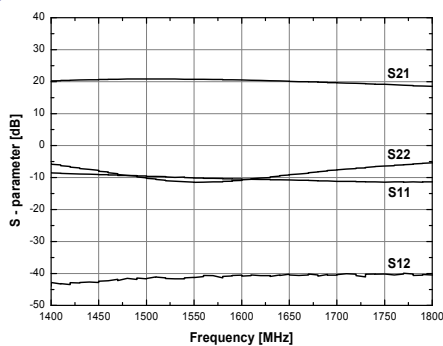

### APPLICATION CIRCUIT ( With SAW Filter )

GPS

1575 MHz

+3 V

Parameter	Symbol	Test Conditions	MIN.	TYP.	MAX.	Unit
Power Gain	$G_p$	F = 1.575 GHz		26.5		dB
Noise Figure	NF	F = 1.575 GHz		1.1		dB
Input Return Loss	$RL_{in}$	F = 1.575 GHz		-18		dB
Output Return Loss	$RL_{out}$	F = 1.575 GHz		-18		dB
Reverse Isolation	ISO	F = 1.575 GHz		-40		dB
1 dB Gain Compression Output Power	$P_{o(1dB)}$	F = 1.575 GHz		11		dBm
3 <sup>rd</sup> Intercept Point Output Power <sup>1)</sup>	OIP3	F = 1.575 GHz		14.5		dBm
Current	$I_{cc}$	F = 1.575 GHz, Non-RF		8.5		mA

1) OIP3 is measured with two tones at an output power of -10 dBm/tone separated by 1MHz.

### Schematic

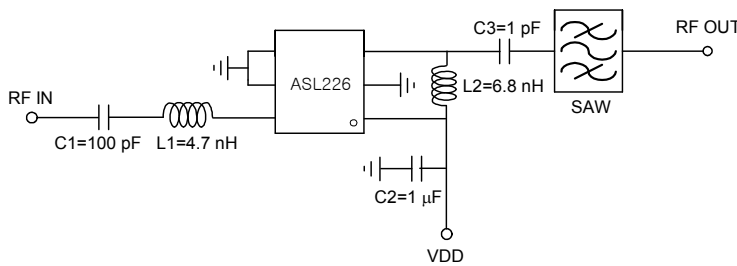

\* Note: Gain and current can be reduced by controlling VDD to 2 V.  
C2 must be placed as close as possible to the device.

### Board Layout (FR4, 15x11.5 mm<sup>2</sup>, 0.8T)

Top

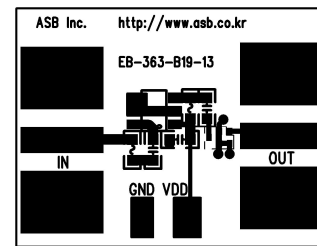

Bottom

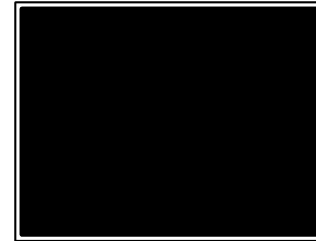

### S-parameters & Noise Figure & K-factor

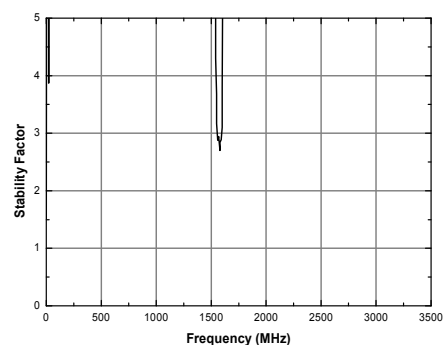
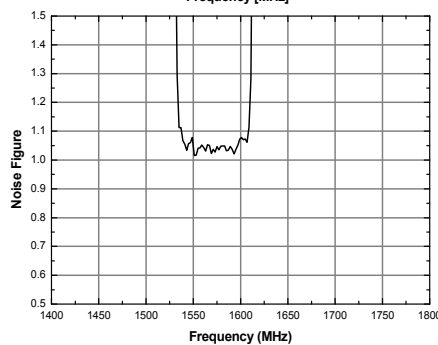
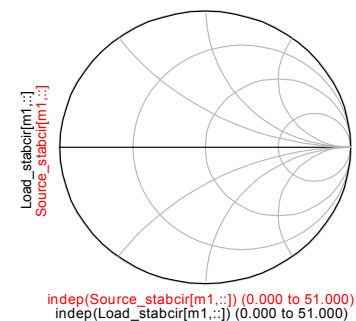
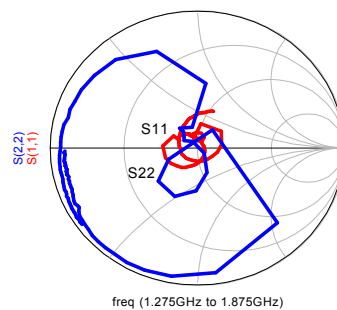
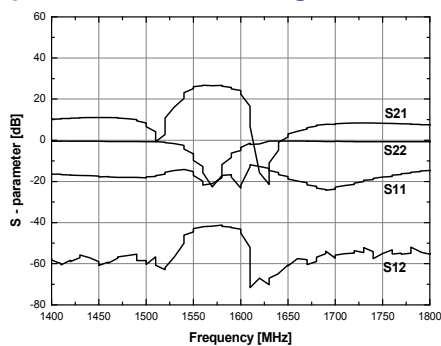

### APPLICATION CIRCUIT

1176.45 MHz /  
1227 MHz  
+3 V

Parameter	Symbol	Unit	Frequency [MHz]	
			1176.45	1227
Power Gain	$G_p$	dB	33	31
Noise Figure	NF	dB	1.1	1.0
Input Return Loss	$RL_{in}$	dB	-20	-15
Output Return Loss	$RL_{out}$	dB	-20	-15
Reverse Isolation	ISO	dB	-40	-40
1 dB Gain Compression	$P_{o(1dB)}$	dBm	9	10.5
Output Power	OIP3	dBm	18	18
3 <sup>rd</sup> Intercept Point				
Output Power <sup>1)</sup>				
Current	$I_{cc}$	mA	8.5	8.5
Device Voltage	$V_{dd}$	V	3	3

1) OIP3 is measured with two tones at an output power of -10 dBm/tone separated by 1MHz.

### Schematic

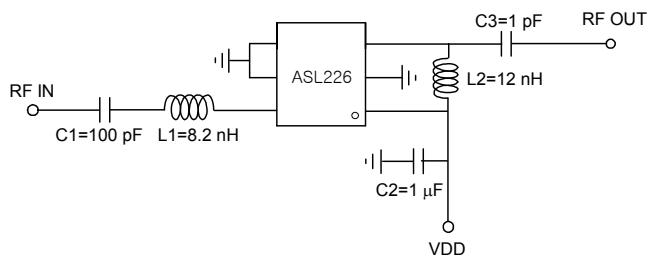

\* Note: Gain and current can be reduced by controlling VDD to 2 V.  
C2 must be placed as close as possible to the device.

### Board Layout (FR4, 14x11.3 mm<sup>2</sup>, 0.8T)

Top

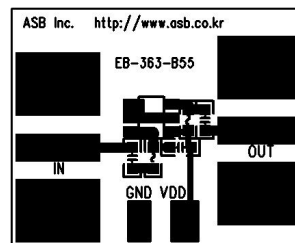

Bottom



### S-parameters & K-factor

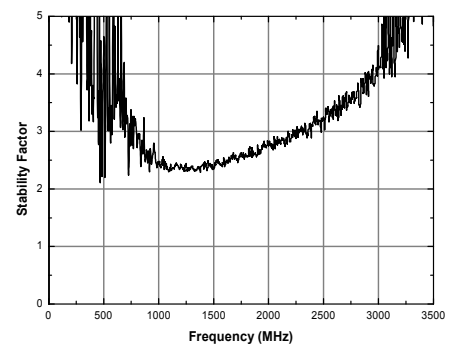
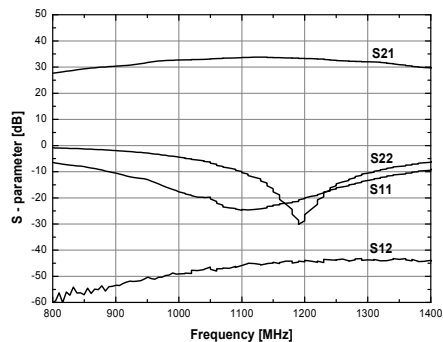

### APPLICATION CIRCUIT

1163 ~ 1210 MHz /  
1204 ~ 1240 MHz  
+3 V

Parameter	Symbol	Unit	Frequency [MHz]	
			1163-1210	1204-1240
Power Gain	$G_p$	dB	30.5	30
Noise Figure	NF	dB	1.0	1.0
Input Return Loss	$RL_{in}$	dB	-20	-20
Output Return Loss	$RL_{out}$	dB	-18	-18
Reverse Isolation	ISO	dB	-40	-40
1 dB Gain Compression	$P_{o(1dB)}$	dBm	11	11
Output Power	OIP3	dBm	17	17
3 <sup>rd</sup> Intercept Point				
Output Power <sup>1)</sup>				
Current	$I_{cc}$	mA	8.5	8.5
Device Voltage	$V_{dd}$	V	3	3

1) OIP3 is measured with two tones at an output power of -10 dBm/tone separated by 1MHz.

### Schematic

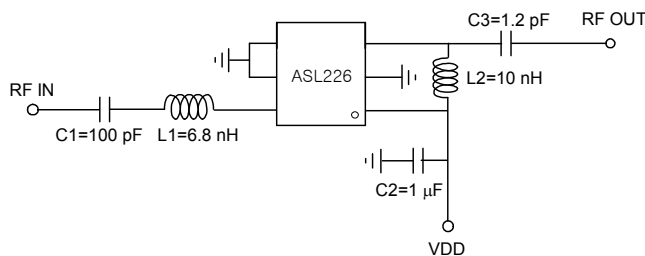

\* Note: Gain and current can be reduced by controlling VDD to 2 V.  
C2 must be placed as close as possible to the device.

### Board Layout (FR4, 14x11.3 mm<sup>2</sup>, 0.8T)

Top

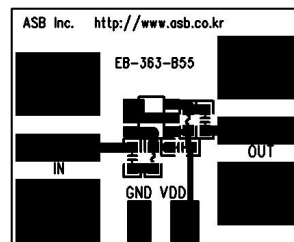

Bottom



### S-parameters & K-factor

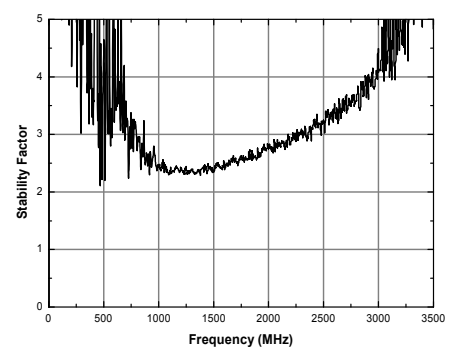
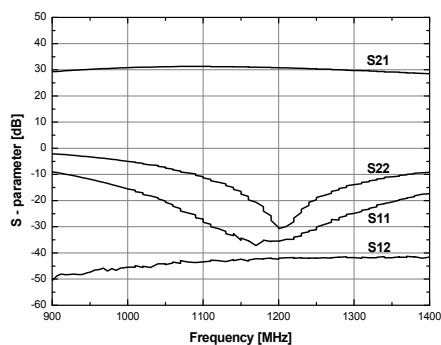

**APPLICATION CIRCUIT**

---

**1558 ~ 1577 MHz**

---

**+3 V**

---

Parameter	Symbol	Unit	Frequency [MHz]
			1558-1577
Power Gain	$G_p$	dB	27.5
Noise Figure	NF	dB	0.95
Input Return Loss	$RL_{in}$	dB	-18
Output Return Loss	$RL_{out}$	dB	-18
Reverse Isolation	ISO	dB	-40
1 dB Gain Compression	$P_{o(1dB)}$	dBm	11
Output Power	OIP3	dBm	16
3 <sup>rd</sup> Intercept Point Output Power <sup>1)</sup>	$I_{cc}$	mA	8.5
Current	$V_{dd}$	V	3
Device Voltage			

1) OIP3 is measured with two tones at an output power of -10 dBm/tone separated by 1MHz.

### Schematic

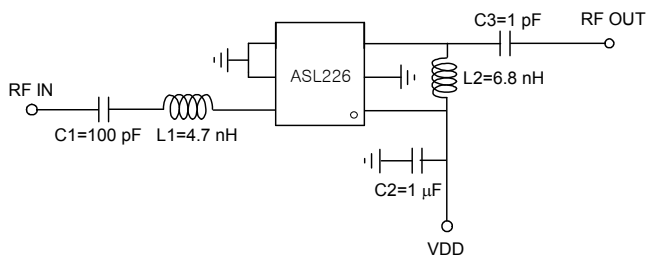

\* Note: Gain and current can be reduced by controlling VDD to 2 V.  
C2 must be placed as close as possible to the device.

### Board Layout (FR4, 14x11.3 mm<sup>2</sup>, 0.8T)

Top

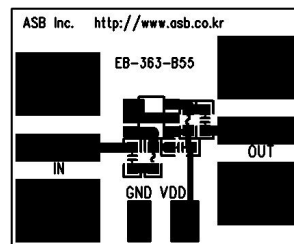

Bottom



### S-parameters & K-factor

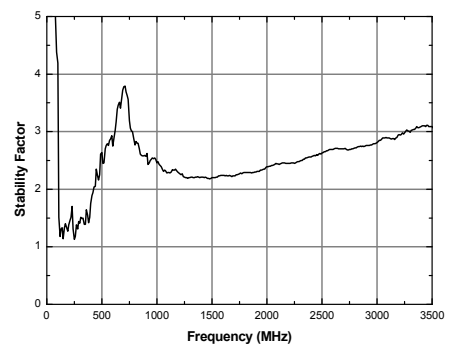
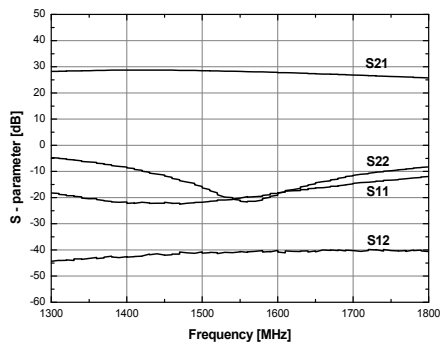

### APPLICATION CIRCUIT

CDMA, GSM

900 MHz

+3 V

Parameter	Symbol	Test Conditions	TYP.		Unit
Power Gain	$G_p$	F = 900 MHz	34	38	dB
Noise Figure	NF	F = 900 MHz	1.3	1.2	dB
Input Return Loss	$RL_{in}$	F = 900 MHz	-14	-10	dB
Output Return Loss	$RL_{out}$	F = 900 MHz	-15	-12	dB
Reverse Isolation	ISO	F = 900 MHz	-40	-45	dB
1 dB Gain Compression Output Power	$P_{o(1dB)}$	F = 900 MHz	9.0	12	dBm
3 <sup>rd</sup> Intercept Point Output Power <sup>1)</sup>	OIP3	F = 900 MHz	18	23	dBm
Current	$I_{cc}$	F = 900 MHz, Non-RF	8.5	18	mA
Device Voltage	$V_{dd}$	F = 900 MHz, Non-RF	3	5	V

1) OIP3 is measured with two tones at an output power of -10 dBm/tone separated by 1MHz.

### Schematic

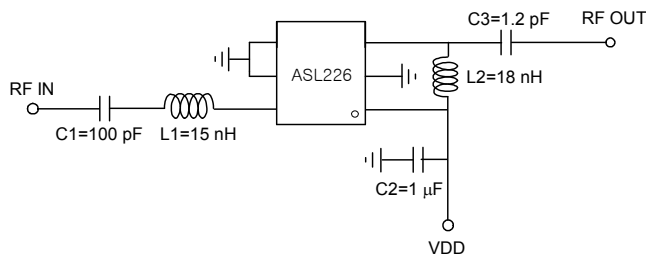

\* Note: Gain and current can be reduced by controlling VDD to 2 V.  
C2 must be placed as close as possible to the device.

### Board Layout (FR4, 14x11.3 mm<sup>2</sup>, 0.8T)

Top

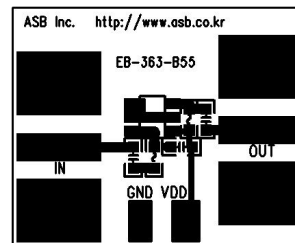

Bottom



### S-parameters & K-factor

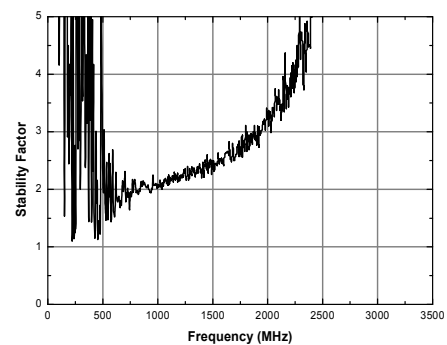
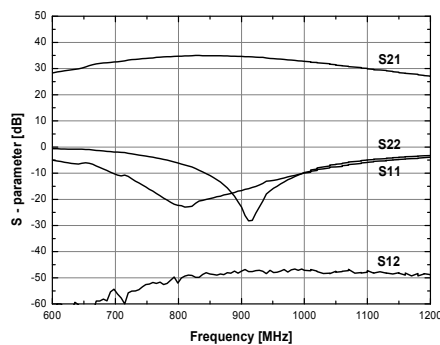

### APPLICATION CIRCUIT

WCDMA

1950 MHz

+3 V / +5 V

Parameter	Symbol	Test Conditions	TYP.		Unit
Power Gain	$G_p$	F = 1950 MHz	25	28	dB
Noise Figure	NF	F = 1950 MHz	1.3	1.05	dB
Input Return Loss	$RL_{in}$	F = 1950 MHz	-15	-18	dB
Output Return Loss	$RL_{out}$	F = 1950 MHz	-20	-12	dB
Reverse Isolation	ISO	F = 1950 MHz	-35	-35	dB
1 dB Gain Compression Output Power	$P_{o(1dB)}$	F = 1950 MHz	10.5	14	dBm
3 <sup>rd</sup> Intercept Point Output Power <sup>1)</sup>	OIP3	F = 1950 MHz	16.5	23	dBm
Current	$I_{cc}$	F = 1950 MHz, Non-RF	8.5	18	mA
Device Voltage	$V_{dd}$	F = 1950 MHz, Non-RF	3	5	V

1) OIP3 is measured with two tones at an output power of -10 dBm/tone separated by 1MHz.

### Schematic

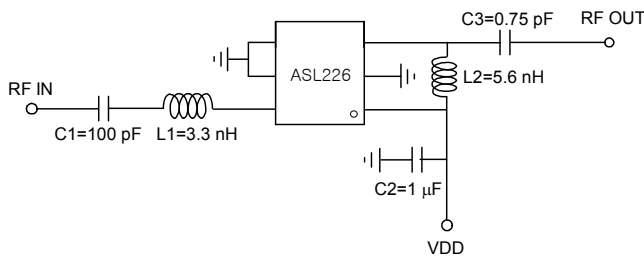

\* Note: Gain and current can be reduced by controlling VDD to 2 V.  
C2 must be placed as close as possible to the device.

### Board Layout (FR4, 14x11.3 mm<sup>2</sup>, 0.8T)

Top

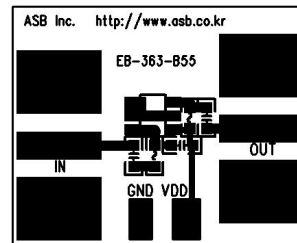

Bottom



### S-parameters & K-factor

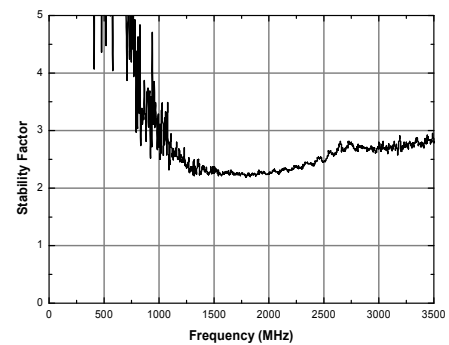
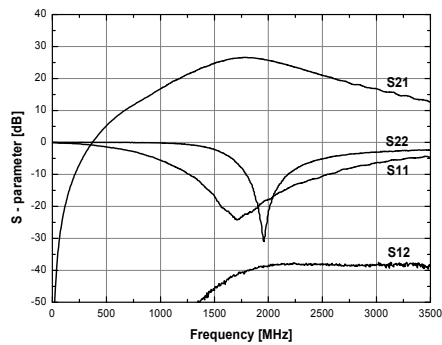

### APPLICATION CIRCUIT

WLAN

2450 MHz

+3 V / +4.2 V

Parameter	Symbol	Test Conditions	TYP.		Unit
Power Gain	$G_p$	F = 2450 MHz	21.5	23.5	dB
Noise Figure	NF	F = 2450 MHz	1.3	1.3	dB
Input Return Loss	$RL_{in}$	F = 2450 MHz	-16	-18	dB
Output Return Loss	$RL_{out}$	F = 2450 MHz	-16	-16	dB
Reverse Isolation	ISO	F = 2450 MHz	-30	-35	dB
1 dB Gain Compression Output Power	$P_{o(1dB)}$	F = 2450 MHz	11	12	dBm
3 <sup>rd</sup> Intercept Point Output Power <sup>1)</sup>	OIP3	F = 2450 MHz	14	18	dBm
Current	$I_{cc}$	F = 2450 MHz, Non-RF	8.5	13	mA
Device Voltage	$V_{dd}$	F = 2450 MHz, Non-RF	3	4.2	V

1) OIP3 is measured with two tones at an output power of -10 dBm/tone separated by 1MHz.

### Schematic

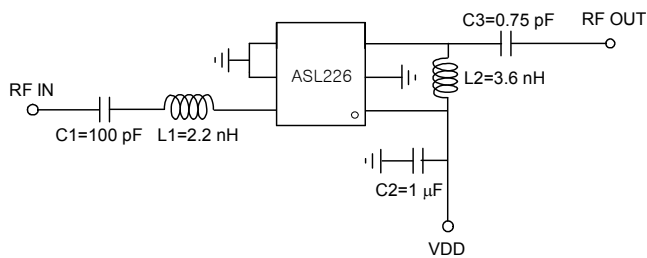

\* Note: Gain and current can be reduced by controlling VDD to 2 V. C2 must be placed as close as possible to the device.

### Board Layout (FR4, 14x11.3 mm<sup>2</sup>, 0.8T)

Top

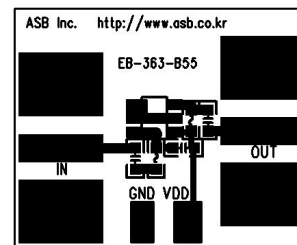

Bottom



### S-parameters & K-factor

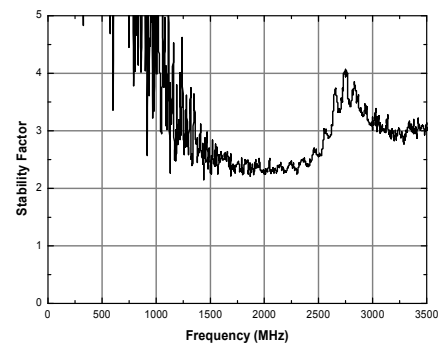
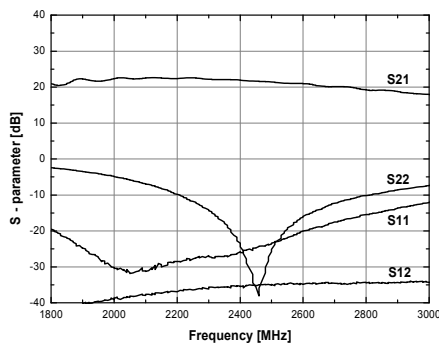



### APPLICATION CIRCUIT

WiMAX

2300 ~ 2900 MHz

+3 V / +4.5 V

Parameter	Symbol	Unit	Frequency [MHz]			
			2300	2900	2300	2700
Power Gain	$G_p$	dB	22.5	19	25	23
Noise Figure	NF	dB	1.3	1.45	1.05	1.15
Input Return Loss	$RL_{in}$	dB	-18	-14	-18	-15
Output Return Loss	$RL_{out}$	dB	-15	-10	-12	-12
Reverse Isolation	ISO	dB	-30	-30	-30	-30
1 dB Gain Compression Output Power	$P_{o(1dB)}$	dBm	11		11	
3 <sup>rd</sup> Intercept Point Output Power <sup>1)</sup>	OIP3	dBm	12.5		20	
Current	$I_{cc}$	mA	8.5		17	
Device Voltage	$V_{dd}$	V	3		4.5	

1) OIP3 is measured with two tones at an output power of -10 dBm/tone separated by 1MHz.

### Schematic

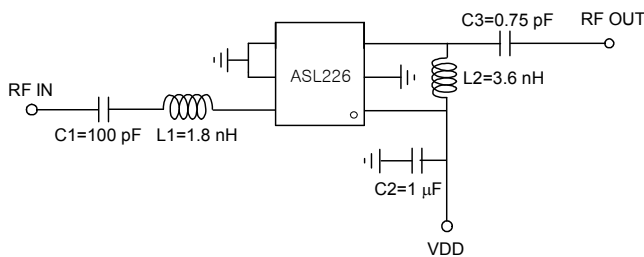

\* Note: Gain and current can be reduced by controlling VDD to 2 V.  
C2 must be placed as close as possible to the device.

### Board Layout (FR4, 14x11.3 mm<sup>2</sup>, 0.8T)

Top

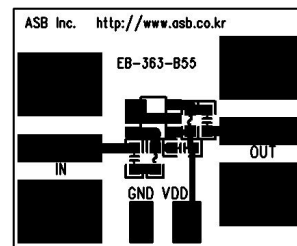

Bottom



### S-parameters & Noise Figure & K-factor (4.5V)

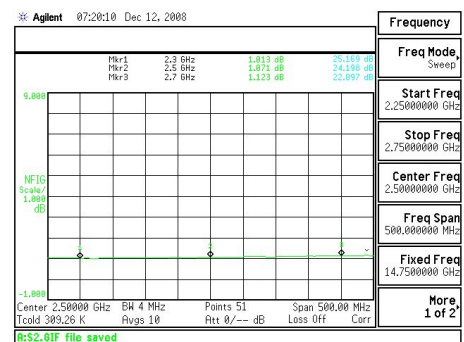
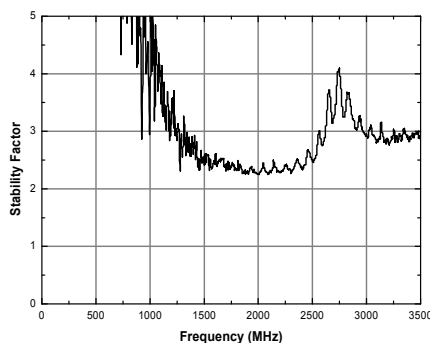
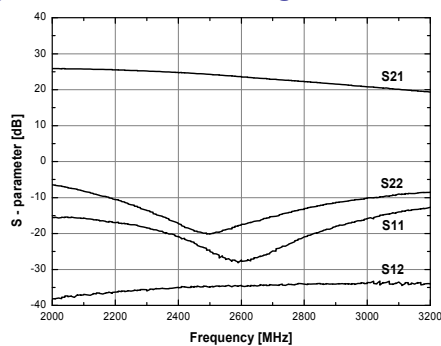

### APPLICATION CIRCUIT

WiMAX

2300 ~ 2900 MHz

+3 V / Low Gain

Parameter	Symbol	Unit	Frequency [MHz]	
			2300	2900
Power Gain	$G_p$	dB	17	15
Noise Figure	NF	dB	1.3	1.45
Input Return Loss	$RL_{in}$	dB	-11	-12
Output Return Loss	$RL_{out}$	dB	-11	-18
Reverse Isolation	ISO	dB	-30	-30
1 dB Gain Compression Output Power	$P_{o(1dB)}$	dBm	5	5.5
3 <sup>rd</sup> Intercept Point Output Power <sup>1)</sup>	OIP3	dBm	8	8
Current	$I_{cc}$	mA	8.5	8.5
Device Voltage	$V_{dd}$	V	3	3

1) OIP3 is measured with two tones at an output power of -10 dBm/tone separated by 1MHz.

### Schematic

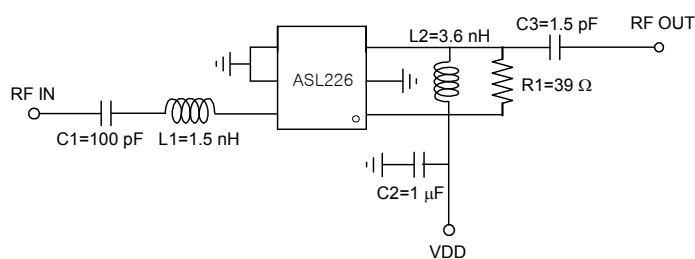

\* Note: Gain and current can be reduced by controlling VDD to 2 V.  
C2 must be placed as close as possible to the device.

### Board Layout (FR4, 14x11.3 mm<sup>2</sup>, 0.8T)

Top

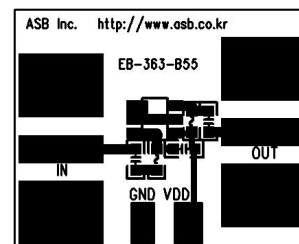

Bottom

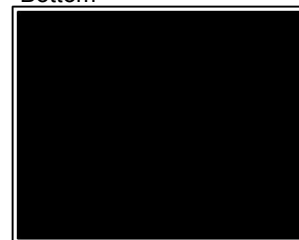

### S-parameters & K-factor

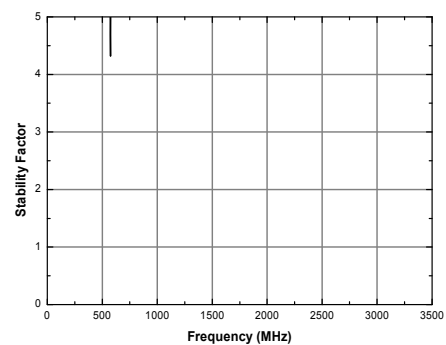
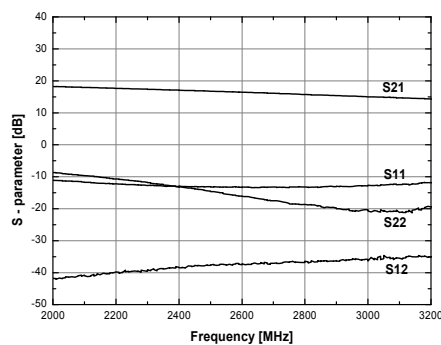

### APPLICATION CIRCUIT

3300 ~ 3800 MHz

+3 V / +5 V

Parameter	Symbol	Unit	Frequency [MHz]			
			3300	3800	3300	3800
Power Gain	$G_p$	dB	16.5	14.5	19	17
Noise Figure	NF	dB	1.55	1.8	1.3	1.5
Input Return Loss	$RL_{in}$	dB	-16	-16	-16	-20
Output Return Loss	$RL_{out}$	dB	-20	-12	-16	-18
Reverse Isolation	ISO	dB	-30	-30	-30	-28
1 dB Gain Compression Output Power	$P_{o(1dB)}$	dBm	9	7.5	10	8
3 <sup>rd</sup> Intercept Point Output Power <sup>1)</sup>	OIP3	dBm	12	9.5	19	16.5
Current	$I_{cc}$	mA	8.5		18	
Device Voltage	$V_{dd}$	V	3		5	

1) OIP3 is measured with two tones at an output power of -10 dBm/tone separated by 1MHz.

### Schematic

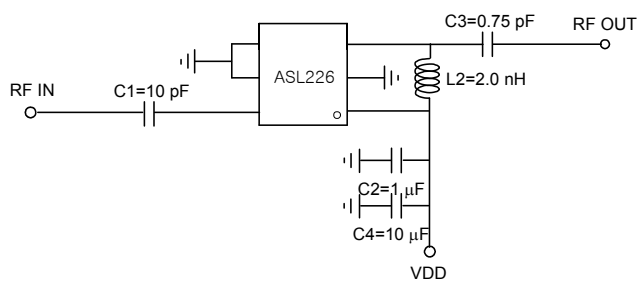

\* Note: Gain and current can be reduced by controlling VDD to 2 V.  
C2 must be placed as close as possible to the device.

### Board Layout (FR4, 14x11.3 mm<sup>2</sup>, 0.8T)

Top

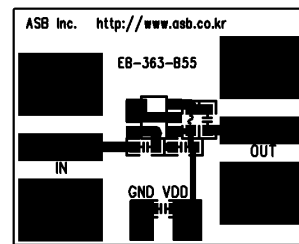

Bottom



### S-parameters & K-factor (3V)

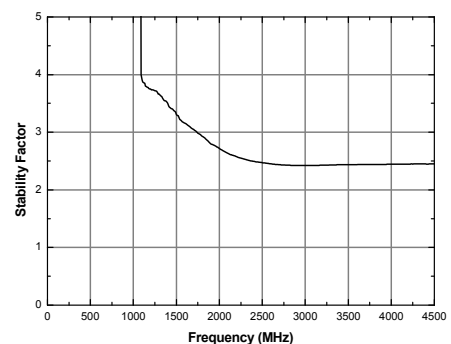
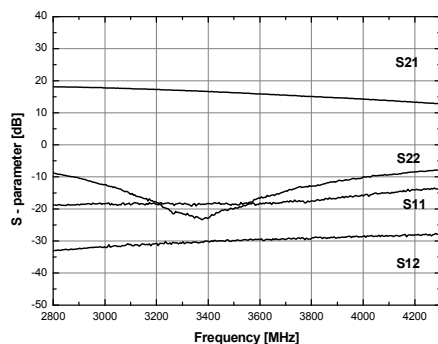

### APPLICATION CIRCUIT

4000 ~ 4500 MHz

+3 V / +5 V

Parameter	Symbol	Unit	Frequency [MHz]			
			4000	4500	4000	4500
Power Gain	$G_p$	dB	12.5	10.5	15	13
Noise Figure	NF	dB	2.0	2.2	1.6	1.8
Input Return Loss	$RL_{in}$	dB	-10	-10	-15	-12
Output Return Loss	$RL_{out}$	dB	-14	-12	-18	-15
Reverse Isolation	ISO	dB	-30	-30	-30	-28
1 dB Gain Compression Output Power	$P_{o(1dB)}$	dBm	7		9	
3 <sup>rd</sup> Intercept Point Output Power <sup>1)</sup>	OIP3	dBm	9.5		17	
Current	$I_{cc}$	mA	8.5		18	
Device Voltage	$V_{dd}$	V	3		5	

1) OIP3 is measured with two tones at an output power of -10 dBm/tone separated by 1MHz.

### Schematic

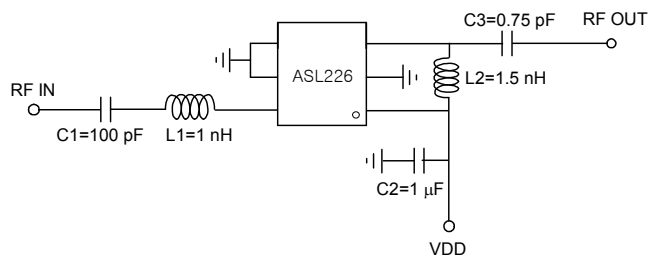

\* Note: Gain and current can be reduced by controlling VDD to 2 V.  
C2 must be placed as close as possible to the device.

### Board Layout (FR4, 14x11.3 mm<sup>2</sup>, 0.8T)

Top

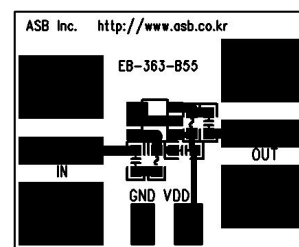

Bottom



### S-parameters & K-factor (5V)

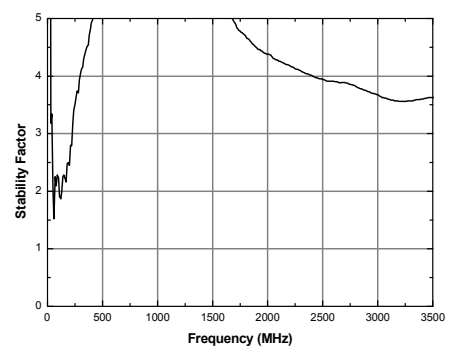
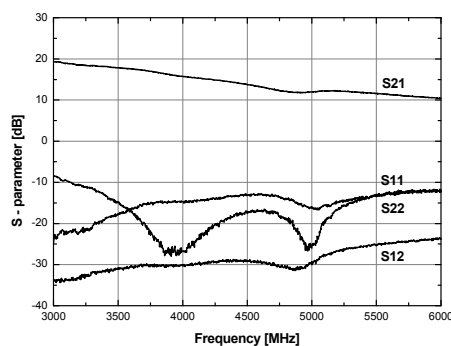

### APPLICATION CIRCUIT

5800 MHz

+3 V

Parameter	Symbol	Test Conditions	MIN.	TYP.	MAX.	Unit
Power Gain	$G_p$	F = 5800 MHz		11.5		dB
Noise Figure	NF	F = 5800 MHz		2.0		dB
Input Return Loss	$RL_{in}$	F = 5800 MHz		-20		dB
Output Return Loss	$RL_{out}$	F = 5800 MHz		-20		dB
Reverse Isolation	ISO	F = 5800 MHz		-25		dB
1 dB Gain Compression Output Power	$P_{o(1dB)}$	F = 5800 MHz		9		dBm
3 <sup>rd</sup> Intercept Point Output Power <sup>1)</sup>	OIP3	F = 5800 MHz		16.5		dBm
Current	$I_{cc}$	F = 5800 MHz, Non-RF		8.5		mA

1) OIP3 is measured with two tones at an output power of -10 dBm/tone separated by 1MHz.

### Schematic

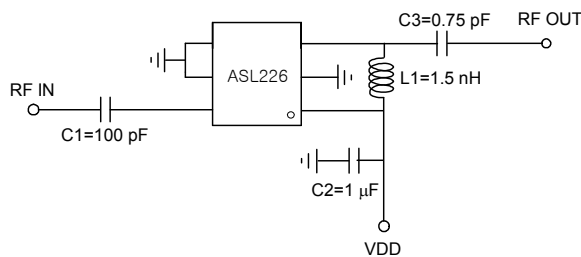

\* Note: Gain and current can be reduced by controlling VDD to 2 V.  
C2 must be placed as close as possible to the device.

### Board Layout (FR4, 14x11.3 mm<sup>2</sup>, 0.8T)

Top

ASB Inc. <http://www.asb.co.kr>

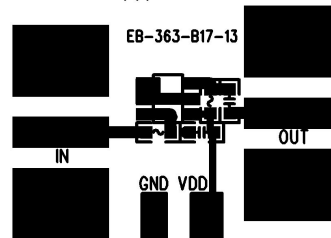

Bottom

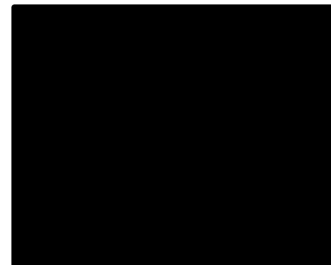

### S-parameters & K-factor

