

SP3012 Series 0.5pF Diode Array

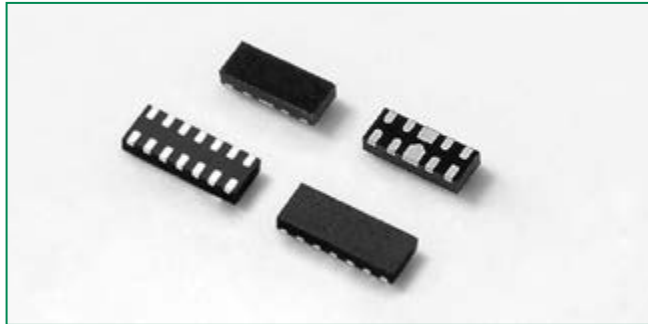

Pinout

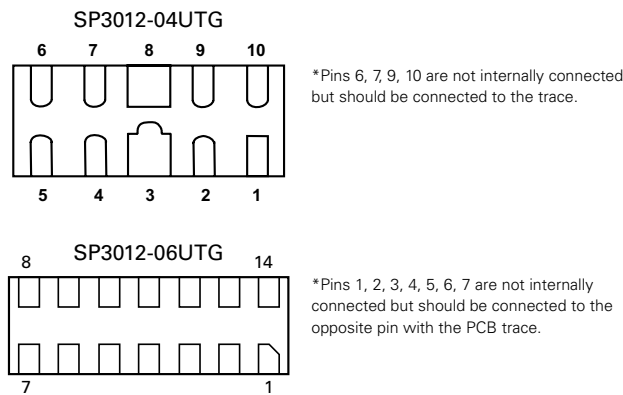

Functional Block Diagram

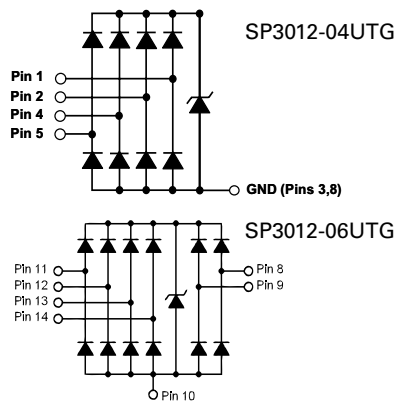

Additional Information



Datashheet



Resources



Samples

Life Support Note:

Not Intended for Use in Life Support or Life Saving Applications

The products shown herein are not designed for use in life sustaining or life saving applications unless otherwise expressly indicated.

Description

The SP3012 integrates either 4 or 6 channels of ultra low capacitance rail-to-rail diodes and an additional zener diode to provide protection for electronic equipment that may experience destructive electrostatic discharges (ESD). These robust devices can safely absorb repetitive ESD strikes above the maximum level specified in the IEC61000-4-2 international standard ($\pm 8\text{kV}$ contact discharge) without performance degradation. The extremely low loading capacitance also makes it ideal for protecting high speed signal lines such as USB3.0, HDMI, USB2.0, and eSATA.

Features

- ESD, IEC61000-4-2, $\pm 12\text{kV}$ contact, $\pm 25\text{kV}$ air
- EFT, IEC61000-4-4, 40A ($t_p=5/50\text{ns}$)
- Lightning, IEC61000-4-5, 4A ($t_p=8/20\mu\text{s}$)
- Low capacitance of 0.5pF (TYP) per I/O
- Low leakage current of $1.5\mu\text{A}$ (MAX) at 5V
- Small form factor μDFN (JEDEC MO-229) package provides flow through routing to simplify PCB layout

Applications

- LCD/PDP TVs
- External Storages
- DVD/Blu-ray Players
- Desktops
- MP3/PMP
- Set Top Boxes
- Smartphones
- Ultrabooks/Notebooks
- Digital Cameras

Application Example for USB3.0

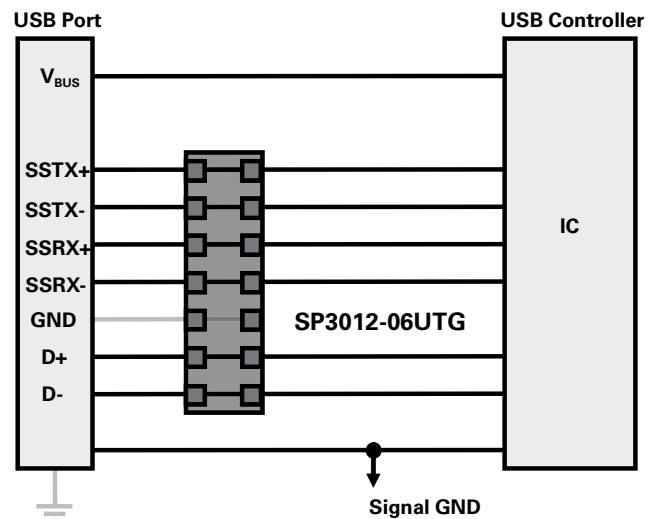

Absolute Maximum Ratings

Symbol	Parameter	Value	Units
I_{PP}	Peak Current ($t_p=8/20\mu s$)	4.0	A
T_{OP}	Operating Temperature	-40 to 125	°C
T_{STOR}	Storage Temperature	-55 to 150	°C

CAUTION: Stresses above those listed in "Absolute Maximum Ratings" may cause permanent damage to the device. This is a stress only rating and operation of the device at these or any other conditions above those indicated in the operational sections of this specification is not implied.

Electrical Characteristics ($T_{OP}=25^\circ C$)

Parameter	Symbol	Test Conditions	Min	Typ	Max	Units
Reverse Standoff Voltage	V_{RWM}	$I_R \leq 1\mu A$			5.0	V
Reverse Leakage Current	I_{LEAK}	$V_R=5V$, Any I/O to GND			1.5	μA
Clamp Voltage ¹	V_C	$I_{PP}=1A$, $t_p=8/20\mu s$, Fwd		6.6		V
		$I_{PP}=2A$, $t_p=8/20\mu s$, Fwd		7.0		V
Dynamic Resistance	R_{DYN}	$(V_{C2} - V_{C1}) / (I_{PP2} - I_{PP1})$		0.4		Ω
ESD Withstand Voltage ¹	V_{ESD}	IEC61000-4-2 (Contact)	± 12			kV
		IEC61000-4-2 (Air)	± 25			kV
Diode Capacitance ¹	$C_{I/O-GND}$	Reverse Bias=0V, f=1 MHz		0.5		pF
Diode Capacitance ¹	$C_{I/O-I/O}$	Reverse Bias=0V, f=1 MHz		0.3		pF

Note: ¹ Parameter is guaranteed by design and/or device characterization.

Capacitance vs. Bias Voltage

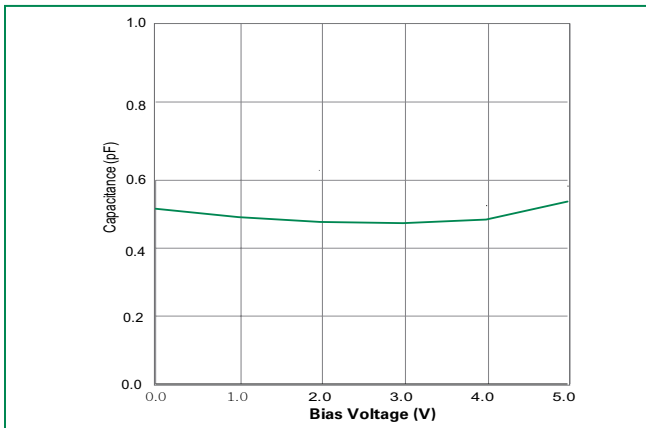

Insertion Loss (S21) I/O to GND

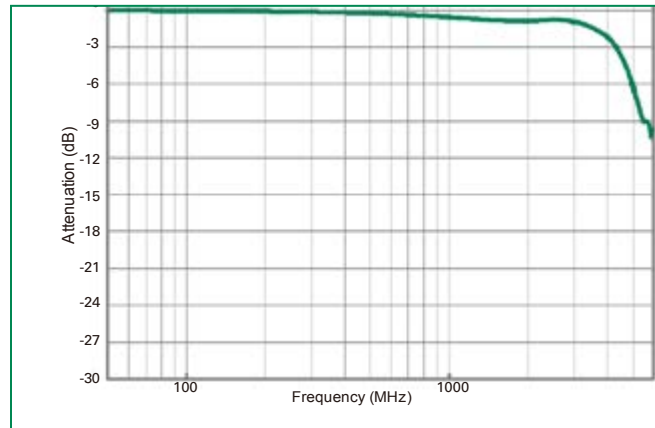

Clamping Voltage vs. I_{PP}

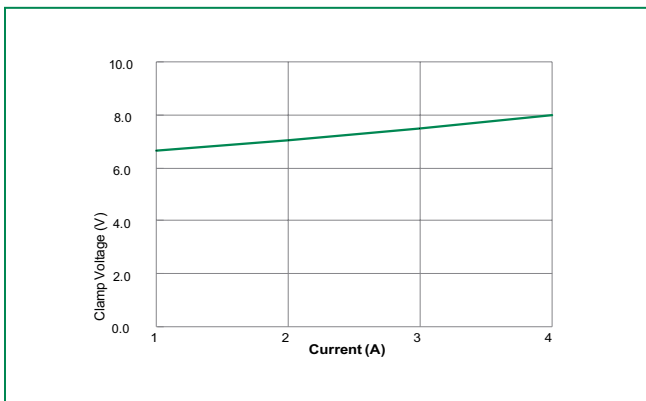

Transmission Line Pulsing (TLP) Plot

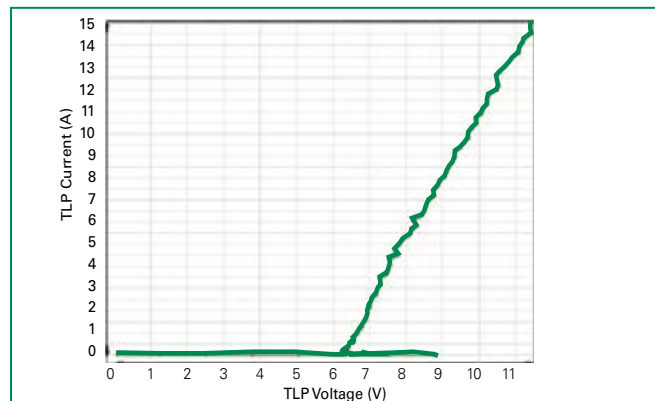

Pulse Waveform

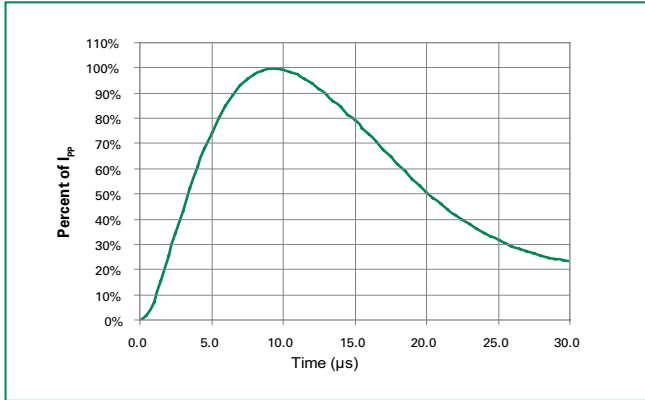

Power Derating Curve

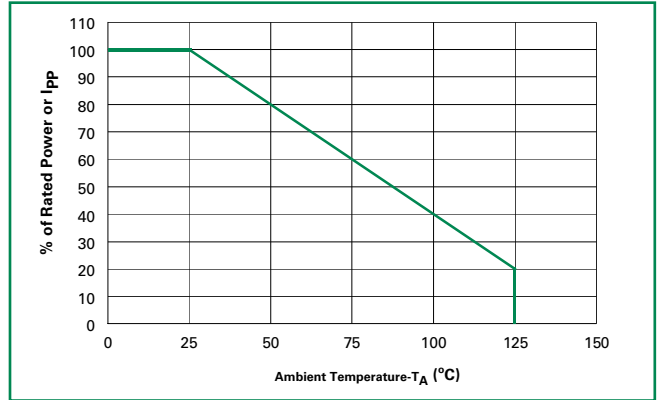

Soldering Parameters

Reflow Condition		Pb – Free assembly
Pre Heat	- Temperature Min ($T_{s(min)}$)	150°C
	- Temperature Max ($T_{s(max)}$)	200°C
	- Time (min to max) (t_s)	60 – 180 secs
Average ramp up rate (Liquidus) Temp (T_L) to peak		3°C/second max
$T_{s(max)}$ to T_L - Ramp-up Rate		3°C/second max
Reflow	- Temperature (T_L) (Liquidus)	217°C
	- Temperature (t_l)	60 – 150 seconds
Peak Temperature (T_p)		260 ^{+0/-5} °C
Time within 5°C of actual peak Temperature (t_p)		20 – 40 seconds
Ramp-down Rate		6°C/second max
Time 25°C to peak Temperature (T_p)		8 minutes Max.
Do not exceed		260°C

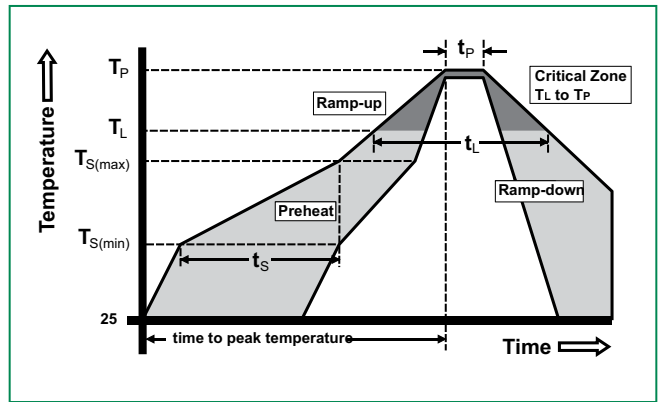

Ordering Information

Part Number	Package	Marking	Min. Order Qty.
SP3012-04UTG	µDFN-10	V*4	3000
SP3012-06UTG	µDFN-14	V*6	3000

Product Characteristics

Lead Plating	Pre-Plated Frame
Lead Material	Copper Alloy
Lead Coplanarity	0.0004 inches (0.102mm)
Substitute Material	Silicon
Body Material	Molded Epoxy
Flammability	UL 94 V-0

Notes :

1. All dimensions are in millimeters
2. Dimensions include solder plating.
3. Dimensions are exclusive of mold flash & metal burr.
4. Blo is facing up for mold and facing down for trim/form, i.e. reverse trim/form.
5. Package surface matte finish VDI 11-13.

Part Numbering System

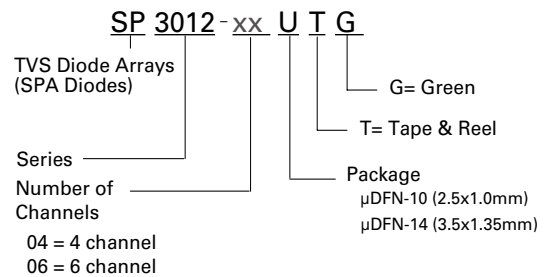

Part Marking System

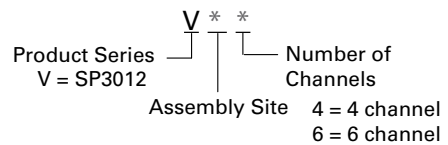

Application Information

Signal Integrity of High-Speed Data Interfaces

Adding external ESD protection to a high-speed data port is not trivial for a variety of reasons.

1. ESD protection devices will add parasitic capacitance to each data line from line to GND and line to line causing impedance mismatches between the differential pairs. This ultimately affects the signal eye-diagram and whether or not the transceiver can distinguish a "1" from a "0".
2. ESD devices should be placed as close as possible to the port being protected to maximize their effect (i.e. clamping capability) and minimize the effect that PCB trace inductance can have during an ESD transient. Depending on the package size and pinout this could be challenging and the bigger the package, the larger the land pattern must be, which adds more parasitic capacitance.
3. Stub traces can add another element of discontinuity adversely affecting signal integrity so ESD protection is best employed when it's "overlaid" on the data lines or when the signals can simply pass underneath the device.

Taking all of this into account Littelfuse developed the SP3012 Series which was designed specifically for protection of high-speed data ports such as HDMI 1.3/1.4 and USB 3.0. They present less than 0.5pF from line to GND and only 0.3pF from line to line minimizing impedance mismatch between the differential pairs.

Furthermore, the SP3012 is rated up to $\pm 12\text{kV}$ (contact discharge) which far exceeds the maximum requirement of the IEC 61000-4-2 standard.

There are two options available (4 channel and 6 channel) and both are housed in leadless μDFN packages so the data lines can pass directly underneath the device to reduce discontinuities and maintain signal integrity.

USB 3.0 Eye Diagram Data

Figure 1 shows the layout used for the SP3012-06UTG in a USB 3.0 application. The traces routed toward the top are the two legacy USB 2.0 lines (D+/D-) that run at the slower speed of 480Mbps and therefore are not as critical as the 5Gbps Super-Speed traces.

Figure 1: PCB Layout of the SP3012-06UTG for USB 3.0

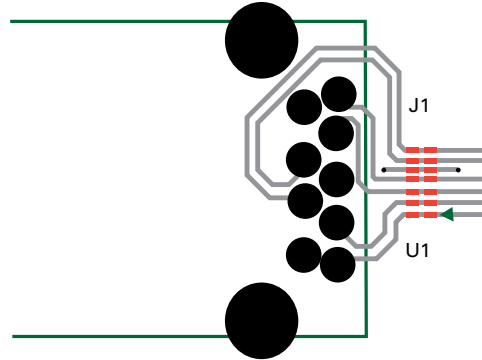

Figure 2 shows the USB 3.0 eye diagram that resulted from the PCB layout above with the SP3012-06UTG soldered on the landing pattern.

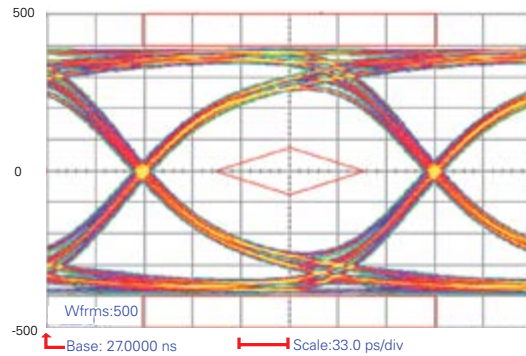

Figure 2: USB 3.0 Eye Diagram with the SP3012-06UTG

Using a similar layout as above, Figure 3 shows the eye diagram that resulted using the SP3012-04UTG to protect the Super-Speed data lines and the SP3003-02UTG to protect the legacy data pair.

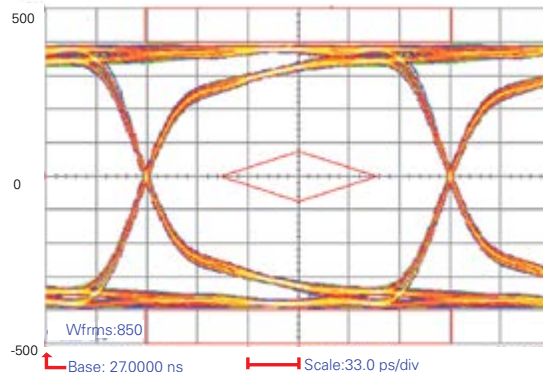
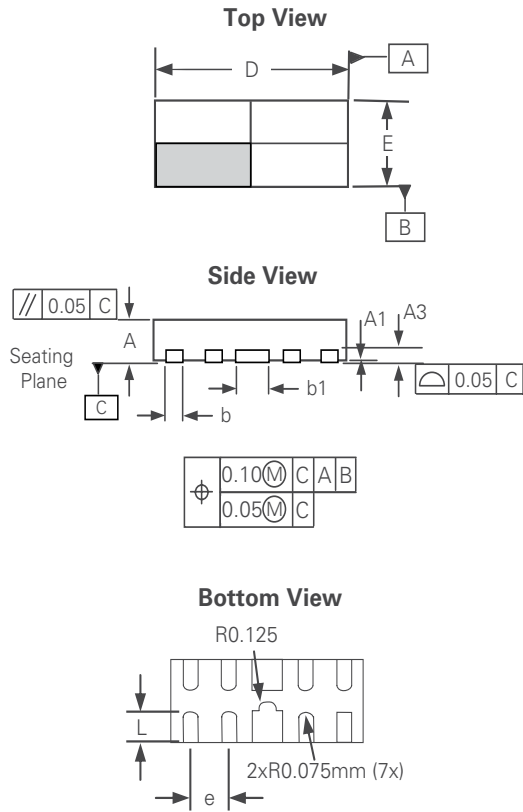

Figure 3: USB 3.0 Eye Diagram with the SP3012-04UTG

Package Dimensions — μ DFN-10 (2.5x1.0x0.5mm)



Package	μ DFN-10 (2.5x1.0x0.5mm)					
JEDEC	MO-229					
Symbol	Millimeters			Inches		
	Min	Nom	Max	Min	Nom	Max
A	0.48	0.515	0.55	0.019	0.020	0.021
A1	0.00	--	0.05	0.000		0.022
A3	0.125 Ref			0.005 Ref		
b	0.15	0.20	0.25	0.006	0.008	0.012
b1	0.35	0.40	0.45	0.014	0.016	0.018
D	2.40	2.50	2.60	0.094	0.098	0.102
E	0.90	1.00	1.10	0.035	0.039	0.043
e	0.50 BSC			0.020 BSC		
L	0.30	0.365	0.43	0.012	0.014	0.016

Soldering Pad Layout Dimensions		
	Inch	Millimeter
C	(0.034)	(0.875)
G	0.008	0.20
P	0.020	0.50
P1	0.039	1.00
X	0.008	0.20
X1	0.016	0.40
Y	0.027	0.675
Y1	(0.061)	(1.55)
Z	0.061	1.55

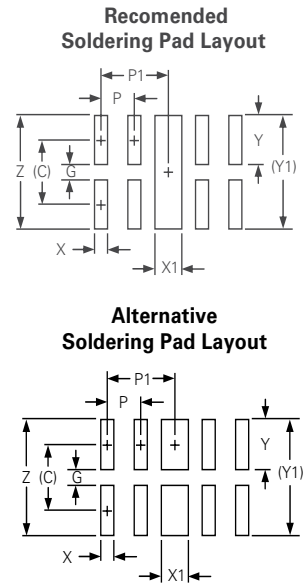

Embossed Carrier Tape & Reel Specification — μ DFN-10

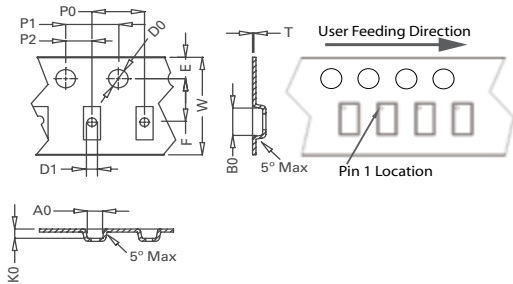

Package	μ DFN-10 (2.5x1.0x0.5mm)
Symbol	Millimeters
A0	1.30 ± 0.10
B0	2.83 ± 0.10
D0	∅ 1.50 ± 0.10
D1	∅ 1.00 ± 0.25
E	1.75 ± 0.10
F	3.50 ± 0.05
K0	0.65 ± 0.10
P0	4.00 ± 0.10
P1	4.00 ± 0.10
P2	2.00 ± 0.05
T	0.254 ± 0.02
W	8.00 + 0.30 / - 0.10

Package Dimensions — μ DFN-14 (3.5x1.35x0.5mm)

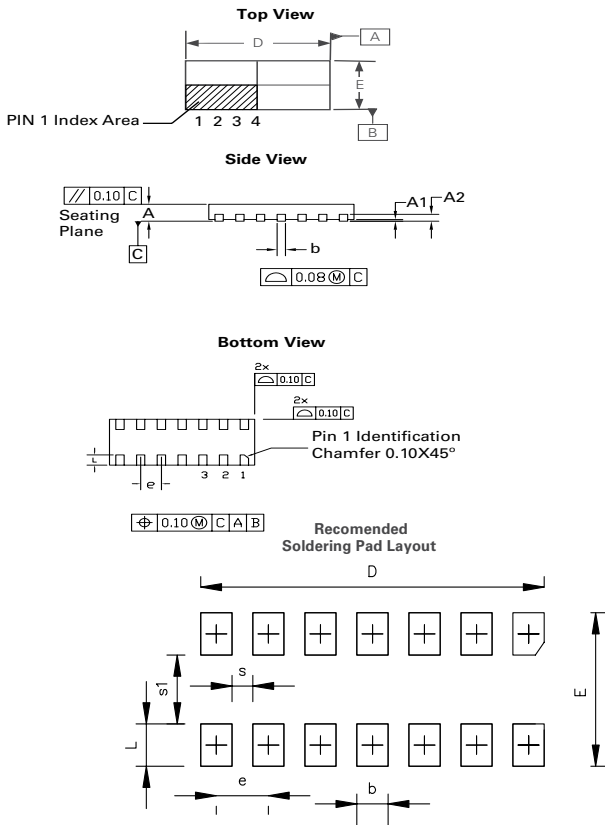

μ DFN-14 (3.5x1.35x0.5mm)						
JEDEC MO-229						
Symbol	Millimeters			Inches		
	Min	Nom	Max	Min	Nom	Max
A	0.45	0.50	0.55	0.018	0.020	0.022
A1	0.00	0.02	0.05	0.000	0.001	0.002
A2	0.203 Ref			0.008 Ref		
b	0.15	0.20	0.25	0.006	0.008	0.012
D	3.40	3.50	3.60	0.134	0.138	0.142
D2	-	-	-	-	-	-
E	1.25	1.35	1.45	0.050	0.054	0.058
E1	-	-	-	-	-	-
e	0.500 BSC			0.020 BSC		
L	0.25	0.30	0.35	0.010	0.012	0.014

Notes:

1. Dimension and tolerancing conform to ASME Y14.5M-1994.
2. Controlling dimensions: Millimeter. Converted Inch dimensions are not necessarily exact.

Soldering Pad Layout Dimensions						
Symbol	Millimeters			Inches		
	Min	Nom	Max	Min	Nom	Max
D	3.29	3.30	3.31	0.1295	0.1299	0.1303
E	1.44	1.45	1.46	0.0567	0.0571	0.0575
b	0.29	0.30	0.31	0.0114	0.0118	0.0122
L	0.39	0.40	0.41	0.0154	0.0158	0.0161
e	0.50 typ			0.020 typ		
s	0.19	0.20	0.21	0.0075	0.0078	0.0083
s1	0.64	0.65	0.66	0.0252	0.0256	0.0260

Embossed Carrier Tape & Reel Specification — μ DFN-14

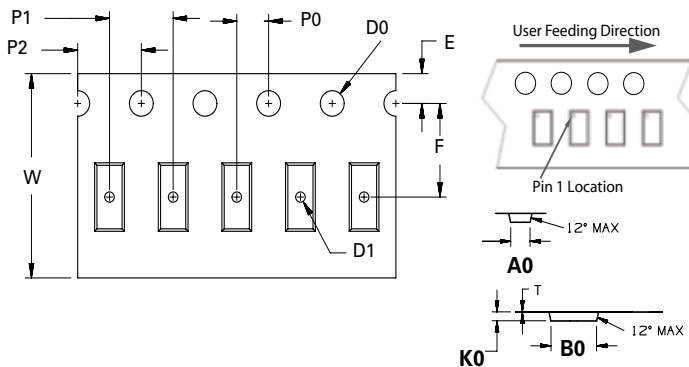

Symbol	Millimeters
A0	1.58 ± 0.10
B0	3.73 ± 0.10
D0	0.60 + 0.05
D1	∅ 0.60 + 0.05
E	1.75 ± 0.10
F	5.50 ± 0.05
K0	0.68 ± 0.10
P0	2.00 ± 0.05
P1	4.00 ± 0.10
P2	4.00 ± 0.10
T	0.28 ± 0.02
W	12.00 + 0.30 /- 0.10