

MGA-22103

2.5-2.7 GHz WiMAX Power Amplifier Module

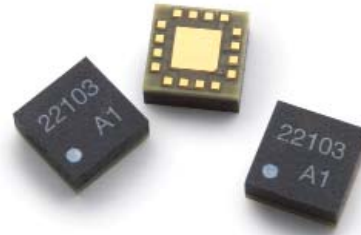

Data Sheet



Description

Avago Technologies MGA-22103 power amplifier module is designed for mobile and fixed wireless data applications in the 2.5 to 2.7 GHz frequency range. The aggressive gain shape limits the noise injected into radio receivers co-located in the same device. The PA is optimized for IEEE 802.16 WiMAX modulation but can be used for any high linearity applications. The PA exhibits flat gain and good match while providing linear power efficiency to meet stringent mask conditions. It utilizes Avago Technologies proprietary GaAs Enhancement-mode pHEMT technology for superior performance across voltage and temperature levels.

The MGA-22103 is packaged in a 3 x 3 x 1 mm package for space-constrained applications.

Functional Block Diagram

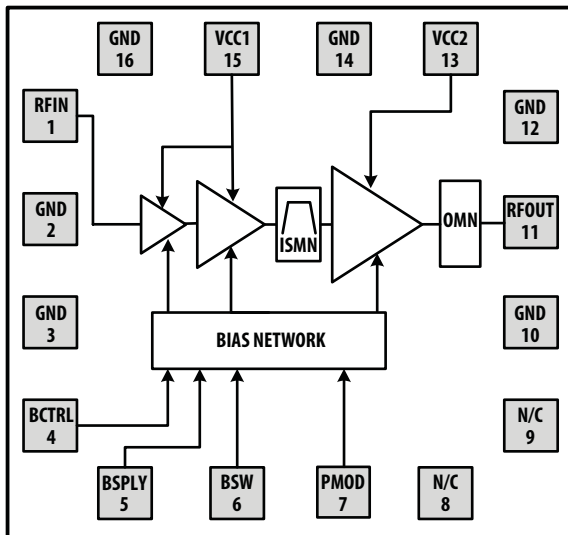

Features

- Advanced GaAs E-pHEMT
- 50 Ω all RF ports
- 25dB gain step in low power mode with reduced I_{dsq}
- Integrated CMOS compatible pins for shutdown and low power mode
- 3 to 5 V supply
- Adjustable bias current with BCTRL pin
- Small size: 3 x 3 x 1 mm
- Stable under all loads or conditions
- -40° C to +85° C operation

At 2.5 GHz (BCTRL = 2.8 V)

- Gain of 34 dB
- PAE of 21% at SEM compliant P_{out} = 25 dBm
- Meets 802.16 masks at 25 dBm P_{out}, 16 QAM WiMAX with 3.3 V and 437 mA
- 16 QAM WiMAX EVM < -32 dB (2.5%) at 25 dBm
- Low power I_{dd}, 85 mA at P_{out} = 0 dBm

Applications

- Portable WiMAX applications with stringent coexistence requirements

Package Diagram

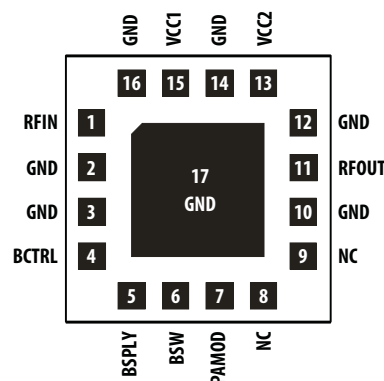

Electrical Specifications

Absolute Minimum and Maximum Ratings

Table 1. Minimum and Maximum Ratings

Parameter		Specifications			
Description	Pin	Min.	Max.	Unit	Comments
Supply Voltage	VCC1 VCC2		5.5	V	
Bias Supply	BSPLY	3	5.5	V	
Bias Control	BCTRL	1.65	5.5	V	
Bias ON/OFF	BSW	1.65	5.5	V	
Mode Control	PAMOD	1.65	5.5	V	
RF Input Power	RFIN		15	dBm	Using 16 QAM ³ / ₄
MSL			MSL3		
Channel Temperature			150	°C	
Storage Temperature		-65	150	°C	

Table 2. Recommended Operating Range

Parameter		Specifications				
Description	Pin	Min.	Typical	Max.	Unit	Comments
Supply Voltage	VCC1 VCC2	3	3.3	5	V	
Bias Supply	BSPLY	3	3.3	5	V	
			13		mA	
Bias Control	BCTRL	2.75	2.8	2.85	V	
			0.7		μA	
Bias ON/OFF	BSW	1.65	1.8	3.3	V	
			7		uA	
Mode Control	PAMOD	1.65	1.8	3.3	V	
			17		μA	
RF Output Power	RFOUT		25	27	dBm	Using 16 QAM ³ / ₄
Frequency Range		2.5		2.7	GHz	
Thermal Resistance, θ_{ch-b}			23.4		°C/W	Channel to board
Case Temperature		-40		+85	°C	

WiMAX (802.16e) Electrical Specifications

All data measured on an FR4 demo board at $V_{cc1} = V_{cc2} = 3.3\text{ V}$, $BCTRL = 2.8\text{ V}$, $T_c = 25^\circ\text{ C}$, $50\ \Omega$ at all ports. Unless otherwise specified, all data is taken with OFDM 16-QAM $\frac{3}{4}$ convolutional coding modulated signal per IEEE 802.16e with 10 MHz BW operating over the BW of 2.5 GHz to 2.7 GHz.

Table 3. RF Electrical Characteristics

Parameter	Performance			Unit	Comments	
	Min.	Typical	Max.			
Input Return Loss		-10		dB		
Gain Flatness		1		dB	Over any 10 MHz	
Gain Variation (V_{CC})	-1		1	dB	3 V to 5 V	
High Power Mode	EVM		-34	-30	dB	$V_{cc} = 3.3\text{ V}$
			-36	-32		$V_{cc} = 3.6\text{ V}$
	SEM-A @ 5.05 MHz		-20	-13	dBm/100 kHz	IBW = 100 kHz
	SEM-B @ 6.5 MHz		-20	-13	dBm/MHz	IBW = 1 MHz
	SEM-C @ 10.5 MHz		-26	-19		
	SEM-D @ 11.5 MHz		-27	-25		
	SEM-E @ 15.5 MHz		-37	-29.5		
	SEM-F @ 20.5 MHz		-40	-37		
	Pout (SEM Compliant)	+25			dBm	802.16e
Total DC Current		437		mA	Pout = 25 dBm	
Gain	31	34	37	dB		
Low Power Mode	EVM		-36		dB	Pout = 0 dBm
	Gain Step	18	23	24	dB	
	Total DC Current		85		mA	Pout = 0 dBm
P1dB		31		dBm	CW Single Tone	
Psat		32		dBm	CW Single Tone	
2fo		-36		dBm/MHz		
Settling Time	0.2	0.5		μS		
Icc leakage current		10	40	μA	Max current specified at 85° C	
Noise Power in Cell Band		-146		dBm/Hz		
Noise Power in GPS Band		-149		dBm/Hz		
Noise Power in PCS		-144		dBm/Hz		

Selected performance plots

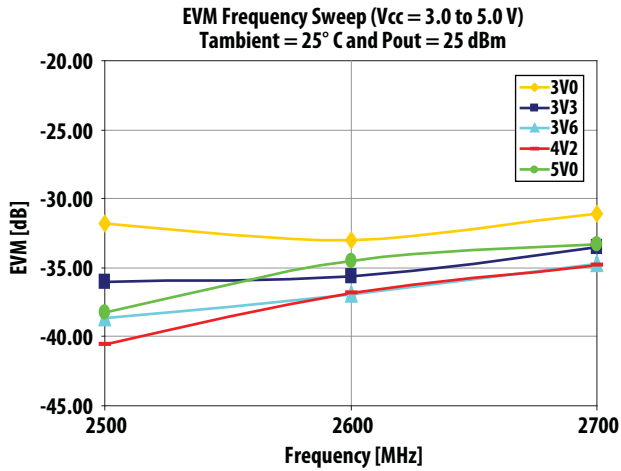

Figure 1. EVM Frequency Sweep at 25° C and Pout = 25 dBm over Vcc

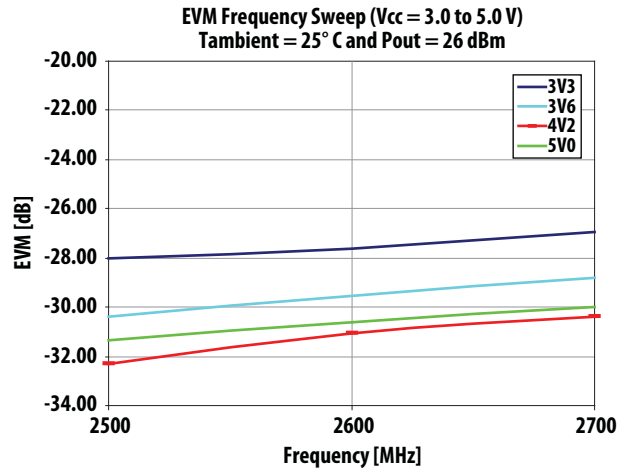

Figure 2. EVM Frequency Sweep at 25° C and Pout = 26 dBm over Vcc

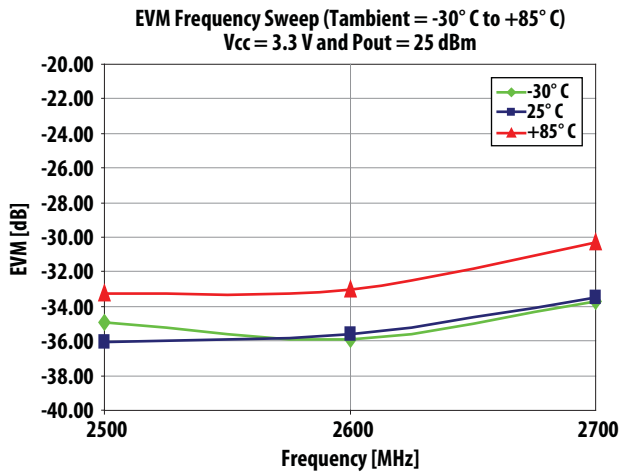

Figure 3. EVM Frequency Sweep at Vcc = 3.3 V and Pout = 25 dBm over Tambient

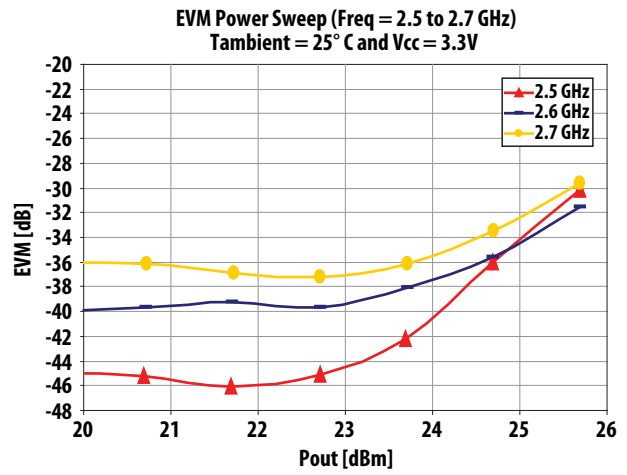

Figure 4. EVM Power Sweep at Vcc = 3.3 V and 25° C over Frequency

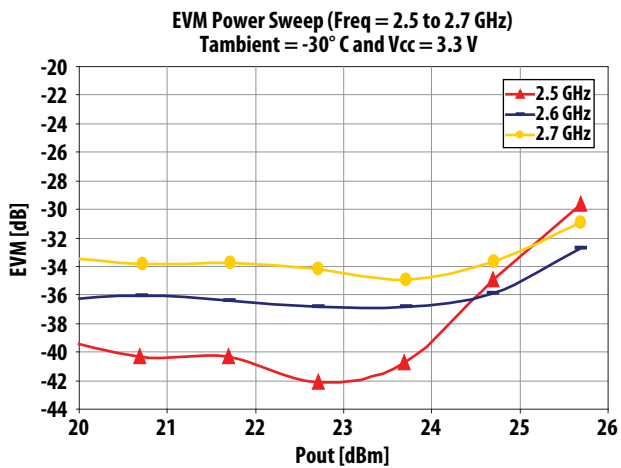

Figure 5. EVM Power Sweep at Vcc = 3.3 V and -30° C over Frequency

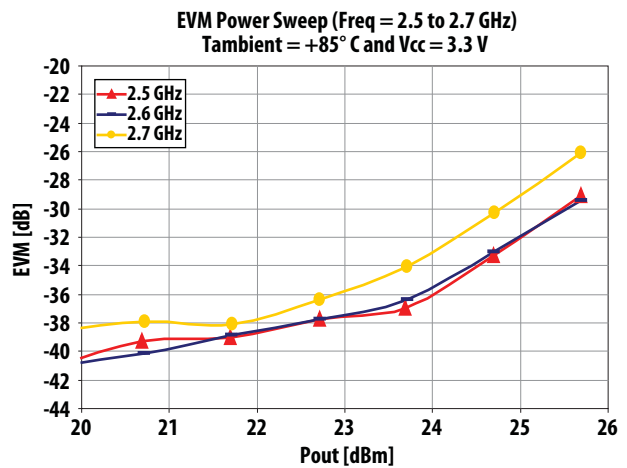

Figure 6. EVM Power Sweep at Vcc = 3.3 V and +85° C over Frequency

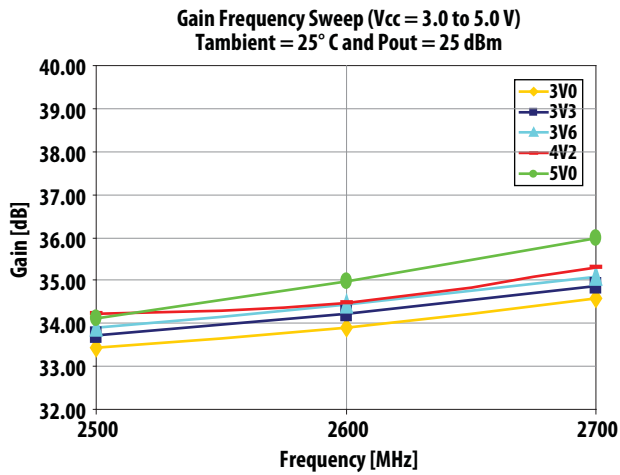

Figure 7. Gain Frequency Sweep at 25°C and Pout = 25 dBm over Vcc

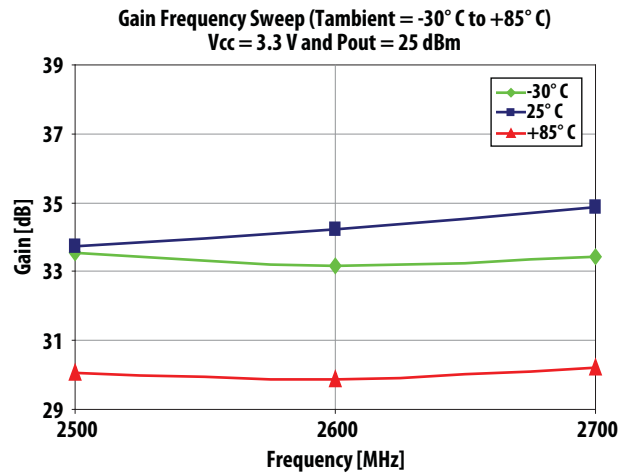

Figure 8. Gain Frequency Sweep at Vcc = 3.3 V and Pout = 25 dBm over Tambient

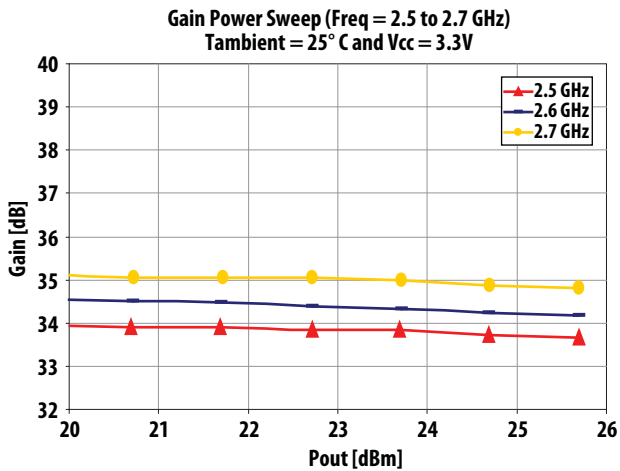

Figure 9. Gain Power Sweep at Vcc = 3.3 V and 25°C over Pout

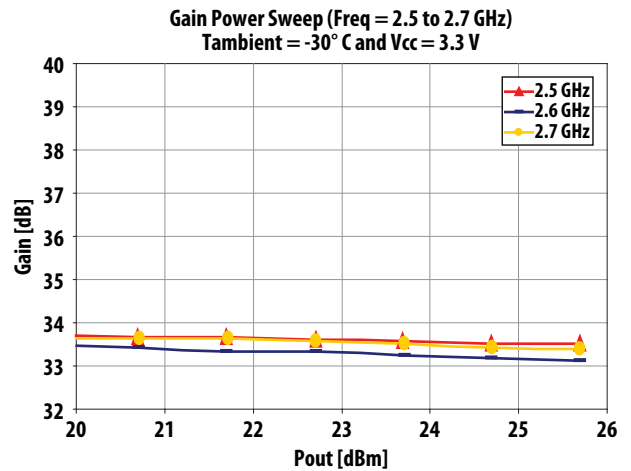

Figure 10. Gain Power Sweep at Vcc = 3.3 V and -30°C over Pout

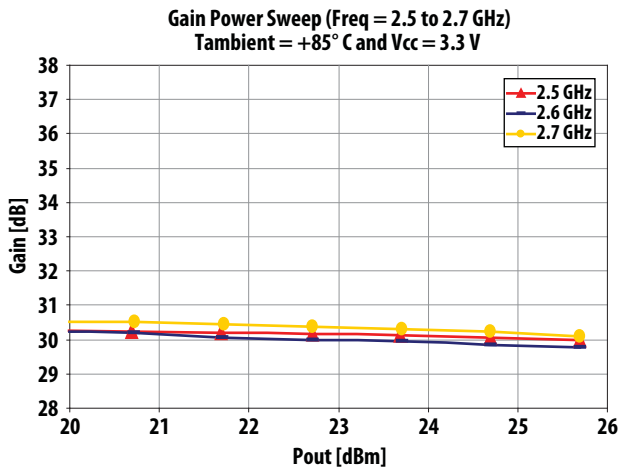

Figure 11. Gain Power Sweep at Vcc = 3.3 V and +85°C over Pout

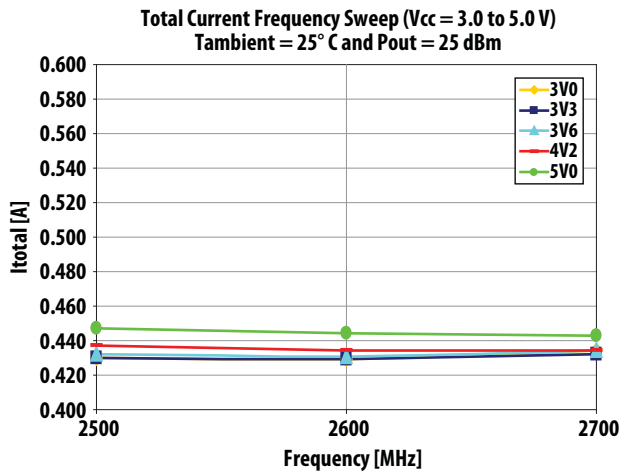

Figure 12. Total Current Frequency Sweep at 25° C and Pout = 25 dBm over Vcc

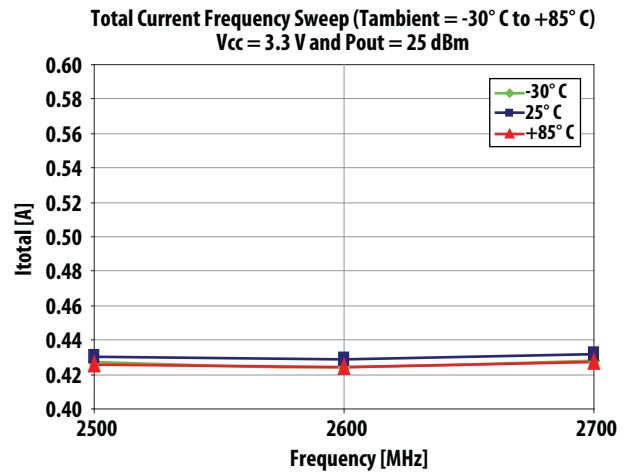

Figure 13. Total Current Frequency Sweep at 3.3 V and Pout = 25 dBm over Tambient

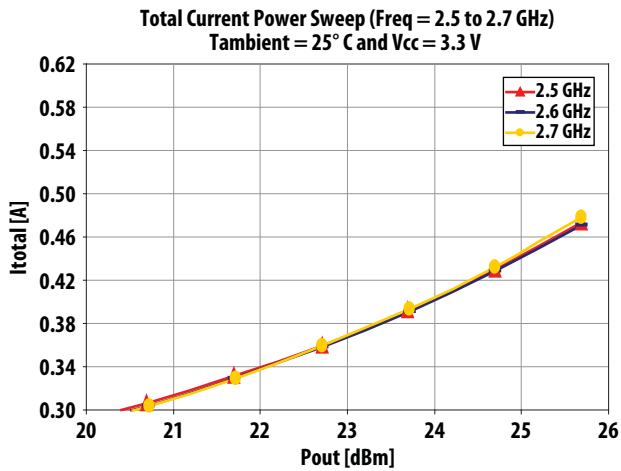

Figure 14. Total Current Power Sweep at 3.3 V and 25° C over Frequency

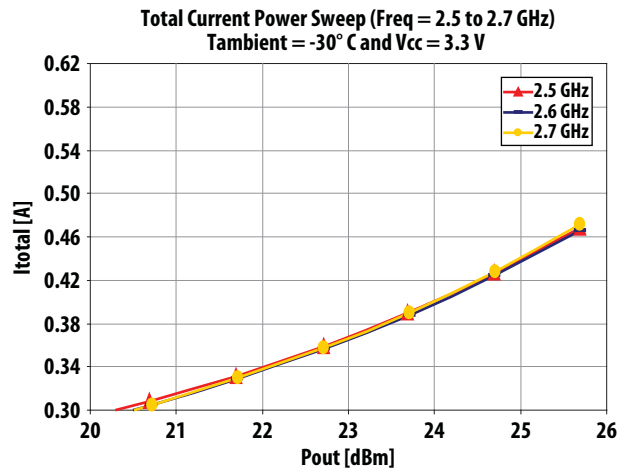

Figure 15. Total Current Power Sweep at 3.3 V and -30° C over Frequency

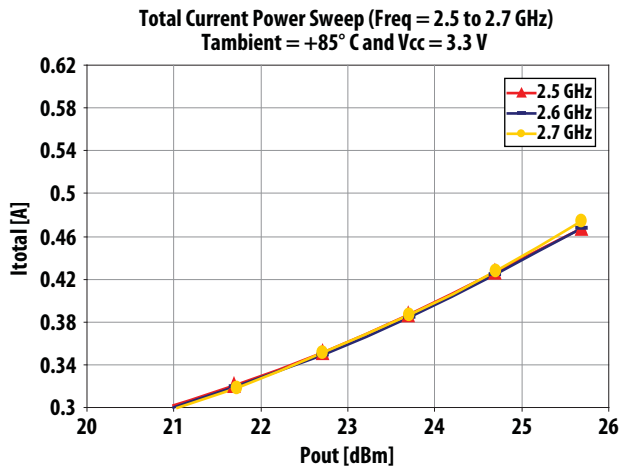

Figure 16. Total Current Power Sweep at 3.3 V and +85° C over Frequency

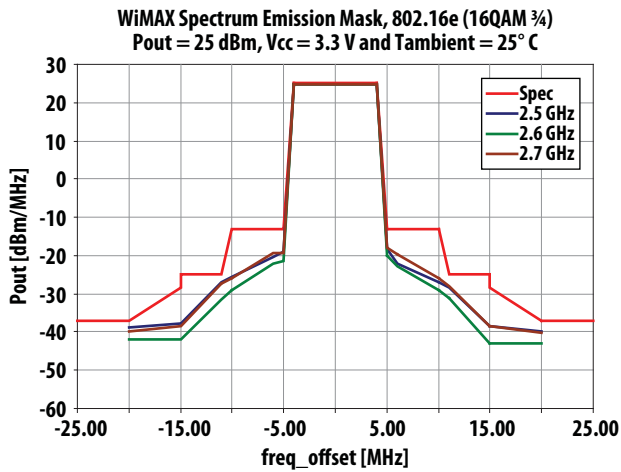

Figure 17. SEM Frequency Sweep at Vcc = 3.3 V and 25°C (2 dB Post-PA loss assumed)

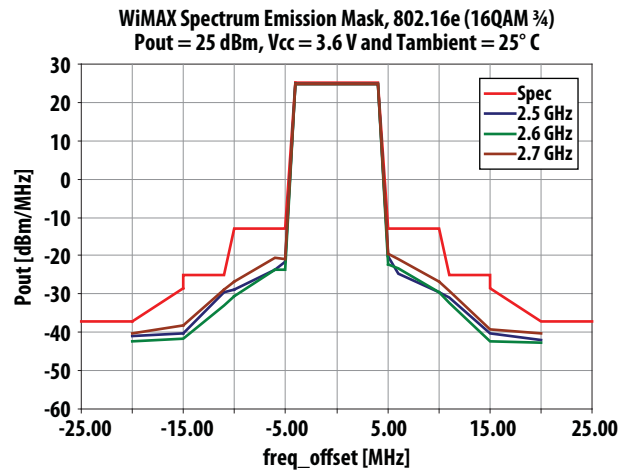

Figure 18. SEM Frequency Sweep at Vcc = 3.6 V and 25°C (2dB Post-PA loss assumed)

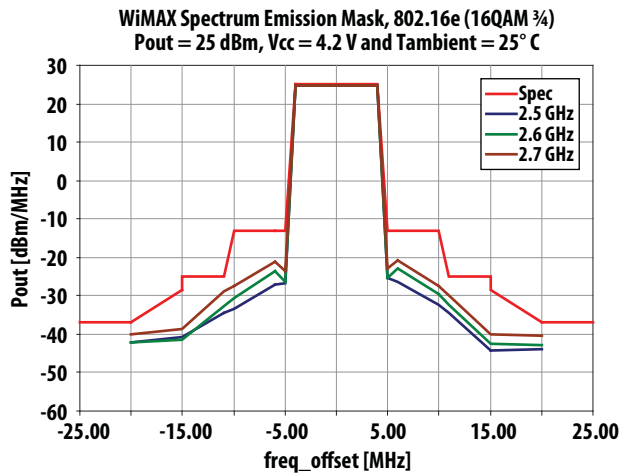

Figure 19. SEM Frequency Sweep at Vcc = 4.2 V and 25°C (2 dB Post-PA loss assumed)

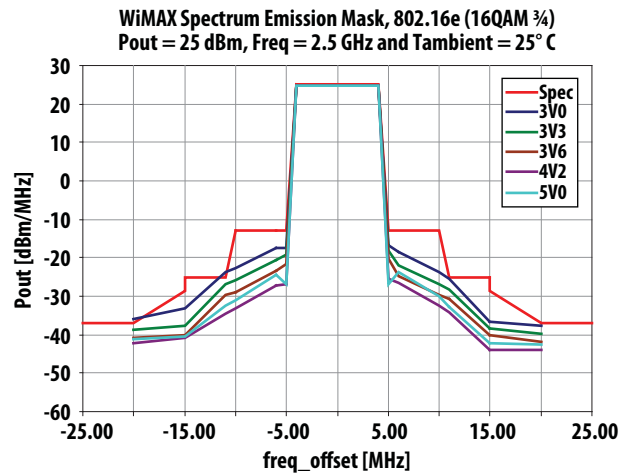

Figure 20. SEM at Vcc = 3.3 V, 25°C and 2.5 GHz over Vcc (2dB Post-PA loss assumed)

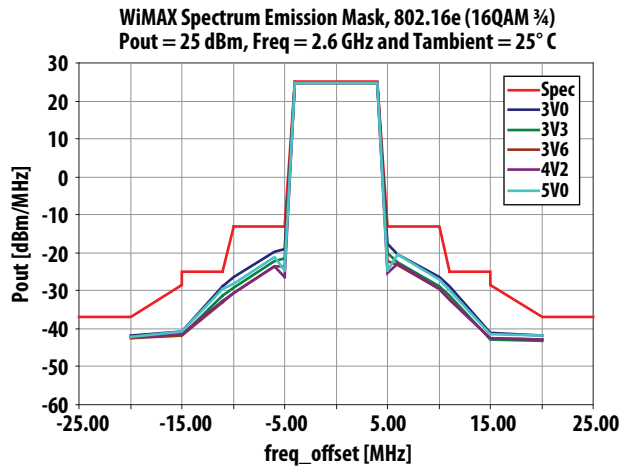

Figure 21. SEM at Vcc = 3.3 V, 25°C and 2.6 GHz over Vcc (2 dB Post-PA loss assumed)

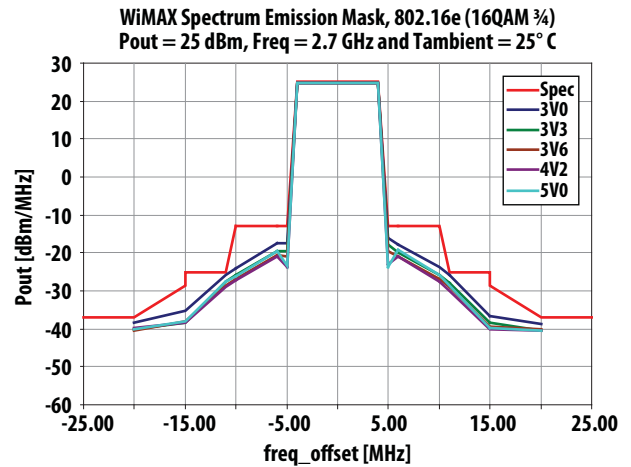

Figure 22. SEM at Vcc = 3.3 V, 25°C and 2.7 GHz over Vcc (2dB Post-PA loss assumed)

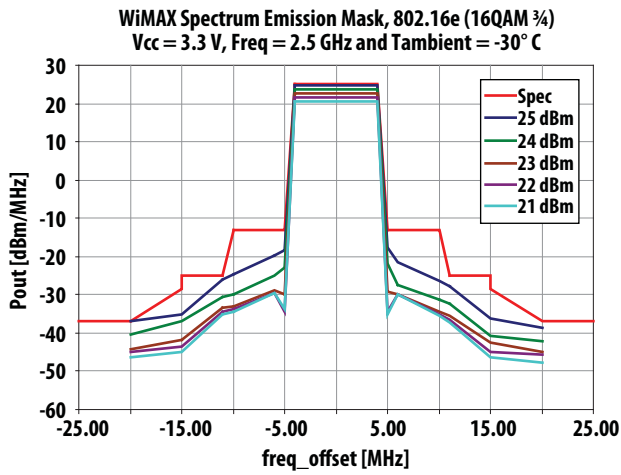

Figure 23. SEM at Vcc = 3.3 V, -30° C and 2.5 GHz over Vcc (2 dB Post-PA loss assumed)

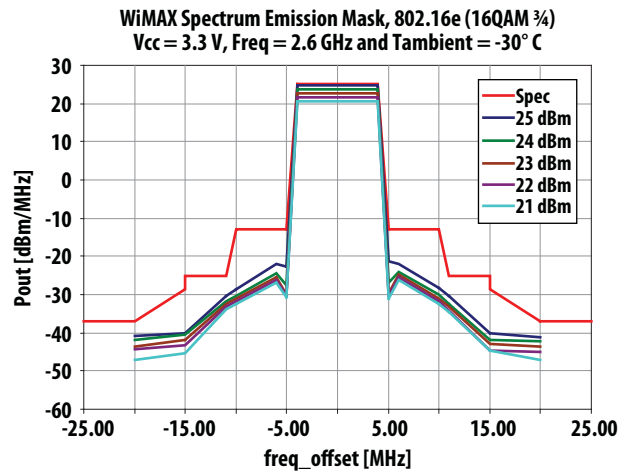

Figure 24. SEM at Vcc = 3.3 V, -30° C and 2.6 GHz over Vcc (2 dB Post-PA loss assumed)

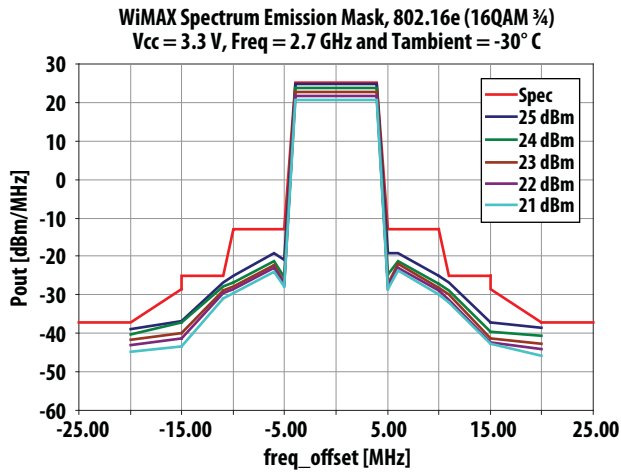

Figure 25. SEM at Vcc = 3.3 V, -30° C and 2.7 GHz over Vcc (2 dB Post-PA loss assumed)

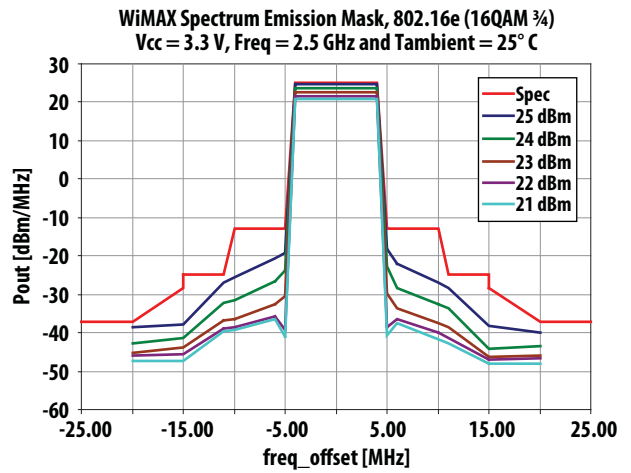

Figure 26. SEM at Vcc = 3.3 V, 25° C and 2.5 GHz over Vcc (2 dB Post-PA loss assumed)

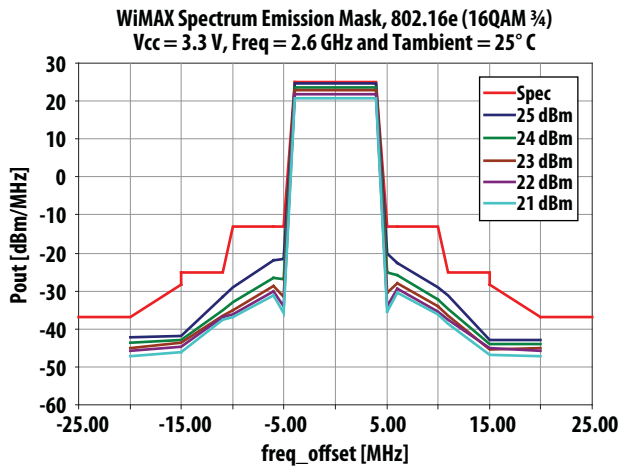

Figure 27. SEM at Vcc = 3.3 V, 25° C and 2.6 GHz over Vcc (2 dB Post-PA loss assumed)

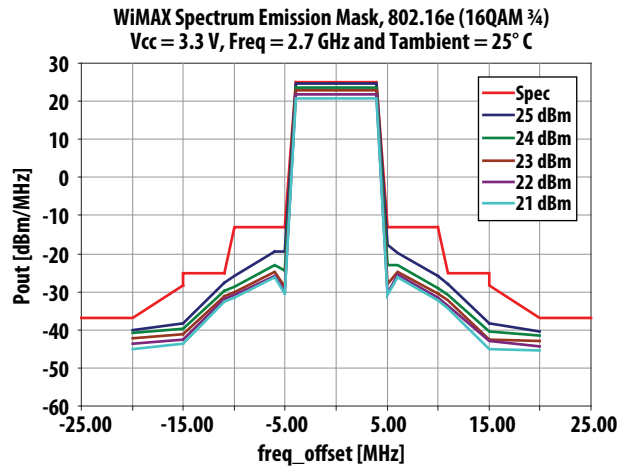

Figure 28. SEM at Vcc = 3.3 V, 25° C and 2.7 GHz over Vcc (2 dB Post-PA loss assumed)

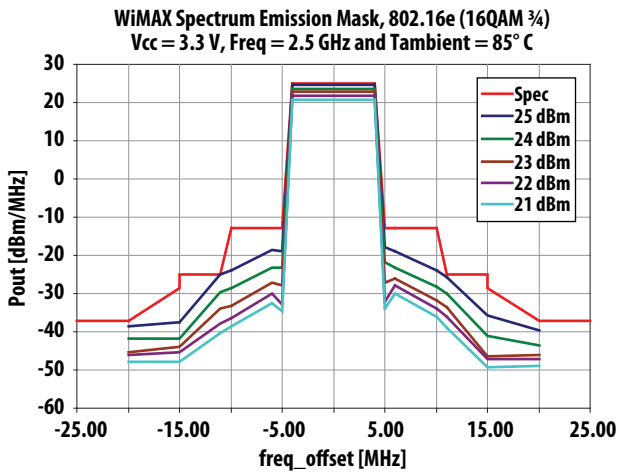

Figure 29. SEM at Vcc = 3.3 V, +85° C and 2.5 GHz over Vcc (2 dB Post-PA loss assumed)

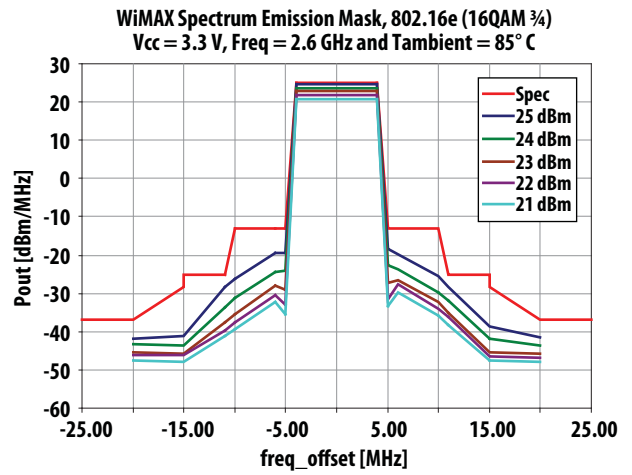

Figure 30. SEM at Vcc = 3.3 V, +85° C and 2.6 GHz over Vcc (2 dB Post-PA loss assumed)

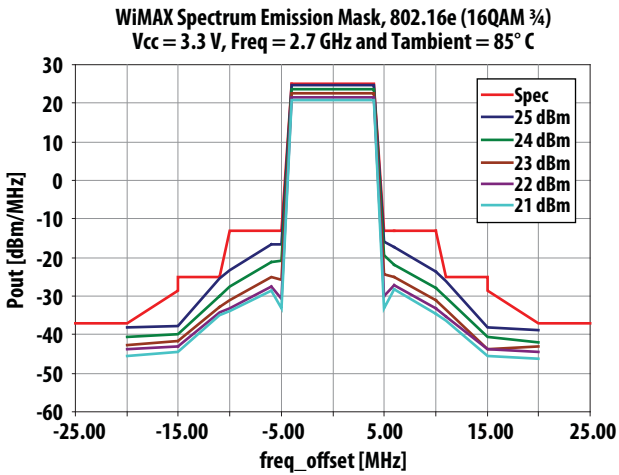

Figure 31. SEM at Vcc = 3.3 V, +85° C and 2.7 GHz over Vcc (2 dB Post-PA loss assumed)

Evaluation Board Description

Table 4. Pin Description:

Top Pin No.	Function	Bottom Pin No.	Function
1	VCC2	2	VCC2
3	B_SPLY	4	GND
5	VCC1	6	GND
7	NC	8	GND
9	PAMOD	10	GND
11	NC	12	GND
13	NC	14	B_SW
15	B_CTRL	16	GND
17	NC	18	GND
19	NC	20	GND

Recommended turn on sequence

- Apply VCC1 and VCC2
- Apply BSPLY
- Apply BCTRL
- Apply BSW
- For HPM Apply PAMOD HI
- For LPM Apply PAMOD LO
- Apply RF Input not to exceed 15 dBm

Turn off in reverse order

Table 5. Typical Test Conditions:

Pin	HPM	LPM	
VCC1, 2	3.3 V	3.3 V	Supply Voltage
PAMOD	1.8 V	0 V	Low Power Mode
B_SPLY	3.3 V	3.3 V	Bias Voltage
B_CTRL	2.8 V	2.8 V	Bias Control
B_SW	1.8 V	1.8 V	PA Enable

Notes: VCC1, VCC2 and B_SPLY can be tied together to reduce supply voltages, but B_CTRL needs to be a regulated voltage which is optimized for 2.8 V at Vcc of 3.3 V. Other bias points are described under flexible BCTRL optimization section.

Demoboard Top Pins

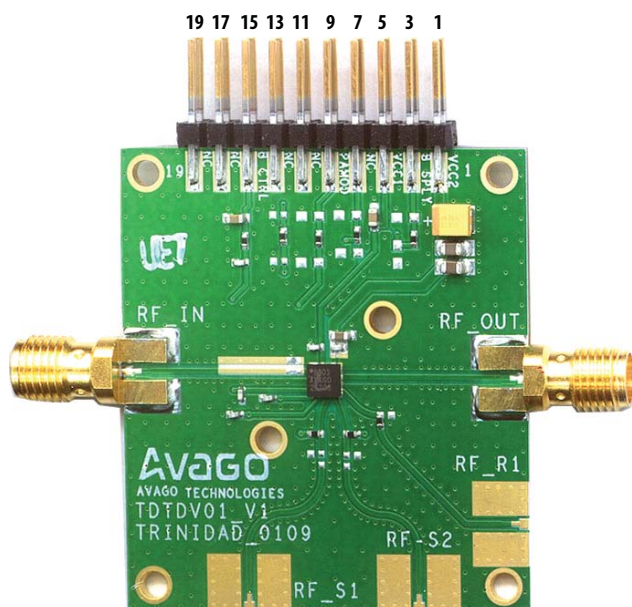

Demoboard Bottom Pins



Application Circuit MGA-22103

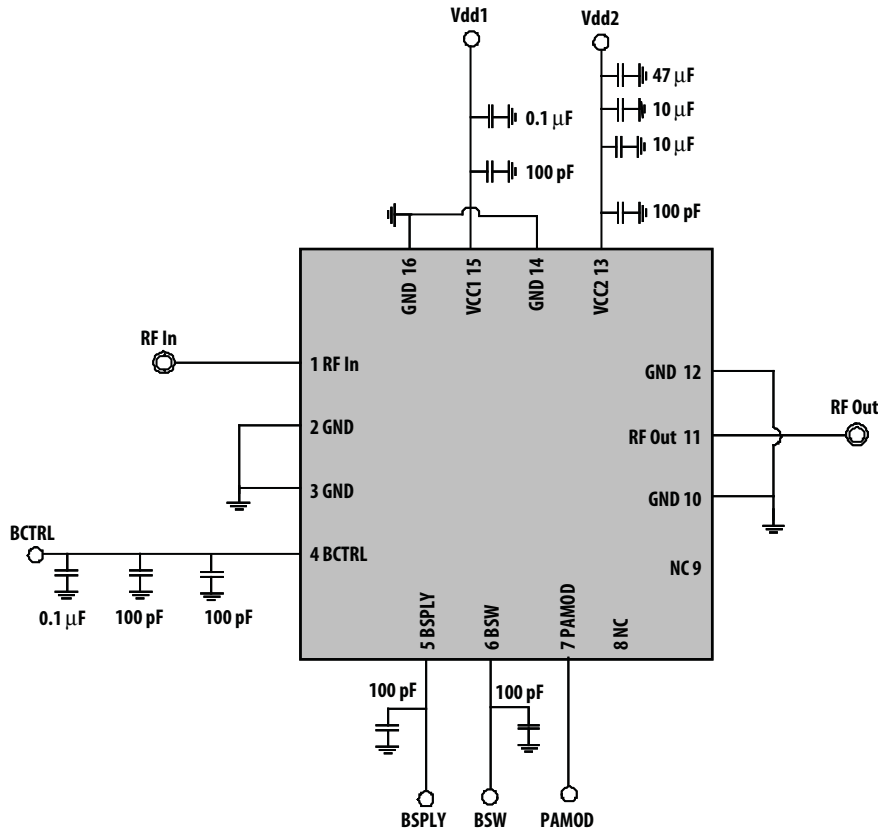

Using 3.3 V or 5 V Supply and connecting Vcc1, Vcc2, BSLPY and BCTRL

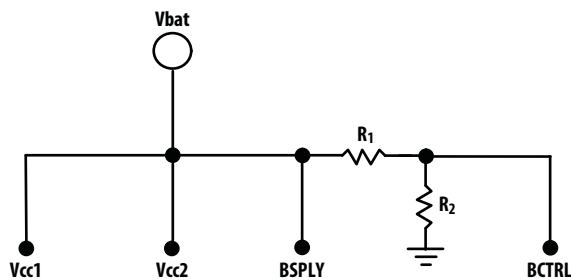

Notes:

BCTRL regulates the device current, thus R1 and R2 should have good tolerance rating. If available, a voltage regulator is the preferred method of bias.

In this example we set R2 at 10 MOhm and solve for R1 with simple voltage divider equation. Use high resistance values to limit leakage current.

3.3 V Example:

$$V_{BCTRL} = \frac{R_2}{R_1 + R_2} * V_{BATT}$$

$$2.85 \text{ V} = \frac{10 \text{ M}\Omega}{R_1 + 10 \text{ M}\Omega} * 3.3 \text{ V}$$

$$R_1 = 1.58 \text{ M}\Omega$$

$$R_2 = 10 \text{ M}\Omega$$

Given:

$$V_{BCTRL} = 2.85 \text{ V}$$

$$V_{BAT} = 3.3 \text{ V}$$

$$R_2 = 10 \text{ M}$$

$$R_1 = ?$$

5.0 V Example:

$$V_{BCTRL} = \frac{R_2}{R_1 + R_2} * V_{BATT}$$

$$2.85 \text{ V} = \frac{10 \text{ M}\Omega}{R_1 + 10 \text{ M}\Omega} * 5.0 \text{ V}$$

$$R_1 = 7.54 \text{ M}\Omega$$

$$R_2 = 10 \text{ M}\Omega$$

Given:

$$V_{BCTRL} = 2.85 \text{ V}$$

$$V_{BAT} = 5.0 \text{ V}$$

$$R_2 = 10 \text{ M}$$

$$R_1 = ?$$

Land Pattern

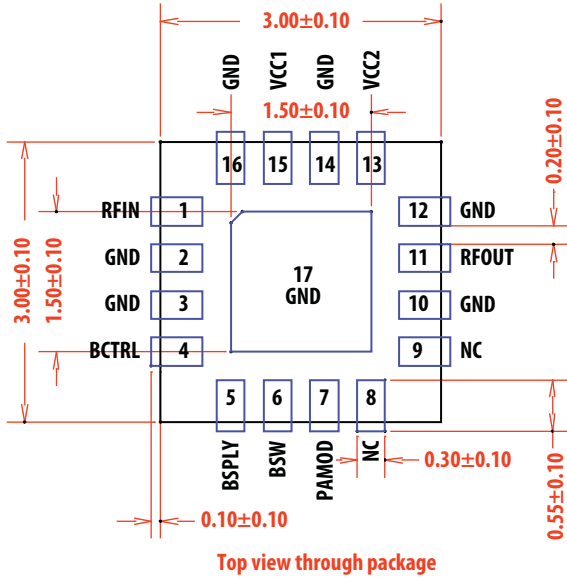

Figure 32. Recommended footprint

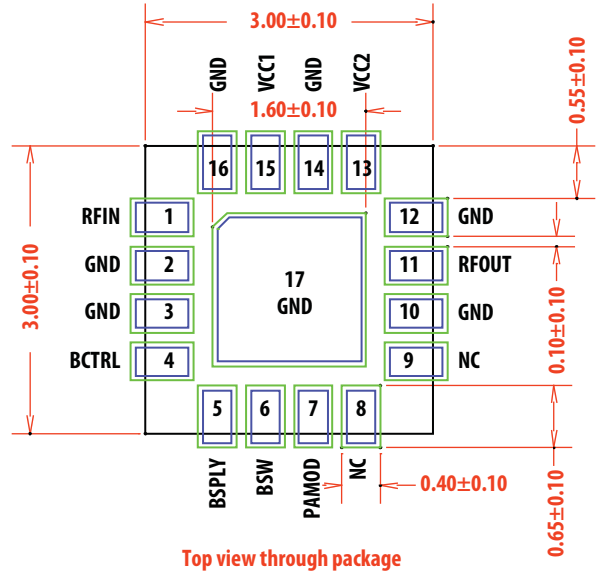

Figure 33. Recommended soldermask opening

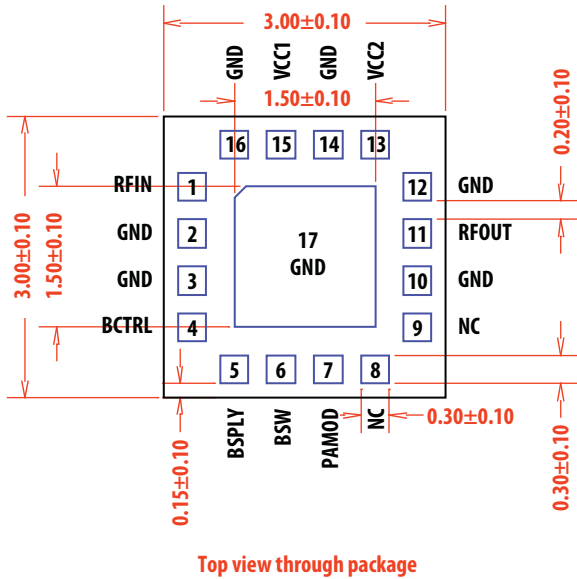
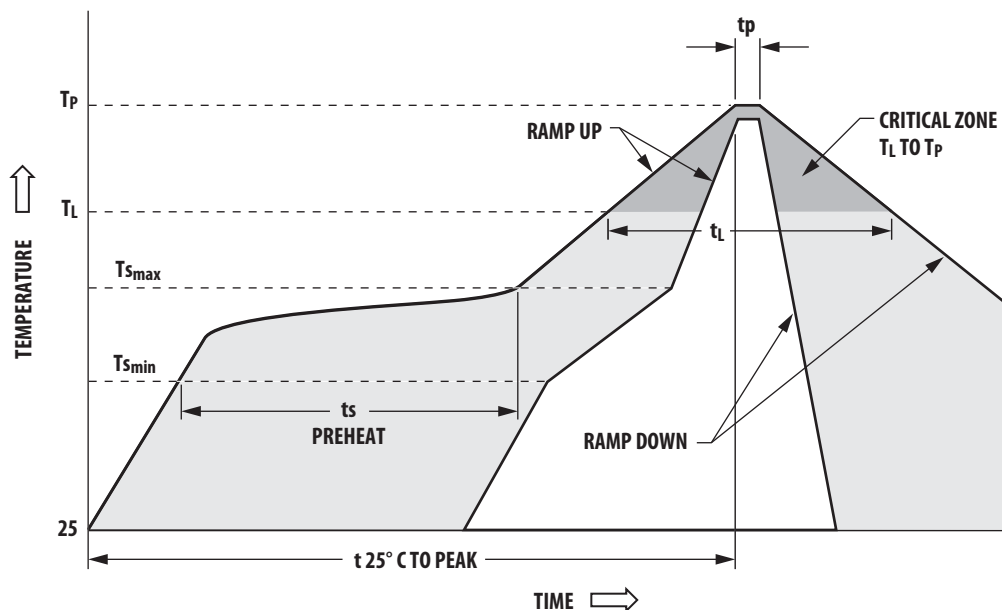

Figure 34. Package dimensions

- Notes:
1. All units are in millimeters
 2. Package is symmetrical

Handling and Storage

Typical SMT Reflow Profile for Maximum Temperature = $260 \pm 5^\circ\text{C}$



Profile Feature	Sn-Pb Solder	Pb-Free Solder
Average ramp-up rate (TL to TP)	3°C/sec max	3°C/sec max
Preheat		
– Temperature Min (T _{smin})	100° C	100° C
– Temperature Max (T _{smax})	150° C	150° C
– Time (mon to max) (t _s)	60-120 sec	60-180 sec
T _{smax} to T _L		
– Ramp-up Rate		3°C/sec max
Time maintained above:		
– Temperature (T _L)	183° C	217° C
– Time (T _L)	60-150 sec	60-150 sec
Peak temperature (T _p)	240 $\pm 5^\circ\text{C}$	260 $\pm 5^\circ\text{C}$
Time within 5° C of actual Peak Temperature (t _p)	10-30 sec	10-30 sec
Ramp-down Rate	6°C/sec max	6°C/sec max
Time 25° C to Peak Temperature	6 min max	8 min max

MGA-22103 Part Number Ordering Information

Part Number	Devices Per Container	Container
MGA-22103-BLKG	100	7" Reel
MGA-22103-TR1G	3000	13" Reel

Tape and Reel Information

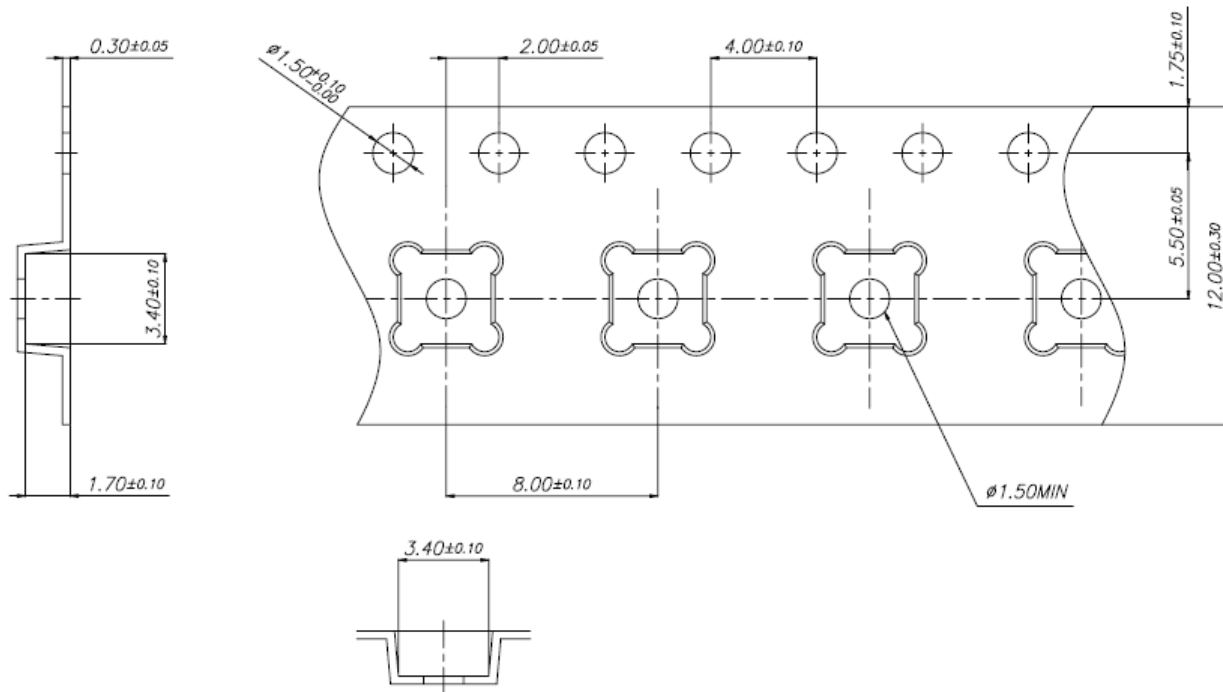
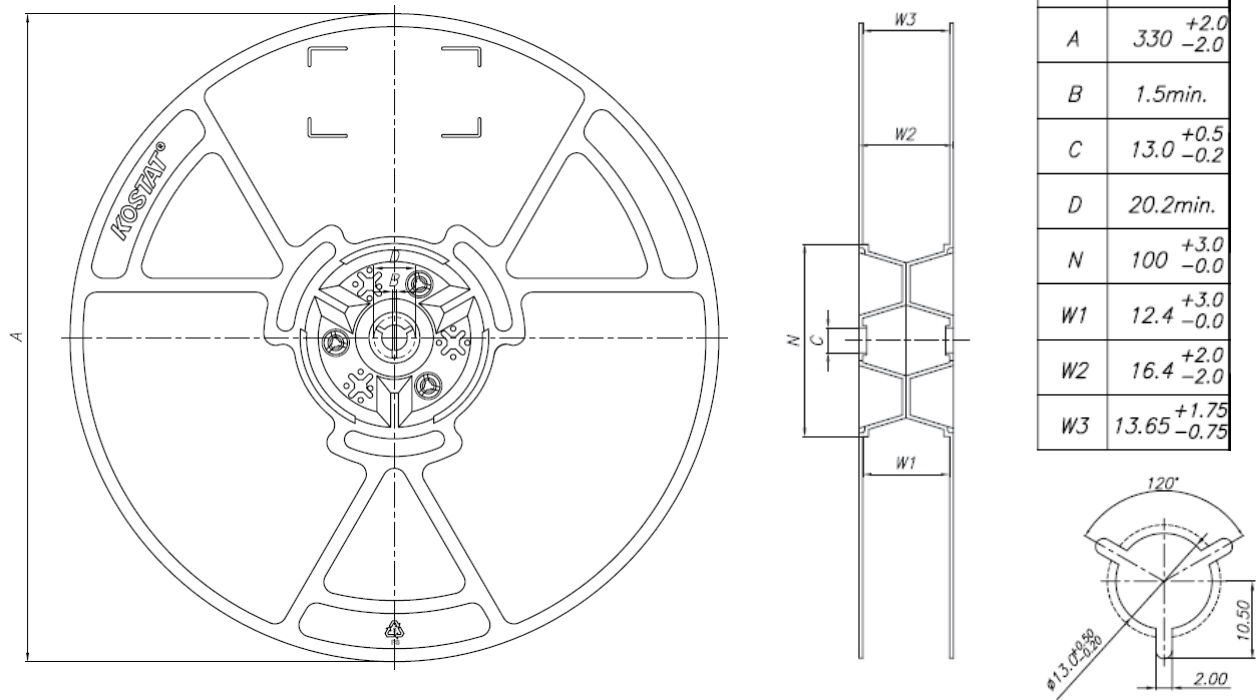

For product information and a complete list of distributors, please go to our web site: www.avagotech.com

Avago, Avago Technologies, and the A logo are trademarks of Avago Technologies in the United States and other countries.
 Data subject to change. Copyright © 2005-2011 Avago Technologies. All rights reserved.
 AV02-2812EN - June 28, 2011

