

# EC4SM-13.6864M

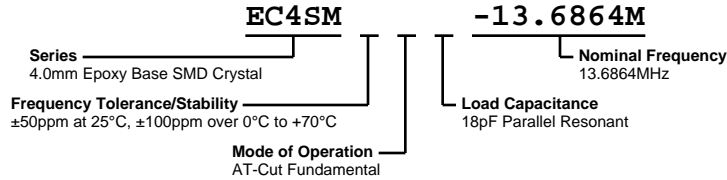

## ELECTRICAL SPECIFICATIONS

Nominal Frequency	13.6864MHz
Frequency Tolerance/Stability	±50ppm at 25°C, ±100ppm over 0°C to +70°C
Aging at 25°C	±5ppm/year Maximum
Load Capacitance	18pF Parallel Resonant
Shunt Capacitance (C0)	7pF Maximum
Equivalent Series Resistance	70 Ohms Maximum
Mode of Operation	AT-Cut Fundamental
Drive Level	1mWatts Maximum
Storage Temperature Range	-40°C to +85°C
Insulation Resistance	500 Megaohms Minimum at 100Vdc

## ENVIRONMENTAL & MECHANICAL SPECIFICATIONS

Fine Leak Test	MIL-STD-883, Method 1014 Condition A
Gross Leak Test	MIL-STD-883, Method 1014 Condition C
Mechanical Shock	MIL-STD-202, Method 213 Condition C
Resistance to Soldering Heat	MIL-STD-202, Method 210
Resistance to Solvents	MIL-STD-202, Method 215
Solderability	MIL-STD-883, Method 2003
Temperature Cycling	MIL-STD-883, Method 1010
Vibration	MIL-STD-883, Method 2007 Condition A

## MECHANICAL DIMENSIONS (all dimensions in millimeters)

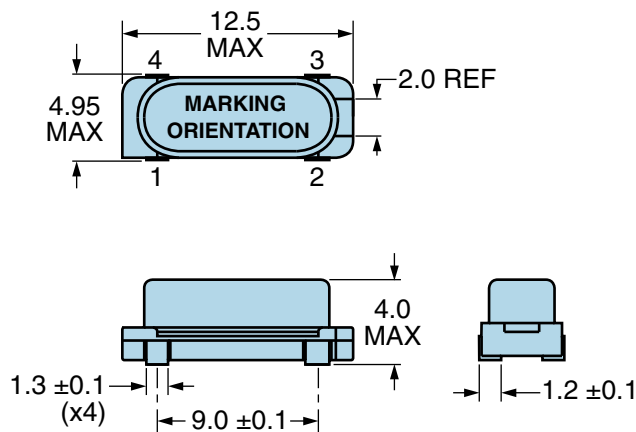

PIN	CONNECTION
1	Connected to Pin 4 and to Crystal
2	Connected to Pin 3 and to Crystal
3	Connected to Pin 2 and to Crystal
4	Connected to Pin 1 and to Crystal

LINE	MARKING
1	<b>E13.686</b> E=Ecliptek Designator

# EC4SM-13.6864M

## Suggested Solder Pad Layout

All Dimensions in Millimeters



All Tolerances are  $\pm 0.1$

## Recommended Solder Reflow Methods



### Low Temperature Infrared/Convection 225°C

**$T_S$  MAX to  $T_L$  (Ramp-up Rate)** 5°C/second Maximum

#### Preheat

- Temperature Minimum ( $T_S$  MIN) N/A
- Temperature Typical ( $T_S$  TYP) 150°C
- Temperature Maximum ( $T_S$  MAX) N/A
- Time ( $t_s$  MIN) 30 - 60 Seconds

**Ramp-up Rate ( $T_L$  to  $T_P$ )** 5°C/second Maximum

#### Time Maintained Above:

- Temperature ( $T_L$ ) 150°C
- Time ( $t_L$ ) 200 Seconds Maximum

**Peak Temperature ( $T_P$ )** 225°C Maximum

**Target Peak Temperature ( $T_P$  Target)** 225°C Maximum 2 Times

**Time within 5°C of actual peak ( $t_p$ )** 80 seconds Maximum 2 Times

**Ramp-down Rate** 5°C/second Maximum

**Time 25°C to Peak Temperature (t)** N/A

**Moisture Sensitivity Level** Level 1

### Low Temperature Manual Soldering

185°C Maximum for 10 seconds Maximum, 2 times Maximum.

### High Temperature Manual Soldering

260°C Maximum for 5 seconds Maximum, 2 times Maximum.