

.100"

SINGLE ROW

series 8129 varicon[®] plug/receptacle

MATES WITH SERIES 8129 AND 8229 PLUG

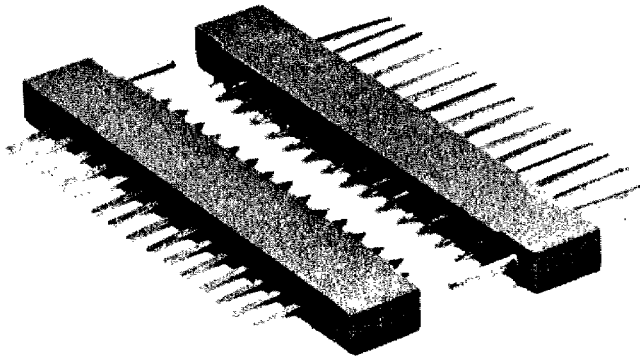

FEATURES

- Hermaphroditic connector design
- Parallel or perpendicular p.c. card mounting
- Brackets for flat or upright mounting
- Guide pins facilitate mating action
- Suitable for cable-to-cable applications
- For 1/16" p.c. card

SPECIFICATIONS

CURRENT RATING: 5 Amperes.

CONTACT RESISTANCE: 6 Milliohms, maximum

CONTACT MATERIAL AND PLATING:

Phosphor Bronze per QQ-B-750, Composition A.

†Gold, 10 microinches minimum, over nickel, 50 to 100 microinches

INSULATOR MATERIAL:

Diallyl Phthalate, glass-filled, flame resistant, per MIL-M-14F, Type SDGF

INSULATION RESISTANCE: 25,000 Megohms, minimum

DIELECTRIC WITHSTANDING VOLTAGE:

SEA LEVEL: 1,000 Volts RMS

3.4" Hg: 500 Volts RMS

INSERTION/WITHDRAWAL FORCE:

2 to 16 ounces per contact

MILITARY SPECIFICATIONS:

MIL-E-5400, MIL-E-8189, MIL-T-21200

MIL-E-19600 (BuWeps), Paragraph 3.5.5

ORDERING CODE FOR SERIES 8129

00 - 8129 - 006 - 610 - 001

• NUMBER OF CONTACTS:

006, 009, 010, 012, 015

• CONTACT CODE:

Use with Variant 001

610—60 8106 02 43



Use with Variant 002

603—60 8101 02 23



612—60 8106 03 23



Use with Variant 003

603—60 8101 02 23



605—60 8101 04 13



610—60 8106 02 43



612—60 8106 03 23



Use with Variant 004

605—60 8101 04 13



610—60 8106 02 43



• VARIANT CODE:

001—	with side mounting brackets for recessed or flush mounting to the edge of the p.c. card (contact tails are formed).
002—	with upright mounting brackets.
003—	without mounting brackets.
004—	with side mounting brackets for recessed or flush mounting to the edge of the p.c. card (contact tails are not formed).

Contact Factory For Special Variations.

Recommended for standard applications.
Available through ELCO franchised distributors.

ELCO Standard Plating shown. Other plating may be supplied on request.

BRACKET—UPRIGHT MTG.
PT. NO. 60 8129 41 11 00 062
(2 REQ'D—
SHIPPED LOOSE)

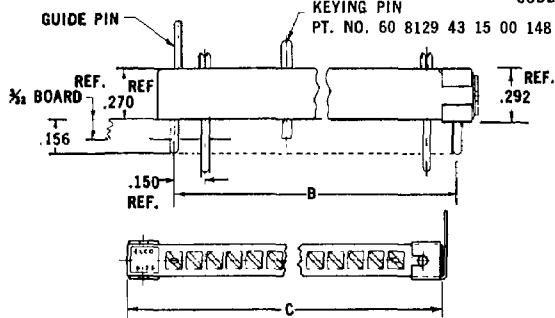
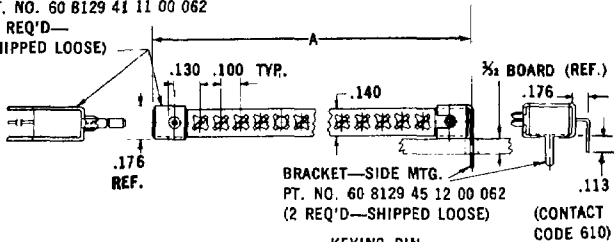

NO. OF CONTACTS	"A"	"B"	"C"
6	1.000	.800	.960
9	1.300	1.100	1.260
10	1.400	1.200	1.360
12	1.600	1.400	1.560
15	1.900	1.700	1.860

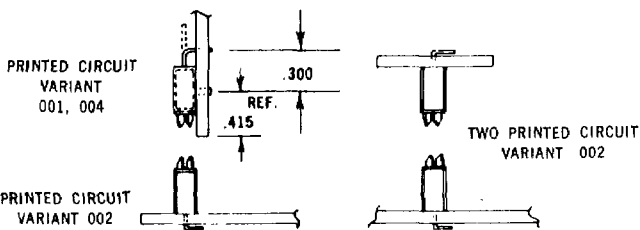

CABLE TO CABLE
VARIANT 003

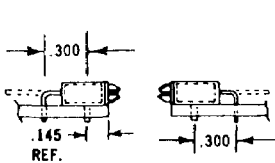

TWO PRINTED CIRCUIT VARIANTS
001, 004



CABLE VARIANT 003

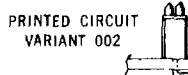

PRINTED CIRCUIT
VARIANT 002

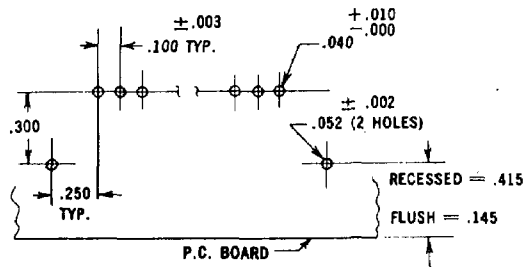

MOUNTING LAYOUT FOR VARIANT 001
and 004 SIDE MOUNTING

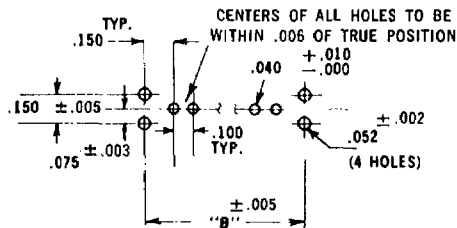

MOUNTING LAYOUT FOR VARIANT 002
UPRIGHT MOUNTING

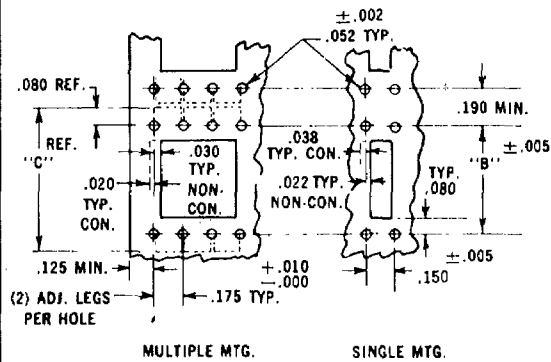

CLOSEST POSSIBLE SPACING
PANEL MOUNTING — VARIANT 002

Recommended for standard applications. Available through ELCO franchised distributors.