

REVISION AU
DO NOT SCALE FROM THIS PRINT

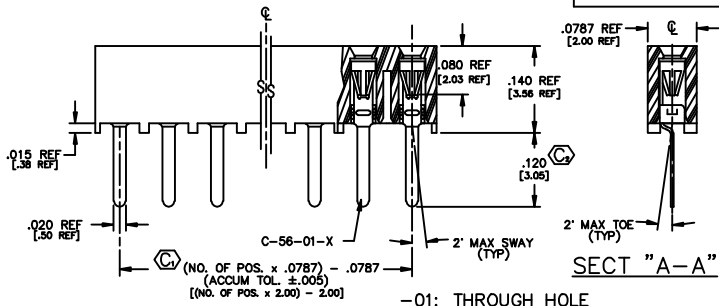

* PINS INTERLEAVED AND ORIENTED SAME DIRECTION FOR -01 ONLY

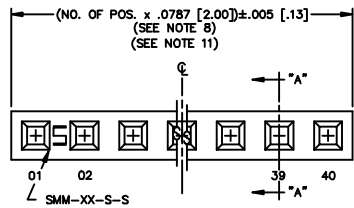
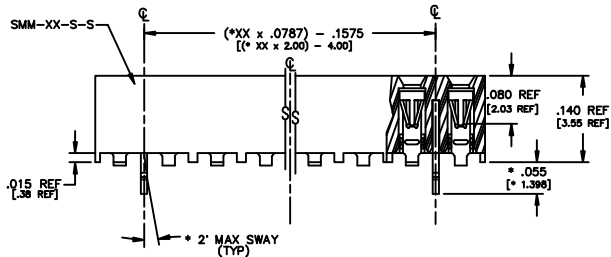
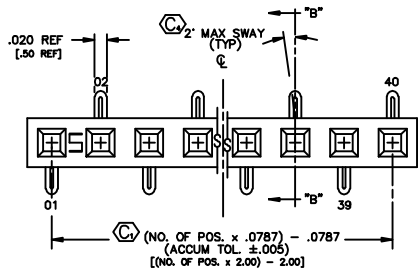

-02: SURFACE MOUNT

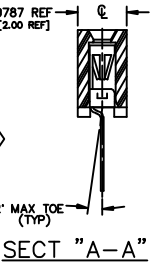
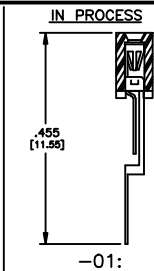

NOTES:

- RETENTION FORCE IN BODY TO BE: 1 lbs. MIN
- INSERTION FORCE TO BE: 3.0 oz. MAX.
- WITHDRAWAL FORCE TO BE: 0.4 oz. MIN.
- ⊗ REPRESENTS CRITICAL DIMS. FOR STATISTICAL PROCESS CONTROL.
- [] DIMS ARE IN METRIC AND ARE NOT CONTROLLING DIMS.
- SMM-105-01-X THRU SMM-140-01-X MUST USE PT-1-24-01-12.
- LC* OPTION FOR A 02 POSITION WILL HAVE ONLY ONE LOCKING CLIP (LC-05-T).
- *END WALLS* AFTER CUTTING SHOULD BE .017±.005.
- ALL OPTIONS: PACKAGE POSITIONS -04 THRU -40 IN TUBES. LAYER PACKAGE POSITIONS -02 & -03 WITH NO OPTIONS.
- 02 THRU -05 POSITION WITH -K OR -P TO BE PACKAGED IN -TR ONLY. -06 THRU -40 POSITION AVAILABLE IN TUBE OR -TR PACKAGING.
- MAX CUT FLASH: .010[.25]

TUBE PACKAGING TABLE

LEAD STYLE	TUBE	PLUG
-01	PT-1-24-01-12	TP-12
-01-P	PT-1-24-02-29	TP-24
-02		
-02-K, -02-LC, -02-LC-K	PT-SMM002-S-K	TP-24-02
-02-P	PT-SMM001-S-P	TP-24

PACKAGE PARTS IN TUBE AS SHOWN (POSITION PARTS WITH POS. -01 TOWARD ARROW AS SHOWN)

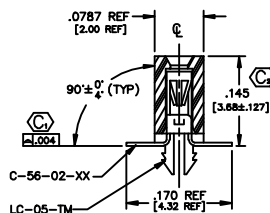
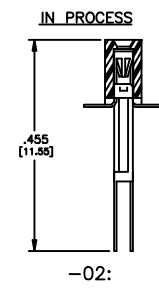

SECT "B-B"

DIMENSIONS ARE IN INCHES UNLESS OTHERWISE NOTED TOLERANCES ARE: ONE PLACE DECIMALS: ±.1 THREE PLACE DECIMALS: ±.005 TWO PLACE DECIMALS: ±.01 FOUR PLACE DECIMALS: ±.0020 ANGLES ± 1° TITLE: 2 mm SOCKET STRIP (SINGLE ROW) DWG NO: SMM-1XX-XX-XX-S-XX-X-XX-XX SHEET 1 OF 1

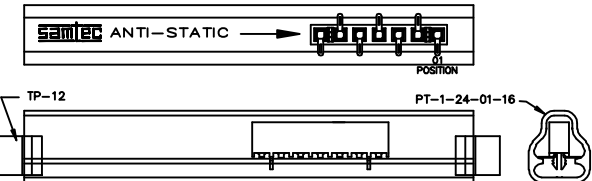
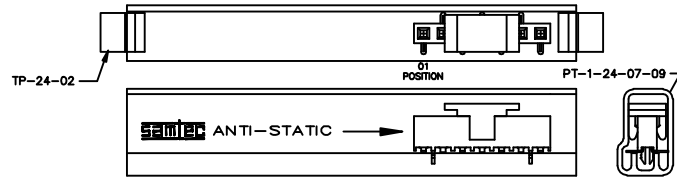
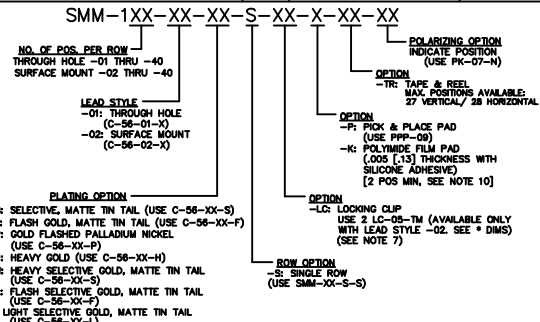

-K: POLYIMIDE FILM PAD [2 POSITION MINIMUM, SEE NOTE 10]

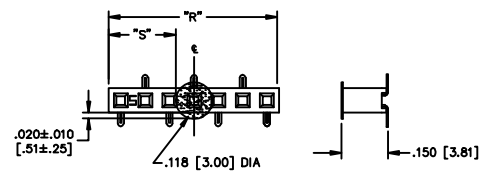

NOTE: "R" = USED MEASURED DIMENSION (REF)
"S" = {("R" - .118 [3.0]) / 2} ± .020 [.51]

1/2 SCALE

PROPRIETARY NOTE
THIS DOCUMENT AND THE INFORMATION CONTAINED HEREIN ARE UNCLASSIFIED EXCEPT WHERE SHOWN OTHERWISE. IT IS THE PROPERTY OF SAMTEC INC. AND IS LOANED TO YOUR ORGANIZATION. IT IS TO BE USED ONLY FOR THE PURPOSES AND DURATION SPECIFIED BY THE LOAN AGREEMENT. IT IS NOT TO BE REPRODUCED, COPIED, OR DISSEMINATED IN ANY MANNER WITHOUT THE WRITTEN CONSENT OF SAMTEC INC.

samtec
520 PARK EAST BLVD. NEW ALBANY, INDIANA 47150
PHONE (812) 944-8733 P.O. BOX 1147
CODE 55322
MADE BY MATT KOURI S-22-BL CHECKED BY: McCARTIN
DREM
SMM-1XX-XX-XX-S-XX-X-XX-XX SHEET 1 OF 1