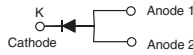

High Current Density Surface Mount Glass Passivated Rectifiers

eSMP® Series

TO-277A (SMPC)

FEATURES

- Very low profile - typical height of 1.1 mm
- Ideal for automated placement
- Glass passivated chip junction
- Low forward voltage drop
- High surge capability
- Meets MSL level 1, per J-STD-020, LF maximum peak of 260 °C
- AEC-Q101 qualified
- Material categorization: For definitions of compliance please see www.vishay.com/doc?99912

 AUTOMOTIVE
GRADE
Available

RoHS
COMPLIANT
HALOGEN
FREE
TYPICAL APPLICATIONS

For use in general purpose rectification of power supplies, inverters, converters and freewheeling diodes for consumer, automotive, and telecommunication.

MECHANICAL DATA

Case: TO-277A (SMPC)

Molding compound meets UL 94 V-0 flammability rating
Base P/N-M3 - halogen-free, RoHS compliant, and commercial grade

Base P/NHM3 - halogen-free, RoHS compliant, and automotive grade

Terminals: Matte tin plated leads, solderable per J-STD-002 and JESD 22-B102

M3 suffix meets JESD 201 class 1A whisker test, HM3 suffix meets JESD 201 class 2 whisker test

PRIMARY CHARACTERISTICS

$I_{F(AV)}$	4.0 A
V_{RRM}	100 V to 1000 V
I_{FSM}	100 A
I_R	10 μ A
V_F at $I_F = 4$ A	0.860 V
T_J max.	150 °C

MAXIMUM RATINGS ($T_A = 25$ °C unless otherwise noted)

PARAMETER	SYMBOL	S4PB	S4PD	S4PG	S4PJ	S4PK	S4PM	UNIT
Device marking code		S4PB	S4PD	S4PG	S4PJ	S4PK	S4PM	
Maximum repetitive peak reverse voltage	V_{RRM}	100	200	400	600	800	1000	V
Average forward current	$I_{F(AV)}$	4.0						A
Peak forward surge current 10 ms single half sine-wave superimposed on rated load	I_{FSM}	100						A
Operating junction and storage temperature range	T_J, T_{STG}	- 55 to + 150						°C



ELECTRICAL CHARACTERISTICS ($T_A = 25\text{ }^\circ\text{C}$ unless otherwise noted)						
PARAMETER	TEST CONDITIONS	SYMBOL	TYP.	MAX.	UNIT	
Instantaneous forward voltage	$I_F = 2.0\text{ A}$	$T_A = 25\text{ }^\circ\text{C}$	$V_F^{(1)}$	0.897	-	V
	$I_F = 4.0\text{ A}$			0.958	1.10	
	$I_F = 2.0\text{ A}$	$T_A = 125\text{ }^\circ\text{C}$		0.783	-	
	$I_F = 4.0\text{ A}$			0.860	0.95	
Reverse current	Rated V_R	$T_A = 25\text{ }^\circ\text{C}$	$I_R^{(2)}$	-	10	μA
		$T_A = 125\text{ }^\circ\text{C}$		55	100	
Maximum reverse recovery time	$I_F = 0.5\text{ A}$, $I_R = 1.0\text{ A}$, $I_{rr} = 0.25\text{ A}$	t_{rr}	2.5	-	μs	
Typical junction capacitance	4.0 V, 1 MHz	C_J	30	-	pF	

Notes

- (1) Pulse test: 300 μs pulse width, 1 % duty cycle
(2) Pulse test: Pulse width $\leq 40\text{ ms}$

THERMAL CHARACTERISTICS ($T_A = 25\text{ }^\circ\text{C}$ unless otherwise specified)								
PARAMETER	SYMBOL	S4PB	S4PD	S4PG	S4PJ	S4PK	S4PM	UNIT
Typical thermal resistance	$R_{\theta JA}^{(1)}$	60						$^\circ\text{C/W}$
	$R_{\theta JL}$	4						

Note

- (1) Units mounted on recommended PCB 1 oz. pad layout

ORDERING INFORMATION (Example)				
PREFERRED P/N	UNIT WEIGHT (g)	PACKAGE CODE	BASE QUANTITY	DELIVERY MODE
S4PJ-M3/86A	0.10	86A	1500	7" diameter plastic tape and reel
S4PJ-M3/87A	0.10	87A	6500	13" diameter plastic tape and reel
S4PJHM3/86A ⁽¹⁾	0.10	86A	1500	7" diameter plastic tape and reel
S4PJHM3/87A ⁽¹⁾	0.10	87A	6500	13" diameter plastic tape and reel

Note

- (1) Automotive grade



RATINGS AND CHARACTERISTICS CURVES

($T_A = 25\text{ }^\circ\text{C}$ unless otherwise noted)

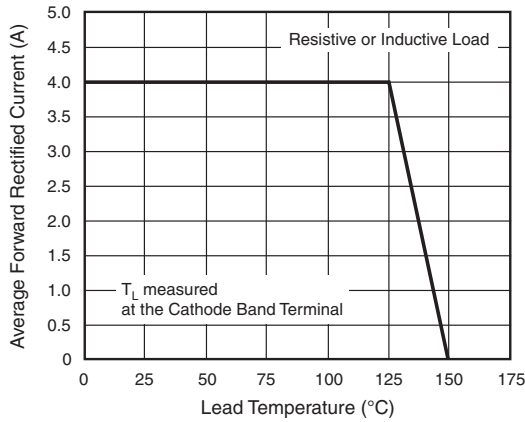

Fig. 1 - Maximum Forward Current Derating Curve

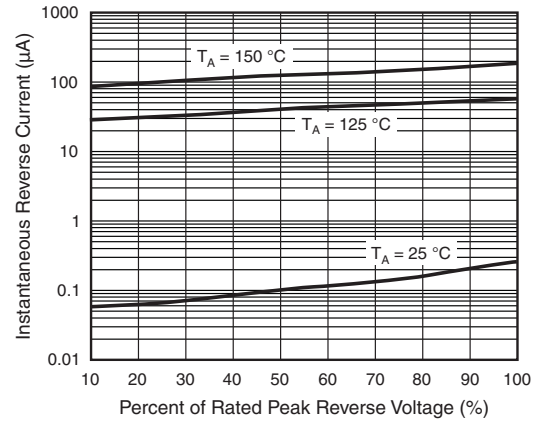

Fig. 4 - Typical Reverse Leakage Characteristics

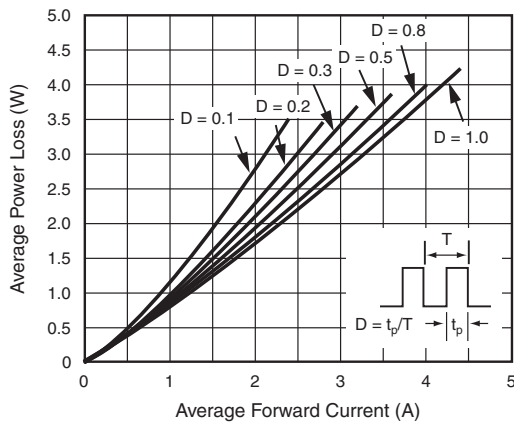

Fig. 2 - Forward Power Loss Characteristics

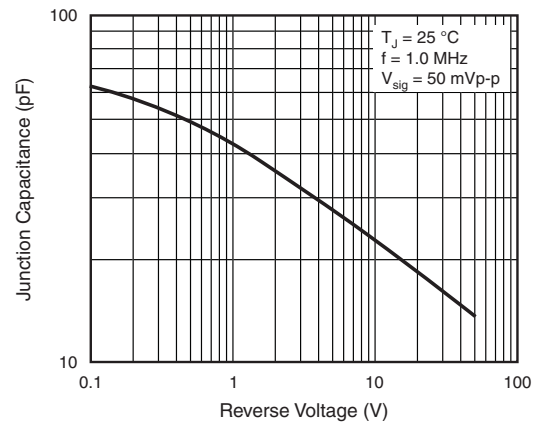

Fig. 5 - Typical Junction Capacitance

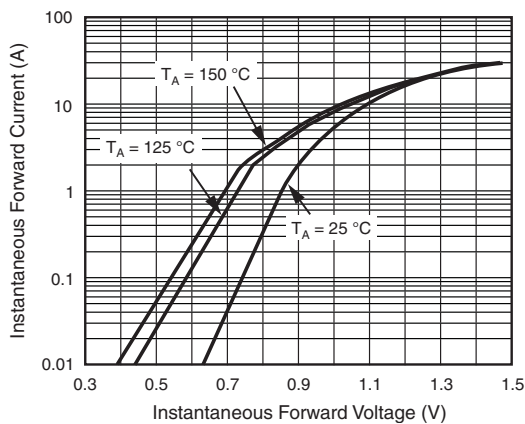

Fig. 3 - Typical Instantaneous Forward Characteristics

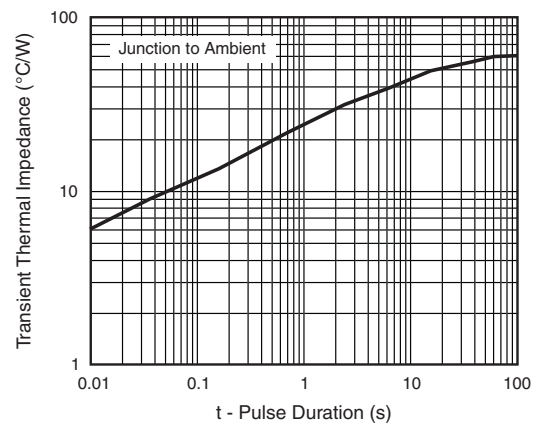
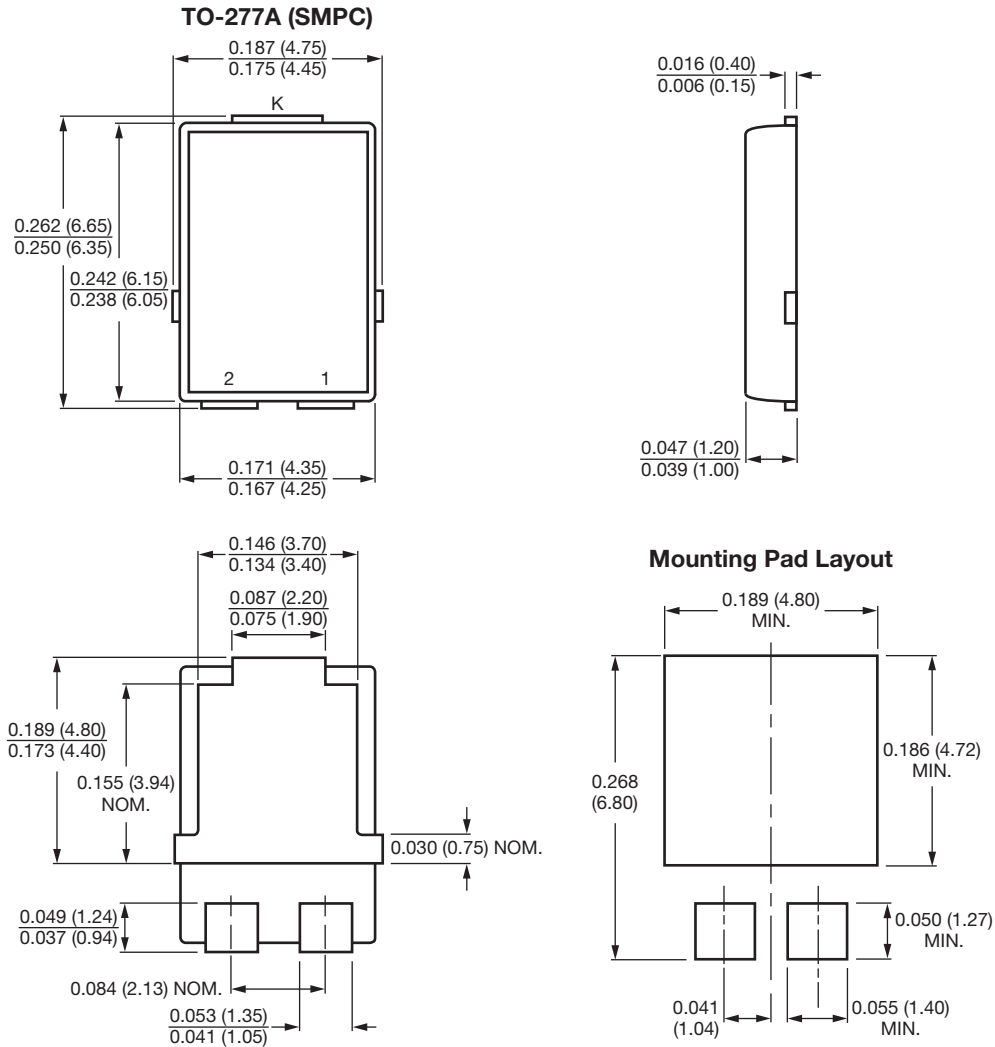

Fig. 6 - Typical Transient Thermal Impedance



PACKAGE OUTLINE DIMENSIONS in inches (millimeters)



Conform to JEDEC TO-277A



Disclaimer

ALL PRODUCT, PRODUCT SPECIFICATIONS AND DATA ARE SUBJECT TO CHANGE WITHOUT NOTICE TO IMPROVE RELIABILITY, FUNCTION OR DESIGN OR OTHERWISE.

Vishay Intertechnology, Inc., its affiliates, agents, and employees, and all persons acting on its or their behalf (collectively, "Vishay"), disclaim any and all liability for any errors, inaccuracies or incompleteness contained in any datasheet or in any other disclosure relating to any product.

Vishay makes no warranty, representation or guarantee regarding the suitability of the products for any particular purpose or the continuing production of any product. To the maximum extent permitted by applicable law, Vishay disclaims (i) any and all liability arising out of the application or use of any product, (ii) any and all liability, including without limitation special, consequential or incidental damages, and (iii) any and all implied warranties, including warranties of fitness for particular purpose, non-infringement and merchantability.

Statements regarding the suitability of products for certain types of applications are based on Vishay's knowledge of typical requirements that are often placed on Vishay products in generic applications. Such statements are not binding statements about the suitability of products for a particular application. It is the customer's responsibility to validate that a particular product with the properties described in the product specification is suitable for use in a particular application. Parameters provided in datasheets and/or specifications may vary in different applications and performance may vary over time. All operating parameters, including typical parameters, must be validated for each customer application by the customer's technical experts. Product specifications do not expand or otherwise modify Vishay's terms and conditions of purchase, including but not limited to the warranty expressed therein.

Except as expressly indicated in writing, Vishay products are not designed for use in medical, life-saving, or life-sustaining applications or for any other application in which the failure of the Vishay product could result in personal injury or death. Customers using or selling Vishay products not expressly indicated for use in such applications do so at their own risk. Please contact authorized Vishay personnel to obtain written terms and conditions regarding products designed for such applications.

No license, express or implied, by estoppel or otherwise, to any intellectual property rights is granted by this document or by any conduct of Vishay. Product names and markings noted herein may be trademarks of their respective owners.

Material Category Policy

Vishay Intertechnology, Inc. hereby certifies that all its products that are identified as RoHS-Compliant fulfill the definitions and restrictions defined under Directive 2011/65/EU of The European Parliament and of the Council of June 8, 2011 on the restriction of the use of certain hazardous substances in electrical and electronic equipment (EEE) - recast, unless otherwise specified as non-compliant.

Please note that some Vishay documentation may still make reference to RoHS Directive 2002/95/EC. We confirm that all the products identified as being compliant to Directive 2002/95/EC conform to Directive 2011/65/EU.

Vishay Intertechnology, Inc. hereby certifies that all its products that are identified as Halogen-Free follow Halogen-Free requirements as per JEDEC JS709A standards. Please note that some Vishay documentation may still make reference to the IEC 61249-2-21 definition. We confirm that all the products identified as being compliant to IEC 61249-2-21 conform to JEDEC JS709A standards.