

The future of video is DVI

applications

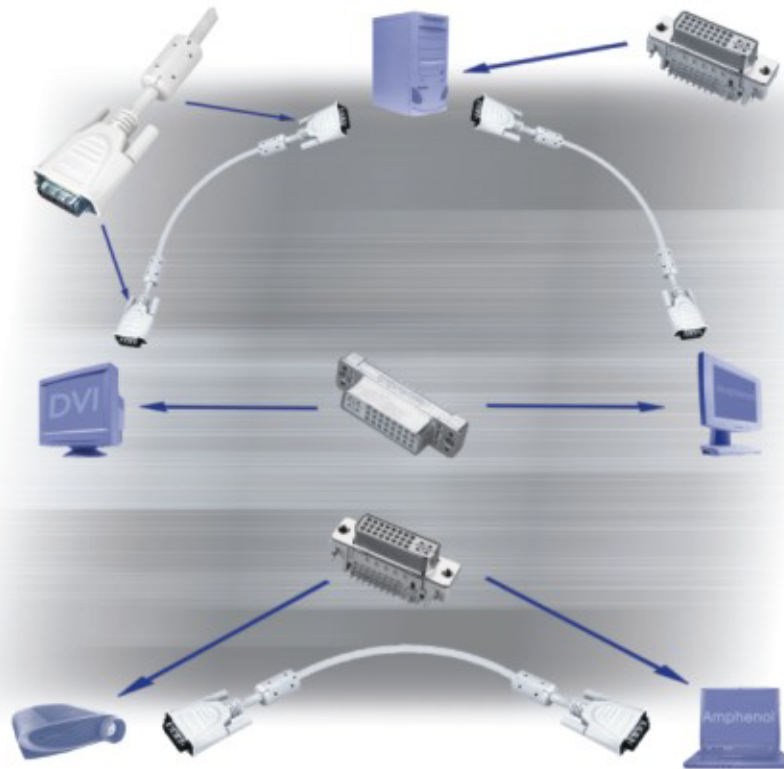

features & benefits

fully compliant with DDWG DVI rev. 1.0

supports single and dual link digital signaling, which allows high speed digital transmissions of 4.95 Gbps or 9.9 Gbps

analog coaxial lines allow high speed analog transmission (2.5 GHz)

protruding shield enables first-make-last break for ESD protection

fully shielded front shell structure for excellent EMI/RFI protection

rugged and reliable contact design provides two points of contact for optimal signal integrity and reduces insertion force to ensure high reliability

plug-and-play compliant



DVI is developed by the Digital Display Working Group (www.ddwg.org), an open industry forum group formed by Intel, Compaq, Fujitsu, Hewlett Packard, IBM, NEC and Silicon Image. The goal is to formalize a standard for digital video connectivity in hope that a better compatibility and peak performance can be experienced by all users who demand high quality video output.

Note: Amphenol constantly strives to improve and provide our customers with the most advanced and quality products. Therefore, some products may change without prior notice. Please contact a representative or visit us online for the most up-to-date information.

DVI connectors

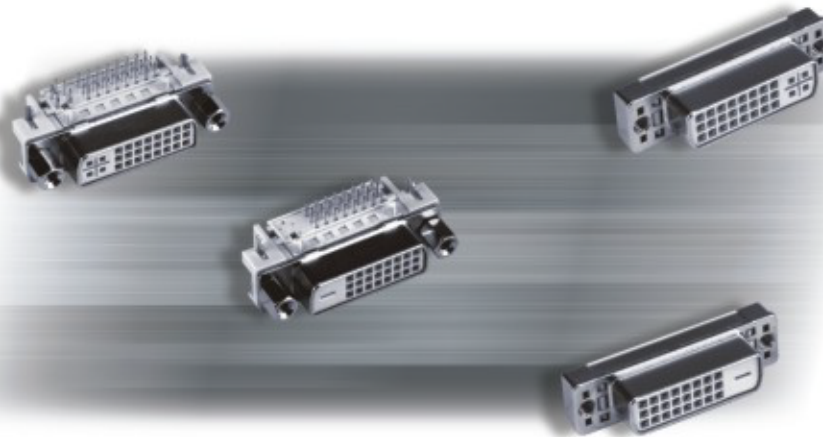
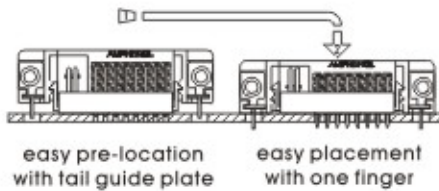
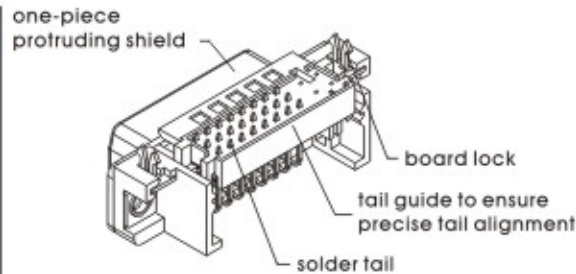
features
(receptacle)

electrical

contact resistance: 20m Ω maximum initial per mated pair, 10m Ω maximum change from original per mated pair

dielectric withstanding voltage: 500/50 Vdc

insulation resistance: 1G Ω minimum between adjacent contacts and between contacts and shell

contact current rating: 1.5 amperes per contact

physical
&
mechanical

receptacle front shell and bracket: zinc alloy, min. 100 μ m nickel or tin/lead plated

insulator: P.B.T., 30% glass-filled, UL94V-0 rated

contact: phosphor bronze

contact finish*:

- mating area: gold (see ordering information for available thicknesses)
- termination area: minimum 100 μ m tin/lead

grounding blade: brass, gold flash plated

mating force: 4.5 kg max. per connector

unmating force: 1kg min., 4kg max per connector

durability: 100 cycles per ANSI/EIA-364-09

grounding post: brass, min. 100 μ m tin/lead plated

arrowhead board lock: phosphor bronze, minimum 100 μ m tin/lead plated

screw lock: brass, minimum 100 μ m nickel plated

* All metal parts are with a minimum 50 μ m nickel under-plate.

receptacle options

signal interface options

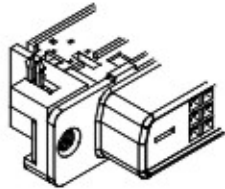

digital
right-angle PCB mount

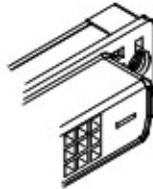

digital
vertical PCB mount

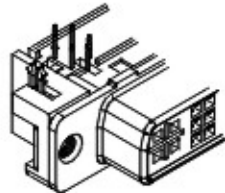

integrated
right-angle PCB mount

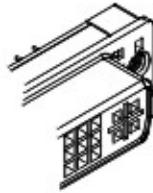

integrated
vertical PCB mount

board mount options

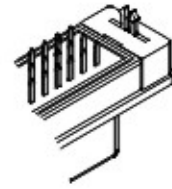

arrowhead board lock
vertical PCB mount

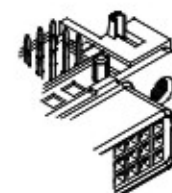

grounding post with locator
right-angle PCB mount

flange mount option

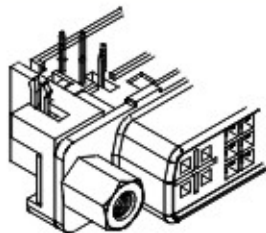

right-angle mount
with hex screw lock



vertical mount
with hex screw lock

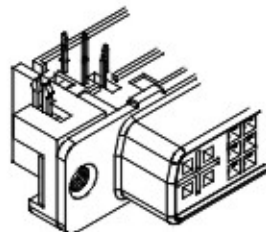

right-angle
without hex screw lock

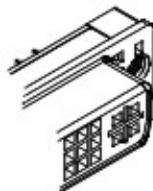

vertical mount
without hex screw lock



arrowhead board lock (ϕ 1.93mm)
with locator
right-angle PCB mount

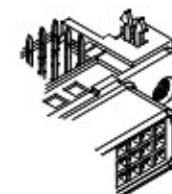

arrowhead board lock (ϕ 3.17mm)
without locator
right-angle PCB mount

DVI connector - receptacles

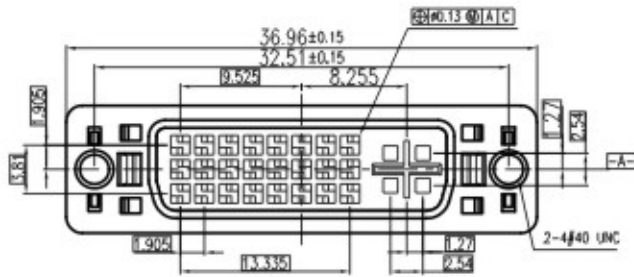

integrated DVI straight receptacle

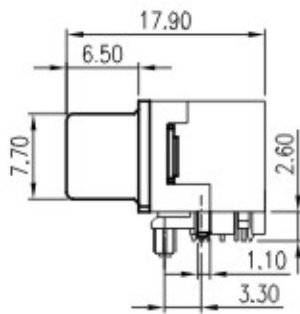
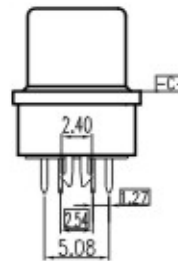
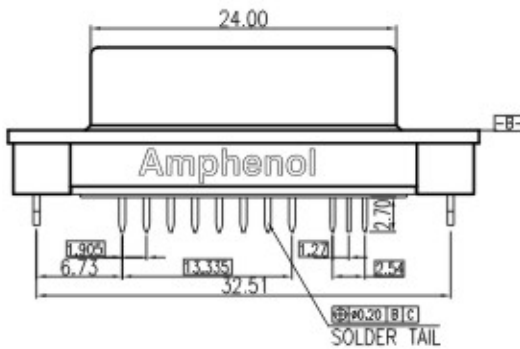

DVI integrated receptacle right angle mount with grounding posts and locators

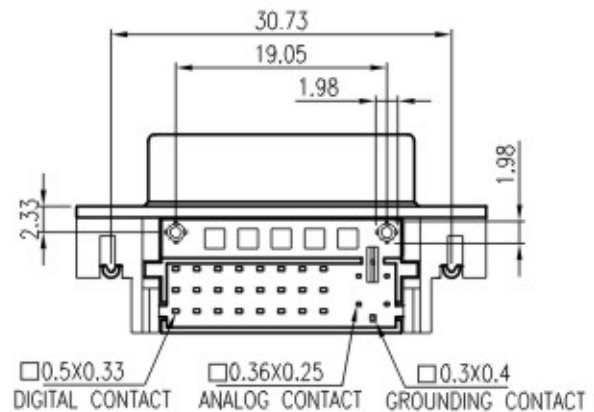
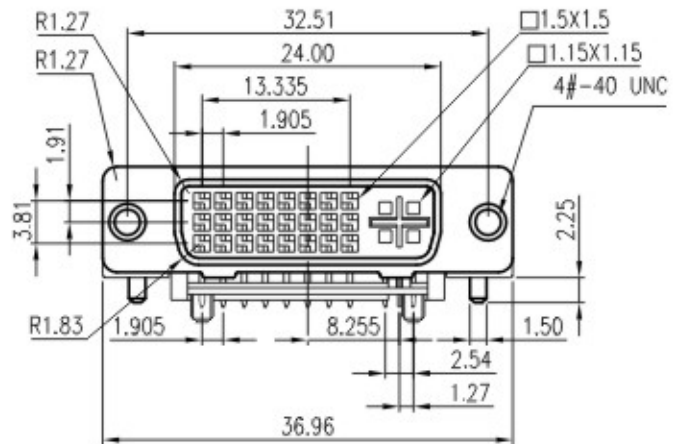

□0.5X0.33 DIGITAL CONTACT □0.36X0.25 ANALOG CONTACT □0.3X0.4 GROUNDING CONTACT

recommended PCB layouts

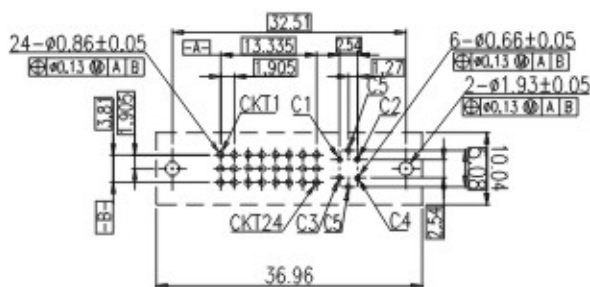
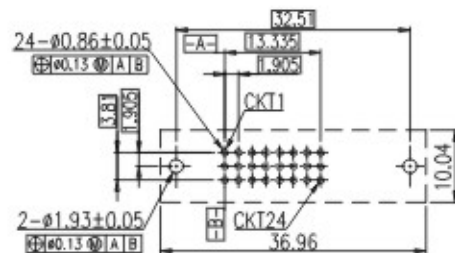
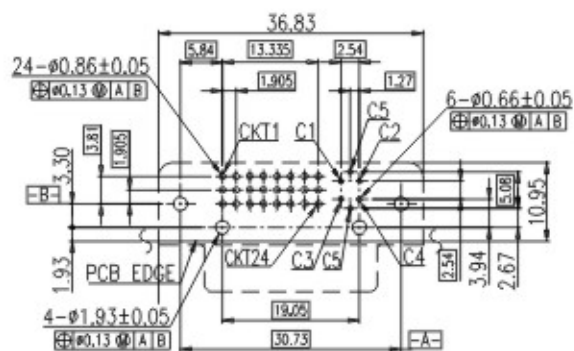
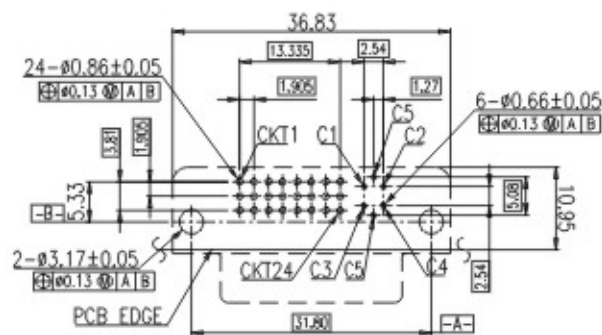
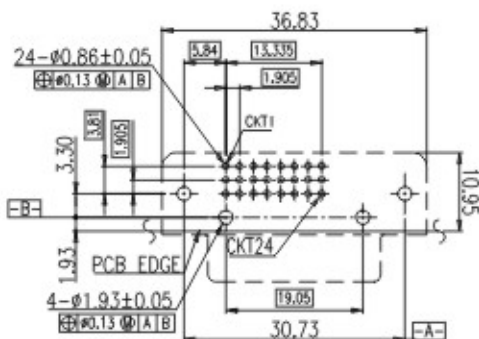
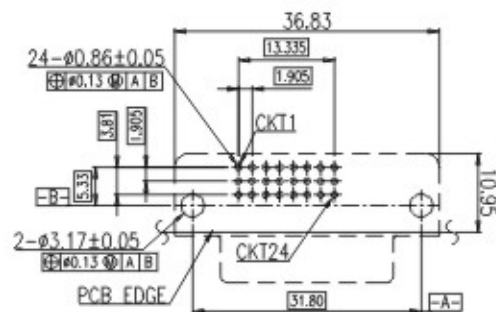
integrated (29 pos.)
vertical mountdigital (24 pos.)
vertical mountintegrated (29 pos.)
right-angle mount with locatorsintegrated (29 pos.)
right-angle mount without locatorsdigital (24 pos.)
right-angle mount with locatorsdigital (24 pos.)
right-angle mount without locators

DVI connectors - plugs

plug options

pin arrangement options

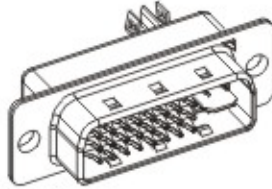

29 pins (24+4+1)
integrated

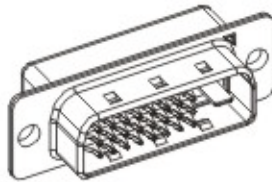

25 pins (24+ key)
digital

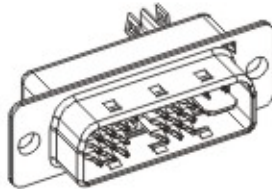

23 pins (18+4+1)
integrated

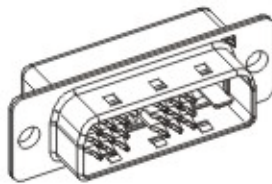

19 pins (18+ key)
digital

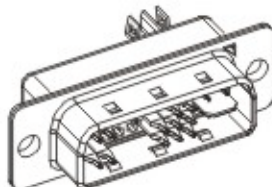

17 pins (12+4+1)
analog

DVI integrated plug

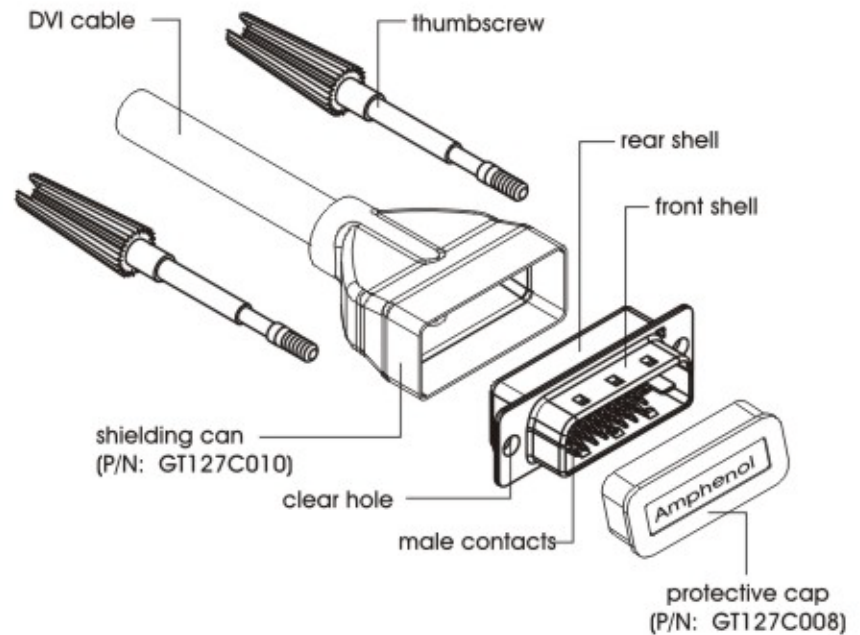
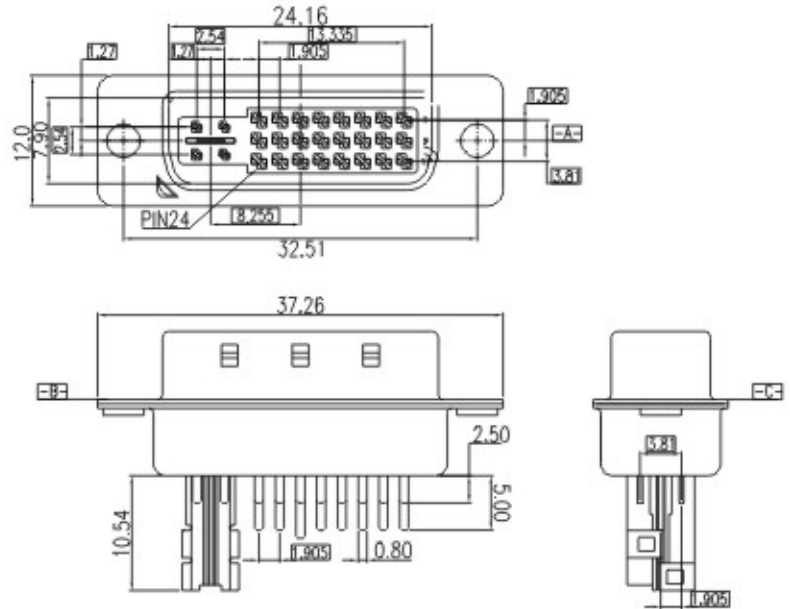

DVI connectors

ordering information

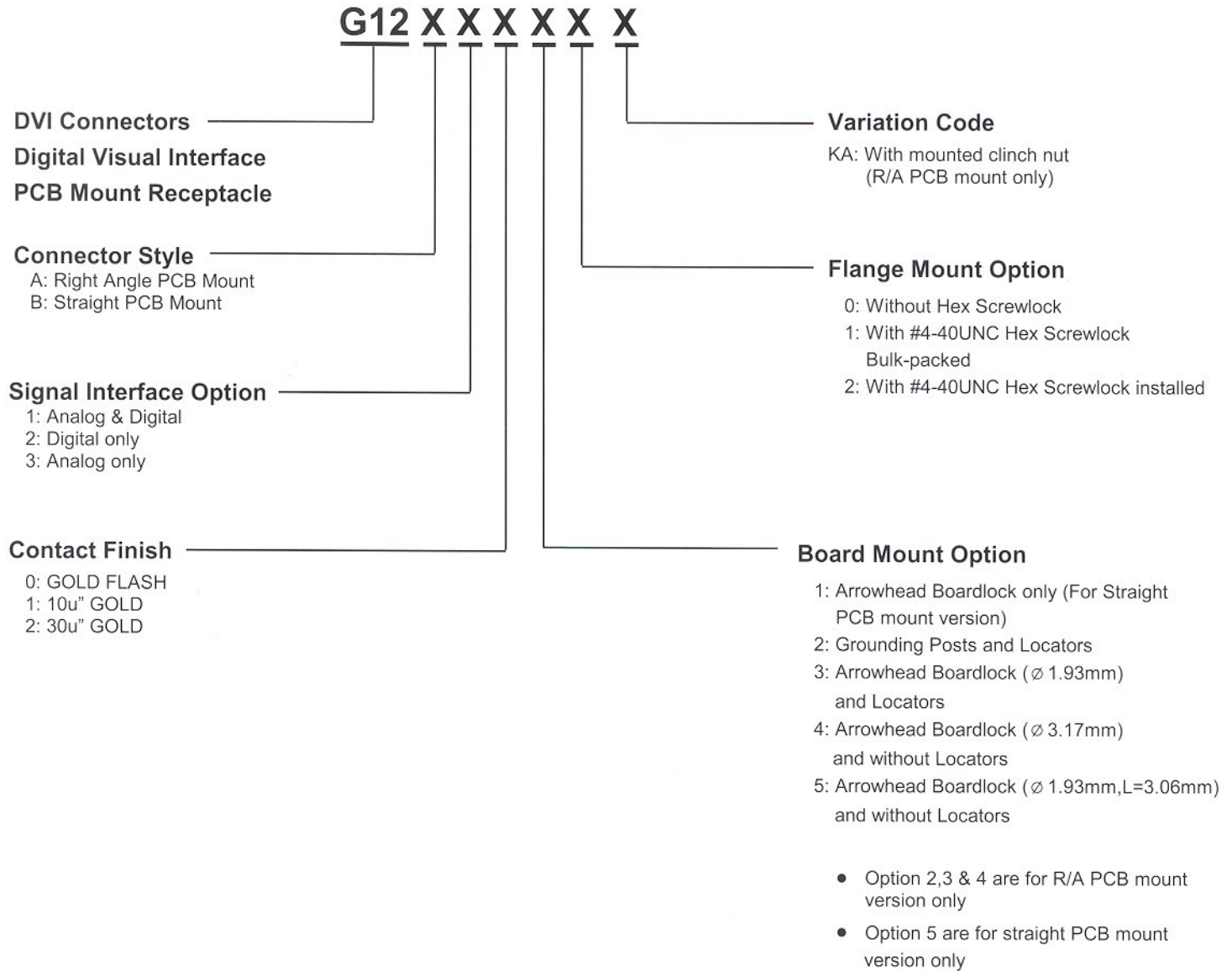

- Notes:
- ALL CONTACTS ARE IN 50μ" NICKEL UNDERPLATE
 - ALL SPECIFIED NUMBERS ARE MINIMUM THICKNESS OF PLATING.
 - THE VARIATION CODE MAY SUPERSEDE SOME MAJOR SPECIFICATIONS DEFINED BY THIS STANDARD PART NUMBER SYSTEM. FOR PART NUMBER WITH A VARIATION CODE. PLEASE REFER TO THE SPECIFIC SET OF DATASHEETS RELEASED FOR THAT VARIATION CODE.

DVI cable assembly

options diagram



DVI-analog

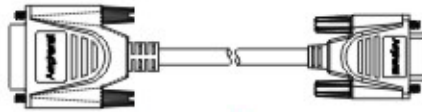

GCA75XX 0 XX

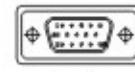

VGA

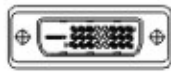

DVI-digital

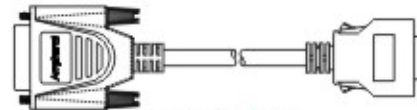

GCA75XX 1 XX

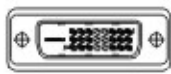
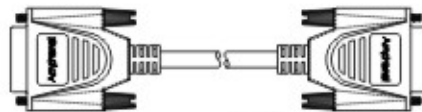

DFP

DVI-digital
single link

GCA75XX 2 XX

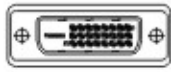
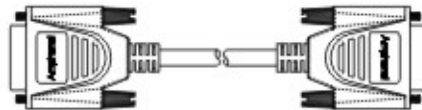
DVI-digital
single linkDVI-digital
dual link

GCA75XX 3 XX

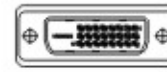
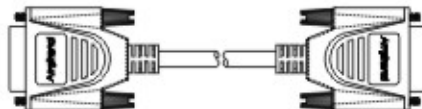
DVI-digital
dual linkDVI-digital
/analog

GCA75XX 4 XX

DVI-digital
/analog

DVI-analog

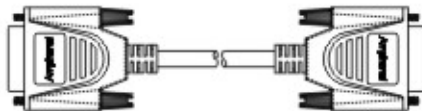

GCA75XX 5 XX



DVI-analog

ordering information

GCA75 XX X XX

cable assemblies
over mold type

serial number

factory assigned code

optional for cable type as indicated by
red code on the above drawing

DVI cable assemblies



material & finish

over-molded boot: molded PVC, UL94V-0 rated,
color - ivory

thumbscrew: steel, minimum 80 μ " nickel plated

thumbscrew cap: ABS, color - ivory

harness type: digital single link, digital dual link,
digital/analog integrated and analog

mechanical

pull test: cable assemblies withstand a pull force of
89–111 N for 30 seconds with no visible termination
damage

flex test: no electrical discontinuity or visible
termination damage occurs during and after flexing
the cable assembly for 100 cycles at each of the

electrical

DVI plugs

refer to G12C specification given in previous pages

cable

dielectric withstanding voltage: 500 Vdc for 1 minute

insulation resistance: 100 m Ω minimum

differential lines characteristic impedance: 100 \pm 5 Ω

differential lines mutual capacitance: 14.0 pf/ft nominal

T.M.D.S. & RGB electrical specification

T.M.D.S. signal time domain impedance: 100 Ω \pm 15%

T.M.D.S. signal time domain crosstalk (fext): 5% maximum

T.M.D.S. signal rise time degradation: 160 ps maximum

RGB coaxial signal time domain impedance: 75 Ω \pm 15%

RGB coaxial signal time domain crosstalk (fext): 3% maximum

environmental

thermal shock: per ANSI/EIA-364-32 condition 1

cyclic humidity: 10 cycles, per ANSI/EIA-364-31 condition a and b

temperature life: per ANSI/EIA 364-17 condition 4, 105 $^{\circ}$ C for 250 hrs

operating temperature: -20 $^{\circ}$ C to 85 $^{\circ}$ C

storage temperature: -20 $^{\circ}$ C to 85 $^{\circ}$ C

DVI adaptors

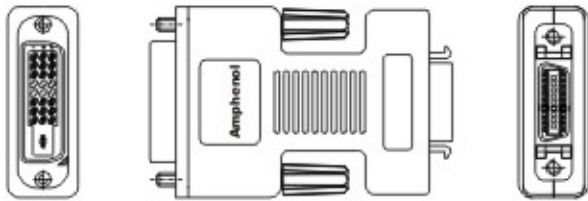

DVI-analog plug

P/N: G12P002

VGA receptacle

refer to Amphenol datasheet **PS-7096** for detailed specifications

refer to Amphenol datasheet **PS-7097** for detailed specifications

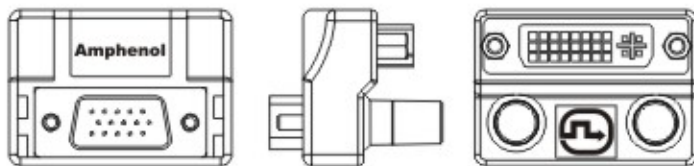

VGA (D-sub) plug

P/N: G12P003

DVI-digital / analog

refer to Amphenol datasheet **PS-7104** for detailed specifications

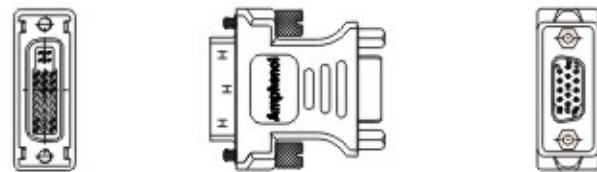

DVI-analog plug

P/N: G12P004

VGA receptacle

refer to Amphenol datasheet **PS-7171** for detailed specifications