

Optocoupler, Phototriac Output

Features

- $I_{TRMS} = 300 \text{ mA}$
- High Static $dV_{crq}/dt < 10,000 \text{ V}/\mu\text{s}$
- Electrically Insulated between Input and output circuit
- Microcomputer compatible - Very Low Trigger Current
- Non-zero voltage detectors High input Sensitivity
- Lead (Pb)-free component
- Component in accordance to RoHS 2002/95/EC and WEEE 2002/96/EC

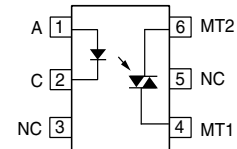
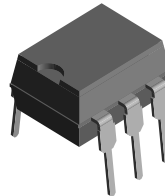

1179041

Agency Approvals

- UL1577, File No. E52744 System Code J
- DIN EN 60747-5-2 (VDE0884)
DIN EN 60747-5-5 pending
Available with Option 1

Applications

Industrial controls
Office equipment
Consumer appliances

Description

The BRT11/12/13 are AC optocouplers non-zero voltage detectors consisting of two electrically insulated lateral power ICs which integrate a thyristor system, a photo detector and noise suppression at the output and an IR GaAs diode input.

Order Information

Part	Remarks
BRT12-F	600 V V_{DRM} , 1.2 mA I_{FT} , DIP-6
BRT11-H	400 V V_{DRM} , 2 mA I_{FT} , DIP-6
BRT12-H	600 V V_{DRM} , 2 mA I_{FT} , DIP-6
BRT13-H	800 V V_{DRM} , 2 mA I_{FT} , DIP-6
BRT11-M	400 V V_{DRM} , 3 mA I_{FT} , DIP-6
BRT12-M	600 V V_{DRM} , 3 mA I_{FT} , DIP-6
BRT13-M	800 V V_{DRM} , 3 mA I_{FT} , DIP-6
BRT12-F-X006	600 V V_{DRM} , 1.2 mA I_{FT} , DIP-6 400 mil (option 6)
BRT12-F-X007	600 V V_{DRM} , 1.2 mA I_{FT} , DIP-6 400 mil (option 7)
BRT12-H-X006	600 V V_{DRM} , 2 mA I_{FT} , DIP-6 400 mil (option 6)
BRT12-H-X007	600 V V_{DRM} , 2 mA I_{FT} , SMD-6 (option 7)
BRT12-H-X009	600 V V_{DRM} , 2 mA I_{FT} , SMD-6 (option 9)
BRT13-H-X006	800 V V_{DRM} , 2 mA I_{FT} , DIP-6 400 mil (option 6)
BRT13-H-X007	800 V V_{DRM} , 2 mA I_{FT} , SMD-6 (option 7)
BRT13-H-X009	800 V V_{DRM} , 2 mA I_{FT} , SMD-6 (option 9)
BRT12-M-X006	600 V V_{DRM} , 3 mA I_{FT} , DIP-6 400 mil (option 6)

For additional information on the available options refer to Option Information.

Absolute Maximum Ratings

$T_{amb} = 25\text{ °C}$, unless otherwise specified

Stresses in excess of the absolute Maximum Ratings can cause permanent damage to the device. Functional operation of the device is not implied at these or any other conditions in excess of those given in the operational sections of this document. Exposure to absolute Maximum Rating for extended periods of the time can adversely affect reliability.

Input

Parameter	Test condition	Symbol	Value	Unit
Reverse voltage		V_R	6	V
Forward continuous current		I_F	20	mA
Surge forward current		I_{FSM}	1.5	A
Power dissipation	$t \leq 10\ \mu\text{s}$	P_{diss}	30	mW

Output

Parameter	Test condition	Part	Symbol	Value	Unit
Repetitive peak off-state voltage		BRT11	V_{DRM}	400	V
		BRT12	V_{DRM}	600	V
		BRT13	V_{DRM}	800	V
RMS on-state current			I_{TRMS}	300	mA
Single cycle surge current	50 Hz		I_{TSM}	3	A
Power dissipation			P_{diss}	600	mW

Coupler

Parameter	Test condition	Symbol	Value	Unit
Max. power dissipation		P_{tot}	630	mW
Ambient temperature		T_{amb}	- 40 to + 100	°C
Storage temperature		T_{stg}	- 40 to + 150	°C
Insulation test voltage ¹⁾ between input/output circuit (climate in acc. with DIN 40046, part 2, Nov. 74)		V_{ISO}	5300	V_{RMS}
Reference voltage in acc. with VDE 0110 b		V_{ref}	500	V_{RMS}
Reference voltage in acc. with VDE 0110 b (insulation group C)		V_{ref}	600	V_{DC}
Creepage resistance (in acc. with DIN IEC 112/VDE 0303, part 1)	(group IIIa acc. to DIN VDE 0109)	CTI	175	
Insulation resistance	$V_{IO} = 500\text{ V}, T_{amb} = 25\text{ °C}$	R_{IO}	$\geq 10^{12}$	Ω
	$V_{IO} = 500\text{ V}, T_{amb} = 100\text{ °C}$	R_{IO}	$\geq 10^{11}$	Ω
DIN humidity category, DIN 40 040			F	
Creepage distance (input/output circuit)			≥ 7.2	mm
Clearance (input/output circuit)			≥ 7.2	mm

¹⁾ Test AC voltage in acc. with DIN 57883, June 1980

Electrical Characteristics

$T_{amb} = 25\text{ }^{\circ}\text{C}$, unless otherwise specified

Minimum and maximum values are testing requirements. Typical values are characteristics of the device and are the result of engineering evaluation. Typical values are for information only and are not part of the testing requirements.

Input

Parameter	Test condition	Symbol	Min	Typ.	Max	Unit
Forward voltage	$I_F = 10\text{ mA}$	V_F		1.1	1.35	V
Reverse current	$V_R = 6\text{ V}$	I_R			10	μA
Thermal resistance ²⁾ junction - ambient		R_{thja}			750	$^{\circ}\text{C/W}$

²⁾ Static air, SITAC soldered in pcb or base plate.

Output

Parameter	Test condition	Symbol	Min	Typ.	Max	Unit
Critical rate of rise of off-state voltage	$V_D = 0.67 V_{DRM}, T_J = 25\text{ }^{\circ}\text{C}$	dV/dt_{cr}	10			$\text{kV}/\mu\text{s}$
	$V_D = 0.67 V_{DRM}, T_J = 80\text{ }^{\circ}\text{C}$	dV/dt_{cr}	5			$\text{kV}/\mu\text{s}$
Critical rate of rise of voltage at current commutation	$V_D = 0.67 V_{DRM}, T_J = 25\text{ }^{\circ}\text{C},$ $dI/dt_{crq} \leq 15\text{ A/ms}$	dV/dt_{crq}	10			$\text{kV}/\mu\text{s}$
	$V_D = 0.67 V_{DRM}, T_J = 80\text{ }^{\circ}\text{C},$ $dI/dt_{crq} \leq 15\text{ A/ms}$	dV/dt_{crq}	5			$\text{kV}/\mu\text{s}$
Critical rate of rise of on-state current		dI/dt_{cr}	8			$\text{A}/\mu\text{s}$
Pulse current	$t_p \leq 5\text{ }\mu\text{s}, f 0\text{ }100\text{ Hz},$ $dI_{tp}/dt \leq 8\text{ A}/\mu\text{s}$	I_{tp}			2	A
On-state voltage	$I_T = 300\text{ mA}$	V_T			2.3	V
Off-state current	$T_C = 80\text{ }^{\circ}\text{C}, V_{DRM}$	I_D		0.5	100	μA
Holding current	$V_D = 10\text{ V}$	I_H		80	500	μA
Thermal resistance ²⁾ junction - ambient	R_{thJA}	R_{thja}			125	$^{\circ}\text{C/W}$

²⁾ Static air, SITAC soldered in pcb or base plate.

Coupler

Parameter	Test condition	Symbol	Min	Typ.	Max	Unit
Trigger current	$V_D = 10\text{ V}, \text{F - Versions}$	I_{FT}			1.2	mA
	$V_D = 10\text{ V}, \text{H - Versions}$	I_{FT}	0.4		2	mA
	$V_D = 10\text{ V}, \text{M - Versions}$	I_{FT}	0.8		3	mA
Trigger current temperature gradient		$\Delta I_{FT}/\Delta T_j$		7	14	$\mu\text{A}/^{\circ}\text{C}$
Capacitance (input-output)	$V_R = 0\text{ V}, f = 1\text{ kHz}$	C_{IO}			2	pF

Typical Characteristics (Tamb = 25 °C unless otherwise specified)

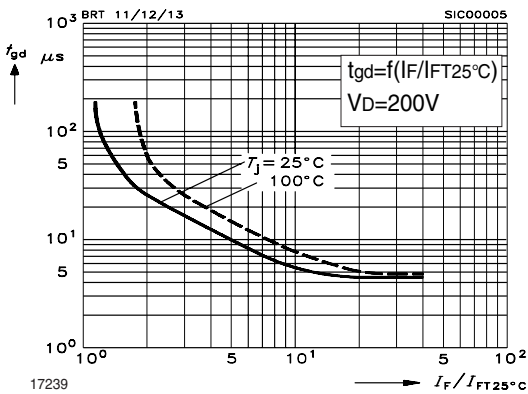

Figure 1. Typical Trigger Delay Time

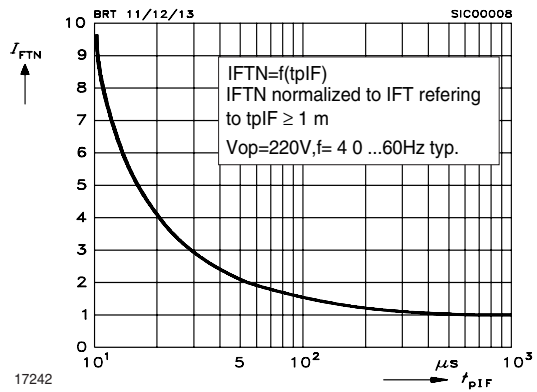

Figure 4. Pulse Trigger Current

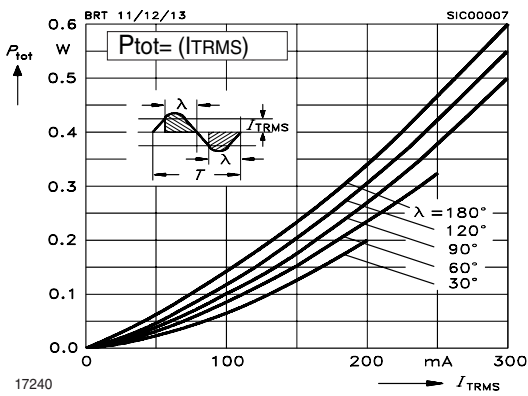

Figure 2. Power Dissipation 40 to 60 Hz Line Operation

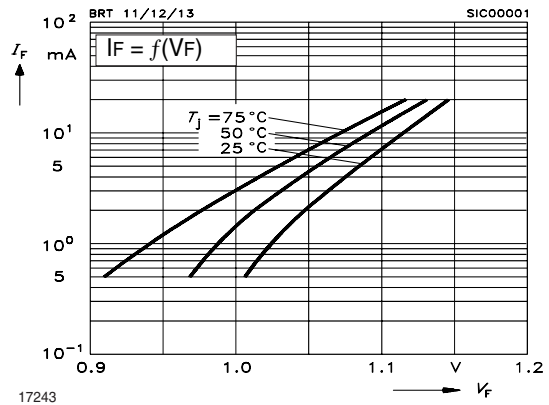

Figure 5. Typical Input Characteristics

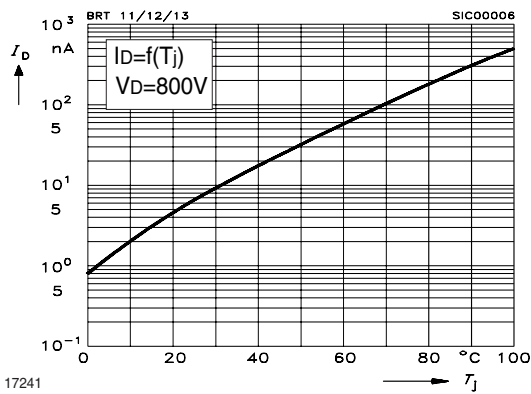

Figure 3. Typical Off-State Current

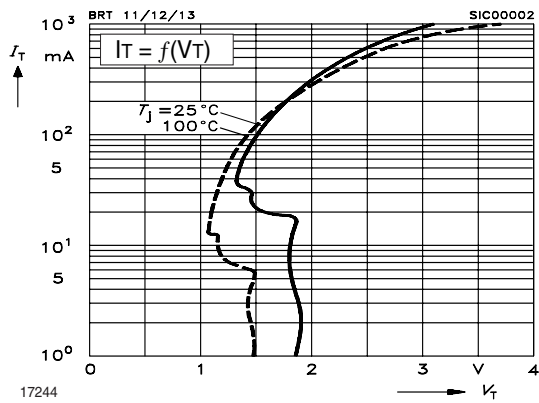

Figure 6. Typical Output Characteristics

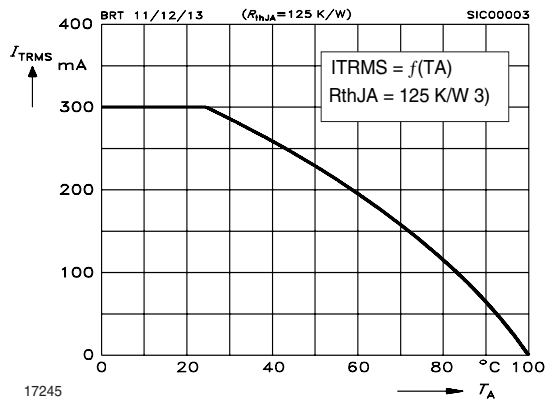

Figure 7. Current Reduction

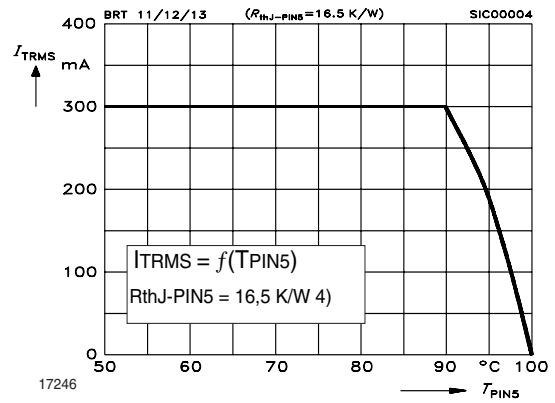
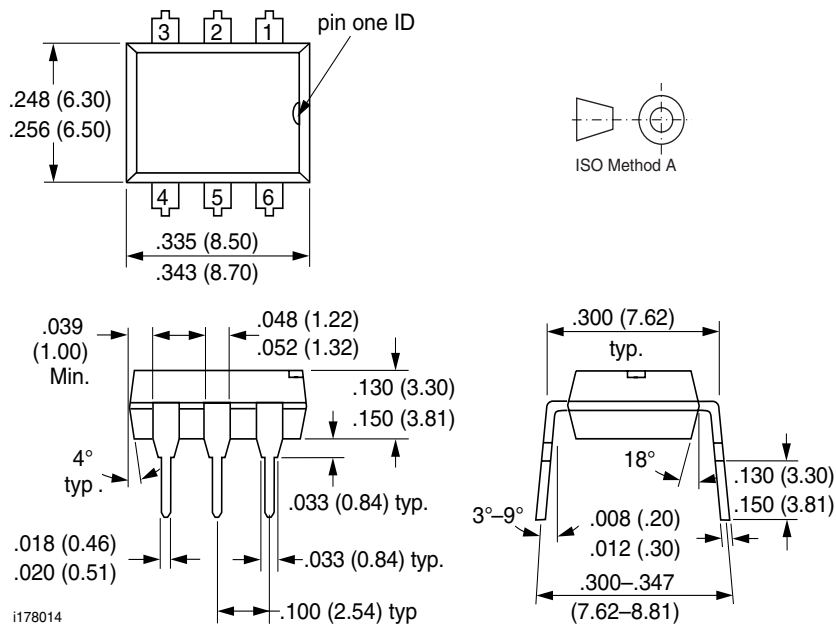
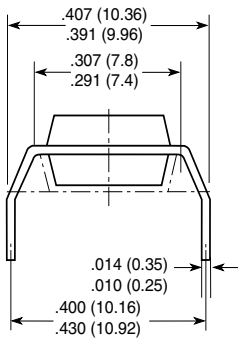

Figure 8. Current Reduction

Package Dimensions in Inches (mm)



Option 6



Option 7

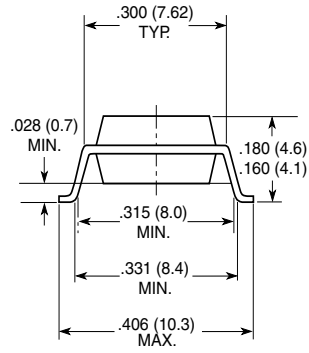

Option 9

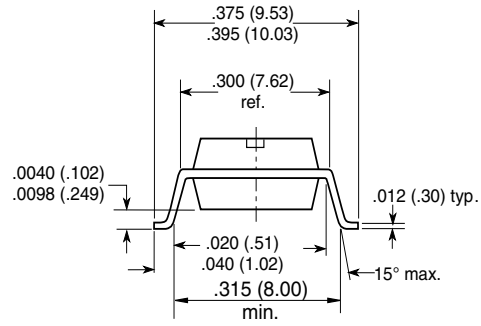

18450



Ozone Depleting Substances Policy Statement

It is the policy of Vishay Semiconductor GmbH to

1. Meet all present and future national and international statutory requirements.
2. Regularly and continuously improve the performance of our products, processes, distribution and operating systems with respect to their impact on the health and safety of our employees and the public, as well as their impact on the environment.

It is particular concern to control or eliminate releases of those substances into the atmosphere which are known as ozone depleting substances (ODSs).

The Montreal Protocol (1987) and its London Amendments (1990) intend to severely restrict the use of ODSs and forbid their use within the next ten years. Various national and international initiatives are pressing for an earlier ban on these substances.

Vishay Semiconductor GmbH has been able to use its policy of continuous improvements to eliminate the use of ODSs listed in the following documents.

1. Annex A, B and list of transitional substances of the Montreal Protocol and the London Amendments respectively
2. Class I and II ozone depleting substances in the Clean Air Act Amendments of 1990 by the Environmental Protection Agency (EPA) in the USA
3. Council Decision 88/540/EEC and 91/690/EEC Annex A, B and C (transitional substances) respectively.

Vishay Semiconductor GmbH can certify that our semiconductors are not manufactured with ozone depleting substances and do not contain such substances.

We reserve the right to make changes to improve technical design and may do so without further notice.

Parameters can vary in different applications. All operating parameters must be validated for each customer application by the customer. Should the buyer use Vishay Semiconductors products for any unintended or unauthorized application, the buyer shall indemnify Vishay Semiconductors against all claims, costs, damages, and expenses, arising out of, directly or indirectly, any claim of personal damage, injury or death associated with such unintended or unauthorized use.

Vishay Semiconductor GmbH, P.O.B. 3535, D-74025 Heilbronn, Germany



Disclaimer

All product specifications and data are subject to change without notice.

Vishay Intertechnology, Inc., its affiliates, agents, and employees, and all persons acting on its or their behalf (collectively, "Vishay"), disclaim any and all liability for any errors, inaccuracies or incompleteness contained herein or in any other disclosure relating to any product.

Vishay disclaims any and all liability arising out of the use or application of any product described herein or of any information provided herein to the maximum extent permitted by law. The product specifications do not expand or otherwise modify Vishay's terms and conditions of purchase, including but not limited to the warranty expressed therein, which apply to these products.

No license, express or implied, by estoppel or otherwise, to any intellectual property rights is granted by this document or by any conduct of Vishay.

The products shown herein are not designed for use in medical, life-saving, or life-sustaining applications unless otherwise expressly indicated. Customers using or selling Vishay products not expressly indicated for use in such applications do so entirely at their own risk and agree to fully indemnify Vishay for any damages arising or resulting from such use or sale. Please contact authorized Vishay personnel to obtain written terms and conditions regarding products designed for such applications.

Product names and markings noted herein may be trademarks of their respective owners.