

10 9 8 7 6 5 4 3 2 1

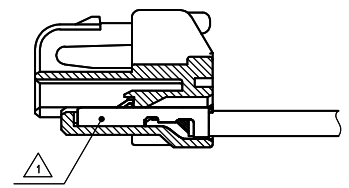

ターミナル装着図  
TERMINAL ASSEMBLY DRAWING

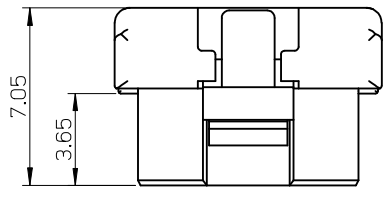
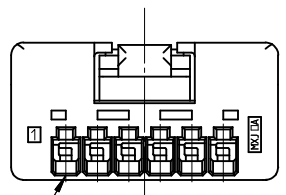
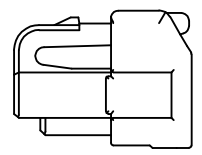
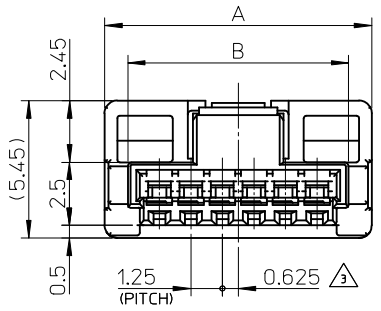

回路番号 1  
CKT NO. 1

NOTES

- ① 適合ターミナル: 502381-00\*\*  
APPLICABLE TARMINAL: 502381-00\*\*
- 2. 嵌合相手: 502382-\*\*09 / 502386-\*\*09  
MATE WITH: 502382-\*\*09 / 502386-\*\*09
- ③ 極数/コ=偶数に適用。  
APPLY FOR CKT. SIZE / 2 = EVEN.
- 4. 本製品のプラスチック部に黒点等が確認される場合や色合いが異なる場合がありますが、製品性能に影響はありません。  
THERE IS NO INFLUENCE IN THE PRODUCT PERFORMANCE THOUGH THE BLACK SPOT ETC. MIGHT BE CONFIRMED TO THE PLASTIC PART OF THIS PRODUCT AND THE SHADE MIGHT BE DIFFERENT.
- 5. アプリケーション仕様書 (コネクタ取扱説明書): AS-502380-001  
APPLICATION SPECIFICATIONS (CONNECTOR MANUAL): AS-502380-001
- 6. 製品仕様書: PS-502382-001  
Product specification: PS-502382-001

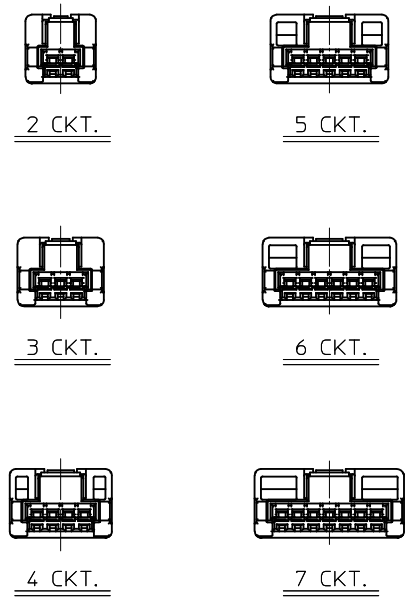

極数の種類 (正面図)  
KIND OF CKT. NO. (FRONT VIEW)

|      |       |   |                |
|------|-------|---|----------------|
| 10   | 11.85 | 502380-070*                                   | 7              |
| 8.75 | 10.6  | 502380-060*                                   | 6              |
| 7.5  | 9.35  | 502380-050*                                   | 5              |
| 6.25 | 8.1   | 502380-040*                                   | 4              |
| 5    | 6.85  | 502380-030*                                   | 3              |
| 3.75 | 5.6   | 502380-020*                                   | 2              |
| B    | A     | ポリ袋<br>POLYBAG PACKAGE<br>オーダー番号<br>ORDER No. | 極数<br>CKT. No. |

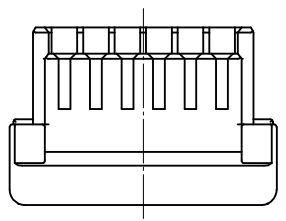

|  |                                       |   |                            |   |   |                        |
|--|---------------------------------------|---|----------------------------|---|---|------------------------|
| REVISED<br>EC NO: J2013-0870<br>DRWN: KWASHIO 2013/02/07<br>CHKD: KASAKAWA 2013/02/13<br>APPR: Y0 ITO 2013/02/13 | GENERAL TOLERANCES (UNLESS SPECIFIED) |   | DIMENSION STYLE<br>MM ONLY | SCALE<br>5:1  | DESIGN UNITS<br>METRIC                              | THIRD ANGLE PROJECTION |
|  | 10 UNDER                              | ±0.2  | DRAWN BY<br>T. MIYAZAKI    | DATE<br>2006/08/28  | TITLE<br>1.25 W/B CONN. SINGLE PLUG HOUSING 2-7CKT. |                        |
|  | 10 OVER 30 UNDER                      | ±0.25   | CHECKED BY<br>K. ASAKAWA   | DATE<br>2006/08/28  | MATERIAL NO.<br>SEE TABLE                           |                        |
|  | 30 OVER                               | ±0.3  | APPROVED BY<br>Y0. ITO     | DATE<br>2006/08/28  | DOCUMENT NO.<br>SD-502380-001                       | SHEET NO.<br>1 OF 2    |
| REV  | DESCRIPTION                           | ANGULAR ±3 °<br>DRAFT WHERE APPLICABLE<br>MUST REMAIN WITHIN DIMENSIONS | SIZE<br>A3                 | THIS DRAWING CONTAINS INFORMATION THAT IS PROPRIETARY TO MOLEX INCORPORATED AND SHOULD NOT BE USED WITHOUT WRITTEN PERMISSION |   |                        |

|                  |  |
|------------------|--|
| 部品<br>PART       | 材質<br>MATERIAL   |
| ハウジング<br>HOUSING | ポリブチレンテレフタレート UL94V-0 色: SHEET 2 参照<br>POLYBUTYLENE TEREPHTHALATE UL94V-0 COLOR: SEE SHEET 2 |

9 8 7 6 5 4 3 2

10 9 8 7 6 5 4 3 2 1

| HSG COLOR : GREEN                       | HSG COLOR : BLUE | HSG COLOR : RED | HSG COLOR : BLACK | HSG COLOR : NATURAL |              |
|---|------------------|-----------------|-------------------|---------------------|--------------|
| 502380-0706                             | 502380-0704      | 502380-0702     | 502380-0701       | 502380-0700         | 7            |
| 502380-0606                             | 502380-0604      | 502380-0602     | 502380-0601       | 502380-0600         | 6            |
| 502380-0506                             | 502380-0504      | 502380-0502     | 502380-0501       | 502380-0500         | 5            |
| 502380-0406                             | 502380-0404      | 502380-0402     | 502380-0401       | 502380-0400         | 4            |
| 502380-0306                             | 502380-0304      | 502380-0302     | 502380-0301       | 502380-0300         | 3            |
| 502380-0206                             | 502380-0204      | 502380-0202     | 502380-0201       | 502380-0200         | 2            |
| ホリ袋 POLYBAG PACKAGE<br>オーダー番号 ORDER No. |                  |                 |                   |                     | 極数 (KT. NO.) |

|   |                                       |   |                                   |                                      |   |                        |
|---|---------------------------------------|---|-----------------------------------|--------------------------------------|---|------------------------|
| REVISED<br>EC NO.: J2013-0870<br>DRWN: KWASHIO 2013/02/07<br>CHKD: KASAKAWA 2013/02/13<br>APPR: Y. ITO 2013/02/13 | GENERAL TOLERANCES (UNLESS SPECIFIED) |   | DIMENSION STYLE<br><b>MM ONLY</b> | SCALE<br>---                         | DESIGN UNITS<br><b>METRIC</b>   | THIRD ANGLE PROJECTION |
|   | 10 UNDER                              | ±0.2  | DRAWN BY<br>T. MIYAZAKI           | DATE<br>2006/08/28                   | TITLE<br>1.25 W/B CONN. SINGLE PLUG HOUSING 2-7CKT.                                   |                        |
|   | 10 OVER 30 UNDER                      | ±0.25   | CHECKED BY<br>K. ASAKAWA          | DATE<br>2006/08/28                   |  |                        |
|   | 30 OVER                               | ±0.3  | APPROVED BY<br>Y. ITO             | DATE<br>2006/08/28                   |   |                        |
| ANGULAR ±3 °  |                                       | MATERIAL NO.<br><b>SEE TABLE</b>  |                                   | DOCUMENT NO.<br><b>SD-502380-001</b> |   | SHEET NO.<br>2 OF 2    |
| DRAFT WHERE APPLICABLE MUST REMAIN WITHIN DIMENSIONS  |                                       | THIS DRAWING CONTAINS INFORMATION THAT IS PROPRIETARY TO MOLEX INCORPORATED AND SHOULD NOT BE USED WITHOUT WRITTEN PERMISSION |                                   |                                      |   |                        |

9 8 7 6 5 4 3 2

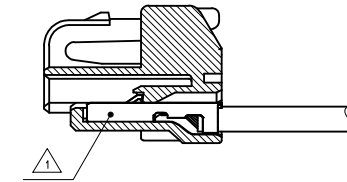
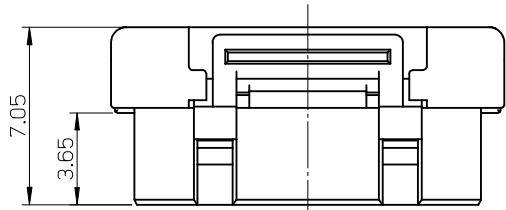

ターミナル装着図  
TERMINAL ASSEMBLY DRAWING

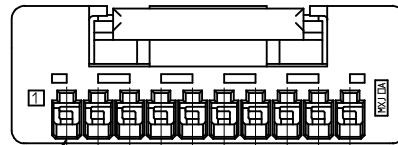
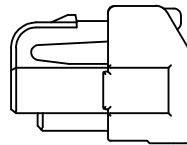
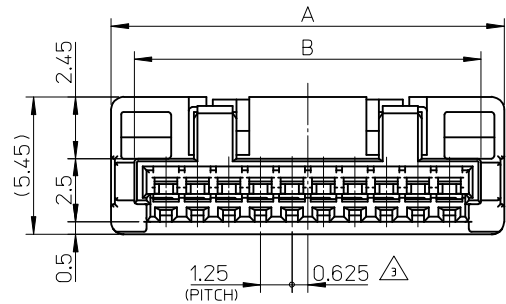

回路番号 1  
CKT NO. 1

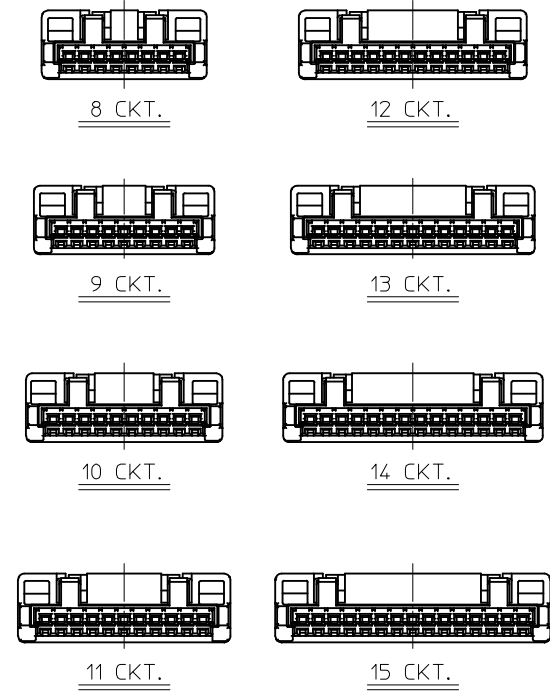
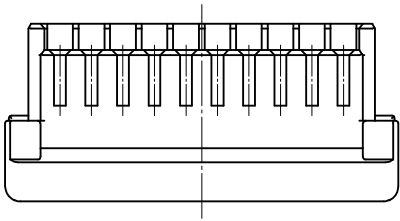

極数の種類 (正面図)  
KIND OF CKT. NO. (FRONT VIEW)

NOTES

- 適合ターミナル: 502381-00\*\*  
APPLICABLE TARMINAL : 502381-00\*\*
- 嵌合相手: 502382-\*\*09 / 502386-\*\*09  
MATE WITH : 502382-\*\*09 / 502386-\*\*09
- 極数/2=偶数に適用。  
APPLY FOR CKT. SIZE / 2 = EVEN.
- 本製品のプラスチック部に黒点等が確認される場合や色合いが異なる場合がありますが、製品性能に影響はありません。  
THERE IS NO INFLUENCE IN THE PRODUCT PERFORMANCE THOUGH THE BLACK SPOT ETC. MIGHT BE CONFIRMED TO THE PLASTIC PART OF THIS PRODUCT AND THE SHADE MIGHT BE DIFFERENT.
- アプリケーション仕様書 (コネクタ取扱説明書) : AS-502380-001  
APPLICATION SPECIFICATIONS (CONNECTOR MANUAL) : AS-502380-001.
- 製品仕様書 : PS-502382-001  
Product specification: PS-502382-001
- ELV AND RoHS COMPLIANT.

|       |       |   |                |
|-------|-------|---|----------------|
| 20    | 21.85 | 502380-150*                             | 15             |
| 18.75 | 20.6  | 502380-140*                             | 14             |
| 17.5  | 19.35 | 502380-130*                             | 13             |
| 16.25 | 18.1  | 502380-120*                             | 12             |
| 15    | 16.85 | 502380-110*                             | 11             |
| 13.75 | 15.6  | 502380-100*                             | 10             |
| 12.5  | 14.35 | 502380-090*                             | 9              |
| 11.25 | 13.1  | 502380-080*                             | 8              |
| B     | A     | ポリ袋 POLYBAG PACKAGE<br>オーダー番号 ORDER NO. | 極数<br>CKT. NO. |

|   |                    |  |       |                            |                               |  |                        |                        |  |
|---|--------------------|--|-------|----------------------------|-------------------------------|--|------------------------|------------------------|--|
| REVISED<br>EC NO: J2013-0870<br>DRWN:KASHIO 2013/02/17<br>CHKD:KASAKAWA 2013/02/13<br>APPR:Y0 ITO 2013/02/13                          | DESCRIPTION<br>REV | GENERAL TOLERANCES (UNLESS SPECIFIED)                |       | DIMENSION STYLE<br>MM ONLY |                               | SCALE<br>5:1   | DESIGN UNITS<br>METRIC | THIRD ANGLE PROJECTION |  |
|   |                    | 10 UNDER   | ±0.2  | DRAWN BY<br>T. MIYAZAKI    | DATE<br>2006/08/28            | TITLE<br>1.25 W/B CONN. SINGLE PLUG HOUSING 8-15CKT. |                        |                        |  |
|   |                    | 10 OVER 30 UNDER                                     | ±0.25 | CHECKED BY<br>K. ASAKAWA   | DATE<br>2006/08/28            |  |                        |                        |  |
|   |                    | 30 OVER  | ±0.3  | APPROVED BY<br>Y0. ITO     | DATE<br>2006/08/28            |  |                        |                        |  |
| ANGULAR ±3 °  |                    | DRAFT WHERE APPLICABLE MUST REMAIN WITHIN DIMENSIONS |       | MATERIAL NO.<br>SEE TABLE  | DOCUMENT NO.<br>SD-502380-002 |  | SHEET NO.<br>1 OF 2    |                        |  |
| SIZE A3 THIS DRAWING CONTAINS INFORMATION THAT IS PROPRIETARY TO MOLEX INCORPORATED AND SHOULD NOT BE USED WITHOUT WRITTEN PERMISSION |                    |  |       |                            |                               |  |                        |                        |  |

|                  |   |
|------------------|---|
| 部品<br>PART       | 材質<br>MATERIAL  |
| ハウジング<br>HOUSING | ポリブチレンテレフタレート UL94V-0 色: SHEET 2 参照<br>POLYBUTYLENE TEREPHTHALATE UL94V-0 COLOR : SEE SHEET 2 |

10 9 8 7 6 5 4 3 2 1

|   |              |
|---|--------------|
| HSG COLOR : ORANGE                      |              |
|   | 15           |
|   | 14           |
|   | 13           |
|   | 12           |
|   | 11           |
|   | 10           |
| 502380-0908                             | 9            |
|   | 8            |
| ポリ袋 POLYBAG PACKAGE<br>オーダー番号 ORDER No. | 極数 (KT. NO.) |

| HSG COLOR : GREEN                       | HSG COLOR : BLUE | HSG COLOR : YELLOW | HSG COLOR : RED | HSG COLOR : BLACK | HSG COLOR : NATURAL |              |
|---|------------------|--------------------|-----------------|-------------------|---------------------|--------------|
| 502380-1506                             | 502380-1504      |                    | 502380-1502     | 502380-1501       | 502380-1500         | 15           |
| 502380-1406                             | 502380-1404      |                    | 502380-1402     | 502380-1401       | 502380-1400         | 14           |
| 502380-1306                             | 502380-1304      |                    | 502380-1302     | 502380-1301       | 502380-1300         | 13           |
| 502380-1206                             | 502380-1204      |                    | 502380-1202     | 502380-1201       | 502380-1200         | 12           |
| 502380-1106                             | 502380-1104      |                    | 502380-1102     | 502380-1101       | 502380-1100         | 11           |
| 502380-1006                             | 502380-1004      |                    | 502380-1002     | 502380-1001       | 502380-1000         | 10           |
| 502380-0906                             | 502380-0904      | 502380-0903        | 502380-0902     | 502380-0901       | 502380-0900         | 9            |
| 502380-0806                             | 502380-0804      |                    | 502380-0802     | 502380-0801       | 502380-0800         | 8            |
| ポリ袋 POLYBAG PACKAGE<br>オーダー番号 ORDER No. |                  |                    |                 |                   |                     | 極数 (KT. NO.) |

|  |                                       |                                  |                                   |   |  |                        |
|--|---------------------------------------|----------------------------------|-----------------------------------|---|--|------------------------|
| REVISED<br>EC NO: J2013-0870<br>DRWN: KWASHIO 2013/02/07<br>CHKD: KASAKAWA 2013/02/13<br>APPR: Y. ITO 2013/02/13 | GENERAL TOLERANCES (UNLESS SPECIFIED) |                                  | DIMENSION STYLE<br><b>MM ONLY</b> | SCALE<br>----   | DESIGN UNITS<br><b>METRIC</b>                                  | THIRD ANGLE PROJECTION |
|  | 10 UNDER                              | ±0.2                             | DRAWN BY<br>T. MIYAZAKI           | DATE<br>2006/08/28  | TITLE<br>1.25 W/B CONN. SINGLE PLUG HOUSING 8-15CKT.           |                        |
|  | 10 OVER 30 UNDER                      | ±0.25                            | CHECKED BY<br>K. ASAKAWA          | DATE<br>2006/08/28  | <b>molex</b><br>DOCUMENT NO. SD-502380-002<br>SHEET NO. 2 OF 2 |                        |
|  | 30 OVER                               | ±0.3                             | APPROVED BY<br>Y. ITO             | DATE<br>2006/08/28  |  |                        |
| ANGULAR ±3 °   |                                       | MATERIAL NO.<br><b>SEE TABLE</b> |                                   | THIS DRAWING CONTAINS INFORMATION THAT IS PROPRIETARY TO MOLEX INCORPORATED AND SHOULD NOT BE USED WITHOUT WRITTEN PERMISSION |  |                        |
| DRAFT WHERE APPLICABLE MUST REMAIN WITHIN DIMENSIONS   |                                       |                                  |                                   |   |  |                        |

9 8 7 6 5 4 3 2