

**V53C104H
 ULTRA-HIGH PERFORMANCE,
 LOW POWER 256K X 4 BIT
 FAST PAGE MODE CMOS DYNAMIC RAM**

HIGH PERFORMANCE	45/45L	50/50L	55/55L	60/60L
Max. $\overline{\text{RAS}}$ Access Time, (t_{RAC})	45 ns	50 ns	55 ns	60 ns
Max. Column Address Access Time, (t_{CAA})	22 ns	24 ns	28 ns	30 ns
Min. Fast Page Mode Cycle Time, (t_{PC})	25 ns	28 ns	38 ns	40 ns
Min. Read/Write Cycle Time, (t_{RC})	90 ns	100 ns	110 ns	120 ns

LOW POWER V53C104HL	45L	50L	55L	60L
Max. CMOS Standby Current, (I_{DD6})	150 μA	150 μA	150 μA	150 μA

2
Features

- 256K x 4-bit organization
- $\overline{\text{RAS}}$ access time: 45,50,55,60 ns
- Low power dissipation
 - V53C104H-60
 - Operating Current – 85 mA max
 - TTL Standby Current – 2.0 mA max
- Low CMOS Standby Current
 - V53C104H – 1.0 mA max
 - V53C104HL – .15 mA max
- Low Battery Back-up Current
 - V53C104HL – 200 μA max
- Read-Modify-Write, $\overline{\text{RAS}}$ -Only Refresh, $\overline{\text{CAS}}$ -Before- $\overline{\text{RAS}}$ Refresh capability
- Refresh Interval
 - V53C104H – 512 cycles/8 ms
 - V53C104HL – 512 cycles/64 ms
- Fast Page Mode for a sustained data rate greater than 40 MHz
- Available in 20 pin Plastic DIP and 26/20 pin SOJ packages

cated with Mosel-Vitelic's VICMOS III technology, the V53C104H offers a combination of features: Fast Page Mode for high data bandwidth, fast usable speed, CMOS standby current and, on request, extended refresh for very low data retention power (V53C104HL).

All inputs and outputs are TTL compatible. Input and output capacitances are significantly lowered to allow increased system performance. Fast Page Mode operation allows random access of up to 512 (x4) bits within a row with cycle times as short as 25 ns. Because of static circuitry, the $\overline{\text{CAS}}$ clock is not in the critical timing path. The flow-through column address latches allow address pipelining while relaxing many critical system timing requirements for fast usable speed. These features make the V53C104H ideally suited for graphics, digital signal processing and high performance computing systems.

Description

The V53C104H is a high speed 262,144 x 4 bit CMOS dynamic random access memory. Fabri-

The V53C104HL offers a maximum data retention power of 1.1 mW when operating in CMOS standby mode and performing $\overline{\text{CAS}}$ -before- $\overline{\text{RAS}}$ refresh cycles. This mode is entered by holding $\overline{\text{RAS}}$ at a voltage greater than $V_{\text{DD}} - 0.2$ when it is inactive.

Device Usage Chart

Operating Temperature Range	Package Outline		Access Time (ns)				Power		Temperature Mark
	P	K	45	50	55	60	Low	Std.	
0°C to 70 °C	•	•	•	•	•	•	•	•	Blank

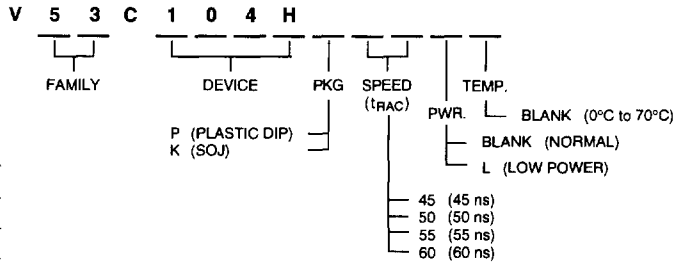

Description	Pkg.	Pin Count
Plastic DIP	P	20
SOJ	K	26/20

**26/20 Lead SOJ Package
PIN CONFIGURATION
Top View**

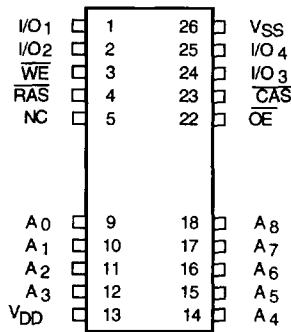

**20 Lead Plastic DIP
PIN CONFIGURATION
Top View**

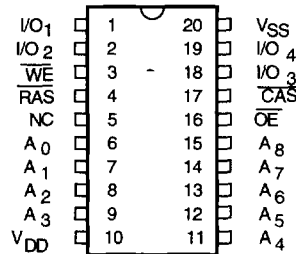

Pin Names

A ₀ -A ₈	Address Inputs
RAS	Row Address Strobe
CAS	Column Address Strobe
WE	Write Enable
OE	Output Enable
I/O ₁ -I/O ₄	Data Input, Output
V _{DD}	+5V Supply
V _{SS}	0V Supply
NC	No Connect

Absolute Maximum Ratings*

Ambient Temperature

Under Bias -10°C to +80°C
 Storage Temperature (plastic) -55°C to +125°C
 Voltage Relative to V_{SS} -1.0 V to +7.0 V
 Data Output Current 50 mA
 Power Dissipation 1.0 W

*Note: Operation above Absolute Maximum Ratings can adversely affect device reliability.

Capacitance*

T_A = 25°C, V_{DD} = 5 V ± 10%, V_{SS} = 0 V

Symbol	Parameter	Typ.	Max.	Unit
C _{IN1}	Address Input	3	4	pF
C _{IN2}	RAS, CAS, WE, OE	4	5	pF
C _{OUT}	Data Input/Output	5	7	pF

* Note: Capacitance is sampled and not 100% tested

Block Diagram

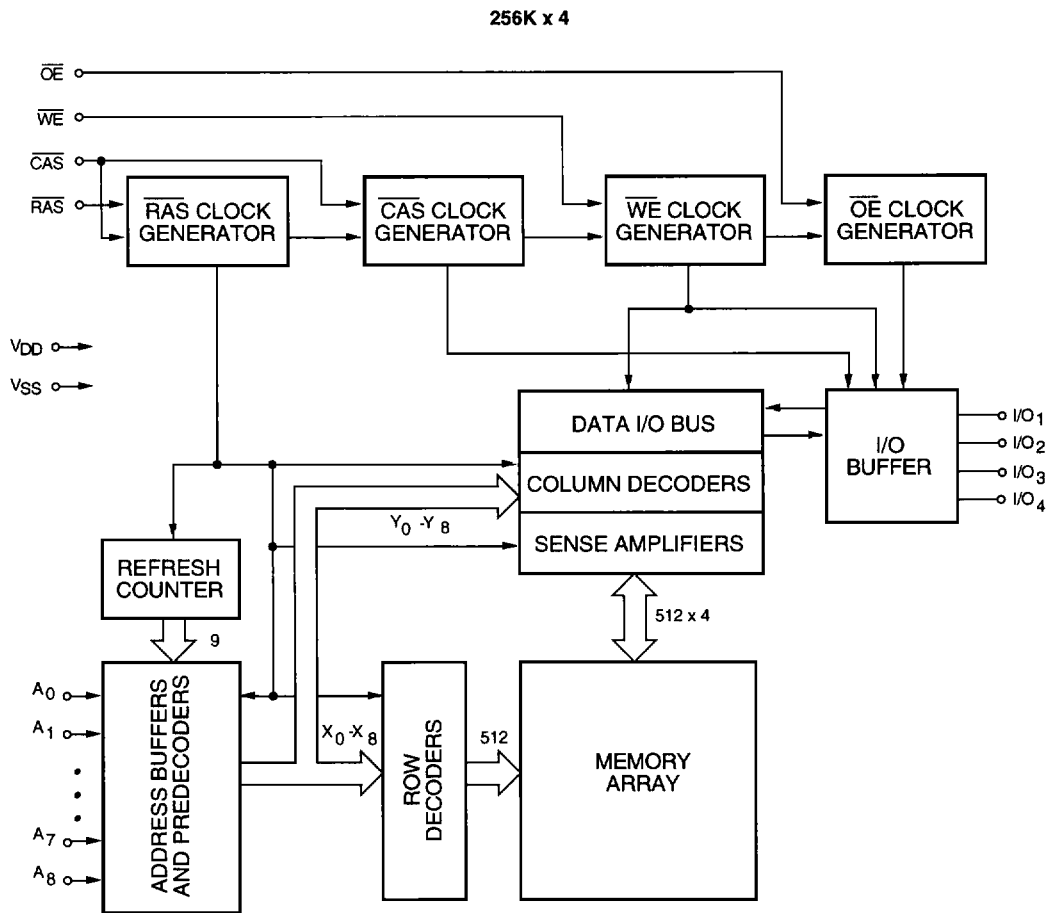

2

DC and Operating Characteristics (1-2)

$T_A = 0^\circ\text{C}$ to 70°C , $V_{DD} = 5\text{ V} \pm 10\%$, $V_{SS} = 0\text{ V}$, unless otherwise specified.

Symbol	Parameter	Access Time	V53C104H			V53C104HL			Unit	Test Conditions	Notes
			Min.	Typ.	Max.	Min.	Typ.	Max.			
I_{LI}	Input Leakage Current (any input pin)		-10		10	-10		10	μA	$V_{SS} \leq V_{IN} \leq V_{DD}$	
I_{LO}	Output Leakage Current (for High-Z State)		-10		10	-10		10	μA	$V_{SS} \leq V_{OUT} \leq V_{DD}$ $\overline{\text{RAS}}, \overline{\text{CAS}}$ at V_{IH}	
I_{DD1}	V_{DD} Supply Current, Operating	45			110			110	mA	$t_{RC} = t_{RC}(\text{min.})$	1, 2
		50			100			100			
		55			90			90			
		60			85			85			
I_{DD2}	V_{DD} Supply Current, TTL Standby				2			2	mA	$\overline{\text{RAS}}, \overline{\text{CAS}}$ at V_{IH} other inputs $\geq V_{SS}$	
I_{DD3}	V_{DD} Supply Current, $\overline{\text{RAS}}$ -Only Refresh	45			110			110	mA	$t_{RC} = t_{RC}(\text{min.})$	2
		50			100			100			
		55			90			90			
		60			85			85			
I_{DD4}	V_{DD} Supply Current, Fast Page Mode Operation	45			100			100	mA	Minimum Cycle	1, 2
		50			90			90			
		55			85			85			
		60			80			80			
I_{DD5}	V_{DD} Supply Current, Standby, Output Enabled				2.0			2.0	mA	$\overline{\text{RAS}} = V_{IH}$, $\overline{\text{CAS}} = V_{IL}$ other inputs $\geq V_{SS}$	1
I_{DD6}	V_{DD} Supply Current, CMOS Standby				1.0			0.15	mA	$\overline{\text{RAS}} \geq V_{DD} - 0.2\text{ V}$, $\overline{\text{CAS}} \geq V_{DD} - 0.2\text{ V}$, All other inputs $\geq V_{SS}$	
I_{DD7}	Battery Back-up Data Retention Current (V53C104HL Only)				N.A.			0.2	mA	$\overline{\text{CAS}}$ -before- $\overline{\text{RAS}}$ Refresh cycle $t_{RC} = 125\ \mu\text{s}$ CMOS clock levels	18
V_{IL}	Input Low Voltage		-1		0.8	-1		0.8	V		3
V_{IH}	Input High Voltage		2.4		$V_{DD}+1$	2.4		$V_{DD}+1$	V		3
V_{OL}	Output Low Voltage				0.4			0.4	V	$I_{OL} = 4.2\text{ mA}$	
V_{OH}	Output High Voltage		2.4			2.4			V	$I_{OH} = -5\text{ mA}$	

AC Characteristics

T_A = 0°C to 70°C, V_{DD} = 5 V ±10%, V_{SS} = 0V unless otherwise noted

AC Test conditions, input pulse levels 0 to 3V

#	JEDEC Symbol	Symbol	Parameter	45/L		50/L		55/L		60/L		Unit	Notes
				Min.	Max.	Min.	Max.	Min.	Max.	Min.	Max.		
1	t _{RL1RH1}	t _{RAS}	$\overline{\text{RAS}}$ Pulse Width	45	75K	50	75K	55	75K	60	75K	ns	
2	t _{RL2RL2}	t _{RC}	Read or Write Cycle Time	90		100		110		120		ns	
3	t _{RH2RL2}	t _{RP}	$\overline{\text{RAS}}$ Precharge Time	35		40		45		50		ns	
4	t _{RL1CH1}	t _{CSH}	$\overline{\text{CAS}}$ Hold Time	45		50		55		60		ns	
5	t _{CL1CH1}	t _{CAS}	$\overline{\text{CAS}}$ Pulse Width	12		12		15		15		ns	
6	t _{RL1CL1}	t _{RCD}	$\overline{\text{RAS}}$ to $\overline{\text{CAS}}$ Delay	18	31	19	36	20	40	20	45	ns	4
7	t _{WH2CL2}	t _{RCS}	Read Command Setup Time	0		0		0		0		ns	
8	t _{AVRL2}	t _{ASR}	Row Address Setup Time	0		0		0		0		ns	
9	t _{RL1AX}	t _{RAH}	Row Address Hold Time	8		9		10		10		ns	
10	t _{AVCL2}	t _{ASC}	Column Address Setup Time	0		0		0		0		ns	
11	t _{CL1AX}	t _{CAH}	Column Address Hold Time	6		7		10		10		ns	
12	t _{CL1RH1(R)}	t _{RSH (R)}	$\overline{\text{RAS}}$ Hold Time (Read Cycle)	14		14		15		15		ns	
13	t _{CH2RL2}	t _{CRP}	$\overline{\text{CAS}}$ to $\overline{\text{RAS}}$ Precharge Time	4		4		5		5		ns	
14	t _{CH2WX}	t _{RCH}	Read Command Hold Time Referenced to $\overline{\text{CAS}}$	0		0		0		0		ns	5
15	t _{RH2WX}	t _{RRH}	Read Command Hold Time Referenced to $\overline{\text{RAS}}$	0		0		0		0		ns	5
16	t _{OEL1RH2}	t _{ROH}	$\overline{\text{RAS}}$ Hold Time Referenced to $\overline{\text{OE}}$	9		9		10		10		ns	
17	t _{GL1QV}	t _{OAC}	Access Time from $\overline{\text{OE}}$		12		12		15		15	ns	
18	t _{CL1QV}	t _{CAC}	Access Time from $\overline{\text{CAS}}$		12		12		15		15	ns	6,7
19	t _{RL1QV}	t _{RAC}	Access Time from $\overline{\text{RAS}}$		45		50		55		60	ns	6,8,9
20	t _{AVQV}	t _{CAA}	Access Time from Column Address		22		24		28		30	ns	6,7, 10

AC Characteristics (Cont'd.)

#	JEDEC Symbol	Symbol	Parameter	45/L		50/L		55/L		60/L		Unit	Notes
				Min.	Max.	Min.	Max.	Min.	Max.	Min.	Max.		
21	t_{CL1QX}	t_{LZ}	\overline{OE} or \overline{CAS} to Low-Z Output	0		0		0		0		ns	16
22	t_{CH2OZ}	t_{HZ}	\overline{OE} or \overline{CAS} to High-Z Output	0	8	0	8	0	10	0	20	ns	16
23	t_{RL1AX}	t_{AR}	Column Address Hold Time from \overline{RAS}	30		35		45		50		ns	
24	t_{RL1AV}	t_{RAD}	\overline{RAS} to Column Address Delay Time	13	23	14	26	15	27	15	30	ns	11
25	$t_{CL1RH1(W)}$	$t_{RSH(W)}$	\overline{RAS} or \overline{CAS} Hold Time in Write Cycle	14		14		15		15		ns	
26	t_{WL1CH1}	t_{CWL}	Write Command to \overline{CAS} Lead Time	14		14		15		15		ns	
27	t_{WL1CL2}	t_{WCS}	Write Command Setup Time	0		0		0		0		ns	12,13
28	t_{CL1WH1}	t_{WCH}	Write Command Hold Time	6		7		10		10		ns	
29	t_{WL1WH1}	t_{WP}	Write Pulse Width	6		7		10		10		ns	
30	t_{RL1WH1}	t_{WCR}	Write Command Hold Time from \overline{RAS}	30		35		45		50		ns	
31	t_{WL1RH1}	t_{RWL}	Write Command to \overline{RAS} Lead Time	14		14		15		15		ns	
32	t_{DVWL2}	t_{DS}	Data in Setup Time	0		0		0		0		ns	14
33	t_{WL1DX}	t_{DH}	Data in Hold Time	6		7		10		10		ns	14
34	t_{WL1GL2}	t_{WOH}	Write to \overline{OE} Hold Time	9		9		10		10		ns	14
35	t_{GH2DX}	t_{OED}	\overline{OE} to Data Delay Time	8		8		10		10		ns	14
36	t_{RL2RL2} (RMW)	t_{RWC}	Read-Modify-Write Cycle Time	135		145		160		170		ns	
37	t_{RL1RH1} (RMW)	t_{RRW}	Read-Modify-Write Cycle \overline{RAS} Pulse Width	85		90		100		105		ns	
38	t_{CL1WL2}	t_{CWD}	\overline{CAS} to \overline{WE} Delay	31		33		38		40		ns	12

AC Characteristics (Cont'd.)

#	JEDEC Symbol	Symbol	Parameter	45/L		50/L		55/L		60/L		Unit	Notes
				Min.	Max.	Min.	Max.	Min.	Max.	Min.	Max.		
39	t_{RL1WL2}	t_{RWD}	\overline{RAS} to \overline{WE} Delay in Read-Modify-Write Cycle	65		70		80		85		ns	12
40	t_{CL1CH1}	t_{CRW}	\overline{CAS} Pulse Width (RMW)	50		54		62		65		ns	
41	t_{AVWL2}	t_{AWD}	Col. Address to \overline{WE} Delay	41		43		55		58		ns	12
42	t_{CL2CL2}	t_{PC}	Fast Page Mode Read or Write Cycle Time	25		28		38		40		ns	
43	t_{CH2CL2}	t_{CP}	\overline{CAS} Precharge Time	7		8		10		10		ns	
44	t_{AVRH1}	t_{CAR}	Column Address to \overline{RAS} Setup Time	22		24		28		30		ns	
45	t_{CH2QV}	t_{CAP}	Access Time from Column Precharge		24		26		32		34	ns	7
46	t_{RL1DX}	t_{DHR}	Data in Hold Time Referenced to \overline{RAS}	30		35		45		50		ns	
47	t_{CL1RL2}	t_{CSR}	\overline{CAS} Setup Time \overline{CAS} -before- \overline{RAS} Refresh	10		10		10		10		ns	
48	t_{RH2CL2}	t_{RPC}	\overline{RAS} to \overline{CAS} Precharge Time	0		0		0		0		ns	
49	t_{RL1CH1}	t_{CHR}	\overline{CAS} Hold Time \overline{CAS} -before- \overline{RAS} Refresh	12		12		15		15		ns	
50	t_{CL2CL2} (RMW)	t_{PCM}	Fast Page Mode Read-Modify-Write Cycle Time	65		70		82		85		ns	
	t_T	t_T	Transition Time (Rise and Fall)	3	50	3	50	3	50	3	50	ns	15
		t_{REF}	Refresh Interval (512 Cycles)		8		8		8		8	ms	17
		t_{REF}	Refresh Interval V53C104HL Only (512 Cycles, $t_{RC} = 125 \mu s$)		64		64		64		64	ms	17,18

2

Notes:

1. I_{DD} is dependent on output loading when the device output is selected. Specified I_{DD} (max.) is measured with the output open.
2. I_{DD} is dependent upon the number of address transitions. Specified I_{DD} (max.) is measured with a maximum of two transitions per address cycle in Fast Page Mode.
3. Specified V_{IL} (min.) is steady state operating. During transitions, V_{IL} (min.) may undershoot to -1.0 V for a period not to exceed 20 ns. All AC parameters are measured with V_{IL} (min.) $\geq V_{SS}$ and V_{IH} (max.) $\leq V_{DD}$.
4. t_{RCD} (max.) is specified for reference only. Operation within t_{RCD} (max.) limits insures that t_{RAC} (max.) and t_{CAA} (max.) can be met. If t_{RCD} is greater than the specified t_{RCD} (max.), the access time is controlled by t_{CAA} and t_{CAC} .
5. Either t_{RRH} or t_{RCH} must be satisfied for a Read Cycle to occur.
6. Measured with a load equivalent to two TTL inputs and 100 pF.
7. Access time is determined by the longest of t_{CAA} , t_{CAC} and t_{CAP} .
8. Assumes that $t_{RAD} \leq t_{RAD}$ (max.). If t_{RAD} is greater than t_{RAD} (max.), t_{RAC} will increase by the amount that t_{RAD} exceeds t_{RAD} (max.).
9. Assumes that $t_{RCD} \leq t_{RCD}$ (max.). If t_{RCD} is greater than t_{RCD} (max.), t_{RAC} will increase by the amount that t_{RCD} exceeds t_{RCD} (max.).
10. Assumes that $t_{RAD} \geq t_{RAD}$ (max.).
11. Operation within the t_{RAD} (max.) limit ensures that t_{RAC} (max.) can be met. t_{RAD} (max.) is specified as a reference point only. If t_{RAD} is greater than the specified t_{RAD} (max.) limit, the access time is controlled by t_{CAA} and t_{CAC} .
12. t_{WCS} , t_{RWD} , t_{AWD} and t_{CWD} are not restrictive operating parameters.
13. t_{WCS} (min.) must be satisfied in an Early Write Cycle.
14. t_{DS} and t_{DH} are referenced to the latter occurrence of \overline{CAS} or \overline{WE} .
15. t_T is measured between V_{IH} (min.) and V_{IL} (max.). AC-measurements assume $t_T = 5$ ns.
16. Assumes a three-state test load (5 pF and a 380 Ohm Thevenin equivalent).
17. An initial 200 μ s pause and 8 \overline{RAS} -containing cycles are required when exiting an extended period of bias without clocks. An extended period of time without clocks is defined as one that exceeds the specified Refresh Interval.
18. This is battery backup data retention mode under \overline{CAS} -before- \overline{RAS} refresh cycles.

$$t_{RC} = 125 \mu s \text{ (} 125 \mu s \times 512 = 64 \text{ ms)}$$

$$t_{RAS} = t_{RAS} \text{ (min.) to } 1 \mu s$$

$$\text{Input voltages: } \overline{RAS} \text{ and } \overline{CAS} \quad \begin{array}{l} V_{IH} > V_{DD} - 0.2 \text{ V} \\ V_{IL} < 0.2 \text{ V} \end{array}$$

$$\overline{WE} \text{ and } \overline{OE} \quad V_{IN} > V_{DD} - 0.2 \text{ V}$$

All other inputs at stable V_{IH} or V_{IL}

Waveforms of Read Cycle

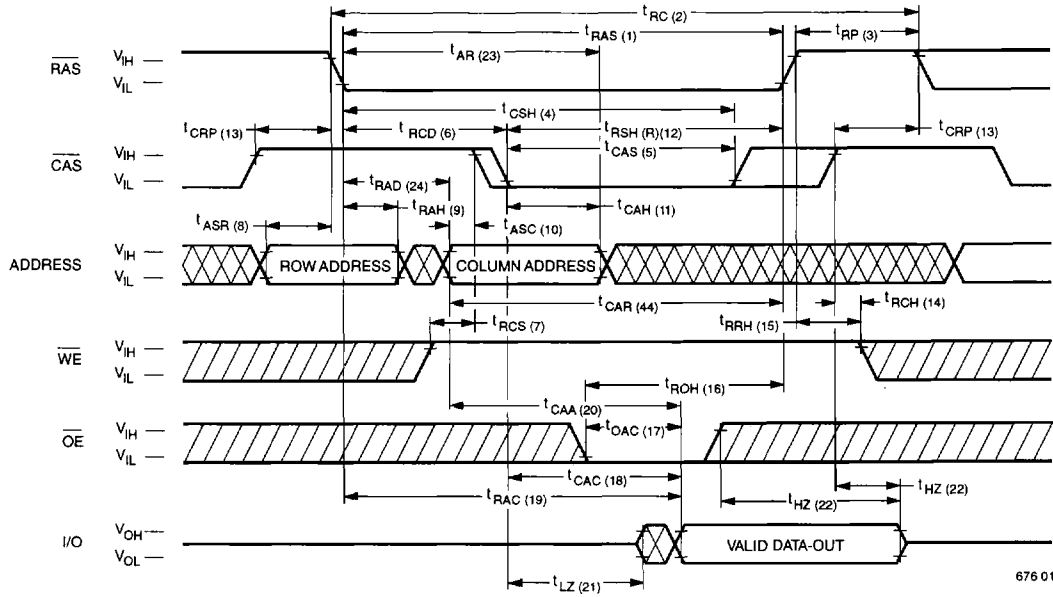

2

Waveforms of Early Write Cycle

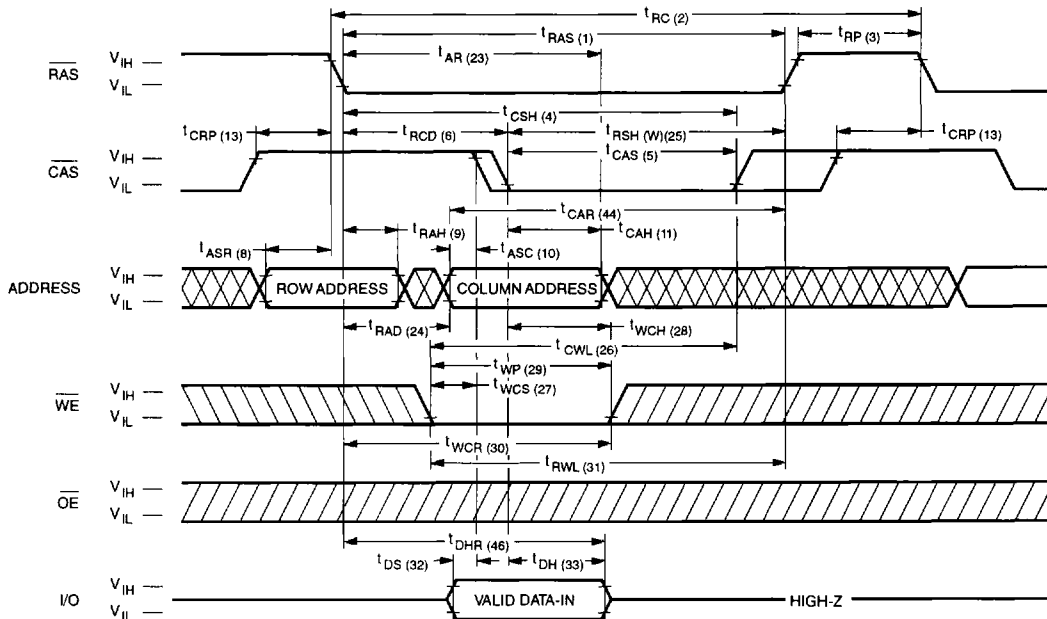

Waveforms of OE-Controlled Write Cycle

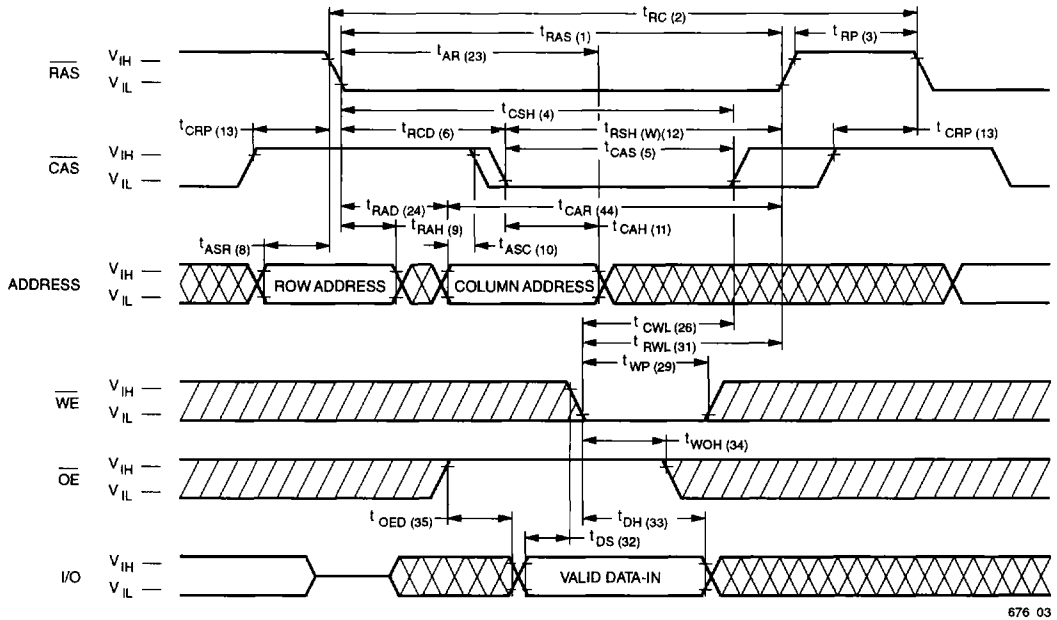

676 03

Waveforms of Read-Modify-Write Cycle

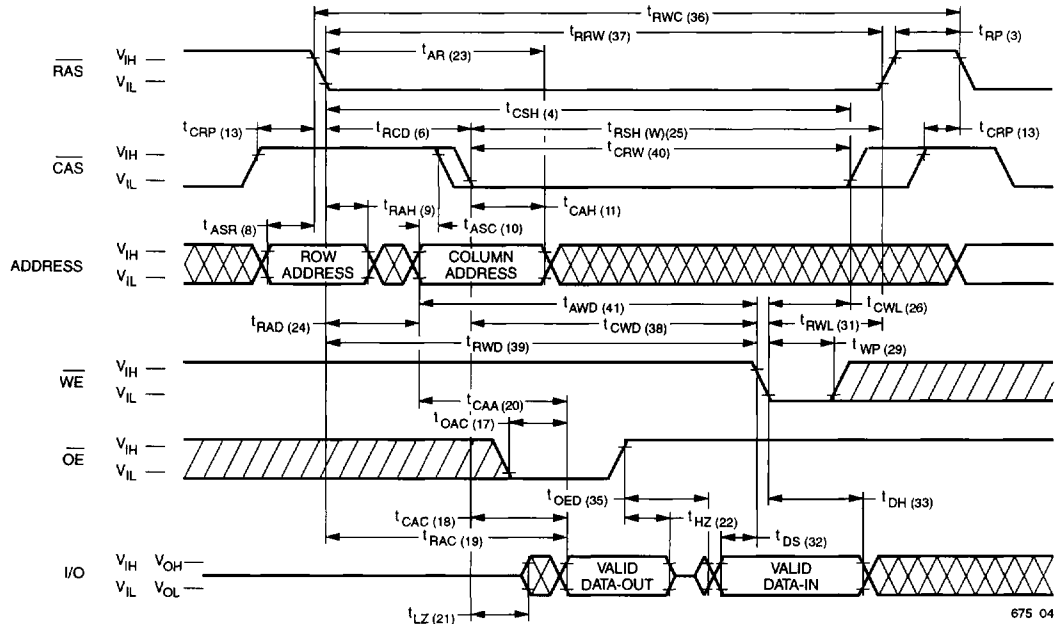

675 04

Waveforms of Fast Page Mode Read-Write Cycle

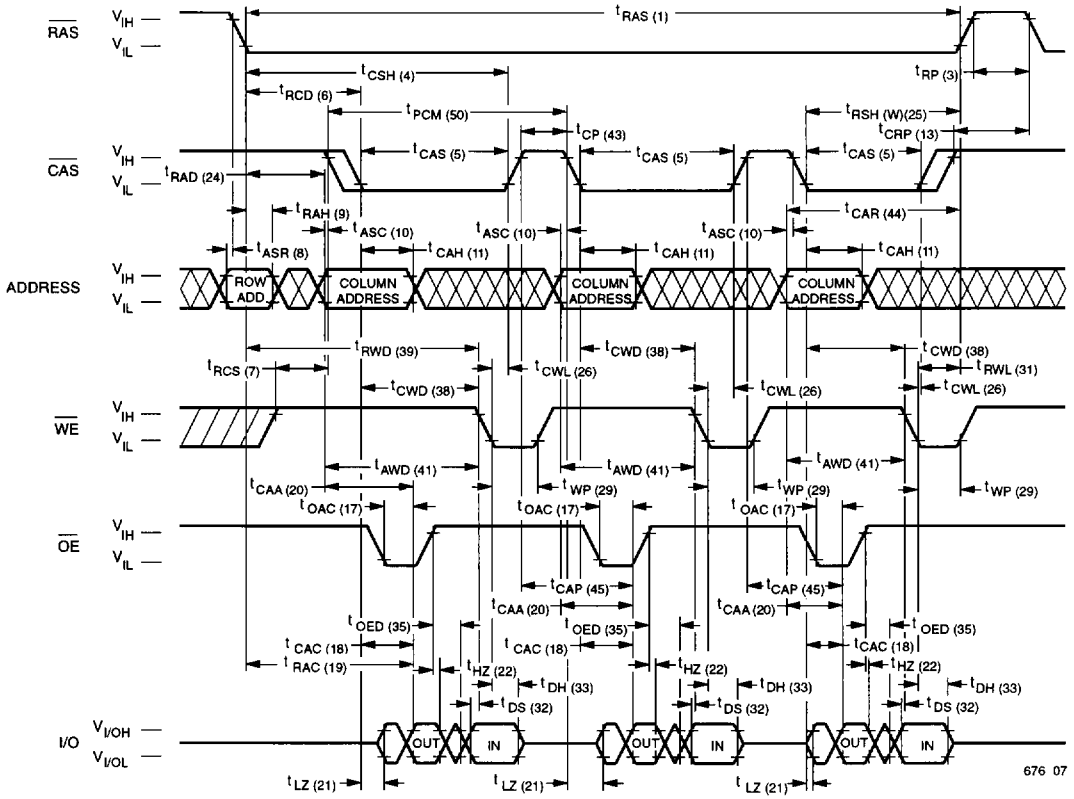

Waveforms of RAS-Only Refresh Cycle

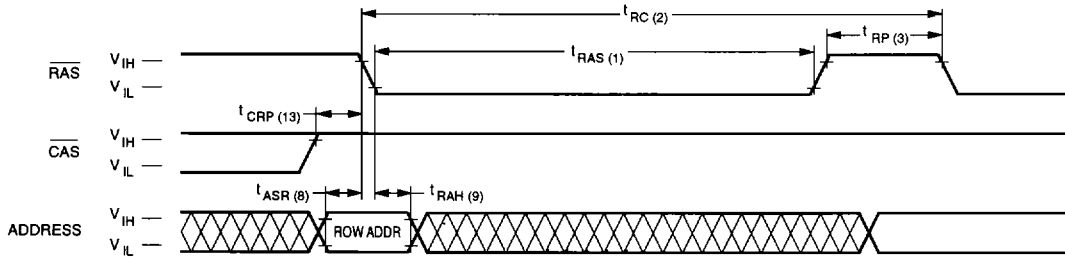

NOTE: \overline{WE} , \overline{OE} = Don't care

Waveforms of CAS-before-RAS Refresh Counter Test Cycle

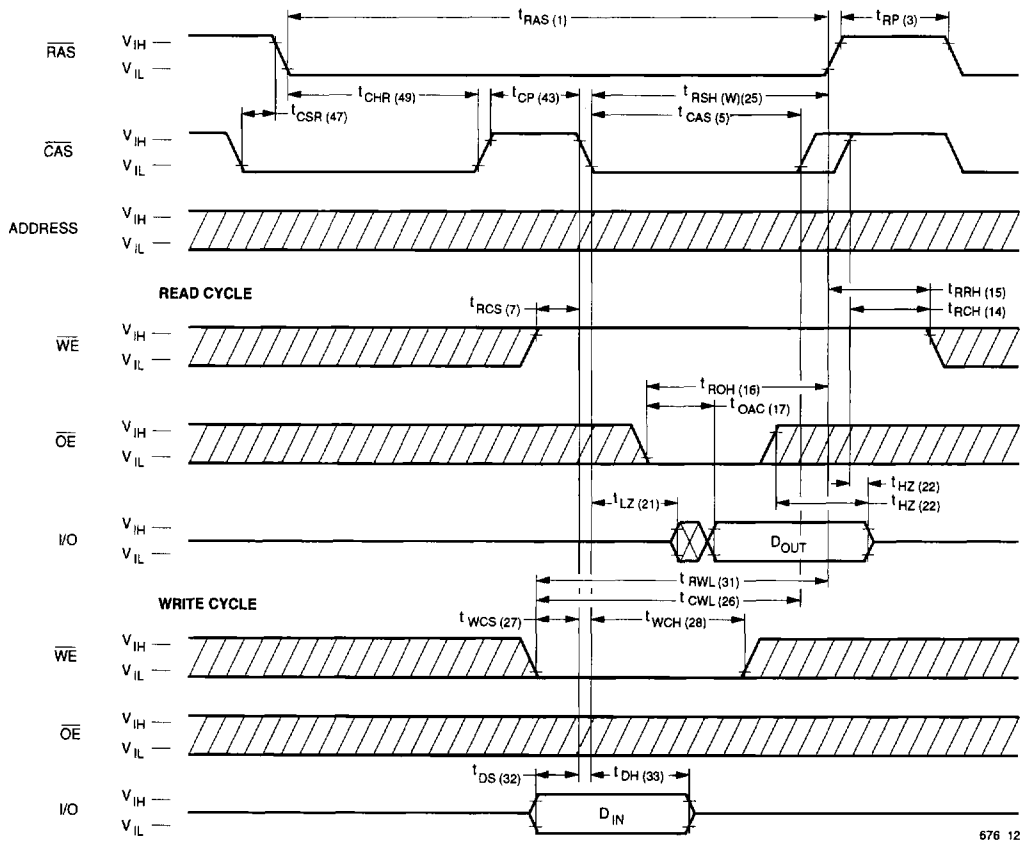

2

Waveforms of CAS-before-RAS Refresh Cycle

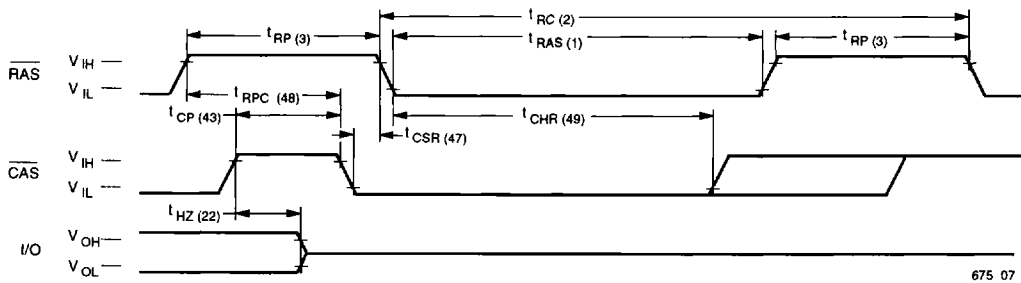

NOTE: $\overline{\text{WE}}, \overline{\text{OE}}, A_0-A_7$ = Don't care

Waveforms of Hidden Refresh Cycle (Read)

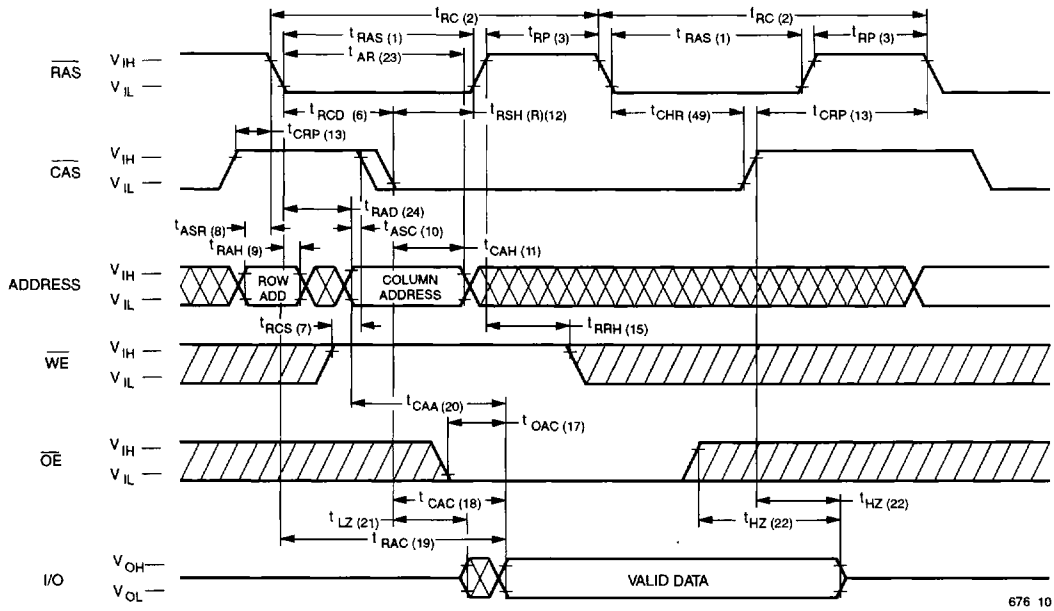

Waveforms of Hidden Refresh Cycle (Write)

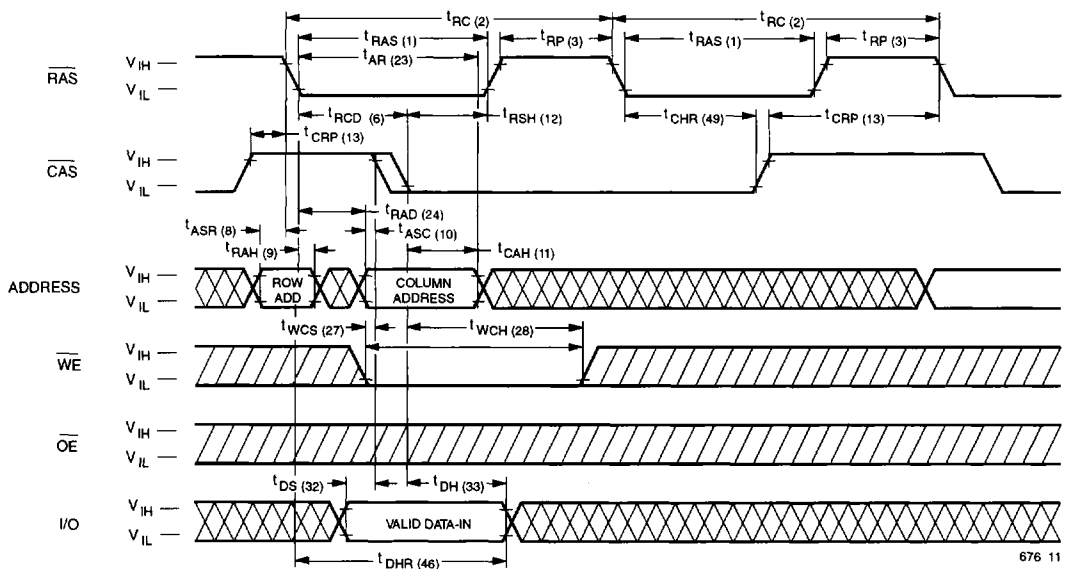

Functional Description

The V53C104H is a CMOS dynamic RAM optimized for high data bandwidth, low power applications. It is functionally similar to a traditional dynamic RAM. The V53C104H reads and writes data by multiplexing an 18-bit address into a 9-bit row and a 9-bit column address. The row address is latched by the Row Address Strobe (\overline{RAS}). The column address "flows through" an internal address buffer and is latched by the Column Address Strobe (\overline{CAS}). Because access time is primarily dependent on a valid column address rather than the precise time that the \overline{CAS} edge occurs, the delay time from \overline{RAS} to \overline{CAS} has little effect on the access time.

Memory Cycle

A memory cycle is initiated by bringing \overline{RAS} low. Any memory cycle, once initiated, must not be ended or aborted before the minimum t_{RAS} time has expired. This ensures proper device operation and data integrity. A new cycle must not be initiated until the minimum precharge time t_{RP}/t_{CP} has elapsed.

Read Cycle

A Read cycle is performed by holding the Write Enable (\overline{WE}) signal High during a $\overline{RAS}/\overline{CAS}$ operation. The column address must be held for a minimum specified by t_{AR} . Data Out becomes valid only when t_{OAC} , t_{RAC} , t_{CAA} and t_{CAC} are all satisfied. As a result, the access time is dependent on the timing relationships between these parameters. For example, the access time is limited by t_{CAA} when t_{RAC} , t_{CAC} and t_{OAC} are all satisfied.

Write Cycle

A Write Cycle is performed by taking \overline{WE} and \overline{CAS} low during a \overline{RAS} operation. The column address is latched by \overline{CAS} . The Write Cycle can be \overline{WE} controlled or \overline{CAS} controlled depending on whether \overline{WE} or \overline{CAS} falls later. Consequently, the input data must be valid at or before the falling edge of \overline{WE} or \overline{CAS} , whichever occurs last. In the \overline{CAS} -controlled Write Cycle, when the leading edge of \overline{WE} occurs prior to the \overline{CAS} low transition, the I/O data pins will be in the High-Z state at the beginning of the Write function.

Ending the Write with \overline{RAS} or \overline{CAS} will maintain the output in the High-Z state.

In the \overline{WE} controlled Write Cycle, \overline{OE} must be in the high state and t_{OED} must be satisfied.

Refresh Cycle

To retain data, 512 Refresh Cycles are required in each 8 ms period. There are two ways to refresh the memory:

1. By clocking each of the 512 row addresses (A_0 through A_9) with \overline{RAS} at least once every 8 ms. Any Read, Write, Read-Modify-Write or \overline{RAS} -only cycle refreshes the addressed row.
2. Using a \overline{CAS} -before- \overline{RAS} Refresh Cycle. If \overline{CAS} makes a transition from low to high to low after the previous cycle and before \overline{RAS} falls, \overline{CAS} -before- \overline{RAS} refresh is activated. The V53C104H uses the output of an internal 9-bit counter as the source of row addresses and ignore external address inputs.

\overline{CAS} -before- \overline{RAS} is a "refresh-only" mode and no data access or device selection is allowed. Thus, the output remains in the High-Z state during the cycle. A \overline{CAS} -before- \overline{RAS} counter test mode is provided to ensure reliable operation of the internal refresh counter.

Data Retention Mode

The V53C104H offers a CMOS standby mode that is entered by causing the \overline{RAS} clock to swing between a valid V_{IL} and an "extra high" V_{IH} within 0.2 V of V_{DD} . While the \overline{RAS} clock is at the "extra high" level, the V53C104H power consumption is reduced to the low I_{DD6} level. Overall I_{DD} consumption when operating in this mode can be calculated as follows:

$$I = \frac{(t_{RC}) \times (I_{DD1}) + (t_{RX} - t_{RC}) \times (I_{DD6})}{t_{RX}}$$

Where: t_{RC} = Refresh Cycle Time
 t_{RX} = Refresh Interval / 512

Fast Page Mode Operation

Fast Page Mode operation permits all 512 columns within a selected row of the device to be randomly accessed at a high data rate. Maintaining \overline{RAS} low while performing successive \overline{CAS} cycles retains the row address internally and eliminates the need to reapply it for each cycle. The column address buffer acts as a transparent or flow-through latch while \overline{CAS} is high. Thus, access begins from the occurrence of a valid column address rather than from the falling edge of \overline{CAS} , eliminating t_{ASC} and t_T from the critical timing path. \overline{CAS} latches the address into the column address buffer and acts as an output enable. During Fast Page Mode operation, Read, Write, Read-Modify-Write or Read-Write-Read cycles are possible at random addresses within a row. Following the initial entry cycle into Fast Page Mode, access is t_{CAA} or t_{CAP} controlled. If the column address is valid prior to the rising edge of \overline{CAS} , the access time is referenced to the \overline{CAS} rising edge and is specified by t_{CAP} . If the column address is valid after the rising \overline{CAS} edge, access is timed from the occurrence of a valid address and is specified by t_{CAA} . In both cases, the falling edge of \overline{CAS} latches the address and enables the output.

Fast Page Mode provides a sustained data rate of 40 MHz for applications that require high data rates such as bit-mapped graphics or high-speed signal processing. The following equation can be used to calculate the maximum data rate:

$$\text{Data Rate} = \frac{512}{t_{RC} + 511 \times t_{PC}}$$

Data Output Operation

The V53C104H Input/Output is controlled by \overline{OE} , \overline{CAS} , \overline{WE} and \overline{RAS} . A \overline{RAS} low transition enables the transfer of data to and from the selected row address in the Memory Array. A \overline{RAS} high transition disables data transfer and latches the output data if the output is enabled. After a memory cycle is initiated with a \overline{RAS} low transition, a \overline{CAS} low transition or \overline{CAS} low level enables the internal I/O path. A \overline{CAS} high transition or a \overline{CAS} high level disables the I/O path and the output driver if it is enabled. A \overline{CAS} low transition while \overline{RAS} is high has no effect on the I/O data path or on the output drivers. The output drivers, when otherwise enabled, can be disabled by holding

\overline{OE} high. The \overline{OE} signal has no effect on any data stored in the output latches. A \overline{WE} low level can also disable the output drivers when \overline{CAS} is low. During a Write cycle, if \overline{WE} goes low at a time in relationship to \overline{CAS} that would normally cause the outputs to be active, it is necessary to use \overline{OE} to disable the output drivers prior to the \overline{WE} low transition to allow Data In Setup Time (t_{DS}) to be satisfied.

Power-On

After application of the V_{DD} supply, an initial pause of 200 μs is required followed by a minimum of 8 initialization cycles (any combination of cycles containing a \overline{RAS} clock). Eight initialization cycles are required after extended periods of bias without clocks (greater than the Refresh Interval).

During Power-On, the V_{DD} current requirement of the V53C104H is dependent on the input levels of \overline{RAS} and \overline{CAS} . If \overline{RAS} is low during Power-On, the device will go into an active cycle and I_{DD} will exhibit current transients. It is recommended that \overline{RAS} and \overline{CAS} track with V_{DD} or be held at a valid V_{IH} during Power-On to avoid current surges.

Table 1. V53C104H Data Output Operation for Various Cycle Types

Cycle Type	I/O State
Read Cycles	Data from Addressed Memory Cell
\overline{CAS} -Controlled Write Cycle (Early Write)	High-Z
\overline{WE} -Controlled Write Cycle (Late Write)	\overline{OE} Controlled. High \overline{OE} = High-Z I/Os
Read-Modify-Write Cycles	Data from Addressed Memory Cell
Fast Page Mode Read	Data from Addressed Memory Cell
Fast Page Mode Write Cycle (Early Write)	High-Z
Fast Page Mode Read-Modify-Write Cycle	Data from Addressed Memory Cell
\overline{RAS} -only Refresh	High-Z
\overline{CAS} -before- \overline{RAS} Refresh Cycle	Data remains as in previous cycle
\overline{CAS} -only Cycles	High-Z

V53C104H Rev. 1.0 January 1995