

Surface
SMT
Mount

2mm FLEX SHROUD HEADER

SPECIFICATIONS

For complete specifications and recommended PCB layouts see www.samtec.com/TMMH

Insulator Material: Black Liquid Crystal Polymer
Terminal Material: Phosphor Bronze
Plating: Sn or Au over 50µ" (1,27µm) Ni
Operating Temp Range: -55°C to +105°C with Tin; -55°C to +125°C with Gold
Voltage Rating: 500 VAC mated with SQW
RoHS Compliant: Yes



Processing:
Max Processing Temp: 230°C for 60 seconds, or 260°C for 20 seconds 3x
Lead-Free Solderable: Yes
SMT Lead Coplanarity: (0,10mm) .004" max

Mates with: CLT, SQT, SQW, ESQT, TLE, SMM, MMS, TCSD

OPTIONS

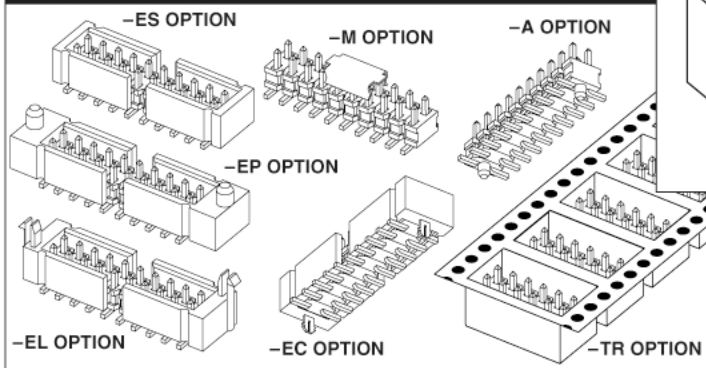

FLEX SHROUD

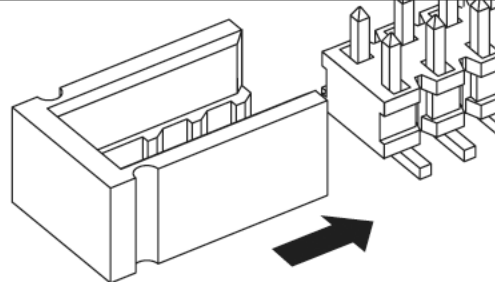

ALSO AVAILABLE

Through-Hole



2mm Shunt

Specify 2SN-BK-G for 2mm shunt with Gold plating.

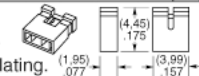

CURRENT RATING		
AMBIENT TEMP	Mated with	
	SQT	CLT
20°C	5.5A	3.7A
40°C	5A	3.3A
60°C	4A	2.9A
80°C	3A	2.4A

TMMH

1

NO. PINS PER ROW

LEAD STYLE

PLATING OPTION

03 thru 50

Specify LEAD STYLE from chart

-F
= Gold flash on post, Matte Tin on tail

-L
= 10µ" (0,25µm) Gold on post, Matte Tin on tail

-G
= 20µ" (0,51µm) Gold on post Gold flash on tail

-T
= Matte Tin

-S
= 30µ" (0,76µm) Gold on post, Matte Tin on tail

OPTION	Z
-ES	(2,92) .115
-EC	(4,70) .185
-EP & -EPC	(6,10) .240
-EL & -EBC	(4,45) .175

LEAD STYLE	A	MATES WITH
-01	(3,20) .126	SQT, SQW, ESQT, TLE, SMM, MMS, TCSD
-04	(1,91) .075	
-05	(1,65) .065	CLT

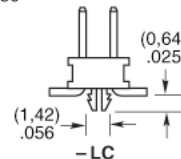
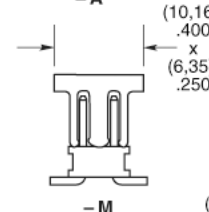
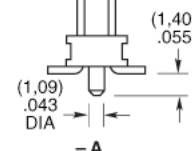
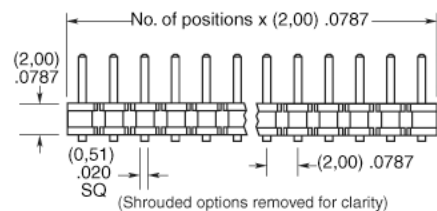
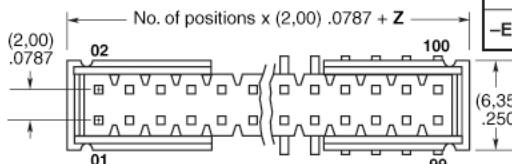

Note: Some lengths, styles and options are non-standard, non-returnable.

Due to technical progress, all designs, specifications and components are subject to change without notice.

WWW.SAMTEC.COM

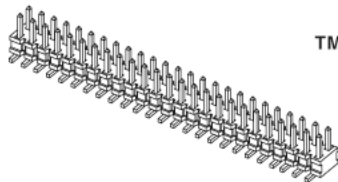

TMMH-125-01-S-DV

TMMH-110-01-T-DV-A

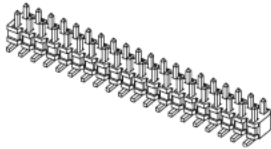
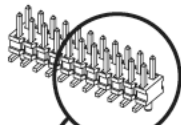

TMMH-120-04-T-DV

TMMH-116-04-G-DV-EL

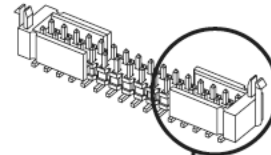

TMMH-110-04-G-DV

TMMH SERIES

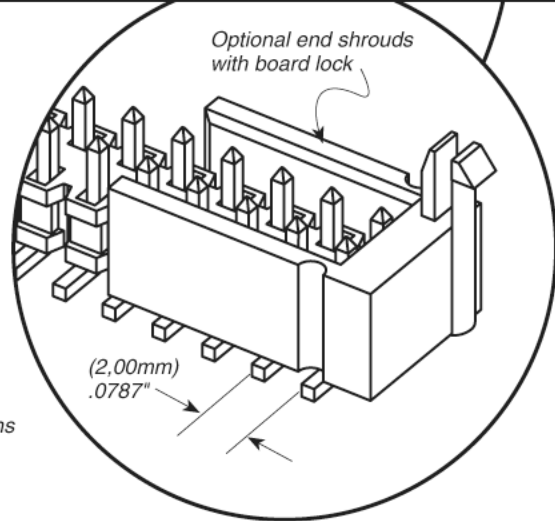
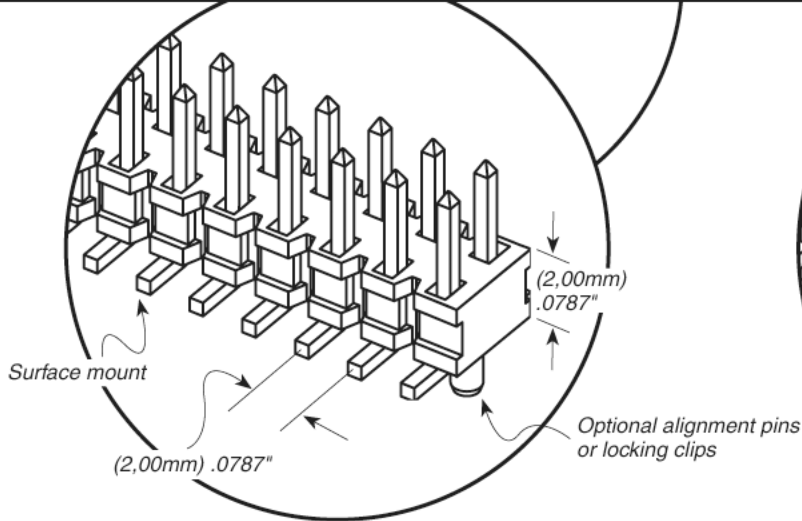

DV

FLEX SHROUD OPTIONS

OTHER OPTIONS

All Flex Shroud options require 9 pins/row minimum
(For board-to-board interfaces. Will not mate with TCSD)

-ES

= End Shroud
(For best cost also see TSH Series)

-EC

= End Shroud with Locking Clip
(For best cost also see TSH Series)

-EP

= End Shroud with Guide Post

-EL

= End Shroud with Board Lock
(Boards are positively locked and cannot be unmated)

-EBC

= End Shroud with Board Lock and Locking Clip
(Boards are positively locked and cannot be unmated)

-EPC

= End Shroud with Guide Post and Locking Clip

-“XXX”

= Polarized Position
Specify position of omitted pin

-A

= Alignment Pin
(3 positions minimum)

-LC

= Locking Clip
(10 positions minimum)

-M

= Pick & Place Pad
(5 positions minimum)

-TR

= Tape & Reel Packaging
(Flex Shroud options not available except -ES, -EP & -EL)

LEAD STYLE	X	Y
-01	(5,84) .230	(4,45) .175
-04 & -05	(4,50) .177	(3,02) .119

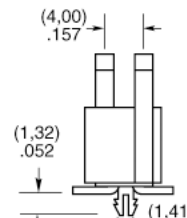
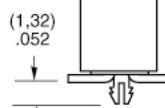
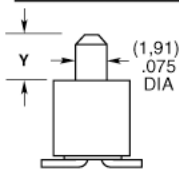
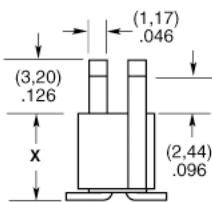
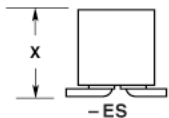

TAPE & REEL AVAILABILITY

No tooling charges.
125 piece minimum order.
Order any quantity above minimum.
In-house design, manufacture.
Quick turn-around.

Call Samtec for specifications and ordering information.

Due to technical progress, all designs, specifications and components are subject to change without notice.

WWW.SAMTEC.COM

SAMTEC USA • Tel: 1-800-SAMTEC-9 or 812-944-6733 • Fax: 812-948-5047
 SAMTEC GERMANY • Tel: +49 (0) 89 / 89460-0 • Fax: +49 (0) 89 / 89460-299
 SAMTEC ASIA PACIFIC • Tel: 65 6745-5955 • Fax: 65 6841-1502
 SAMTEC HONG KONG • Tel: 852-26904858 • Fax: 852-26904842
 SAMTEC SILICON VALLEY • Tel: 408-395-5900 • Fax: 408-395-1520
 SAMTEC FRANCE • Tel: 01 60 95 06 60 • Fax: 01 60 95 06 61
 SAMTEC JAPAN • Tel: 045-475-1385 • Fax: 045-475-1340
 SAMTEC KOREA • Tel: 82-31-717-5685 • Fax: 82-31-717-5681
 SAMTEC ISRAEL • Tel: 972-3-7526600 • Fax: 972-3-7526690
 SAMTEC CHINA • Tel: 86-21-61103766 • Fax: 86-21-61103766
 SAMTEC SOUTH AFRICA • Tel: 27 11 4528112 • Fax: 27 86 6714432
 SAMTEC UK • Tel: 01236 739292 • Fax: 01236 727113
 SAMTEC ITALY • Tel: 39 039 6890337 • Fax: 39 039 6890315
 SAMTEC INDIA • Tel: +91-80-3272 1612 • Fax: +91-80-4152 8187
 SAMTEC TAIWAN • Tel: 886 02 2698-3367 • Fax: 886 02 8698-2159
 SAMTEC ANZ • Tel: 613 9512 7747 • Fax: 613 9512 7745