

24-30GHz Integrated Down Converter

GaAs Monolithic Microwave IC

Description

The CHR2295 is a multifunction chip which integrates a LO time two multiplier, a balanced cold FET mixer, and a RF LNA. It is designed for a wide range of applications, typically commercial communication systems. The backside of the chip is both RF and DC grounds. This helps simplify the assembly process.

The circuit is manufactured with a pHEMT process, 0.25 μ m gate length, via holes through the substrate, air bridges and electron beam gate lithography. It is available in chip form.

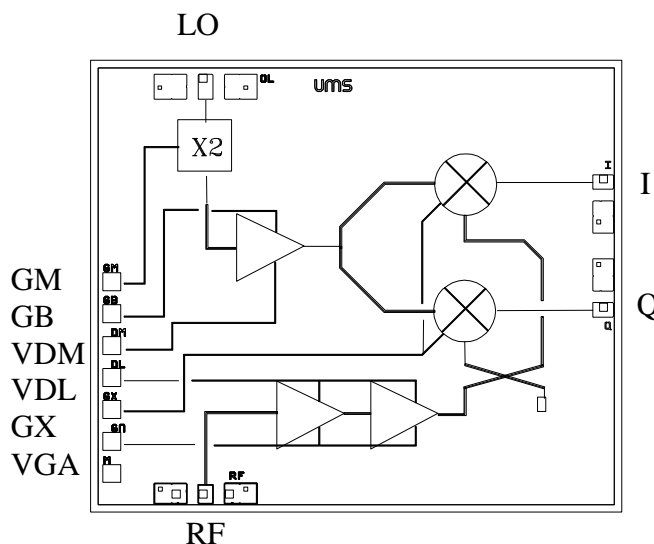

Main Features

- Broadband performances: 24-30GHz
- 11dB conversion gain
- 3.5dB noise figure, for IF>0.1GHz
- 10dBm LO input power
- -10dBm RF IP@1dB gain comp.
- Low DC power: 120mA@3.5V
- Chip size: 2.49x1.97x0.10mm

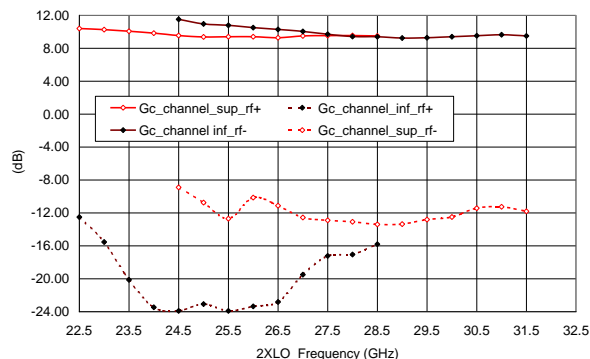

Conversion Gain & Image suppression
@IF=1.5GHz (test board losses included)

Main Characteristics

Tamb. = 25°C

Symbol	Parameter	Min	Typ	Max	Unit
F_{RF}	RF frequency range	24		30	GHz
F_{LO}	LO frequency range	12		15	GHz
F_{IF}	IF frequency range	DC		1.5	GHz
G_c	Conversion gain	8.5	11		dB

ESD Protection: Electrostatic discharge sensitive device. Observe handling precautions!

Electrical Characteristics for Broadband Operation

Tamb = +25°C, Vd = 3.5V

Symbol	Parameter	Min	Typ	Max	Unit
F _{RF}	RF frequency range	24		30	GHz
F _{LO}	LO frequency range	12		15	GHz
F _{IF}	IF frequency range	DC		1.5	GHz
G _c	Conversion gain ⁽¹⁾	8.5	11		dB
NF	Noise Figure, for IF>0.1GHz		3.5		dB
P _{LO}	LO Input power		10		dBm
Img Sup	Image Suppression	15	17		dBc
P1dB	Input power at 1dB gain compression		-10		dBm
LO VSWR	Input LO VSWR ⁽¹⁾		2.0:1		
RF VSWR	Input RF VSWR ⁽¹⁾		3.0:1		
I _d	Bias current ⁽²⁾		120		mA

(1) On Wafer measurements

(2) Current source biasing network is recommended. Optimum performances will be achieved for I_{dm}=50mA and I_{dl}=70mA

Absolute Maximum Ratings

Tamb. = 25°C ⁽¹⁾

Symbol	Parameter	Values	Unit
V _d	Drain bias voltage	4.0	V
I _d	Drain bias current	200	mA
V _g	Gate bias voltage	-2.0 to +0.4	V
P _{in}	Maximum peak input power overdrive ⁽²⁾	+15	dBm
T _a	Operating temperature range	-40 to +85	°C
T _{stg}	Storage temperature range	-55 to +155	°C

(1) Operation of this device above anyone of these parameters may cause permanent damage.

(2) Duration < 1s.

Typical On-wafer Measurements

Bias Conditions : $V_{dm} = V_{dl} = 3.5V$, $V_{gm} = -0.9V$, $V_{gb} = -0.3V$, $V_{gx} = -0.7V$, $V_{ga} = -0.2V$

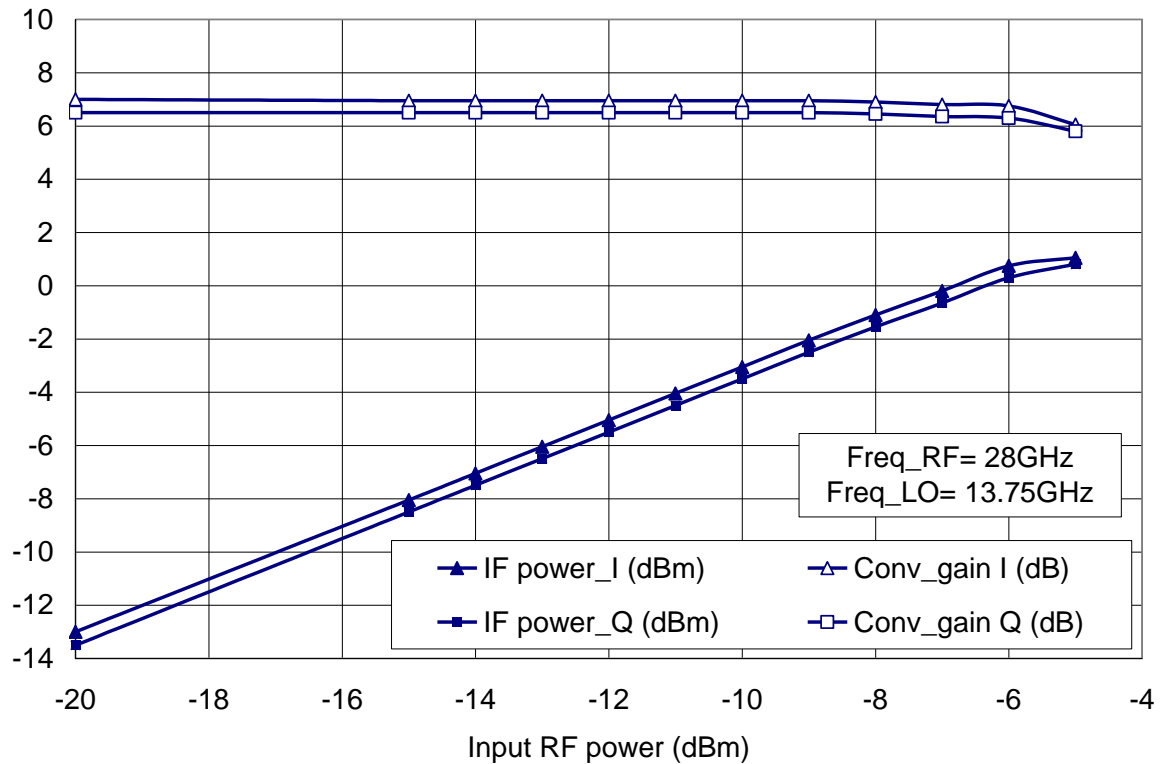
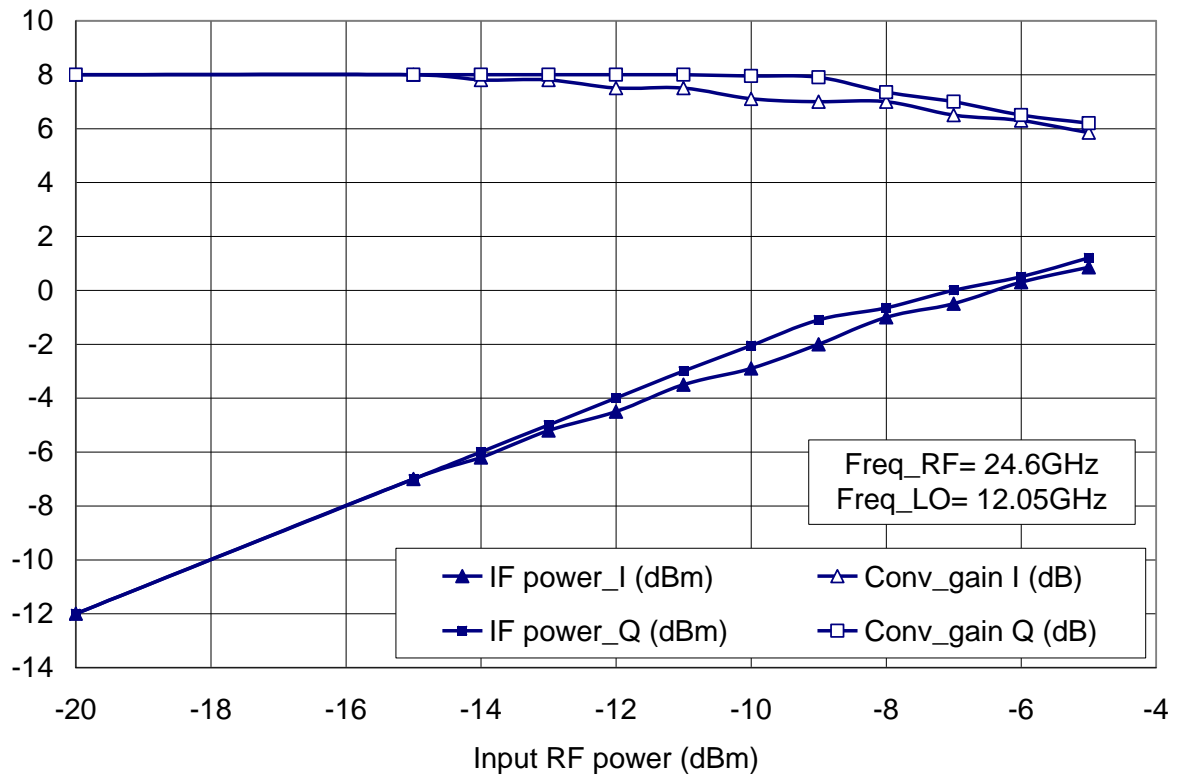

Input RF compression by channel

Typical On-board Measurements

Bias Conditions : $V_{dm} = V_{dl} = 3.5V$, $V_{gm} = V_{gx} = -0.9V$, $V_{gb} = V_{ga} = -0.3V$

All these measurements include the losses from the test board (typically 1dB for the conversion gain and 0.5dB for the Noise Figure).

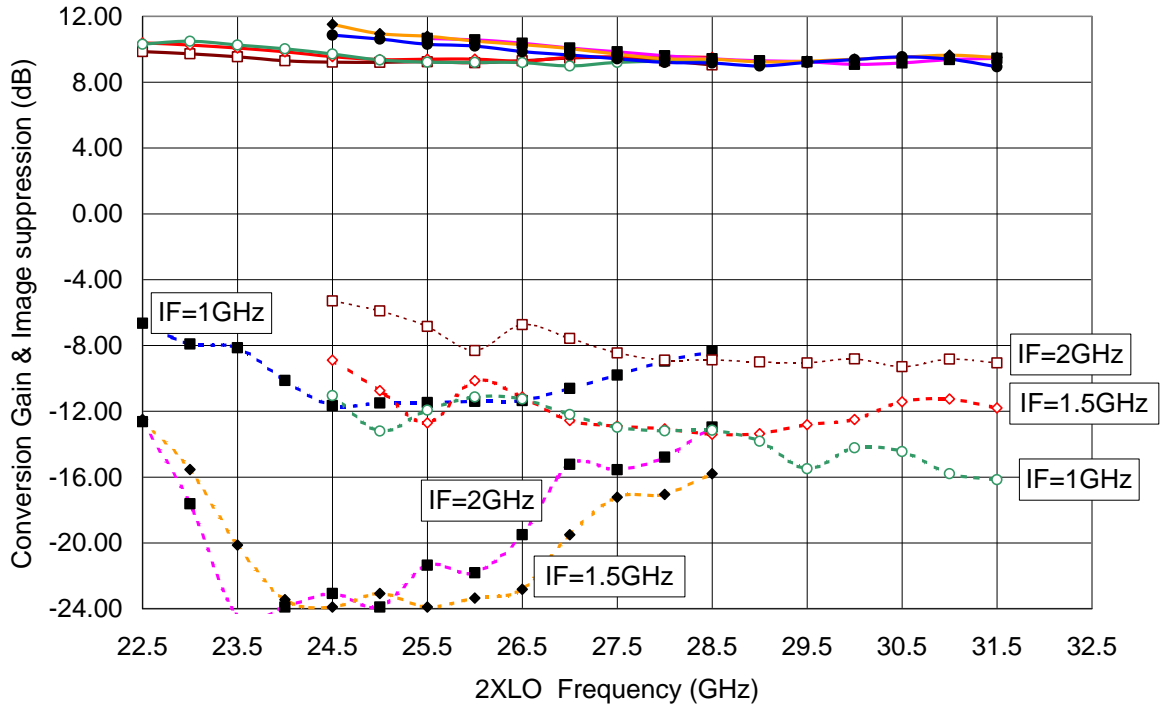

Conversion gain & Image suppression versus IF frequency

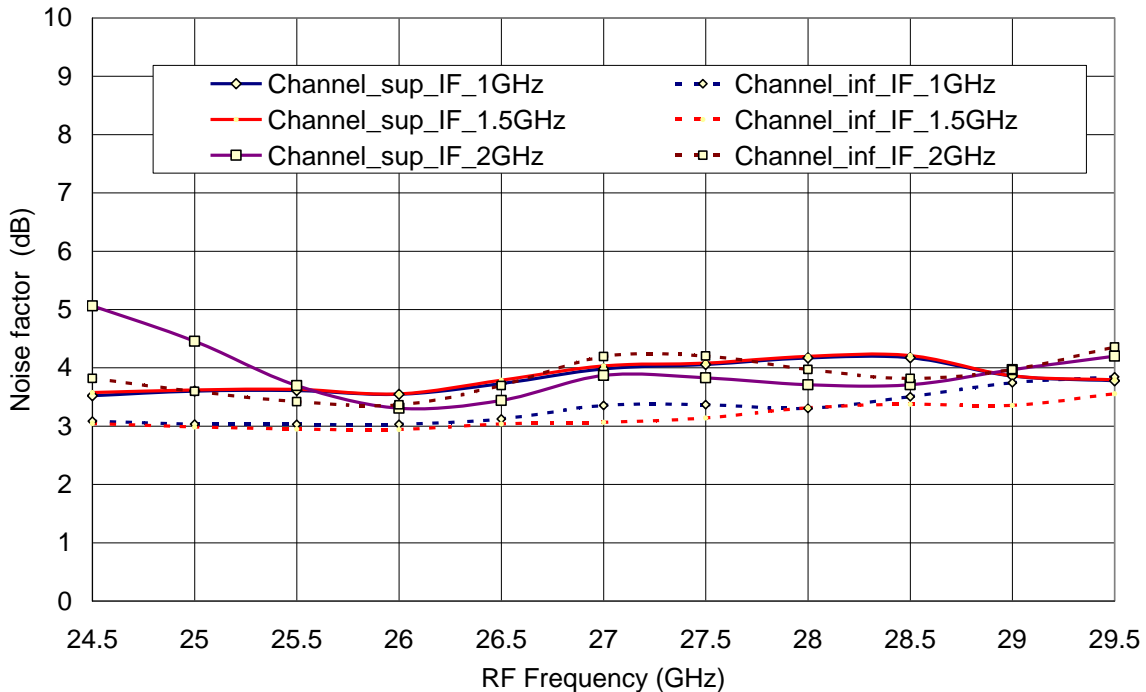

Noise figure supradyne & infradyne versus IF frequency

Chip Assembly and Mechanical Data

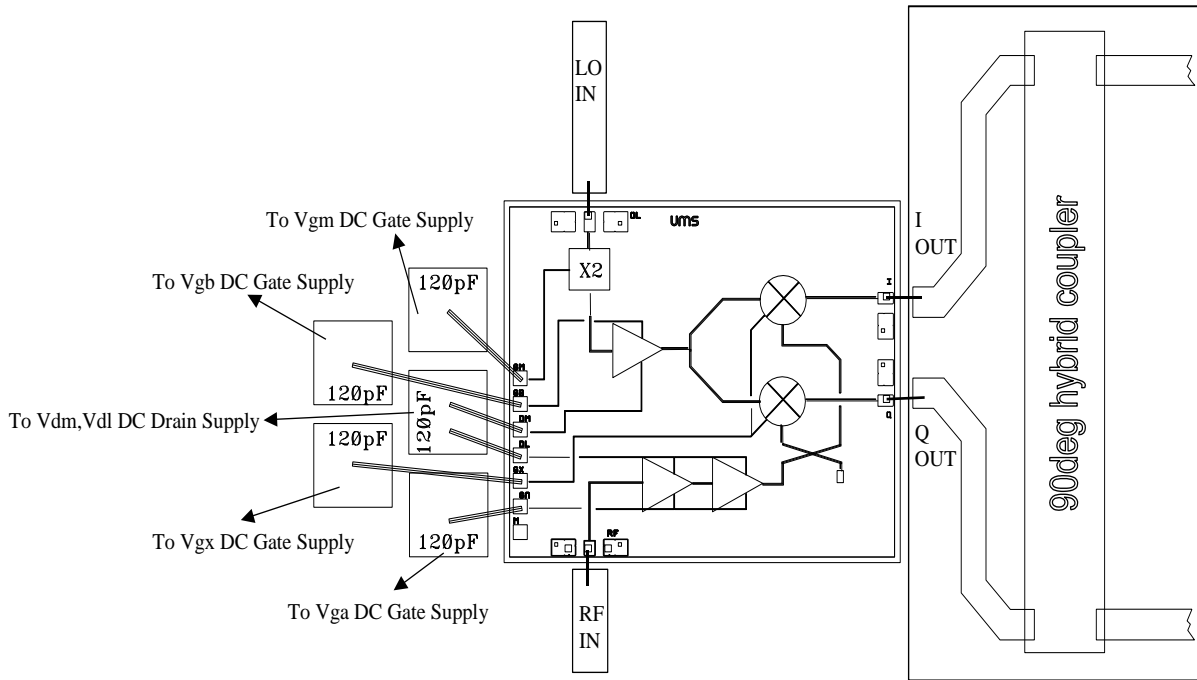

Note: Supply feed should be bypassed. 25µm diameter gold wire is recommended

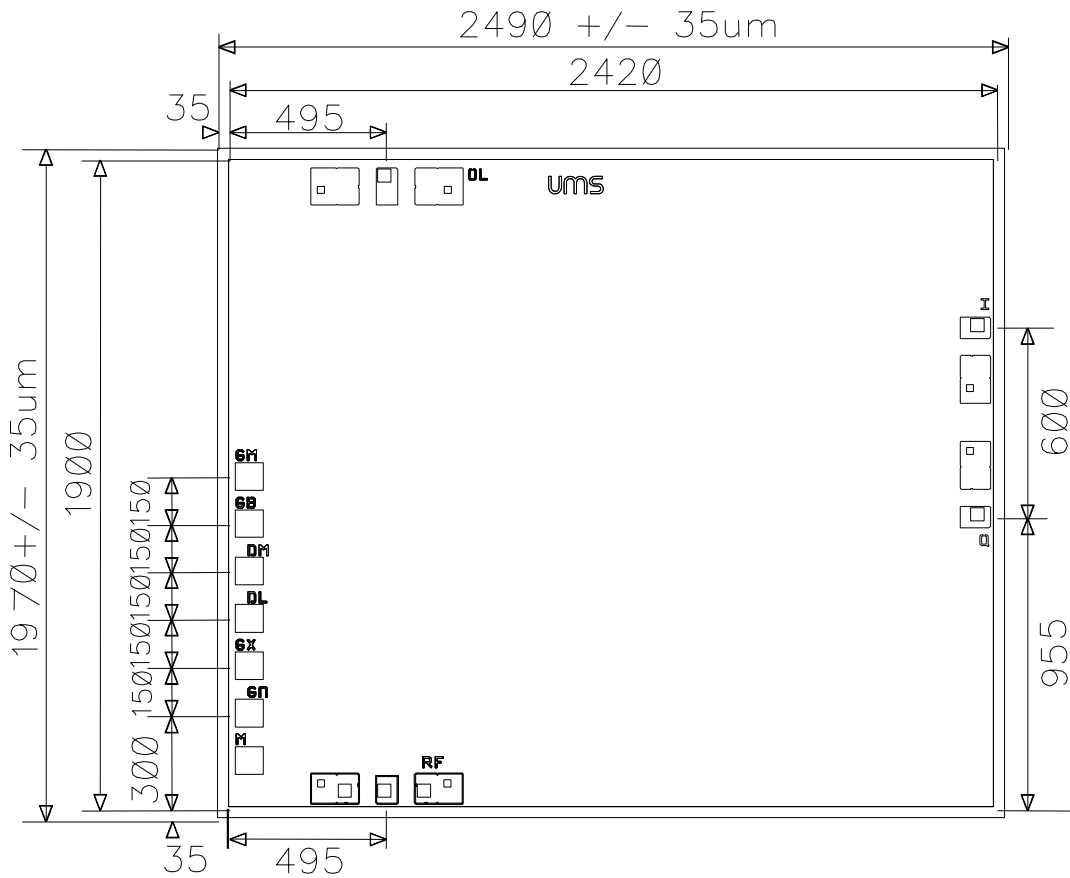

Bonding pad positions
(Chip thickness: 100µm. All dimensions are in micrometers)

Recommended ESD management

Refer to the application note AN0020 available at <http://www.ums-gaas.com> for ESD sensitivity and handling recommendations for the UMS products.

Ordering Information

Chip form: CHR2295-99F/00

Information furnished is believed to be accurate and reliable. However **United Monolithic Semiconductors S.A.S.** assumes no responsibility for the consequences of use of such information nor for any infringement of patents or other rights of third parties which may result from its use. No license is granted by implication or otherwise under any patent or patent rights of **United Monolithic Semiconductors S.A.S.** Specifications mentioned in this publication are subject to change without notice. This publication supersedes and replaces all information previously supplied. **United Monolithic Semiconductors S.A.S.** products are not authorised for use as critical components in life support devices or systems without express written approval from **United Monolithic Semiconductors S.A.S.**