

**PNP Silicon AF Transistors**

- For AF driver and output stages
- High collector current
- Low collector-emitter saturation voltage
- Complementary types: BCX54...BCX56 (NPN)
- Pb-free (RoHS compliant) package
- Qualified according AEC Q101



Type	Marking	Pin Configuration			Package
		1=B	2=C	3=E	
BCX51	AA	1=B	2=C	3=E	SOT89
BCX51-16	AD	1=B	2=C	3=E	SOT89
BCX52	AE	1=B	2=C	3=E	SOT89
BCX52-16	AM	1=B	2=C	3=E	SOT89
BCX53	AH	1=B	2=C	3=E	SOT89
BCX53-10	AK	1=B	2=C	3=E	SOT89
BCX53-16	AL	1=B	2=C	3=E	SOT89

**Maximum Ratings**

Parameter	Symbol	Value	Unit
Collector-emitter voltage	$V_{CEO}$	45 60 80	V
BCX51			
BCX52			
BCX53			
Collector-base voltage	$V_{CBO}$	45 60 100	
BCX51			
BCX52			
BCX53			
Emitter-base voltage	$V_{EBO}$	5	
Collector current	$I_C$	1	A
Peak collector current, $t_p \leq 10$ ms	$I_{CM}$	1.5	
Base current	$I_B$	100	mA
Peak base current	$I_{BM}$	200	
Total power dissipation $T_S \leq 120$ °C	$P_{tot}$	2	W
Junction temperature	$T_j$	150	°C
Storage temperature	$T_{stg}$	-65 ... 150	

**Thermal Resistance**

Parameter	Symbol	Value	Unit
Junction - soldering point <sup>1)</sup>	$R_{thJS}$	$\leq 15$	K/W

<sup>1)</sup>For calculation of  $R_{thJA}$  please refer to Application Note AN077 (Thermal Resistance Calculation)

**Electrical Characteristics at  $T_A = 25^\circ\text{C}$ , unless otherwise specified**

Parameter	Symbol	Values			Unit
		min.	typ.	max.	
<b>DC Characteristics</b>					
Collector-emitter breakdown voltage $I_C = 10\text{ mA}$ , $I_B = 0$ , BCX51	$V_{(BR)CEO}$	45	-	-	V
$I_C = 10\text{ mA}$ , $I_B = 0$ , BCX52		60	-	-	
$I_C = 10\text{ mA}$ , $I_B = 0$ , BCX53		80	-	-	
Collector-base breakdown voltage $I_C = 100\text{ }\mu\text{A}$ , $I_E = 0$ , BCX51	$V_{(BR)CBO}$	45	-	-	
$I_C = 100\text{ }\mu\text{A}$ , $I_E = 0$ , BCX52		60	-	-	
$I_C = 100\text{ }\mu\text{A}$ , $I_E = 0$ , BCX53		100	-	-	
Emitter-base breakdown voltage $I_E = 10\text{ }\mu\text{A}$ , $I_C = 0$	$V_{(BR)EBO}$	5	-	-	
Collector-base cutoff current $V_{CB} = 30\text{ V}$ , $I_E = 0$ $V_{CB} = 30\text{ V}$ , $I_E = 0$ , $T_A = 150\text{ }^\circ\text{C}$	$I_{CBO}$	-	-	0.1 20	$\mu\text{A}$
DC current gain <sup>1)</sup> $I_C = 5\text{ mA}$ , $V_{CE} = 2\text{ V}$ $I_C = 150\text{ mA}$ , $V_{CE} = 2\text{ V}$ , BCX51...BCX53 $I_C = 150\text{ mA}$ , $V_{CE} = 2\text{ V}$ , BCX53-10 $I_C = 150\text{ mA}$ , $V_{CE} = 2\text{ V}$ , BCX51-16...BCX53-16 $I_C = 500\text{ mA}$ , $V_{CE} = 2\text{ V}$	$h_{FE}$	25 40 63 100 25	- - 100 160 -	- 250 160 250 -	-
Collector-emitter saturation voltage <sup>1)</sup> $I_C = 500\text{ mA}$ , $I_B = 50\text{ mA}$	$V_{CEsat}$	-	-	0.5	V
Base-emitter voltage <sup>1)</sup> $I_C = 500\text{ mA}$ , $V_{CE} = 2\text{ V}$	$V_{BE(ON)}$	-	-	1	
<b>AC Characteristics</b>					
Transition frequency $I_C = 50\text{ mA}$ , $V_{CE} = 10\text{ V}$ , $f = 20\text{ MHz}$	$f_T$	-	125	-	MHz

<sup>1</sup>Pulse test:  $t < 300\mu\text{s}$ ;  $D < 2\%$

**DC current gain  $h_{FE} = f(I_C)$**

$V_{CE} = 2\text{ V}$

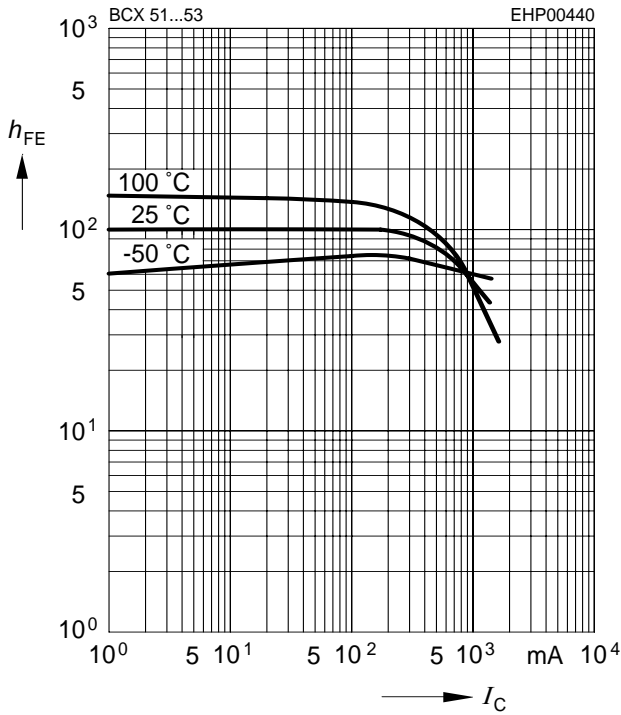

**Collector-emitter saturation voltage**

$I_C = f(V_{CEsat}), h_{FE} = 10$

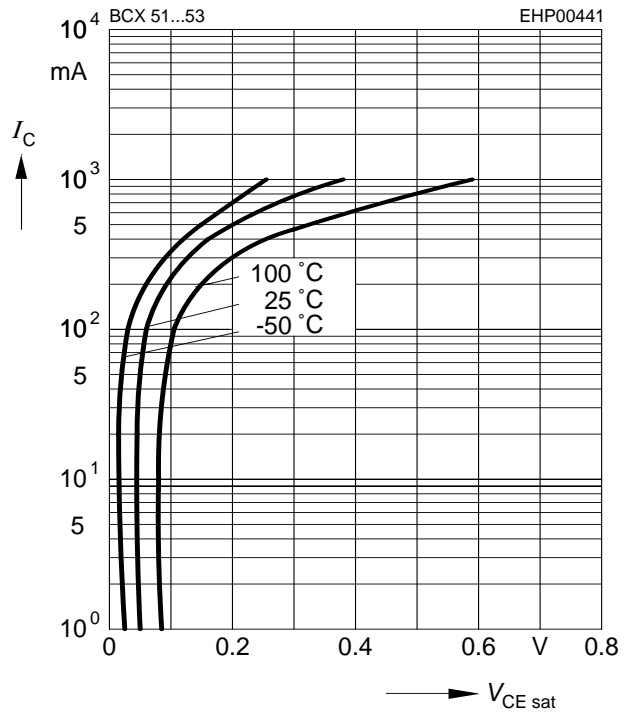

**Base-emitter saturation voltage**

$I_C = f(V_{BEsat}), h_{FE} = 10$

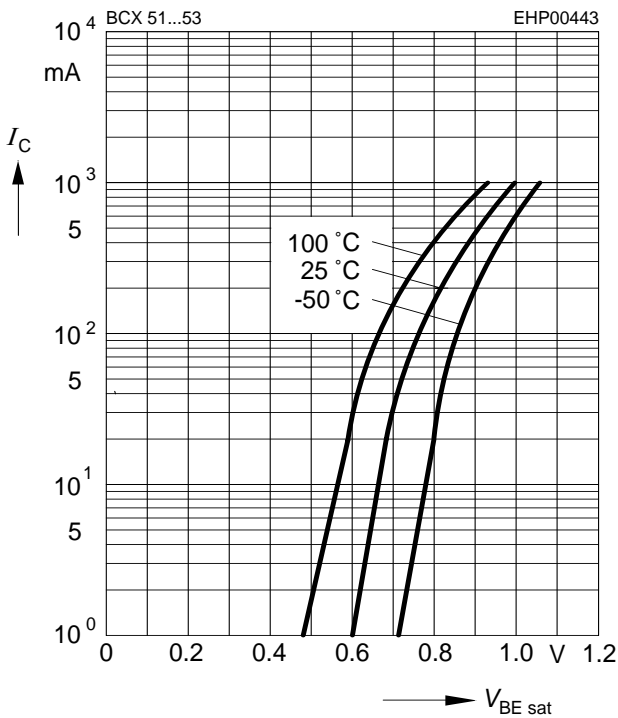

**Collector current  $I_C = f(V_{BE})$**

$V_{CE} = 2\text{ V}$

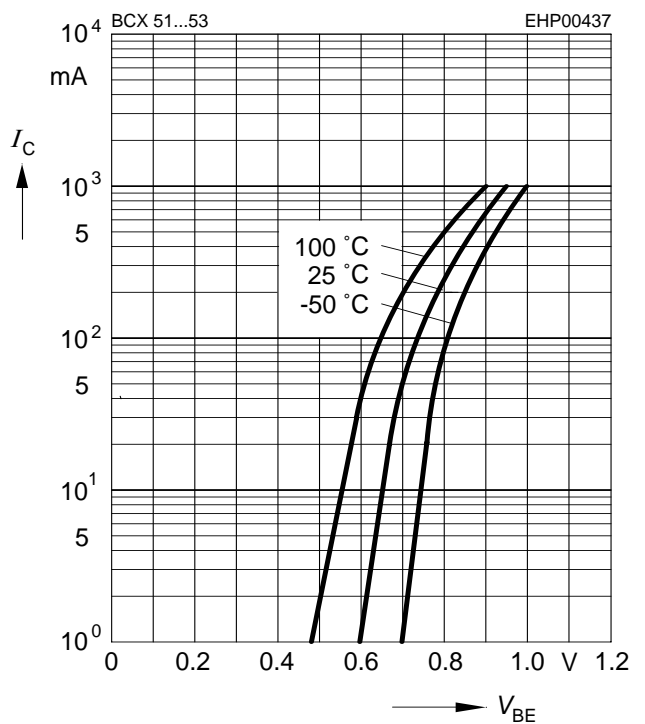

**Collector cutoff current  $I_{CBO} = f(T_A)$**

$V_{CBO} = 30\text{ V}$

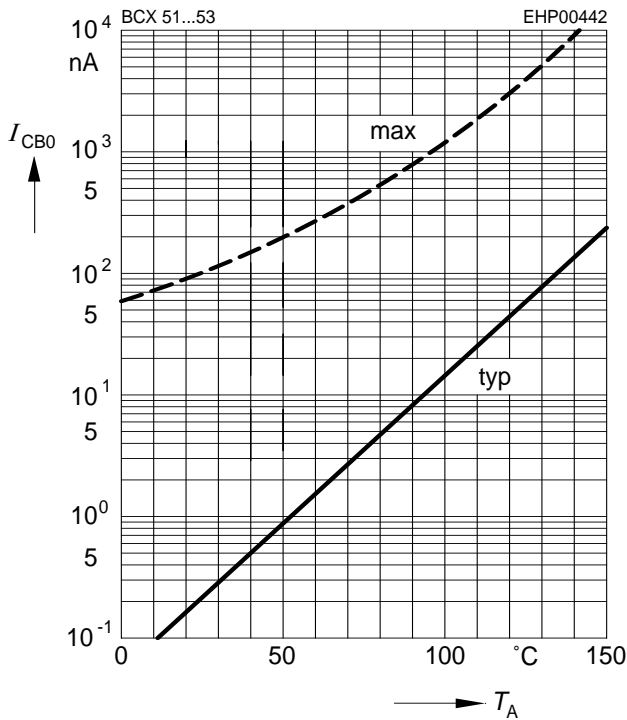

**Transition frequency  $f_T = f(I_C)$**

$V_{CE} = 10\text{ V}$

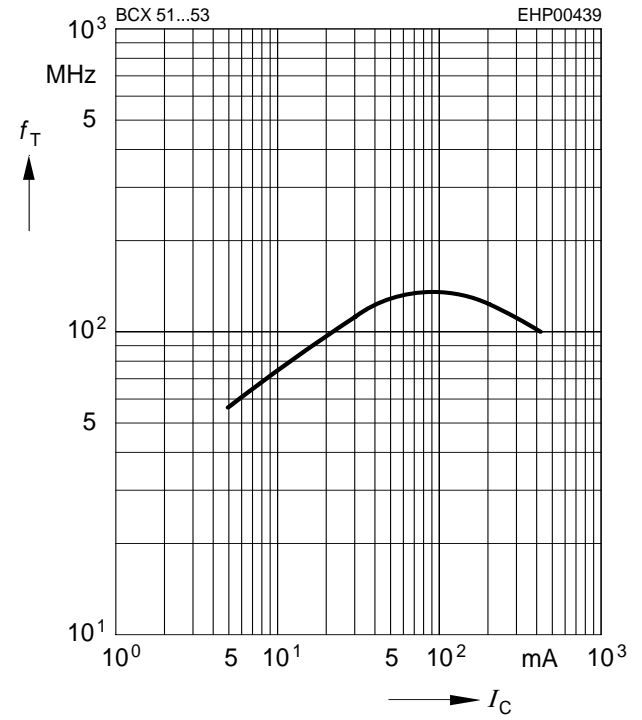

**Total power dissipation  $P_{tot} = f(T_S)$**

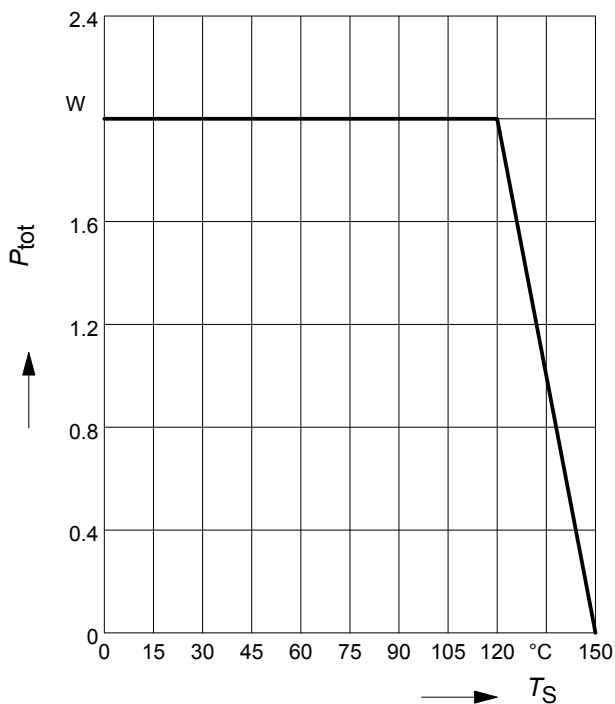

**Permissible Pulse Load  $R_{thJS} = f(t_p)$**

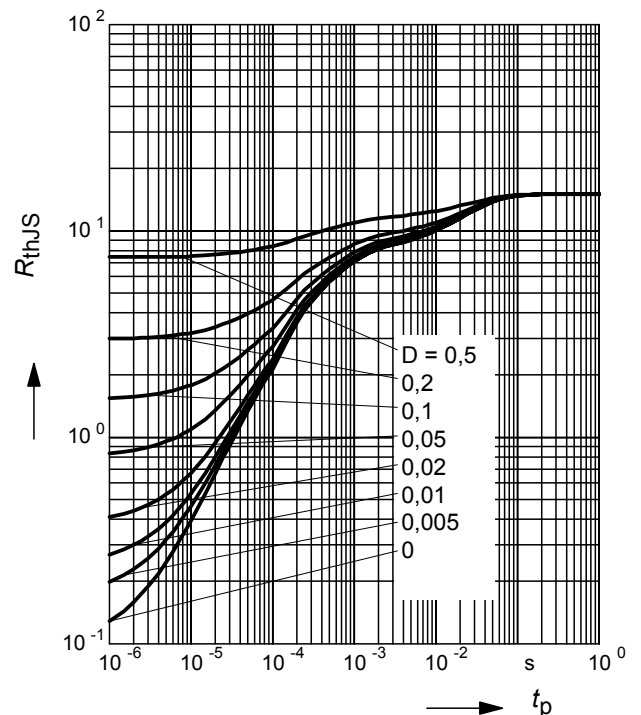

**Permissible Pulse Load**

$$P_{\text{totmax}}/P_{\text{totDC}} = f(t_p)$$



Package Outline

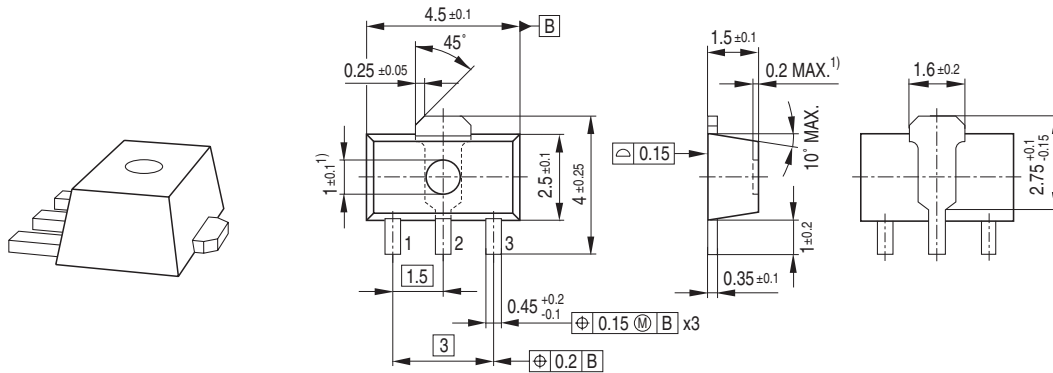

1) Ejector pin markings possible

Foot Print

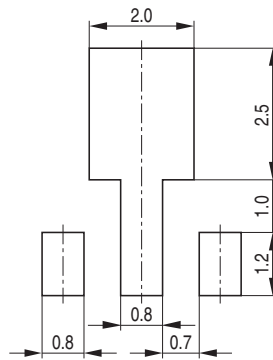

Marking Layout (Example)

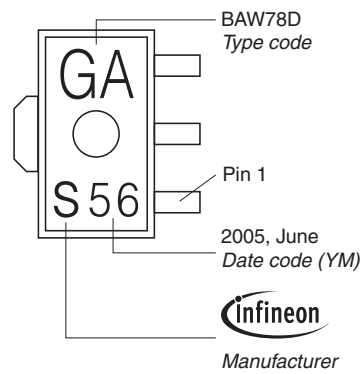

Standard Packing

Reel  $\varnothing 180 \text{ mm} = 1.000 \text{ Pieces/Reel}$   
 Reel  $\varnothing 330 \text{ mm} = 4.000 \text{ Pieces/Reel}$

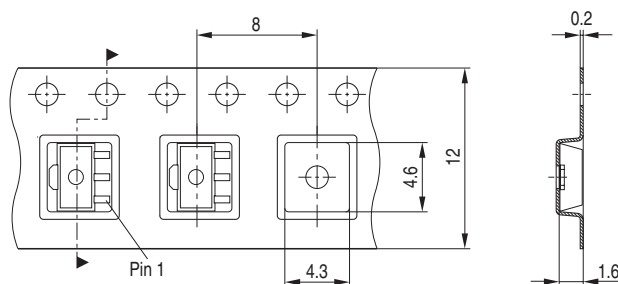

**Edition 2009-11-16**

**Published by  
Infineon Technologies AG  
81726 Munich, Germany**

**© 2009 Infineon Technologies AG  
All Rights Reserved.**

### **Legal Disclaimer**

The information given in this document shall in no event be regarded as a guarantee of conditions or characteristics. With respect to any examples or hints given herein, any typical values stated herein and/or any information regarding the application of the device, Infineon Technologies hereby disclaims any and all warranties and liabilities of any kind, including without limitation, warranties of non-infringement of intellectual property rights of any third party.

### **Information**

For further information on technology, delivery terms and conditions and prices, please contact the nearest Infineon Technologies Office ([www.infineon.com](http://www.infineon.com)).

### **Warnings**

Due to technical requirements, components may contain dangerous substances. For information on the types in question, please contact the nearest Infineon Technologies Office.

Infineon Technologies components may be used in life-support devices or systems only with the express written approval of Infineon Technologies, if a failure of such components can reasonably be expected to cause the failure of that life-support device or system or to affect the safety or effectiveness of that device or system. Life support devices or systems are intended to be implanted in the human body or to support and/or maintain and sustain and/or protect human life. If they fail, it is reasonable to assume that the health of the user or other persons may be endangered.