

THIS DRAWING IS UNPUBLISHED. RELEASED FOR PUBLICATION  
 © COPYRIGHT - ALL RIGHTS RESERVED.

LOC		DIST		REVISIONS					
H		-		P	LTR	DESCRIPTION	DATE	DWN	APVD
					S2	ADDED NOTE INDICATING POLARISATION SLOT	290CT2012	SP	RP

REFERENCE MATING INTERFACE PATTERN:  
 1,27 STAGGERED PITCH x 1,5 ROW-DISTANCE.

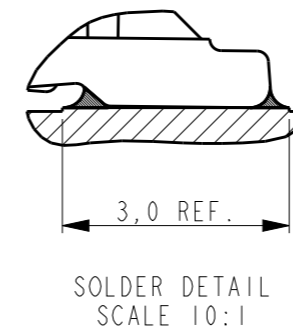
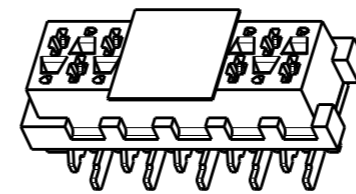
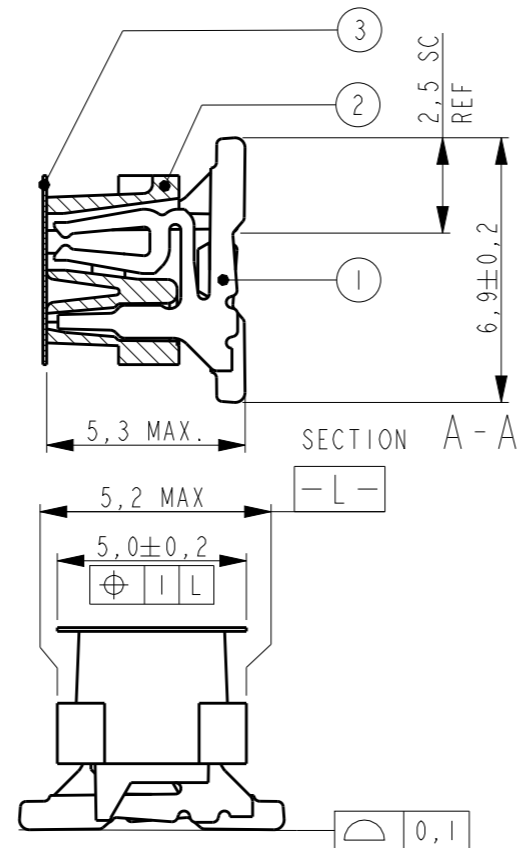
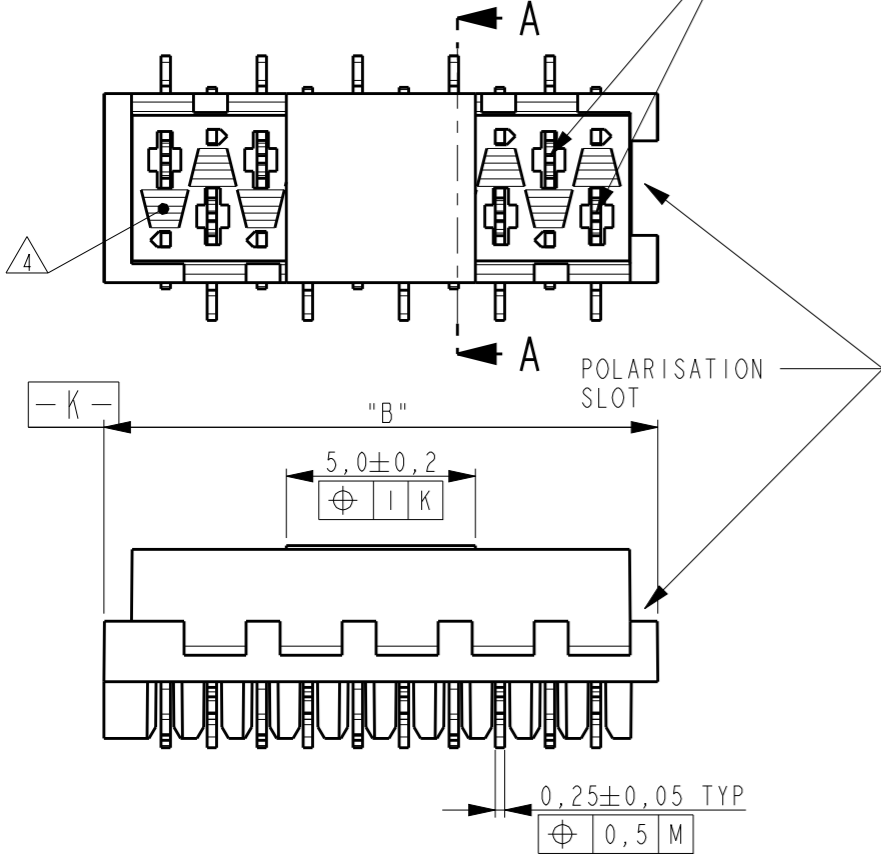

△1 PARTNUMBER VAC. TAPE.	△3 PARTNUMBER	NR. OF POS. "n"	"A"	"B" MAX.
7-188275-4	0-188275-4	4	3,81	7,1
7-188275-6	0-188275-6	6	6,35	9,7
7-188275-8	0-188275-8	8	8,89	12,2
8-188275-0	1-188275-0	10	11,43	14,7
8-188275-2	1-188275-2	12	13,97	17,3
8-188275-4	1-188275-4	14	16,51	19,8
8-188275-6	1-188275-6	16	19,05	22,4
8-188275-8	1-188275-8	18	21,59	24,9
9-188275-0	2-188275-0	20	24,13	27,5

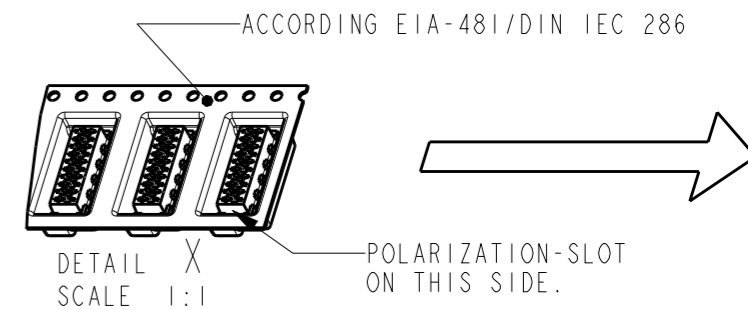
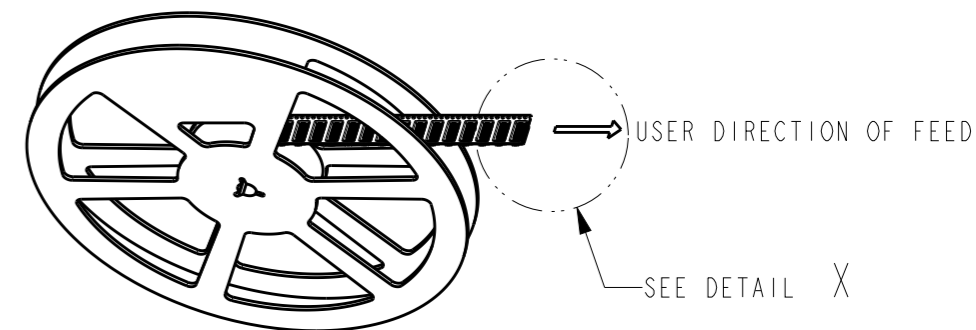
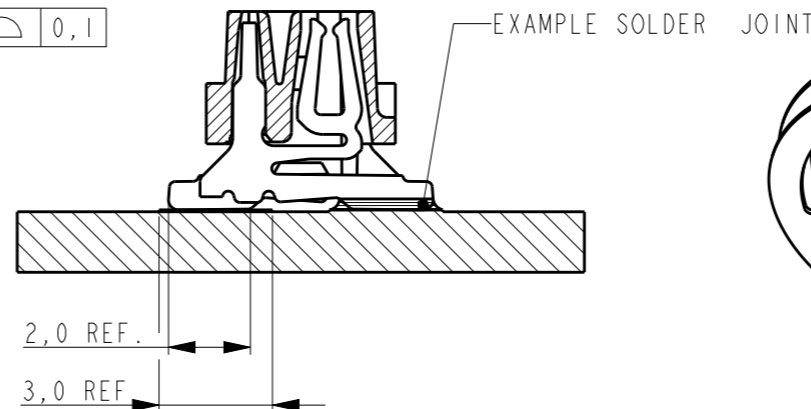

NOTES:

- △1 TAPE FOR VACUUM P&P ONLY FOR DASHNUMBERS 7- /8- /9-
- 2 FOR PACKAGING SEE SHEET 2 OF 2
- △3 WITHOUT VACUUM TAPE.
- △4 CORING-OUTS FOR MANUFACTURING PURPOSE ONLY. SHAPE MAY VARY, BUT IS NOT FUNCTIONAL FOR THE APPLICATION.
- 5 SHOWN IS A 10 POSITION CONNECTOR.

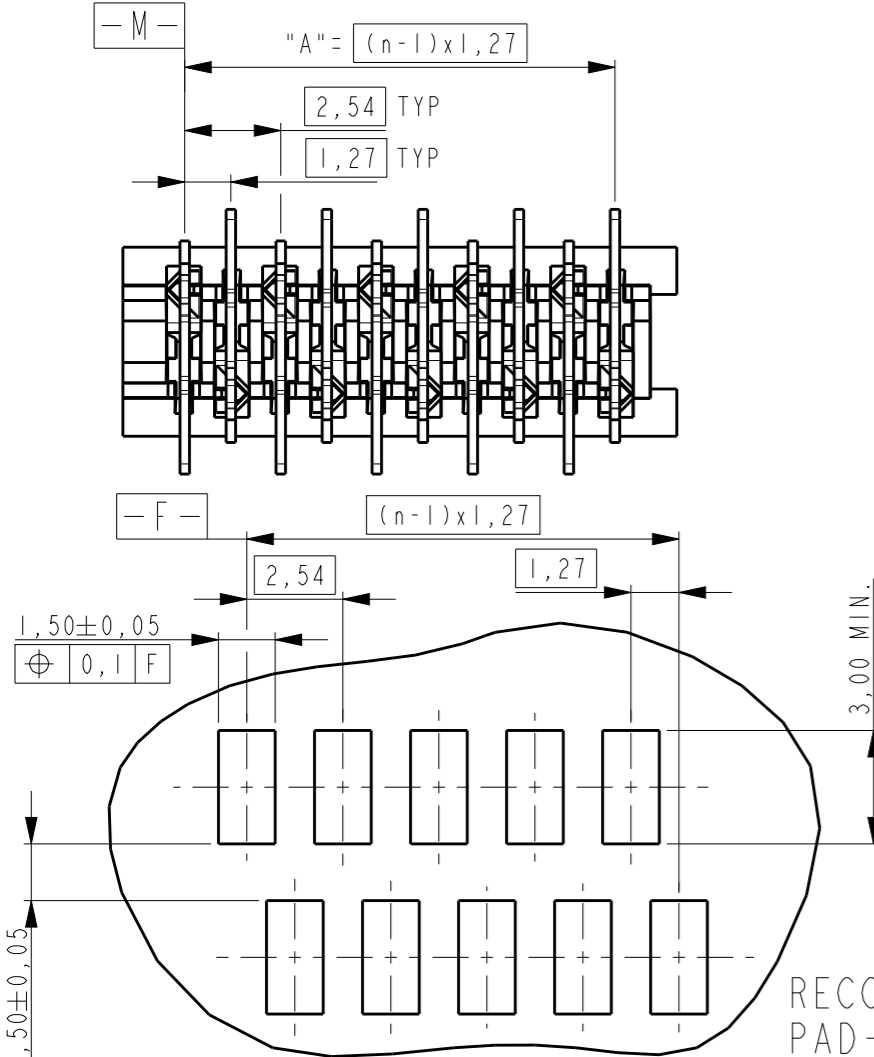

ITEM NO.	COMPONENT DESCRIPTION	MATERIAL	FINISH / COLOR
3	PICK&PLACE TAPE	KAPTON	AMBER TRANSPARENT
2	FEMALE HOUSING	G.F. POLYAMIDE	RED
1	FEMALE CONTACT	PHOSPHOR BRONZE	TIN OVER NICKEL

THIS DRAWING IS A CONTROLLED DOCUMENT.		DWN M. GOSSELINK		 TE Connectivity CONNECTOR, FEMALE-ON-BOARD TOP-ENTRY, SMD, Micro-MatCh	
DIMENSIONS: mm		TOLERANCES UNLESS OTHERWISE SPECIFIED:			
MATERIAL -		FINISH -			
CUSTOMER DRAWING		SCALE 5:1			
0 PLC ±- 1 PLC ±- 2 PLC ±- 3 PLC ±- 4 PLC ±- ANGLES ±-		PRODUCT SPEC 108-19052 APPLICATION SPEC - WEIGHT -		NAME SIZE A3 CAGE CODE 00779 DRAWING NO C-188275 RESTRICTED TO -	
		SHEET 1 OF 2		REV S2	

THIS DRAWING IS UNPUBLISHED.

RELEASED FOR PUBLICATION

© COPYRIGHT -

ALL RIGHTS RESERVED.

LOC H DIST -

P LTR

REVISIONS

DESCRIPTION

DATE

DWN

APVD

SEE SHEET 1

TAPE WIDTH 24 mm

TAPE WIDTH 44 mm

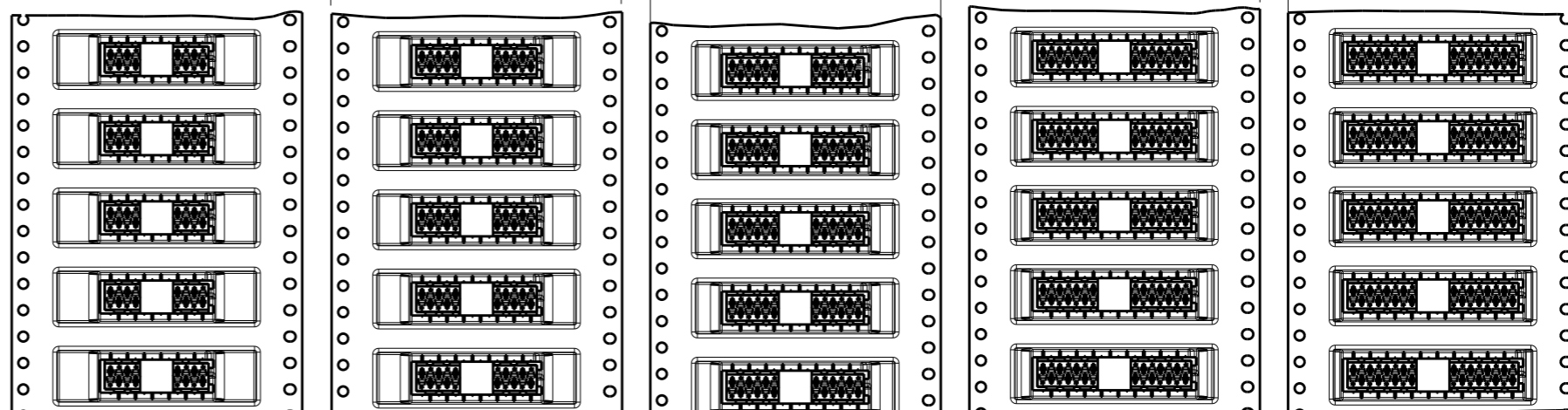
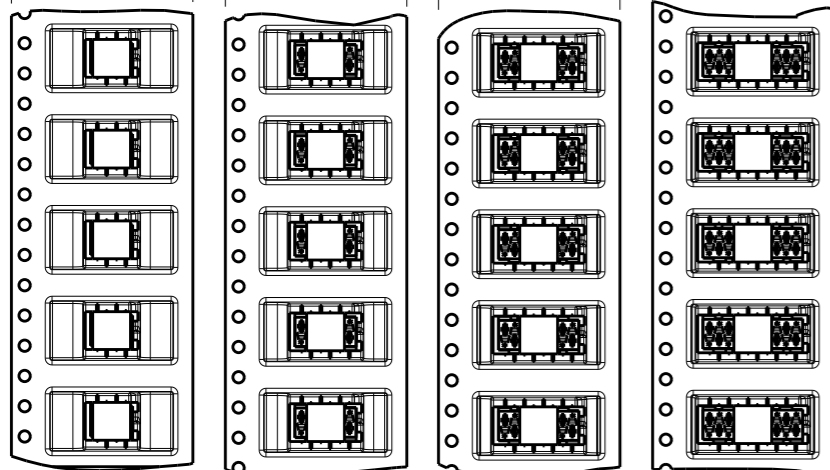

7-188275-4	7-188275-6	7-188275-8	8-188275-0
4 POSITION	6 POSITION	8 POSITION	10 POSITION
0-188275-4	0-188275-6	0-188275-8	1-188275-0

8-188275-2	8-188275-4	8-188275-6	8-188275-8	9-188275-0
12 POSITION	14 POSITION	16 POSITION	18 POSITION	20 POSITION
1-188275-2	1-188275-4	1-188275-6	1-188275-8	2-188275-0

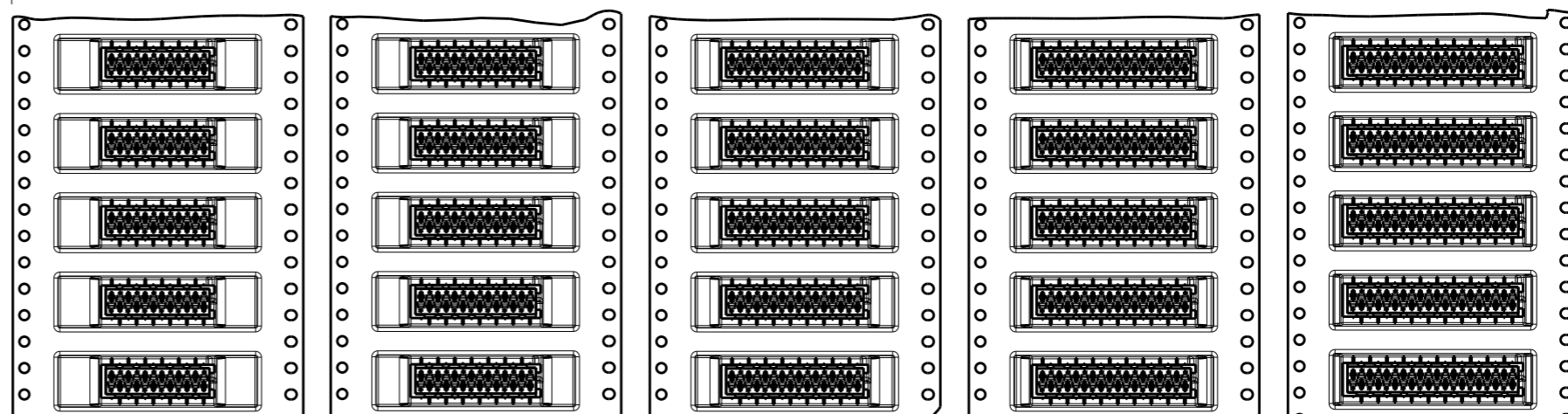
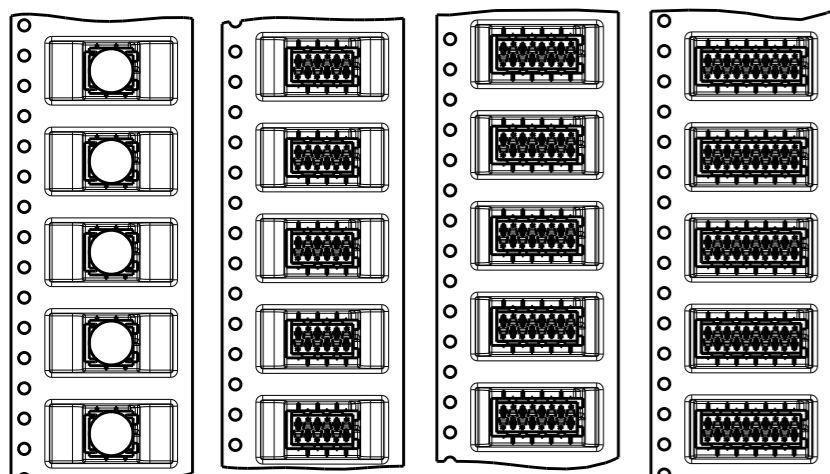

THIS DRAWING IS A CONTROLLED DOCUMENT.

DWN M. GOSSELINK  
 CHK -  
 APVD -



DIMENSIONS:

mm

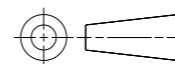

TOLERANCES UNLESS OTHERWISE SPECIFIED:

0 PLC	±-
1 PLC	±0.1
2 PLC	±0.05
3 PLC	±-
4 PLC	±-
ANGLES	±-

MATERIAL -

FINISH -

PRODUCT SPEC 108-19052

APPLICATION SPEC -

WEIGHT -

NAME  
 CONNECTOR,  
 FEMALE-ON-BOARD TOP-ENTRY,  
 SMD, Micro-MaTch

SIZE A3	CAGE CODE 00779	DRAWING NO C-188275	RESTRICTED TO -
---------	-----------------	---------------------	-----------------

CUSTOMER DRAWING

SCALE 1:1 SHEET 2 OF 2 REV S2