

THRESHOLD DETECTOR *TMJ9904*

Packaging Options

RNJ9904, 4 Pin Sq. Surface Mount (SM-19)

TMJ9904, 5 Pin TO-8

TNJ9904, 4 Pin Sq. Surface Mount (SM-3)

BXJ9904, SMA Connectorized Housing (H-6)

Features

- External Threshold Control ; Voltage or Resistance
- -20 dBm to + 10 dBm Input Operating Range
- **Wide 10 MHz to 2000 MHz Bandwidth**

Specifications

CHARACTERISTIC	TYPICAL Ta= 0 to 60 °C	MIN/MAX Ta = -55 °C to +85 °C
Input Flatness (dB) P = -20 to + 10dBm	+/- 1.0	+/- 1.5 Max.
Input VSWR (Max)	<1.75:1	2.0:1 Max.
Threshold Control Level (V/Ohms) @ P _{IN} = -20 dBm @ P _{IN} = 0 dBm @ P _{IN} = +10 dBm	.026/200 .265/2.0K .870/6.5K	- - -
Threshold Temp. Stability (dB) @ P _{IN} = -20 dBm @ P _{IN} = 0 dBm @ P _{IN} = +10 dBm	- - -	+/- 1.5 Max. +/- 1.0 Max. +/- 0.5 Max.
Threshold Hysteresis Voltage Control (dB) Resistance Control (dB)	<0.1 >1.0	- -
Output @ P _{IN} = Threshold (V)	3.2	2.7 Min
Output Short Circuit Current (mA)	8	3.0 Min.
Rise Time/Fall Time (ns)	75	125
Power Vdc mA	+15 3	+15 5 Max.

Note: Care should always be taken to effectively ground the case of each unit.

Absolute Maximum (No Damage) Ratings

Operating Case Temperature..... -55 °C to +125 °C

Storage Temperature..... -62 °C to +150 °C

Continuous RF Input Power.....+15 dBm

DC Voltage.....+17 Volts

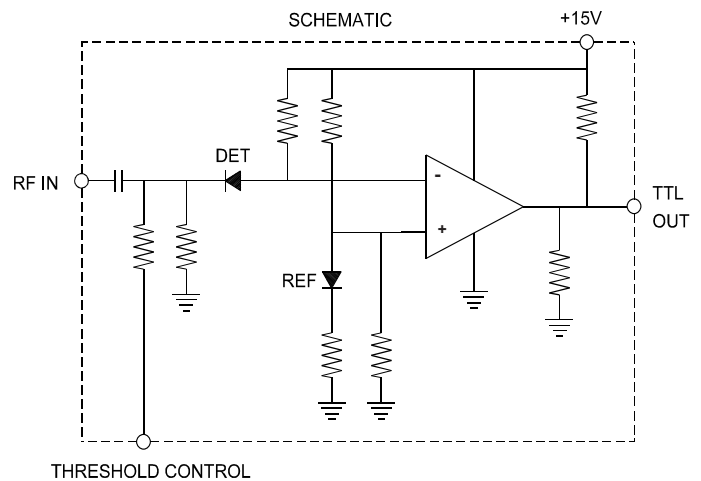

Typical Performance Data

Control Voltage & Resistance vs. Input Power

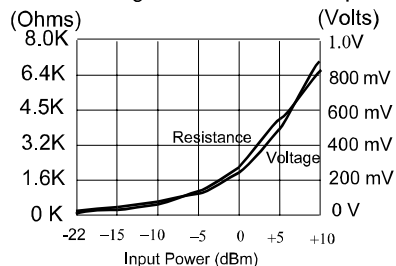

Input VSWR

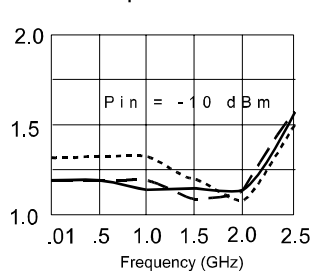

Input Power Flatness (dBm)

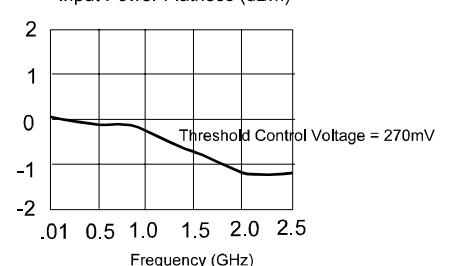

Hysteresis

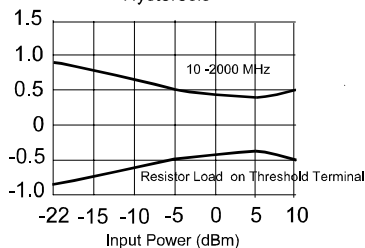

Threshold Power vs. Frequency

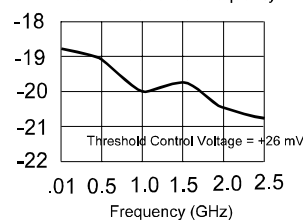

Threshold Power vs. Frequency

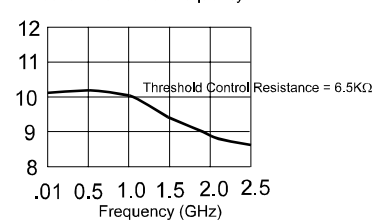

Spectrum Microwave · 2144 Franklin Drive N.E. · Palm Bay, Florida 32905 · PH (888) 553-7531 · Fax (888) 553-7532

Rev.
2/9/07

www.SpectrumMicrowave.com Spectrum Microwave · 2707 Black Lake Place · Philadelphia, Pennsylvania 19154 · PH (215) 464-4000 · Fax (215) 464-4001