

For FPC/FFC*	<h1>Y5B/Y5BW</h1> Series
<b>FPC connectors (0.5mm pitch) Back lock</b>	

**FEATURES**

- 1. Low profile, space saving back lock type with improved lever operability
- 2. Mechanical design freedom achieved by top and bottom double contacts

3. Wide selection, including a type with a small number of pins  
 Low profile and space saving design of 1.0 mm high and 3.20 mm deep (3.70 mm with lever)  
 Y5B and Y5BW can have a minimum of four and two contacts respectively, maximum reduction in design packaging.

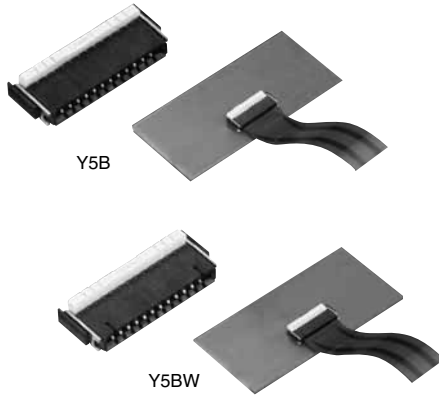

**RoHS compliant**

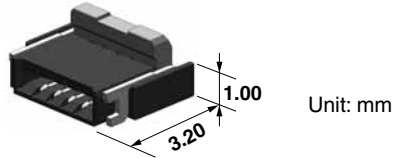

4 pin contacts (Y5B: minimum)

- 4. Wiring patterns can be placed underneath the connector.
- 5. Man-hours for assembly can be reduced by delivering the connectors with their levers opened.
- 6. Y5BW features advanced functionality, including a structure to temporarily hold the FPC and a higher holding force.

The FPC holding contacts located on both ends of the connector facilitate positioning of FPC and further enhance the FPC holding force.

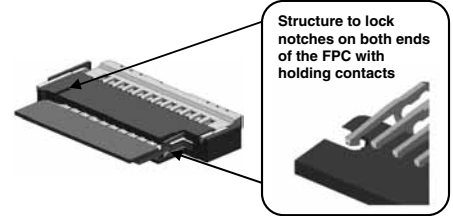

Applicable FPC shape



With notches

- (1) The inserted FPC can be temporarily held until the lever is closed.
- (2) When the lever is closed, the holding contacts lock the FPC by its through-holes and notches, enhancing the FPC holding force.

\* (Y5BW is compatible with FPC only.)

**APPLICATIONS**

A wide range of digital equipment, including mobile phones, smartphones, PCs, digital still camera, and digital video camera. Ideal for touch panels and LCD backlights, which require connectors with a small number of pins.

**ORDERING INFORMATION**

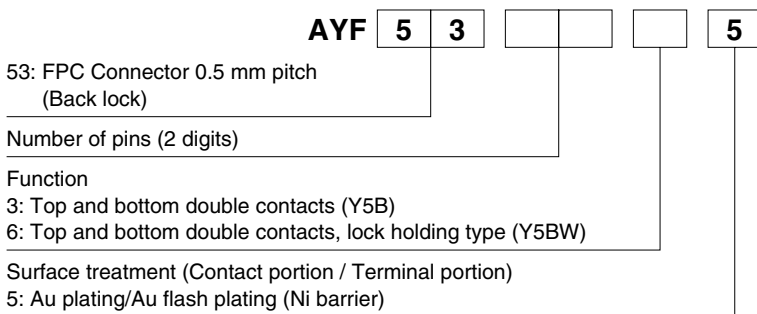

## PRODUCT TYPES

Height	Y5B		Y5BW		Packing	
	Number of pins	Part number	Number of pins	Part number	Inner carton (1-reel)	Outer carton
1.0 mm	4	AYF530435	2	AYF530265	5,000 pieces	10,000 pieces
	5	AYF530535	3	AYF530365		
	6	AYF530635	4	AYF530465		
	8	AYF530835	6	AYF530665		
	10	AYF531035	8	AYF530865		
	12	AYF531235	10	AYF531065		
	14	AYF531435	12	AYF531265		
	16	AYF531635	14	AYF531465		
	24	AYF532435	22	AYF532265		
	28	AYF532835	26	AYF532665		
	30	AYF533035	28	AYF532865		
	32	AYF533235	30	AYF533065		
	34	AYF533435	32	AYF533265		
	40	AYF534035	38	AYF533865		
	42	AYF534235	40	AYF534065		
50	AYF535035	48	AYF534865			

- Notes: 1. Order unit:  
 For volume production: 1-inner carton (1-reel) units  
 Samples for mounting check: 50-connector units. Please contact our sales office.  
 2. Please contact our sales office for connectors having a number of pins other than those listed above.

## SPECIFICATIONS

### 1. Characteristics

	Item	Specifications	Conditions																		
Electrical characteristics	Rated current	0.5A/pin contact (Except for holding contact)																			
	Rated voltage	50V AC/DC																			
	Insulation resistance	Min. 1.000MΩ (initial)	Using 250V DC megger (applied for 1 min.)																		
	Breakdown voltage	250V AC for 1 min.	No short-circuiting or damage at a detection current of 1 mA when the specified voltage is applied for one minute.																		
	Contact resistance	Max. 100mΩ	Based on the contact resistance measurement method specified by JIS C 5402.																		
Mechanical characteristics	FPC holding force	Y5B: Min. 0.2N/pin contacts × pin contacts (initial) Y5BW: Min. 0.2N/pin contacts × pin contacts + 2.0N (initial)	Measurement of the maximum force applied until the inserted compatible FPC is pulled out in the insertion axis direction while the connector lever is closed																		
Environmental characteristics	Ambient temperature	-55°C to +85°C	No freezing at low temperatures. No dew condensation.																		
	Storage temperature	-55°C to +85°C (product only) -40°C to +50°C (emboss packing)																			
	Thermal shock resistance (with FPC inserted)	5 cycles, insulation resistance min. 100MΩ, contact resistance max. 100mΩ	Conformed to MIL-STD-202F, method 107G <table border="1"> <thead> <tr> <th>Order</th> <th>Temperature (°C)</th> <th>Time (minutes)</th> </tr> </thead> <tbody> <tr> <td>1</td> <td>-55<sup>3</sup>/<sub>3</sub></td> <td>30</td> </tr> <tr> <td>2</td> <td>∅</td> <td>Max. 5</td> </tr> <tr> <td>3</td> <td>85<sup>+3</sup>/<sub>3</sub></td> <td>30</td> </tr> <tr> <td>4</td> <td>∅</td> <td>Max. 5</td> </tr> <tr> <td></td> <td>-55<sup>3</sup>/<sub>3</sub></td> <td></td> </tr> </tbody> </table>	Order	Temperature (°C)	Time (minutes)	1	-55 <sup>3</sup> / <sub>3</sub>	30	2	∅	Max. 5	3	85 <sup>+3</sup> / <sub>3</sub>	30	4	∅	Max. 5		-55 <sup>3</sup> / <sub>3</sub>	
	Order	Temperature (°C)	Time (minutes)																		
	1	-55 <sup>3</sup> / <sub>3</sub>	30																		
	2	∅	Max. 5																		
	3	85 <sup>+3</sup> / <sub>3</sub>	30																		
4	∅	Max. 5																			
	-55 <sup>3</sup> / <sub>3</sub>																				
Humidity resistance (with FPC inserted)	120 hours, insulation resistance min. 100MΩ, contact resistance max. 100mΩ	Bath temperature 40±2°C, humidity 90 to 95% R.H.																			
Saltwater spray resistance (with FPC inserted)	24 hours, insulation resistance min. 100MΩ, contact resistance max. 100mΩ	Bath temperature 35±2°C, saltwater concentration 5±1%																			
H <sub>2</sub> S resistance (with FPC inserted)	48 hours, contact resistance max. 100mΩ	Bath temperature 40±2°C, gas concentration 3±1 ppm, humidity 75 to 80% R.H.																			
Soldering heat resistance	Peak temperature: 260°C or less 300°C within 5 sec. 350°C within 3 sec.	Reflow soldering Soldering iron																			
Lifetime characteristics	Insertion and removal life	20 times	Repeated insertion and removal: min. 10 sec./time																		
Unit weight		Y5B (50 pin contacts): 0.16 g																			

### 2. Material and surface treatment

Part name	Material	Surface treatment
Molded portion	Housing: LCP resin (UL94V-0) Lever: LCP resin (UL94V-0)	—
Contact	Copper alloy	Contact portion; Base: Ni plating, Surface: Au plating Terminal portion; Base: Ni plating, Surface: Au plating
Holding contact portion	Copper alloy	Terminal portion; Base: Ni plating, Surface: Au plating
Soldering terminals portion	Copper alloy	Base: Ni plating, Surface: Au plating

**DIMENSIONS** (Unit: mm)

The CAD data of the products with a **CAD Data** mark can be downloaded from: <http://industrial.panasonic.com/ac/e/>

Y5B

**CAD Data**

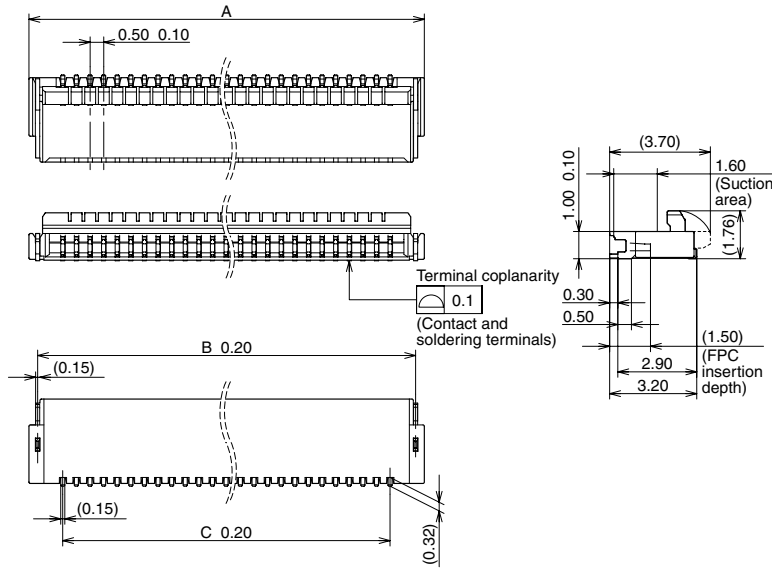

Number of pins/ dimension	A	B	C
4	4.00	3.36	1.50
5	4.50	3.86	2.00
6	5.00	4.36	2.50
8	6.00	5.36	3.50
10	7.00	6.36	4.50
12	8.00	7.36	5.50
14	9.00	8.36	6.50
16	10.00	9.36	7.50
24	14.00	13.36	11.50
28	16.00	15.36	13.50
30	17.00	16.36	14.50
32	18.00	17.36	15.50
34	19.00	18.36	16.50
40	22.00	21.36	19.50
42	23.00	22.36	20.50
50	27.00	26.36	24.50

**Y5B RECOMMENDED FPC/FFC DIMENSIONS**

(Finished thickness: t = 0.3 0.03)

The conductive parts should be based by Ni plating and then Au plating.

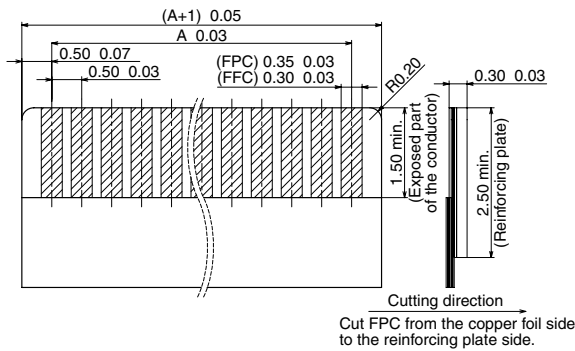

Number of pins/ dimension	A
4	1.50
5	2.00
6	2.50
8	3.50
10	4.50
12	5.50
14	6.50
16	7.50
24	11.50
28	13.50
30	14.50
32	15.50
34	16.50
40	19.50
42	20.50
50	24.50

Y5BW

**CAD Data**

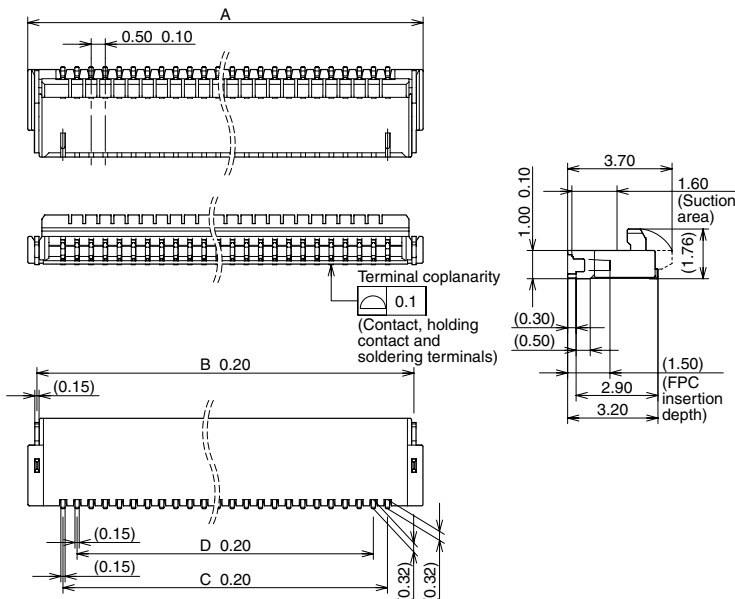
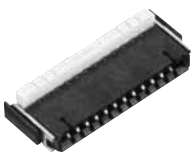

Number of pins/ dimension	A	B	C	D
2	4.00	3.36	1.50	0.50
3	4.50	3.86	2.00	1.00
4	5.00	4.36	2.50	1.50
6	6.00	5.36	3.50	2.50
8	7.00	6.36	4.50	3.50
10	8.00	7.36	5.50	4.50
12	9.00	8.36	6.50	5.50
14	10.00	9.36	7.50	6.50
22	14.00	13.36	11.50	10.50
26	16.00	15.36	13.50	12.50
28	17.00	16.36	14.50	13.50
30	18.00	17.36	15.50	14.50
32	19.00	18.36	16.50	15.50
38	22.00	21.36	19.50	18.50
40	23.00	22.36	20.50	19.50
48	27.00	26.36	24.50	23.50

# AYF53

## Y5BW RECOMMENDED FPC DIMENSIONS

(Finished thickness:  $t = 0.3 \pm 0.03$ )

The conductive parts should be based by Ni plating and then Au plating.

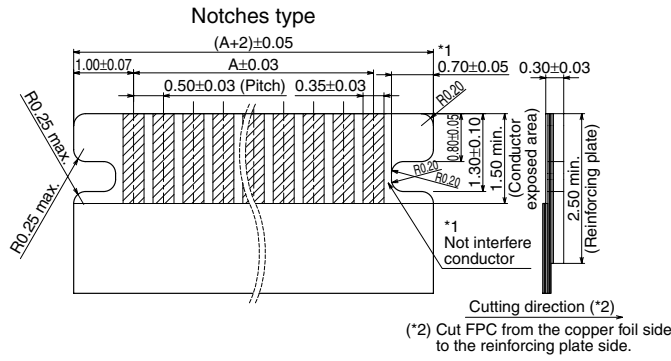

Number of pins/ dimension	A
2	0.50
3	1.00
4	1.50
6	2.50
8	3.50
10	4.50
12	5.50
14	6.50
22	10.50
26	12.50
28	13.50
30	14.50
32	15.50
38	18.50
40	19.50
48	23.50

## EMBOSSED TAPE DIMENSIONS (Unit: mm) (Common for respective contact type)

### • Specifications for taping

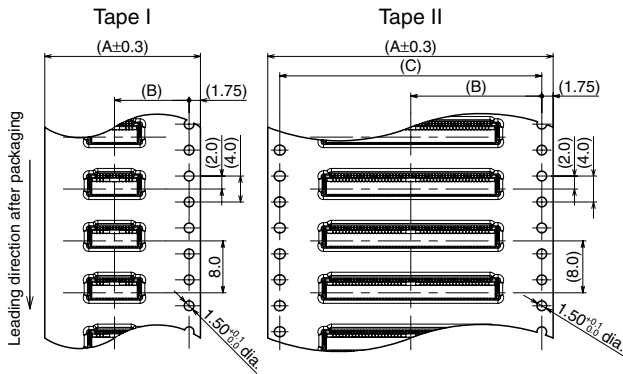

### • Specifications for the plastic reel

(In accordance with EIAJ ET-7200B.)

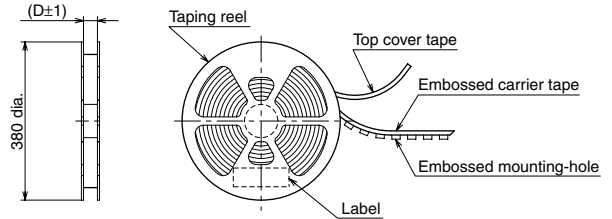

### • Y5B Dimension table (Unit: mm)

Number of pins	Type of taping	A	B	C	D	Quantity per reel
4 to 10	Tape I	16.0	7.5	—	17.4	5,000
12 to 30	Tape I	24.0	11.5	—	25.4	5,000
32 to 34	Tape II	32.0	14.2	28.4	33.4	5,000
40 to 50	Tape II	44.0	20.2	40.4	45.4	5,000

### • Y5BW Dimension table (Unit: mm)

Number of pins	Type of taping	A	B	C	D	Quantity per reel
2 to 8	Tape I	16.0	7.5	—	17.4	5,000
10 to 28	Tape I	24.0	11.5	—	25.4	5,000
30 to 32	Tape II	32.0	14.2	28.4	33.4	5,000
38 to 48	Tape II	44.0	20.2	40.4	45.4	5,000

### • Connector orientation with respect to embossed tape feeding direction

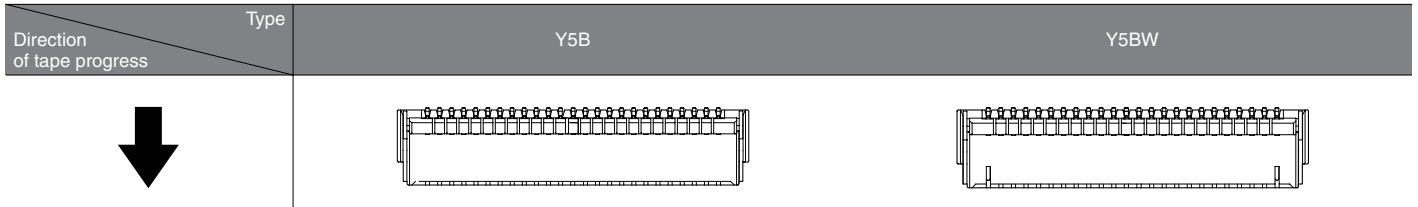

**NOTES**

**1. Recommended PC board and metal mask patterns**

Connectors are mounted with high pitch density, intervals of 0.3 mm or 0.5 mm. In order to reduce solder bridges and other issues make sure the proper levels of solder is used. The figures to the right are recommended metal mask patterns. Please use them as a reference.

**• Y5B/Y5BW**

Recommended PC board pattern (mounting layout) (TOP VIEW)

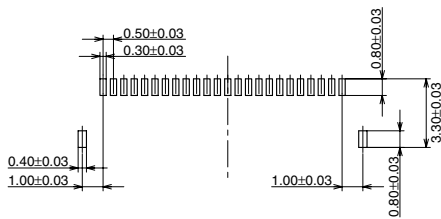

Recommended metal mask pattern

Metal mask thickness: Here, 120µm  
(Terminal portion opening area ratio: 31.8%)  
(Soldering terminal portion opening area ratio: 100%)

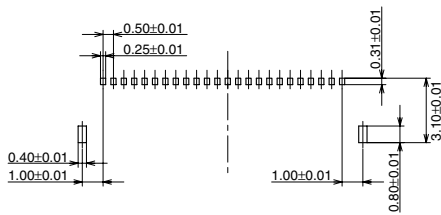

**2. Precautions for insertion/removal of FPC**

Do not apply an excessive load to the lever in the opening direction beyond its open position; otherwise, the lever may be deformed or removed. Do not open/close the lever without an FPC inserted; otherwise, the terminals may be deformed, and the FPC insertion force may increase. Do not apply an excessive load to the lever in a direction perpendicular to the lever rotation axis or in the lever opening direction; otherwise, the terminals may be deformed, and the lever may be removed.

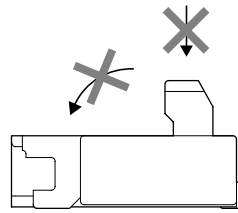

These connectors are of the back lock type, which has the FPC insertion section on the opposite side of the lever. Carefully place the FPC in the insertion position or the lever opening/closing position. Otherwise, a contact failure or connector breakage may occur. These connectors have top and bottom double contacts. Do not insert an FPC upside down. Inserting an FPC in a direction opposite to that you intended may cause an operation failure or malfunction. Fully open the lever to insert an FPC. Completely insert the FPC horizontally. An FPC inserted at an excessive angle to the board may cause the deformation of metal parts, FPC insertion failures, and FPC circuit breakages. Insert the FPC to the full depth of the connector without altering the angle.

To close the lever, turn down the lever by pressing the entire lever or both sides of the lever with fingers tips. If pressure to the lever is applied unevenly, such as to an edge only, it may deform or break. Also, make sure that the lever is closed completely. Not doing so will cause a faulty connection. Avoid applying an excessive load to the top of the lever during or after closing the lever. Otherwise, the terminals may be deformed. When opening the lever to remove the FPC, ensure that the lever will not go over the initial position; otherwise, the lever may be removed. Remove the FPC at parallel with the lever fully opened. If the lever is closed, or if the FPC is forcedly pulled, the product or FPC may break. If a lever is accidentally detached during the handling of a connector, do not use the connector any longer. After an FPC is inserted, carefully handle it so as not to apply excessive stress to the base of the FPC.

**3. Cautions for using Y5BW**

The holding contacts cannot be used as conductors. The holding contacts are located on both ends of the contacts, and the shape of the soldered portions is the same as that of the other contacts. Use caution to ensure connect identification.

Please refer to the latest product specifications when designing your product.

# Notes on Using FPC Connectors (Common)

## ■ PC board design

Design the recommended foot pattern in order to secure the mechanical strength in the soldered areas of the terminal.

## ■ FPC and equipment design

Design the FPC based with recommended dimensions to ensure the required connector performance.

When back lock type is used, secure enough space for closing the lever and for open-close operation of the lever.

Due to the FPC size, weight, or the reaction force of the routed FPC.

Carefully check the equipment design and take required measures to prevent the FPC from being removed due to a fall, vibration, or other impact.

## ■ Connector mounting

Excessive mounter chucking force may deform the molded or metal part of the connector. Consult us in advance if chucking is to be applied.

## ■ Soldering

1) Manual soldering.

• Due to the connector's compact size, if an excessive amount of solder is applied during manual soldering, the solder may creep up near the contact points, or solder interference may cause imperfect contact.

• Make sure that the soldering iron tip is heated within the temperature and time limits indicated in the specifications.

• Flux from the solder wire may adhere to the contact surfaces during soldering operations. After soldering, carefully check the contact surfaces and clean off any flux before use.

• Be aware that a load applied to the connector terminals while soldering may displace the contact.

• Thoroughly clean the iron tip.

2) Reflow soldering

• Screen-printing is recommended for printing paste solder.

• To achieve the appropriate soldering state, make sure that the reflow temperature, PC board foot pattern, window size and thickness of metal mask are recommended condition.

• Note that excess solder on the terminals prevents complete insertion of the FPC, and that excess solder on the soldering terminals prevents the lever from rotating.

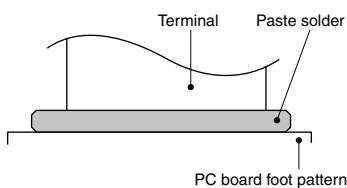

- Consult us when using a screen-printing thickness other than that recommended.
- Depending on the size of the connector being used, self alignment may not be possible. Accordingly, carefully position the terminal with the PC board pattern.
- The recommended reflow temperature profile is given in the figure below

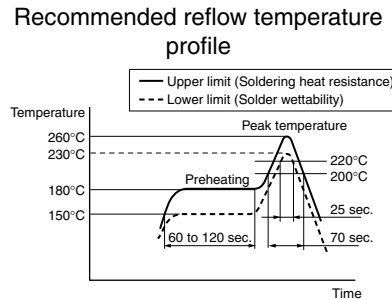

- The temperature is measured on the surface of the PC board near the connector terminal.
  - Certain solder and flux types may cause serious solder creeping. Solder and flux characteristics should be taken into consideration when setting the reflow soldering conditions.
  - When performing reflow soldering on the back of the PC board after reflow soldering the connector, secure the connector using, for example, an adhesive. (Double reflow soldering on the same side is possible)
- 3) Reworking on a soldered portion
- Finish reworking in one operation.
  - For reworking of the solder bridge, use a soldering iron with a flat tip. Do not add flux, otherwise the flux may creep to the contact parts.
  - Use a soldering iron whose tip temperature is within the temperature range specified in the specifications.

**■ Do not drop or handle the connector carelessly. Otherwise, the terminals may become deformed due to excessive force or applied solderability may be during reflow degrade.**

**■ Don't open/close the lever or insert/remove an FPC until the connector is soldered. Forcibly applied external pressure on the terminals can weaken the adherence of the terminals to the molded part or cause the terminals to lose their evenness. In addition, do not insert an FPC into the connector before soldering the connector.**

**■ When cutting or bending the PC board after mounting the connector, be careful that the soldered sections are subjected to excessive force.**

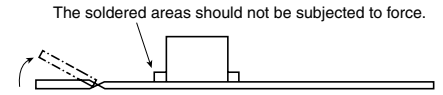

## ■ Other Notes

When coating the PC board after soldering the connector (to prevent the deterioration of insulation), perform the coating in such a way so that the coating does not get on the connector. The connectors are not meant to be used for switching.

Please refer to the latest product specifications when designing your product.