

# NCP583

## Ultra-Low Iq 150 mA CMOS LDO Regulator with Enable

The NCP583 series of low dropout regulators are designed for portable battery powered applications which require precise output voltage accuracy, low supply current, and high ripple rejection. These devices feature an enable function which lowers current consumption significantly and are offered in two small packages; SC-82AB and the SOT-563.

A 1.0  $\mu\text{F}$  ceramic capacitor is the recommended value to be used with these devices on the output pin.

### Features

- Ultra-Low Dropout Voltage of 250 mV at 150 mA
- Low Quiescent Current of 0.1  $\mu\text{A}$
- Excellent Line and Load Regulation
- High Output Voltage Accuracy of  $\pm 2\%$
- Ultra-Low Supply Current of 1.0  $\mu\text{A}$
- Excellent Power Supply Rejection Ratio
- Wide Operating Voltage of 1.5 V to 3.3 V
- Low Temperature Drift Coefficient on the Output Voltage
- Fold Back Protection Circuit
- These are Pb-Free Devices

### Typical Applications

- Portable Equipment
- Hand-Held Instrumentation
- Camcorders and Cameras

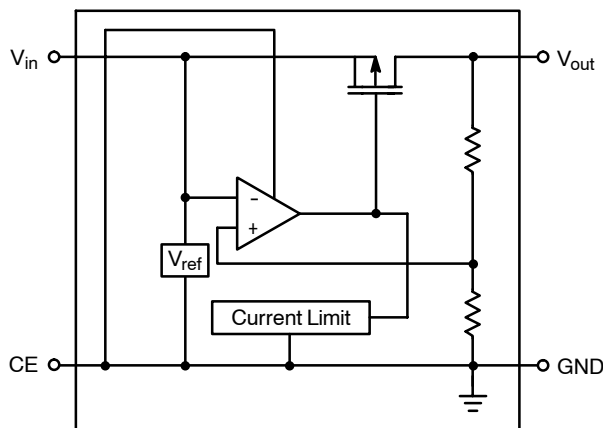

Figure 1. Simplified Block Diagram



ON Semiconductor®

<http://onsemi.com>

### MARKING DIAGRAMS

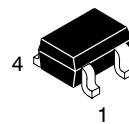

SC-82AB  
SQ SUFFIX  
CASE 419C

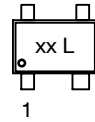

xx = Specific Device Code  
L = Lot Code

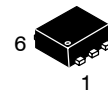

SOT-563  
XV SUFFIX  
CASE 463A



xxxx = Specific Device Code  
LL = Lot Code

### ORDERING INFORMATION

See detailed ordering and shipping information in the package dimensions section on page 674 of this data sheet.

# NCP583

## PIN FUNCTION DESCRIPTION

SOT-563 Pin	SC-82AB Pin	Symbol	Description
1	4	$V_{in}$	Power supply input voltage.
2	2	GND	Power supply ground.
3	3	$V_{out}$	Regulated output voltage.
4	–	NC	No connect.
5	–	GND	Power supply ground.
6	1	CE	Chip enable pin.

## MAXIMUM RATINGS

Rating	Symbol	Value	Unit
Input Voltage	$V_{in}$	6.5	V
Input Voltage ( $\overline{CE}$ or CE Pin)	$V_{CE}$	6.5	V
Output Voltage	$V_{out}$	-0.3 to $V_{in} + 0.3$	V
Output Current	$I_{out}$	180	mA
Power Dissipation SC-82AB SOT-563	$P_D$	150 500	mW
Operating Junction Temperature Range	$T_J$	-40 to +85	°C
Storage Temperature Range	$T_{stg}$	+150	°C

Maximum ratings are those values beyond which device damage can occur. Maximum ratings applied to the device are individual stress limit values (not normal operating conditions) and are not valid simultaneously. If these limits are exceeded, device functional operation is not implied, damage may occur and reliability may be affected.

## ELECTRICAL CHARACTERISTICS ( $V_{in} = V_{out} + 1.0$ V, $T_A = 25^\circ\text{C}$ , unless otherwise noted.)

Characteristic	Symbol	Min	Typ	Max	Unit
Input Voltage	$V_{in}$	1.7	–	6.0	V
Output Voltage ( $1.0 \mu\text{A} \leq I_{out} \leq 30$ mA)	$V_{out}$	$V_{out} \times 0.980$	–	$V_{out} \times 1.020$	V
Line Regulation ( $I_{out} = 30$ mA) ( $V_{out} > 1.5$ V; $V_{out} + 0.5$ V $\leq V_{in} \leq 6.0$ V) ( $1.2$ V $\leq V_{out} \leq 1.4$ V; $2.0$ V $\leq V_{in} \leq 6.0$ V)	$Reg_{line}$	–	0.05	0.20	%/V
Load Regulation ( $1.0 \mu\text{A} \leq I_{out} \leq 100$ mA)	$Reg_{load}$	–	20	40	mV
Dropout Voltage ( $I_{out} = 150$ mA) $V_{out} = 1.5$ V $V_{out} = 1.8$ V $V_{out} = 2.5$ V $2.8$ V $\leq V_{out} \leq 3.3$ V	$V_{DO}$	–	0.60 0.50 0.35 0.25	0.90 0.75 0.55 0.40	V
Power Supply Current ( $I_{out} = 0$ mA)	$I_{supply}$	–	1.0	1.5	$\mu\text{A}$
Output Current	$I_{out}$	150	–	–	mA
Quiescent Current ( $V_{CE} = \text{Gnd}$ )	$I_Q$	–	0.1	1.0	$\mu\text{A}$
Output Short Circuit Current ( $V_{out} = 0$ )	$I_{lim}$	–	40	–	mA
Enable Input Threshold Voltage High Low	$V_{th_{enh}}$ $V_{th_{enl}}$	1.2 0	– –	6.0 0.3	V

TYPICAL CHARACTERISTICS

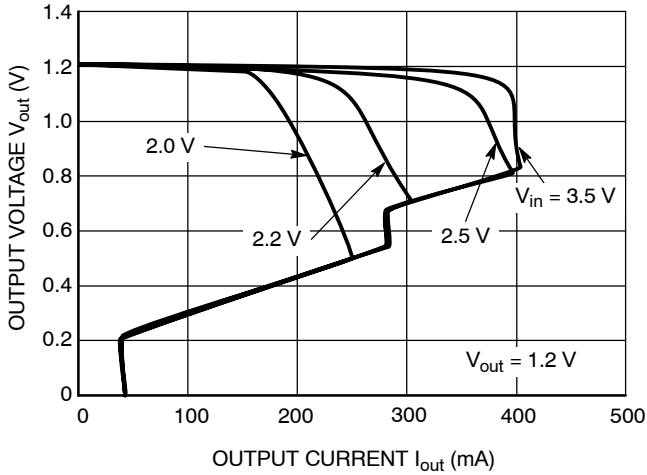

Figure 2. Output Voltage vs. Output Current

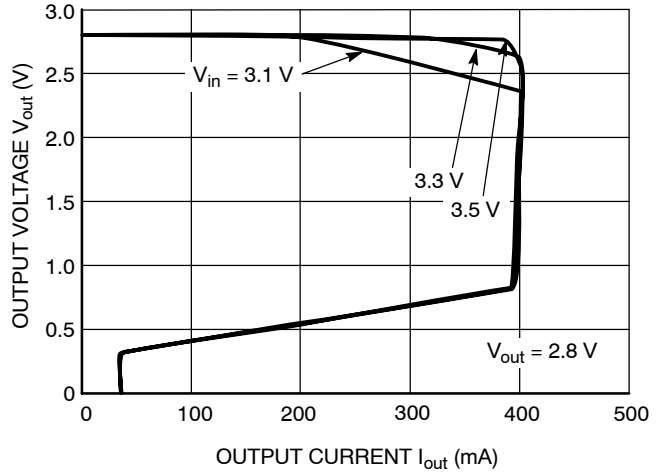

Figure 3. Output Voltage vs. Output Current

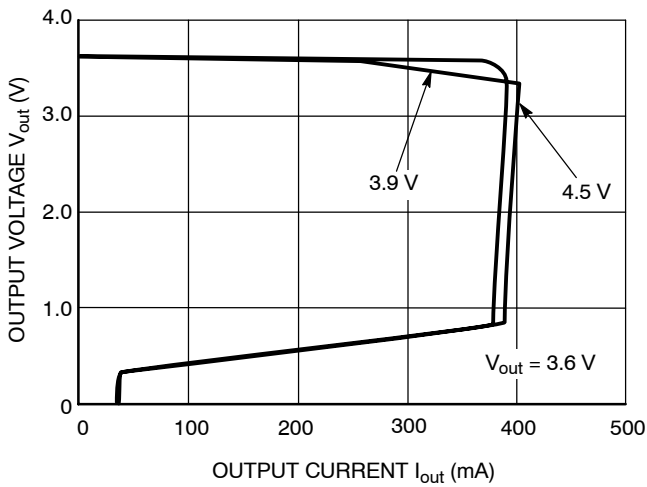

Figure 4. Output Voltage vs. Output Current

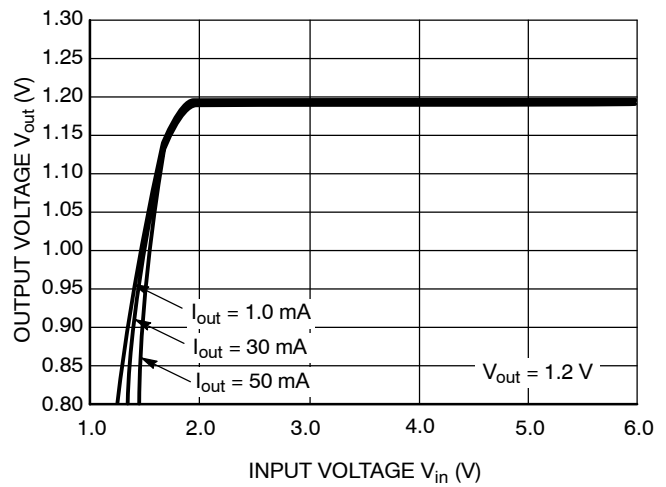

Figure 5. Output Voltage vs. Input Voltage

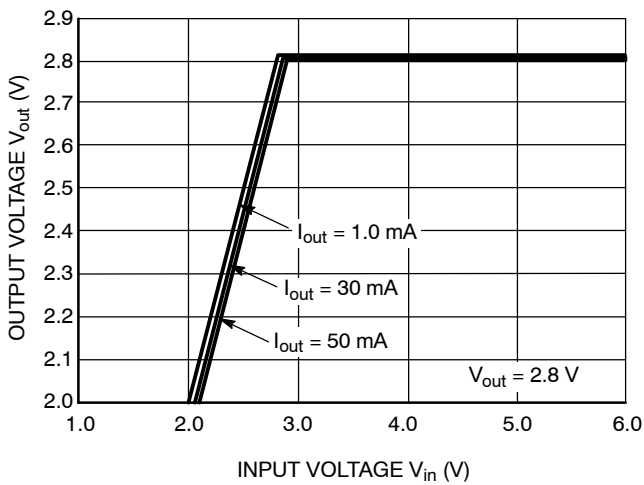

Figure 6. Output Voltage vs. Input Voltage

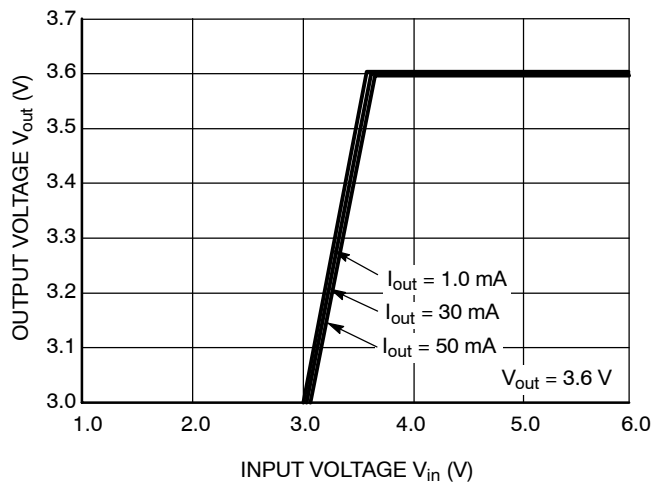

Figure 7. Output Voltage vs. Input Voltage

TYPICAL CHARACTERISTICS

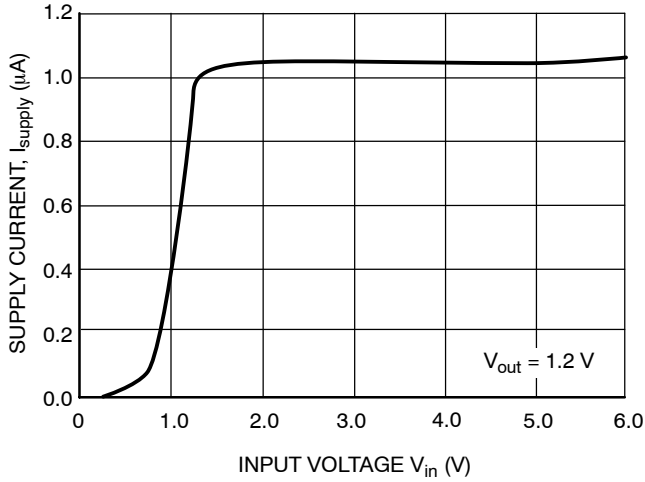

Figure 8. Power Supply Current vs. Input Voltage

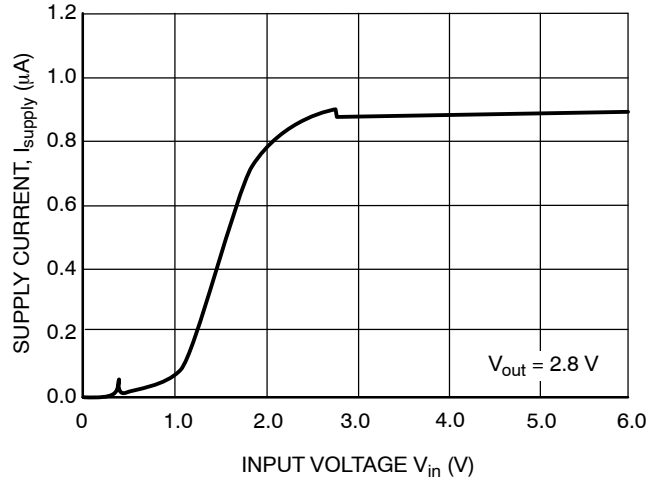

Figure 9. Power Supply Current vs. Input Voltage

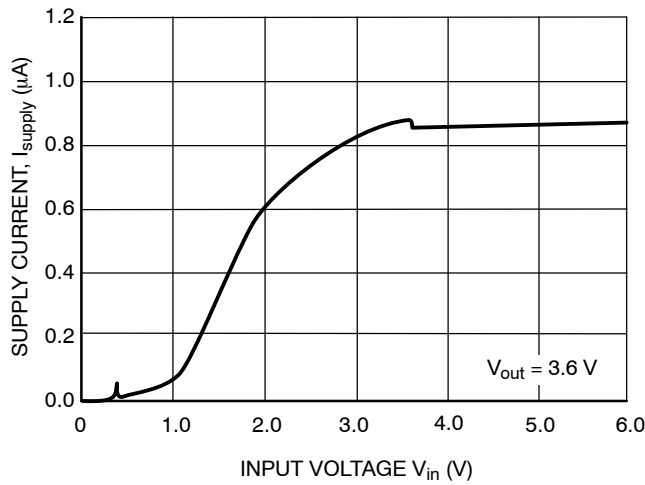

Figure 10. Power Supply Current vs. Input Voltage

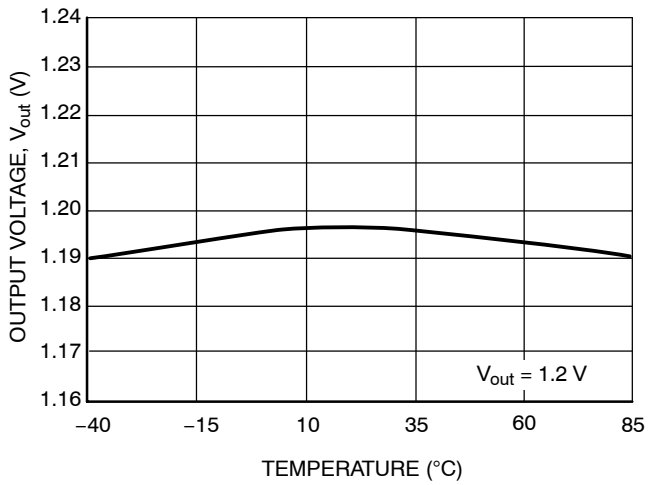

Figure 11. Output Voltage vs. Temperature

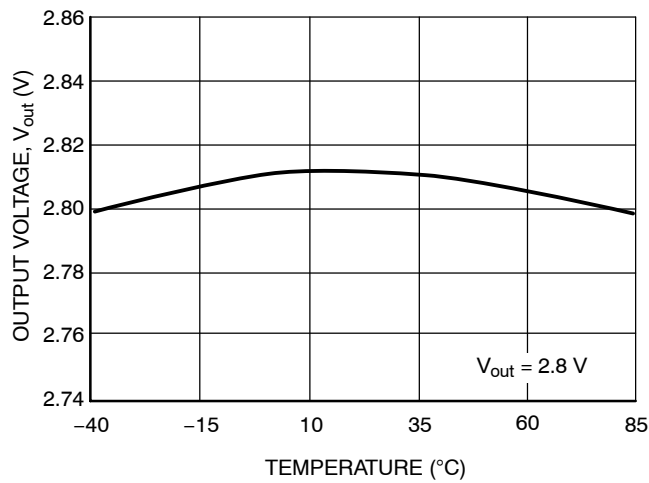

Figure 12. Output Voltage vs. Temperature

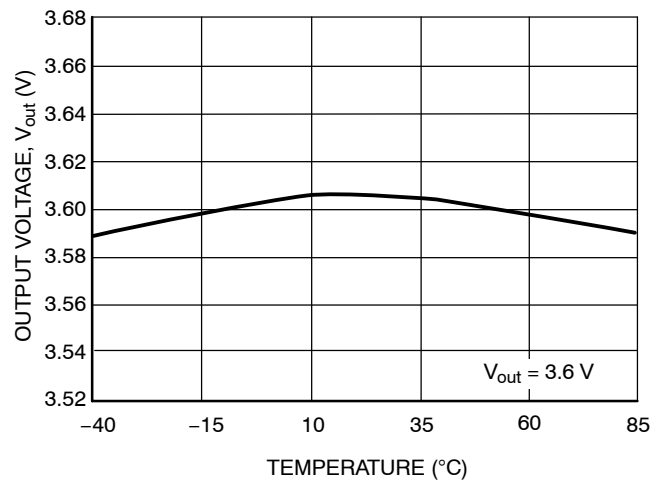

Figure 13. Output Voltage vs. Temperature

# NCP583

## TYPICAL CHARACTERISTICS

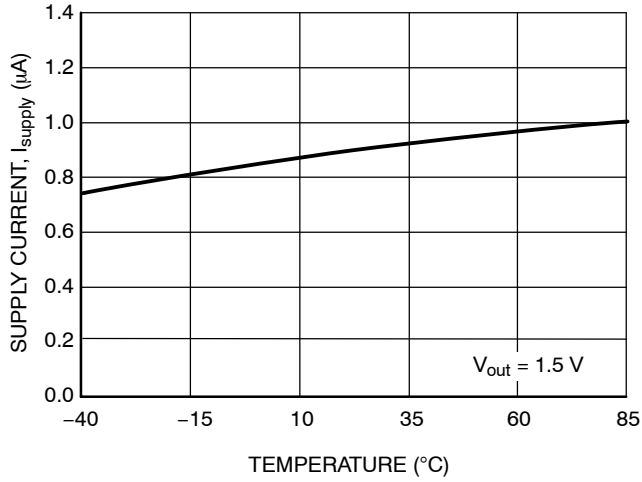

Figure 14. Power Supply Current vs. Temperature

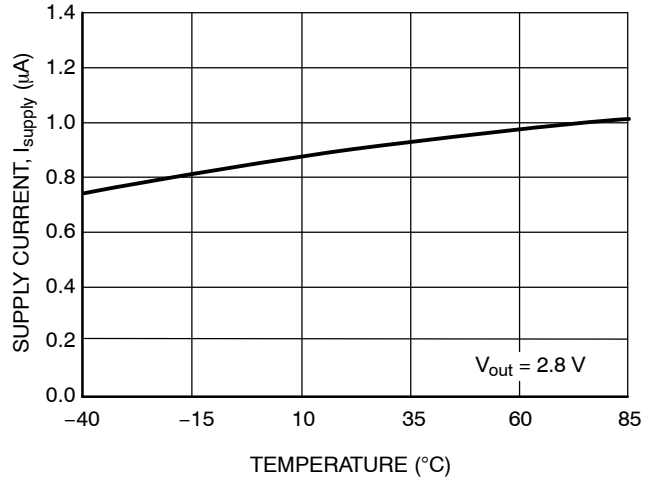

Figure 15. Power Supply Current vs. Temperature

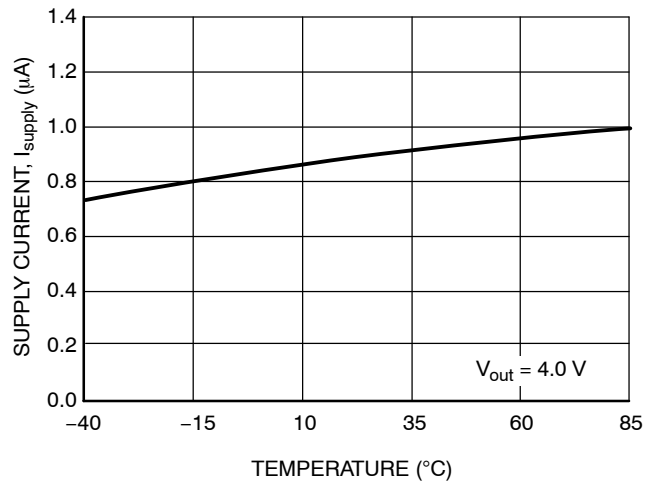

Figure 16. Power Supply Current vs. Temperature

TYPICAL CHARACTERISTICS

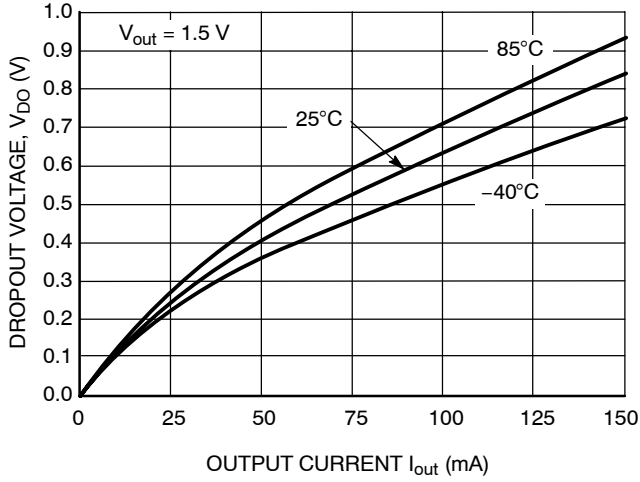

Figure 17. Dropout Voltage vs. Output Current

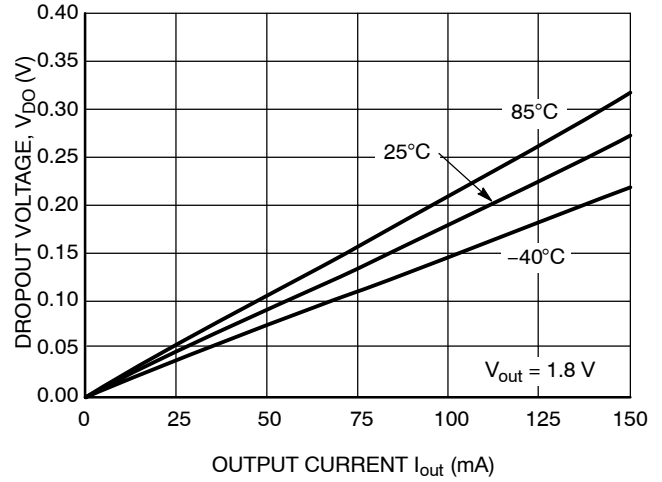

Figure 18. Dropout Voltage vs. Output Current

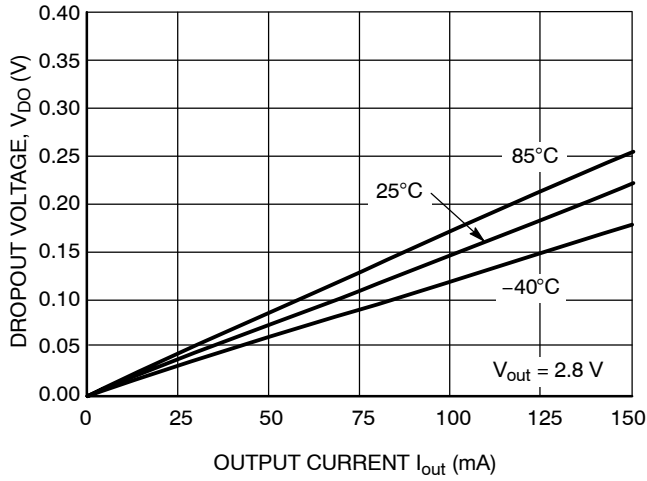

Figure 19. Dropout Voltage vs. Output Current

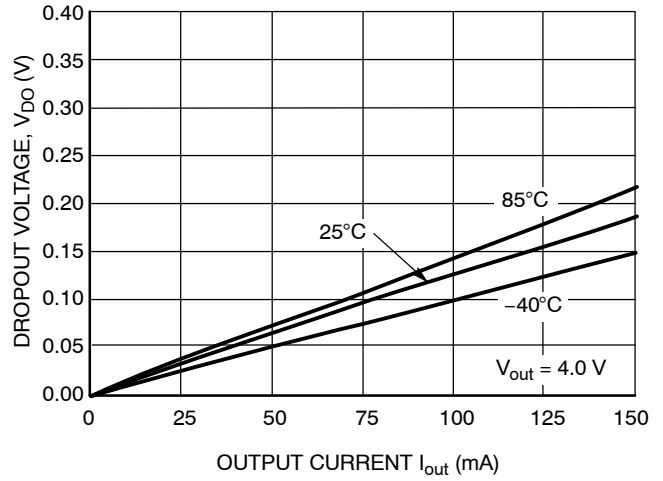

Figure 20. Dropout Voltage vs. Output Current

TYPICAL CHARACTERISTICS

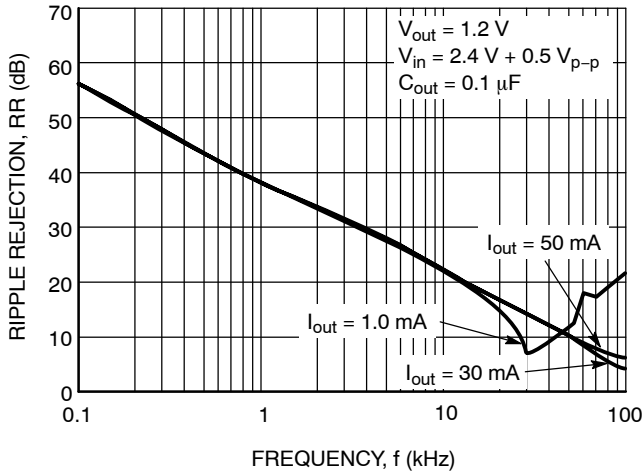

Figure 21. Ripple Rejection vs. Frequency

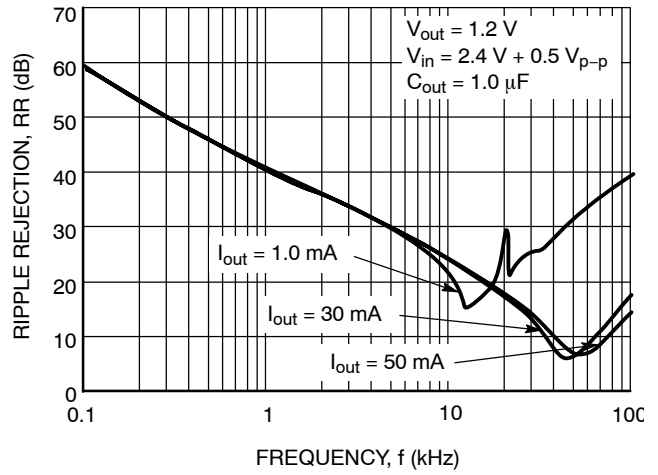

Figure 22. Ripple Rejection vs. Frequency

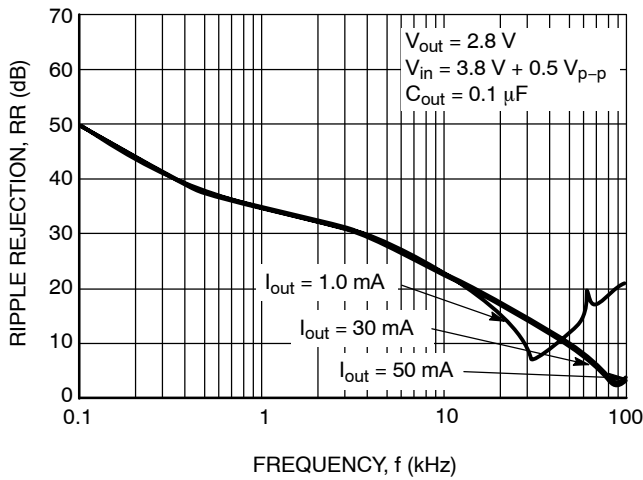

Figure 23. Ripple Rejection vs. Frequency

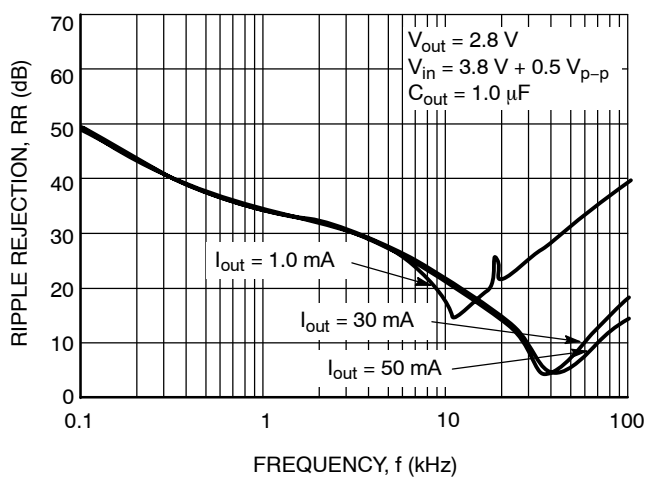

Figure 24. Ripple Rejection vs. Frequency

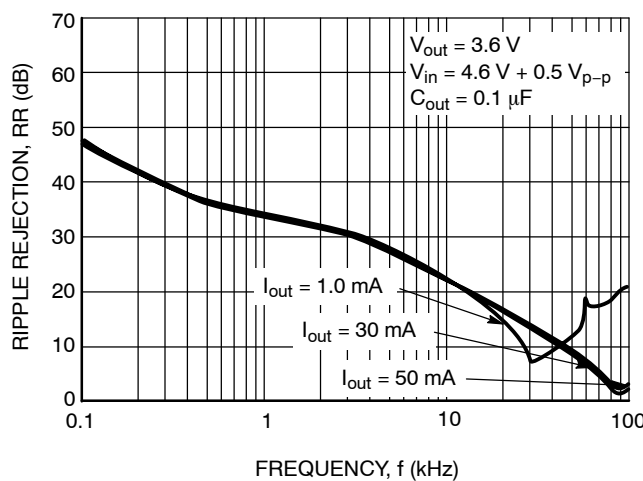

Figure 25. Ripple Rejection vs. Frequency

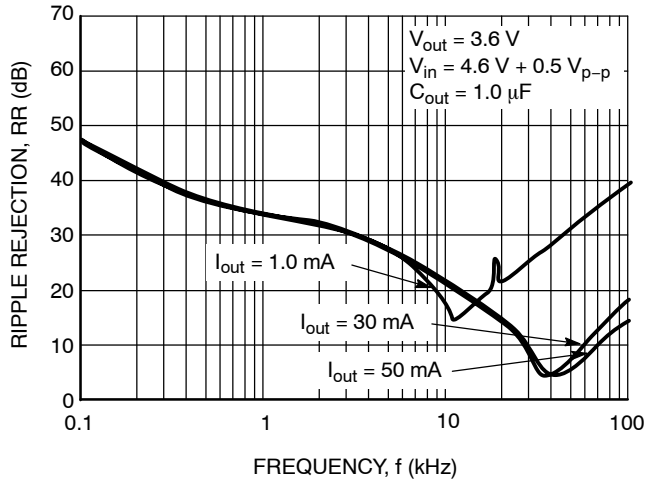
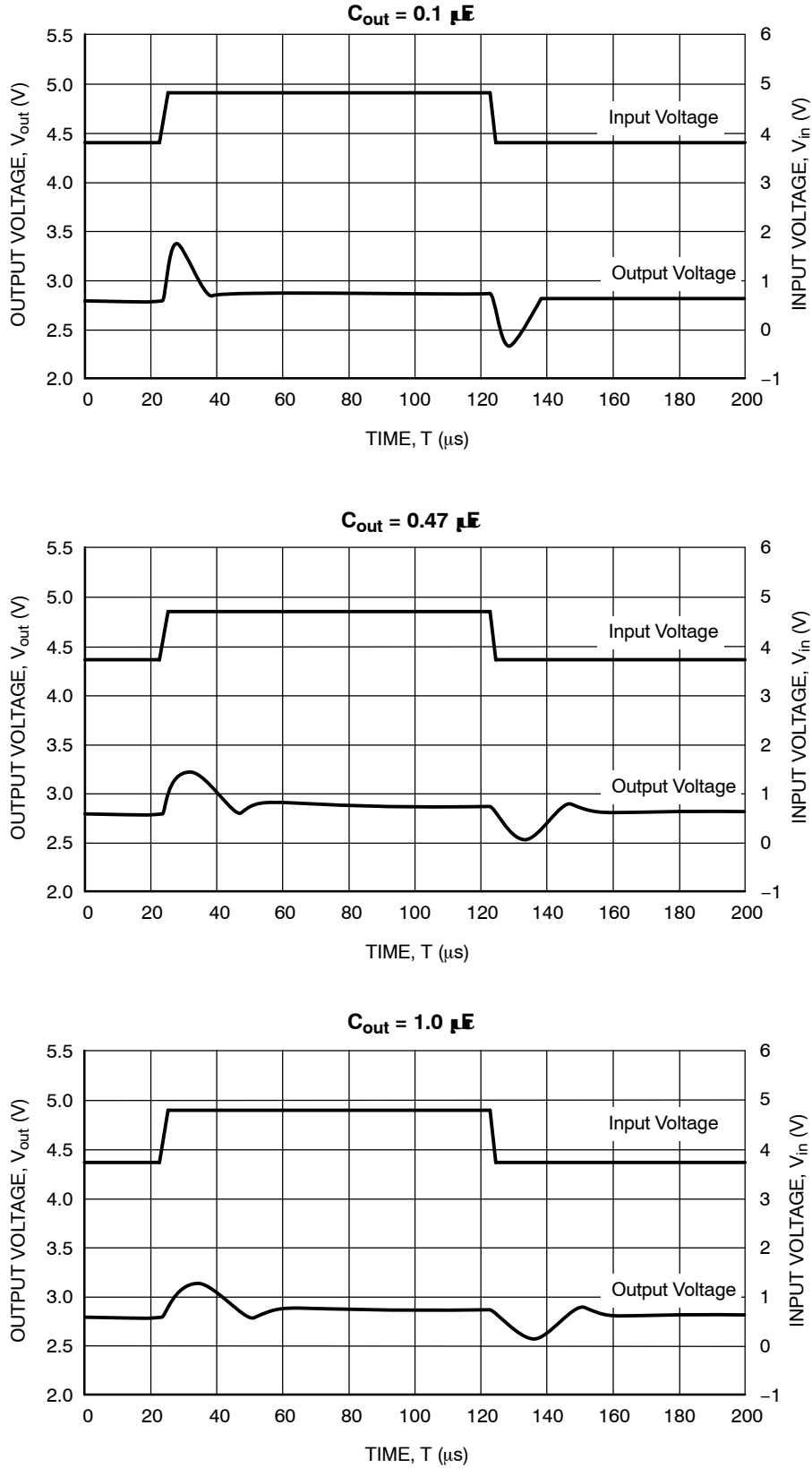

Figure 26. Ripple Rejection vs. Frequency

# NCP583

## TYPICAL CHARACTERISTICS

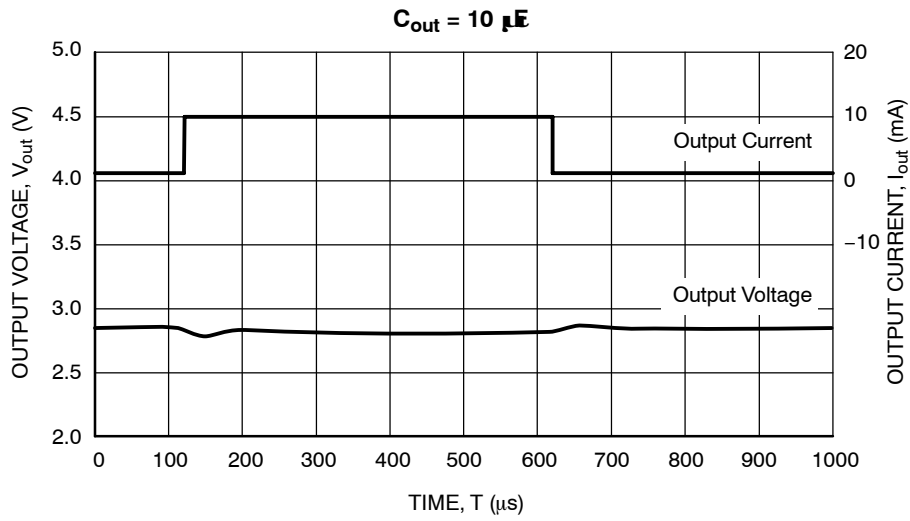
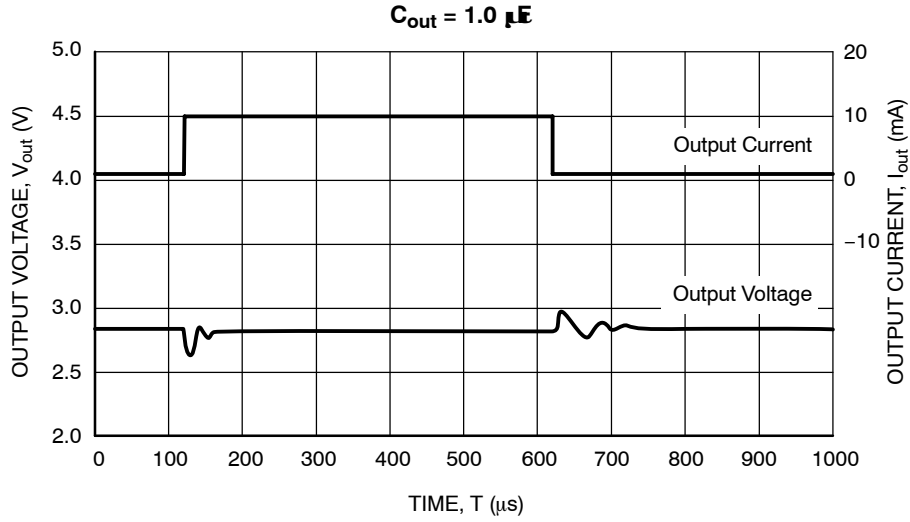

**Figure 27. Input Transient Response**  
( $V_{out} = 2.8 V$ ,  $I_{out} = 30 mA$ ,  $t_r = t_f = 5.0 \mu s$ ,  $C_{in} = 0$ )



# NCP583

## TYPICAL CHARACTERISTICS



**Figure 28. Load Transient Response**  
( $V_{out} = 2.8 V$ ,  $t_r = t_f = 5.0 \mu s$ ,  $V_{in} = 3.8 V$ )

# NCP583

## TYPICAL CHARACTERISTICS

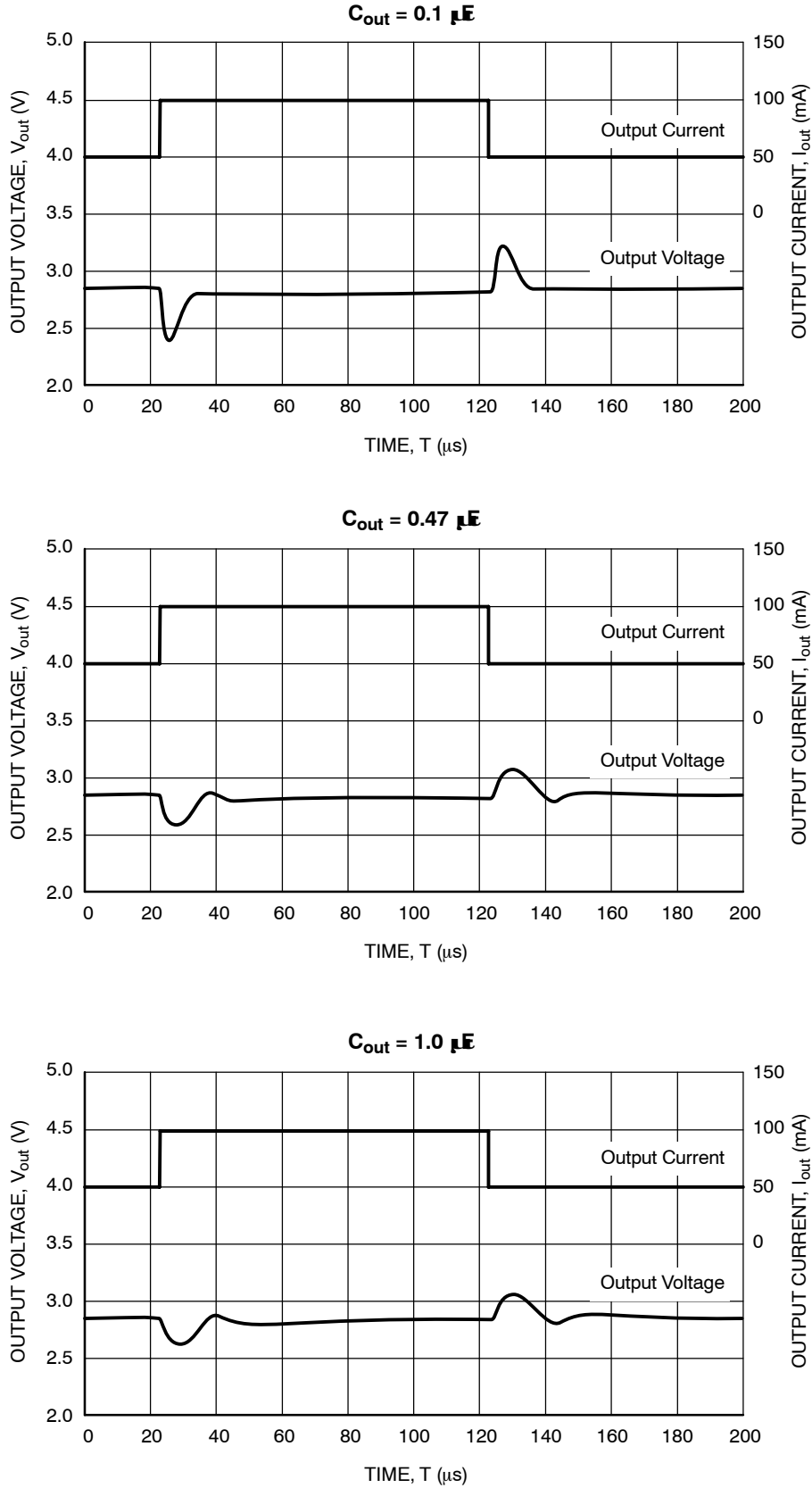

**Figure 29. Load Transient Response**  
( $V_{out} = 2.8$  V,  $t_r = t_f = 5.0 \mu s$ ,  $V_{in} = 3.8$  V)

# NCP583

## APPLICATION INFORMATION

### Input Decoupling

A 1.0  $\mu$ F ceramic capacitor is the recommended value to be connected between  $V_{in}$  and GND. For PCB layout considerations, the traces of  $V_{in}$  and GND should be sufficiently wide in order to minimize noise and prevent unstable operation.

### Output Decoupling

It is recommended to use a 0.1  $\mu$ F ceramic capacitor on the  $V_{out}$  pin. For better performance, select a capacitor with low Equivalent Series Resistance (ESR). For PCB layout considerations, place the output capacitor close to the output pin and keep the leads short as possible.

## ORDERING INFORMATION

Device	Output Type / Features	Nominal Output Voltage	Marking	Package	Shipping
NCP583SQ15T1G	Active High w/Enable	1.5	A5	SC-82AB (Pb-Free)	3000 Tape & Reel
NCP583SQ18T1G	Active High w/Enable	1.8	A8	SC-82AB (Pb-Free)	3000 Tape & Reel
NCP583SQ25T1G	Active High w/Enable	2.5	B5	SC-82AB (Pb-Free)	3000 Tape & Reel
NCP583SQ28T1G	Active High w/Enable	2.8	B8	SC-82AB (Pb-Free)	3000 Tape & Reel
NCP583SQ30T1G	Active High w/Enable	3.0	C0	SC-82AB (Pb-Free)	3000 Tape & Reel
NCP583SQ33T1G	Active High w/Enable	3.3	C3	SC-82AB (Pb-Free)	3000 Tape & Reel
NCP583XV15T1G*	Active High w/Enable	1.5	G15B	SOT-563 (Pb-Free)	4000 Tape & Reel
NCP583XV18T1G*	Active High w/Enable	1.8	G18B	SOT-563 (Pb-Free)	4000 Tape & Reel
NCP583XV25T1G*	Active High w/Enable	2.5	G25B	SOT-563 (Pb-Free)	4000 Tape & Reel
NCP583XV28T1G*	Active High w/Enable	2.8	G28B	SOT-563 (Pb-Free)	4000 Tape & Reel
NCP583XV29T1G*	Active High w/Enable	2.9	G29B	SOT-563 (Pb-Free)	4000 Tape & Reel
NCP583XV30T1G*	Active High w/Enable	3.0	G30B	SOT-563 (Pb-Free)	4000 Tape & Reel
NCP583XV33T1G*	Active High w/Enable	3.3	G33B	SOT-563 (Pb-Free)	4000 Tape & Reel

\*Samples and production start 1Q05.