

Triple-Balanced Mixer

MY50A/MY50AC

V2

Features

- LO 2 TO 26 GHz
- RF 2 TO 18 GHz
- IF 1 TO 12 GHz
- LO DRIVE +10 dBm (nominal)
- HIGH COMPRESSION POINT

Description

MY50A is a triple balanced mixer, designed for use in military, commercial and test equipment applications. The design utilizes Schottky ring quad diodes and broadband soft dielectric baluns to attain excellent performance. The use of high temperature solder assembly processes used internally makes it ideal for use in manual, semi-automated assembly. Environmental screening available to MIL-STD-883, MIL-STD-202 or MIL-DTL-28837, consult factory.

Product Image

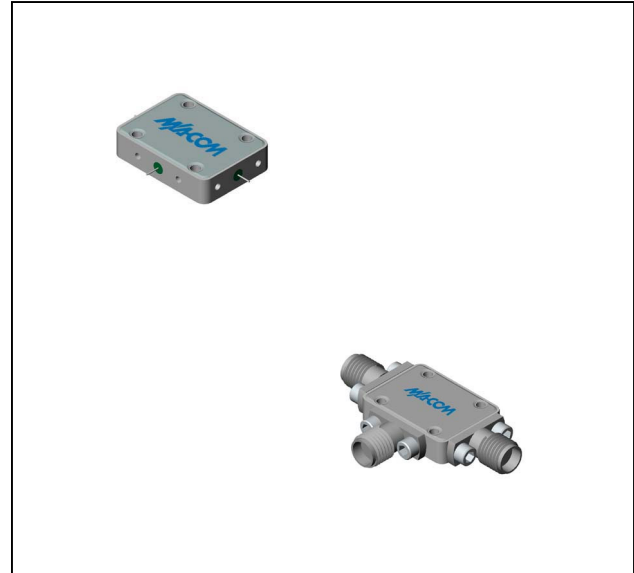

Ordering Information

Part Number	Package
MY50A	Versapac
MY50AC	SMA Connectorized

Electrical Specifications: $Z_0 = 50\Omega$ $Lo = +10$ dBm (Downconverter Application only)

Parameter	Test Conditions	Units	Typical	Guaranteed	
				+25°C	-54° to +85°C
SSB Conversion Loss (max) & SSB Noise Figure (max)	fR = 2.5 to 18 GHz, fL = 2 to 18 GHz, fI = 1 to 10 GHz fR = 2 to 18 GHz, fL = 2 to 26 GHz, fI = 1 to 12 GHz	dB dB	7.5	9.5	10.0
			8.0	10.5	11.0
Isolation, L to R (min)	fL = 2 to 3 GHz fL = 3 to 26 GHz	dB dB	22	15	
			30	20	
Isolation, L to I (min)	fL = 7 to 26 GHz fL = 2 to 7 GHz	dB dB	30	20	
			22	15	
1 dB Conversion Comp.	fL = +10 dBm	dBm	+5		
Input IP3	fR1 = 5 GHz at -6 dBm, fR2 = 5.01 GHz at -6 dBm, fL = 8 GHz at +10 dBm fR1 = 15 GHz at -6 dBm, fR2 = 15.01 GHz at -6 dBm, fL = 25 GHz at +10 dBm	dBm dBm	+15		
			+12		

Triple-Balanced Mixer

MY50A/MY50AC

V2

Typical Performance Curves

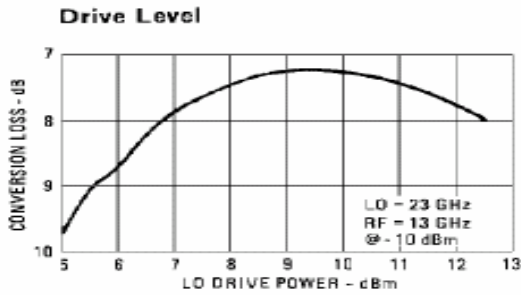

Isolation vs. Frequency

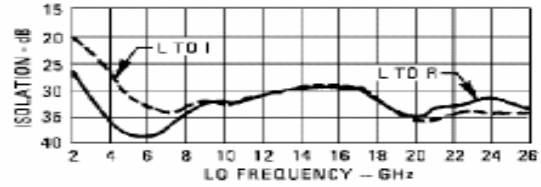

**Conversion Loss vs. Frequency
LO @ +10 dBm**

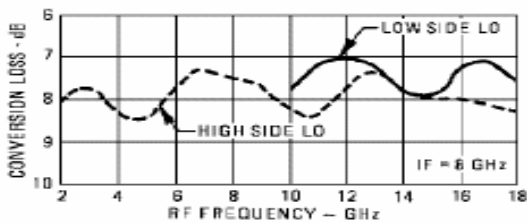
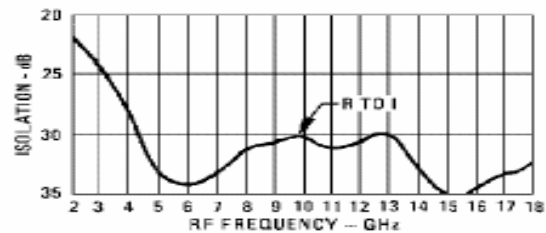
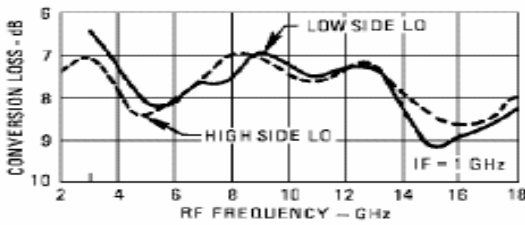

L-Port VSWR

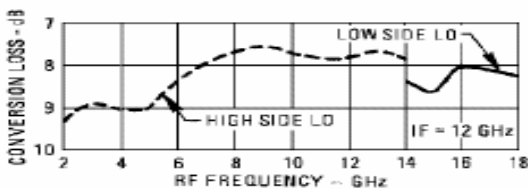
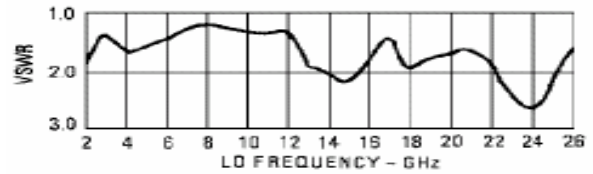

R-Port VSWR

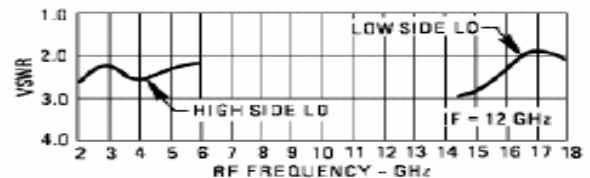

Triple-Balanced Mixer

MY50A/MY50AC

V2

Absolute Maximum Ratings

Parameter	Absolute Maximum
Operating Temperature	-54°C to +100°C
Storage Temperature	-65°C to +100°C
Peak Input Power	+26 dBm max @ +25°C +22 dBm max @ +100°C
Peak Input Current	mA DC

I-Port VSWR vs. Frequency, LO @ +10 dBm

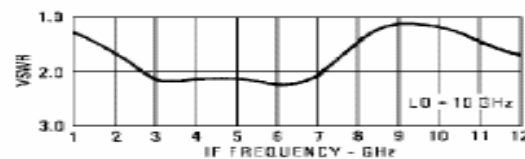
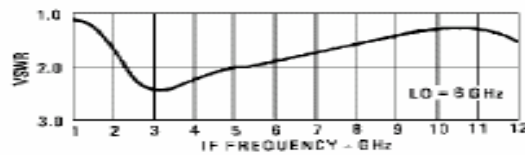
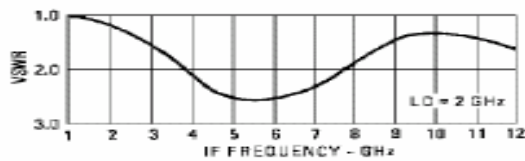

I-Port VSWR

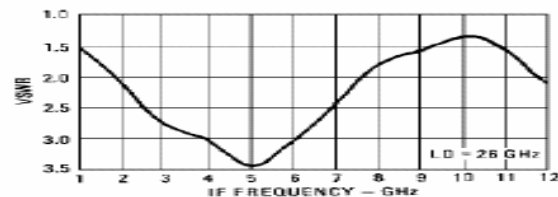
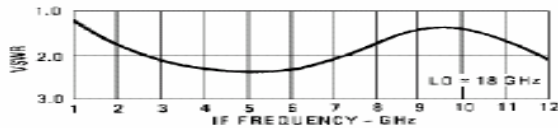
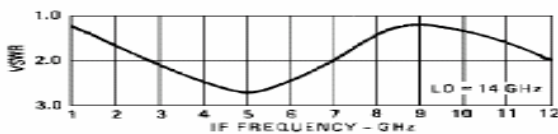

Outline Drawing: Versapac *

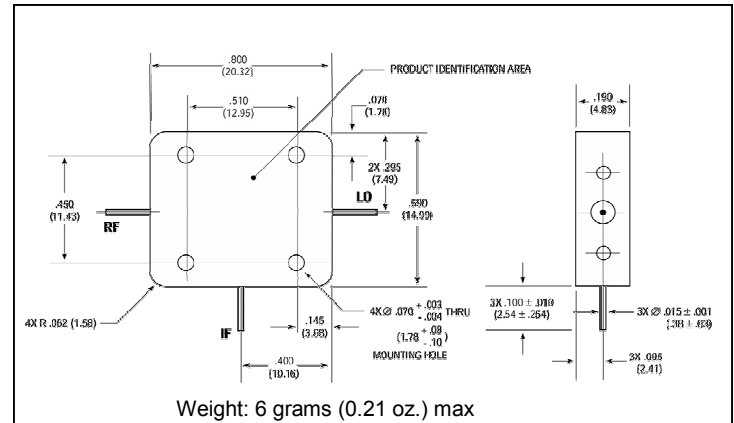

Outline Drawing: SMA Connectorized *

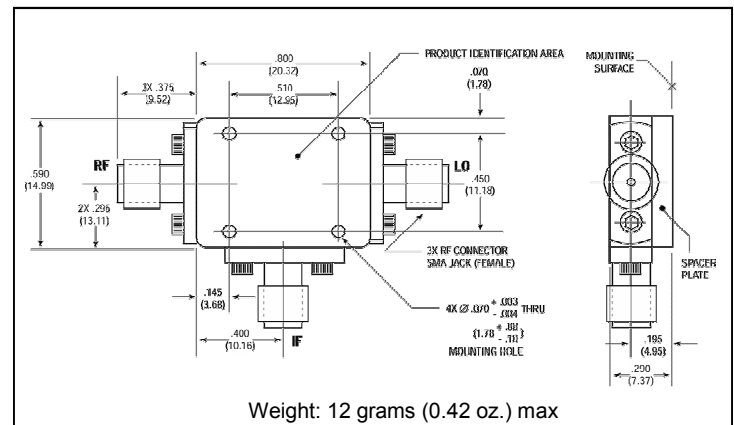

* Dimensions are inches (millimeters) ±0.015 (0.38) unless otherwise specified.