

FAN4852

9MHz Low-Power Dual CMOS Amplifier

Features

- 0.8mA Supply Current
- 9 MHz Bandwidth
- Output Swing to within 10mV of Either Rail
- Input Voltage Range Exceeds the Rails
- 6V/μs Slew Rate
- 11nV/√Hz Input Voltage Noise
- Fully Specified at +3.3V and +5V Supplies

Applications

- Piezoelectric Sensors
- PCMCIA, USB
- Mobile Communications / Battery-Powered Devices
- Notebooks and PDAs
- Active Filters
- Signal Conditioning
- Portable Test Instruments

Description

The FAN4852 is a dual, rail-to-rail output, low-power, CMOS amplifier that consumes only 800μA of supply current, while providing ±50mA of output short-circuit current. This amplifier is designed to operate supplies from 2.5V to 5V.

Additionally, the FAN4852 is EMI hardened, which minimizes EMI interference. It has a maximum input offset voltage of 1mV and an input common-mode range that includes ground.

The FAN4852 is designed on a CMOS process and provides 9MHz of bandwidth and 6V/μs of slew rate. The combination of low-power, low-voltage operation and a small package make this amplifier well suited for general-purpose and battery-powered applications.

Ordering Information

Part Number	Operating Temperature Range	Package	Packing Method
FAN4852IMU8X	-40 to +85°C	8-Lead MSOP Package	3000 on Tape and Reel

Pin Configuration

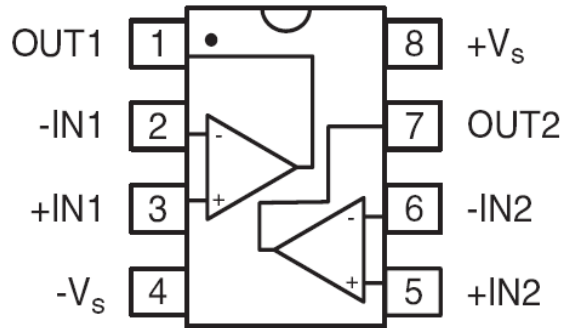

Figure 1. Pin Assignments

Pin Definitions

Pin #	Name	Description
1	OUT1	Output, Channel 1
2	-IN1	Negative Input, Channel 1
3	+IN1	Positive Input, Channel 1
4	-Vs	Negative Supply
5	+IN2	Positive Input, Channel 2
6	-IN2	Negative Input, Channel 2
7	OUT2	Output, Channel 2
8	+Vs	Positive Supply

Absolute Maximum Ratings

Stresses exceeding the absolute maximum ratings may damage the device. The device may not function or be operable above the recommended operating conditions and stressing the parts to these levels is not recommended. In addition, extended exposure to stresses above the recommended operating conditions may affect device reliability. The absolute maximum ratings are stress ratings only. Functional operation under any of these conditions is NOT implied. Performance and reliability are guaranteed only if operating conditions are not exceeded.

Symbol	Parameter	Min.	Max.	Unit
V _{CC}	Supply Voltage	0	6	V
V _{IN}	Input Voltage Range	-V _S -0.5	+V _S +0.5	V
T _J	Junction Temperature		+150	°C
T _{STG}	Storage Temperature	-65	+150	°C
T _L	Lead Soldering, 10 Seconds		+260	°C
Θ _{JA}	Thermal Resistance ⁽¹⁾		206	°C/W

Note:

1. Package thermal resistance JEDEC standard, multi-layer test boards, still air.

ESD Information

Symbol	Parameter	Min.	Typ.	Max.	Unit
ESD	Human Body Model, JESD22-A114		8		kV
	Charged Device Model, JESD22-C101		2		

Recommended Operating Conditions

The Recommended Operating Conditions table defines the conditions for actual device operation. Recommended operating conditions are specified to ensure optimal performance to the datasheet specifications. Fairchild does not recommend exceeding them or designing to Absolute Maximum Ratings.

Symbol	Parameter	Min.	Typ.	Max.	Unit
T _A	Operating Temperature Range	-40		+85	°C
V _s	Supply Voltage Range	2.5	3.3	5.0	V

Electrical Specifications at +3.3V

+V_S=+3.3V, -V_S = 0V, V_{CM} = +V_S/2, and R_L = 10KΩ to +V_S/2, unless otherwise noted.

Symbol	Parameter	Condition	Min.	Typ.	Max.	Unit
I _S	Supply Current ⁽²⁾	T _A =25°C		0.8	1.0	mA
		Full Temperature Range			1.1	
I _{SC}	Short-Circuit Output Current ⁽²⁾	Sourcing V _O =V _{CM} , V _{IN} =100mV, T _A =25°C	25	50		mA
		Sourcing V _O =V _{CM} , V _{IN} =100mV, Full Temperature Range	20			
		Sinking V _O =V _{CM} , V _{IN} =-100mV, T _A =25°C	28	46		
		Sinking V _O =V _{CM} , V _{IN} =-100mV, Full Temperature Range	20			
EMIRR	EMI Rejection Ratio, +IN and -IN ⁽⁴⁾	V _{RFpeak} =100mVp, (-20dBVp) f=400MHz		75		dB
		V _{RFpeak} =100mVp, (-20dBVp) f=900MHz		78		
		V _{RFpeak} =100mVp, (-20dBVp) f=1800MHz		87		
PSRR	Power Supply Rejection Ratio ⁽²⁾	2.7V≤V+≤3.3V, V _O =1V, T _A =25°C	75	95		dB
		2.7V≤V+≤3.3V, V _O =1V, Full Temperature Range	74			
CMRR	Common Mode Rejection Ratio ⁽²⁾	-0.2V<V _{CM} <V+1.2V, T _A =25°C	76	117		dB
		-0.2V<V _{CM} <V+1.2V, Full Temperature Range	75			
CMIR	Input Common Mode Voltage Range ⁽²⁾	CMRR≥76dB	-0.2		2.1	V
V _{OS}	Input Offset Voltage ⁽²⁾	T _A =25°C		±0.3	±1.0	mV
		Full Temperature Range			±1.2	
dV _{IO}	Average Drift ⁽³⁾			±0.4	±2.0	μV/°C
I _{OS}	Input Offset Current			1		pA
		T _A =				
I _{bn_Char}	Input Bias Current ⁽³⁾	T _A =25°C		0.1	10.0	pA
		Full Temperature Range			500	
e _n	Input-Referred Voltage Noise	f=1kHz		11		nV/√Hz
		f=10kHz		10		
i _n	Input-Referred Current Noise	f=1kHz		0.005		pA/√Hz

Continued on the following page...

Electrical Specifications at +3.3V

+V_S=+3.3V, -V_S = 0V, V_{CM} = +V_S/2, and R_L = 10kΩ to +V_S/2, unless otherwise noted.

Symbol	Parameter	Condition	Min.	Typ.	Max.	Unit	
V _O	Output Voltage Swing High ⁽²⁾ V _O = (+V _S) - V _{OUT}	R _L =2kΩ to V+/2, T _A =25°C		21	35	mV	
		R _L =2kΩ to V+/2, Full Temperature Range			43		
		R _L =10kΩ to V+/2, T _A =25°C		4	10		
		R _L =10kΩ to V+/2, Full Temperature Range			12		
	Output Voltage Swing Low ⁽²⁾ V _O = V _{OUT} + (-V _S)	R _L =2kΩ to V+/2, T _A =25°C			20	32	mV
		R _L =2kΩ to V+/2, Full Temperature Range				43	
		R _L =10kΩ to V+/2, T _A =25°C		3	11		
		R _L =10kΩ to V+/2, Full Temperature Range				14	
GBW	Gain Bandwidth Product			9		MHz	
A _{VOL}	Large Signal Voltage Gain ⁽³⁾	R _L =2kΩ, V _O =0.15 to 1.65V, V _O =3.15 to 1.65V, T _A =25°C	100	114		dB	
		R _L =2kΩ, V _O =0.15 to 1.65V, V _O =3.15 to 1.65V, Full Temperature Range	97				
		R _L =10kΩ, V _O =0.1 to 1.65V, V _O =3.2 to 1.65V, T _A =25°C	100	115			
		R _L =10kΩ, V _O =0.1 to 1.65V, V _O =3.2 to 1.65V, Full Temperature Range	97				
R _{OUT}	Closed-Loop Impedance	f=6MHz		6		Ω	
R _{IN}	Input Resistance			10		GΩ	
C _{IN}	Input Capacitance	Common Mode		11		pF	
		Differential Mode		6			
Φ _M	Phase Margin			86		°	
SR	Slew Rate	A _v =+1, V _O =1V _{pp} 10%-90%		6.1		V/μs	
THD+N	Total Harmonic Distortion + Noise	f=1kHz, A _v =1, BW=>500kHz		0.006		%	

Notes:

- 100% tested at T_A=25°C.
- Guaranteed by characterization.
- EMI rejection ratio is defined as EMIRR – 20log (V_{RFpeak} / ΔV_{OS}).

Electrical Specifications at +5V

+V_S=+5V, -V_S = 0V, V_{CM} = +V_S/2, and R_L = 10KΩ to +V_S/2, unless otherwise noted.

Symbol	Parameter	Condition	Min.	Typ.	Max.	Unit
I _S	Supply Current ⁽⁵⁾	T _A =25°C		0.9	1.1	mA
		Full Temperature Range			1.2	
I _{SC}	Short-Circuit Output Current ⁽⁵⁾	Sourcing V _O =V _{CM} , V _{IN} =100mV, T _A =25°C	60	90		mA
		Sourcing V _O =V _{CM} , V _{IN} =100mV, Full Temperature Range	48			
		Sinking V _O =V _{CM} , V _{IN} =-100mV, T _A =25°C	58	90		
		Sinking V _O =V _{CM} , V _{IN} =-100mV, Full Temperature Range	44			
EMIRR	EMI Rejection Ratio, +IN and -IN ⁽⁷⁾	V _{RFpeak} =100mVp, (-20dBVp) f=400MHz		75		dB
		V _{RFpeak} =100mVp, (-20dBVp) f=900MHz		78		
		V _{RFpeak} =100mVp, (-20dBVp) f=1800MHz		87		
PSRR	Power Supply Rejection Ratio ⁽⁵⁾	2.7V≤V+≤5.5V, V _O =1V, T _A =25°C	75	105		dB
		2.7V≤V+≤5.5V, V _O =1V, Full Temperature Range	74			
CMRR	Common Mode Rejection Ratio ⁽⁵⁾	-0.2V≤V _{CM} ≤V+ -1.2V	77	122		dB
CMIR	Input Common Mode Voltage Range ⁽⁵⁾	CMRR≥77dB	-0.2		3.8	V
V _{OS}	Input Offset Voltage ⁽⁵⁾	T _A =25°C		±0.3	±1.0	mV
		Full Temperature Range			±1.2	
dV _{IO}	Average Drift ⁽⁶⁾			±0.4	±2.0	μV/°C
I _{OS}	Input Offset Current			1		pA
I _{bn_Char}	Input Bias Current ⁽⁶⁾	T _A =				pA
		T _A =25°C		0.1	10.0	
e _n	Input-Referred Voltage Noise	Full Temperature Range			500	pA
		f=1kHz		11		
i _n	Input-Referred Current Noise	f=10kHz		10		nV/√Hz
		f=1kHz		0.005		pA/√Hz

Continued on the following page...

Electrical Specifications at +5V

+V_S=+5V, -V_S = 0V, V_{CM} = +V_S/2, and R_L = 10kΩ to +V_S/2, unless otherwise noted.

Symbol	Parameter	Condition	Min.	Typ.	Max.	Unit	
V _O	Output Voltage Swing High ⁽⁵⁾	R _L =2kΩ to V+/2, T _A =25°C		25	39	mV	
		R _L =2kΩ to V+/2, Full Temperature Range			47		
		R _L =10kΩ to V+/2, T _A =25°C		4	11		
		R _L =10kΩ to V+/2, Full Temperature Range			13		
	Output Voltage Swing Low ⁽⁵⁾	R _L =2kΩ to V+/2, T _A =25°C			24	38	mV
		R _L =2kΩ to V+/2, Full Temperature Range				50	
		R _L =10kΩ to V+/2, T _A =25°C			3	15	
		R _L =10kΩ to V+/2, Full Temperature Range				1	
GBW	Gain Bandwidth Product			9		MHz	
A _{VOL}	Large Signal Voltage Gain ⁽⁶⁾	R _L =2kΩ, V _O =0.15 to 2.5V, V _O =4.85 to 2.5V, T _A =25°C	105	118		dB	
		R _L =2kΩ, V _O =0.15 to 2.5V, V _O =4.85 to 2.5V, Full Temperature Range	102				
		R _L =10kΩ, V _O =0.1 to 2.5V, V _O =4.9 to 2.5V, T _A =25°C	105	120			
		R _L =10kΩ, V _O =0.1 to 2.5V, V _O =4.9 to 2.5V, Full Temperature Range	102				
R _{OUT}	Closed-Loop Impedance	f=6MHz		6		Ω	
R _{IN}	Input Resistance			10		GΩ	
C _{IN}	Input Capacitance	Common Mode		11		pF	
		Differential Mode		6			
Φ _M	Phase Margin			94		°	
SR	Slew Rate	A _v =+1, V _O =1V _{pp} 10%-90%		6.2		V/μs	
THD+N	Total Harmonic Distortion + Noise	f=1kHz, A _v =1, BW=>500kHz		0.006		%	

Notes:

- 100% tested at T_A=25°C.
- Guaranteed by characterization.
- EMI rejection ratio is defined as EMIRR – 20log (V_{RFpeak} / ΔV_{OS}).

Typical Performance Characteristics

+V_S=+3.3V, -V_S= 0V, V_{CM} = +V_S/2, and R_L = 10KΩ to +V_S/2, unless otherwise noted.

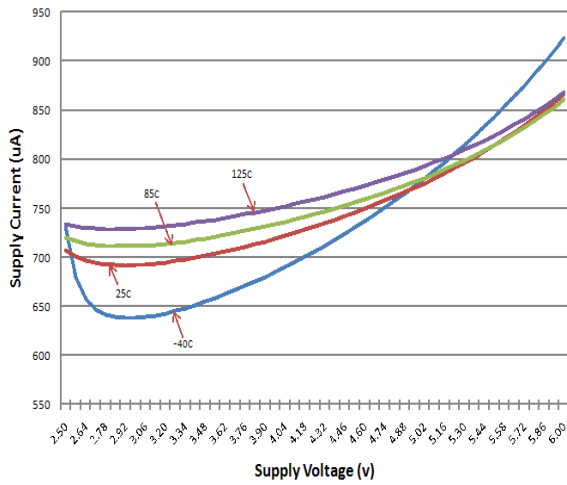

Figure 2. Supply Current vs. Supply Voltage

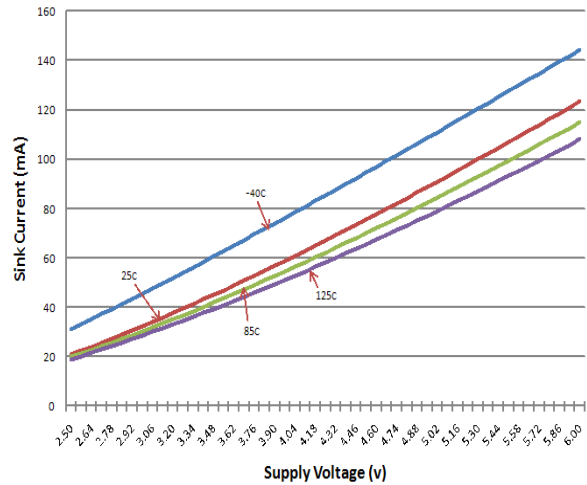

Figure 3. Sink Current vs. Supply Voltage

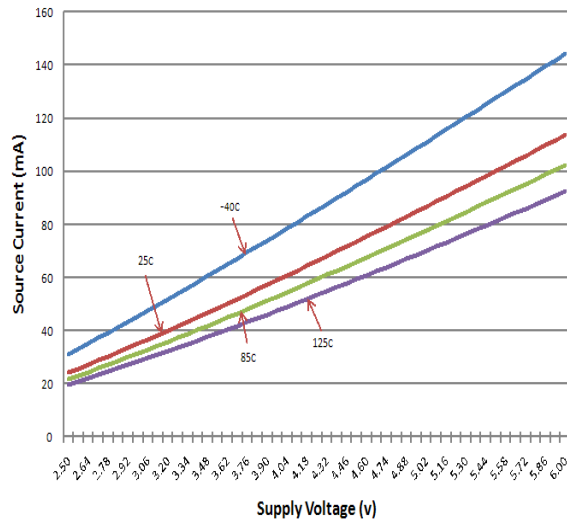

Figure 4. Source Current vs. Supply Voltage

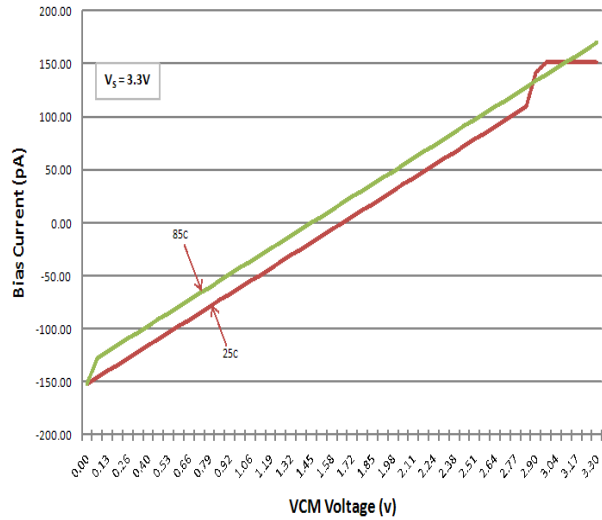

Figure 5. Input Bias Current vs. V_{CM} (3.3V)

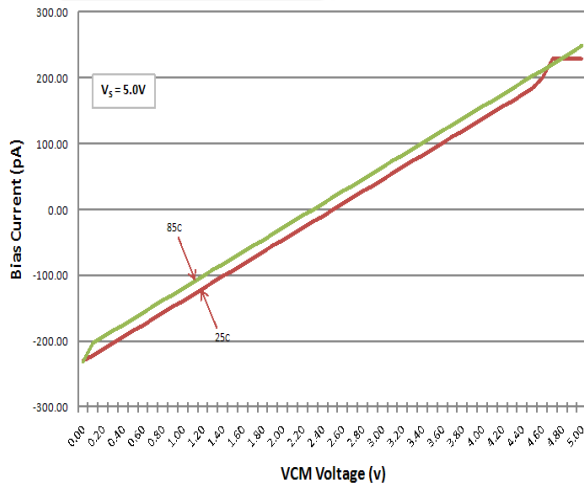

Figure 6. Input Bias Current vs. V_{CM} (5.0V)

Typical Performance Characteristics

$+V_S = +3.3V$, $-V_S = 0V$, $V_{CM} = +V_S/2$, and $R_L = 10K\Omega$ to $+V_S/2$, unless otherwise noted.

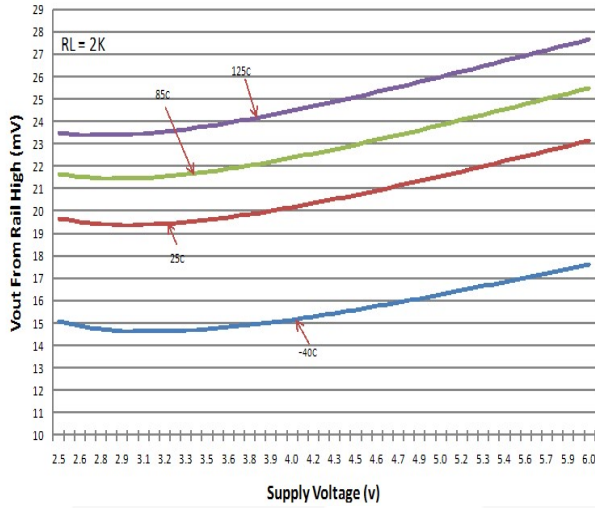

Figure 7. Output Swing High vs. Supply Voltage

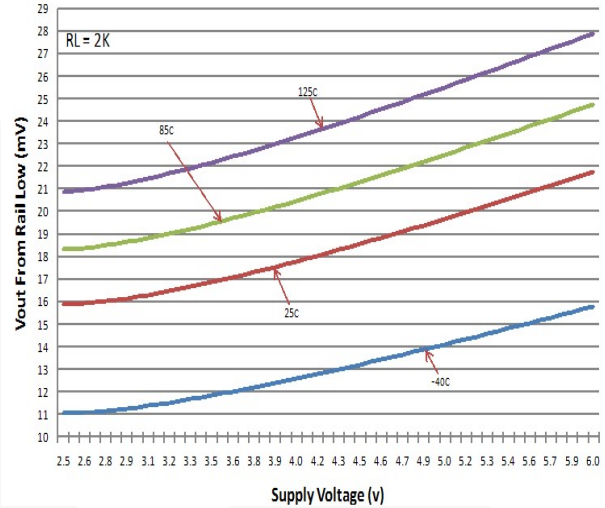

Figure 8. Output Swing Low vs. Supply Voltage

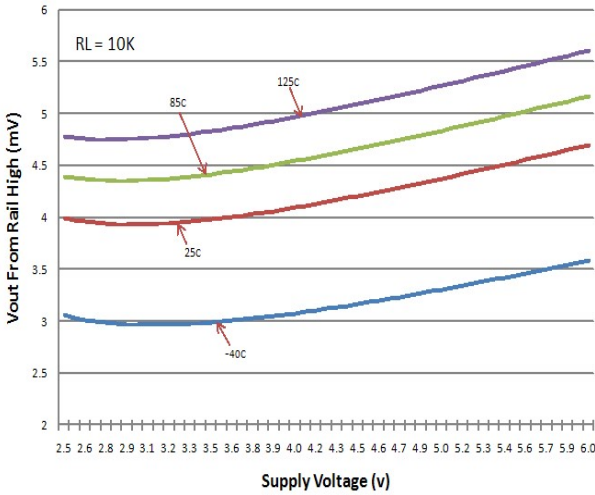

Figure 9. Output Swing High vs. Supply Voltage

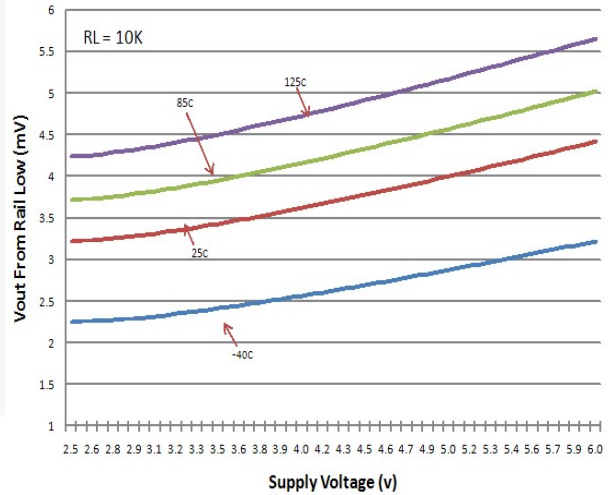

Figure 10. Output Swing Low vs. Supply Voltage

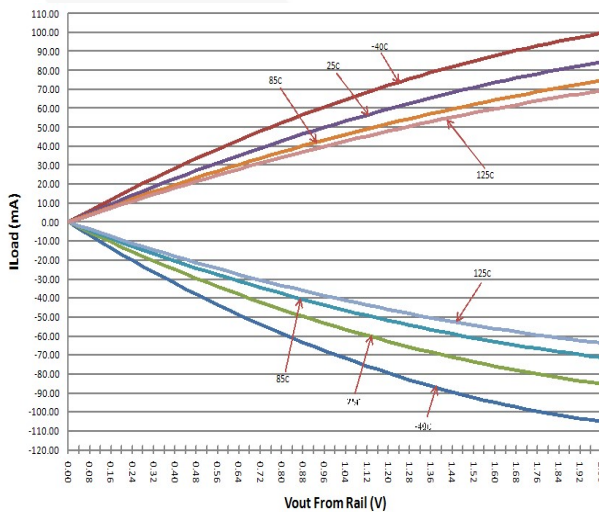

Figure 11. Output Voltage Swing vs. Load Current at 5.0V

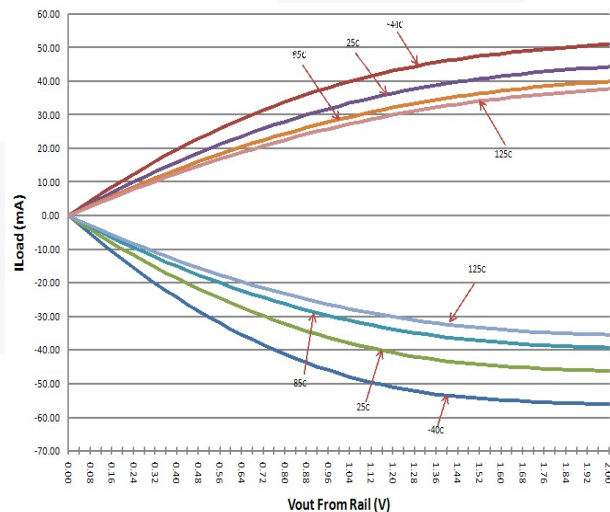

Figure 12. Output Voltage Swing vs. Load Current at 3.3V

Typical Performance Characteristics

+V_S=+3.3V, -V_S= 0V, V_{CM} = +V_S/2, and R_L = 10KΩ to +V_S/2, unless otherwise noted.

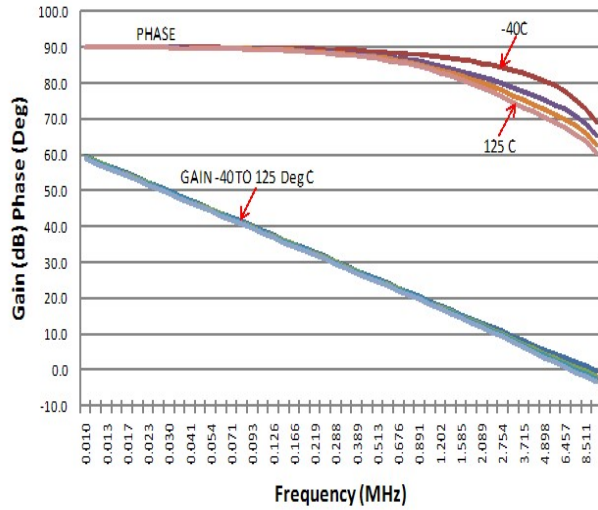

Figure 13. Open-Loop Gain/Phase vs. Temperature

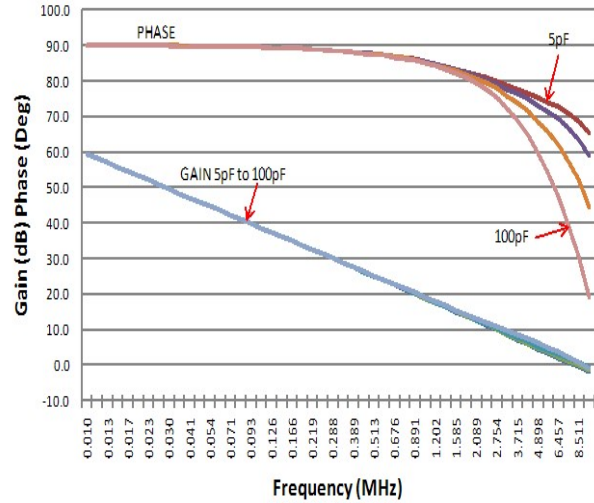

Figure 14. Open-Loop Gain/Phase vs. Load

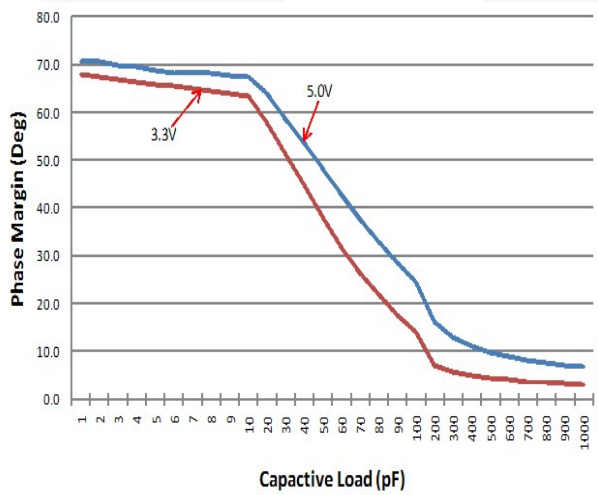

Figure 15. Phase Margin vs. Capacitive Load

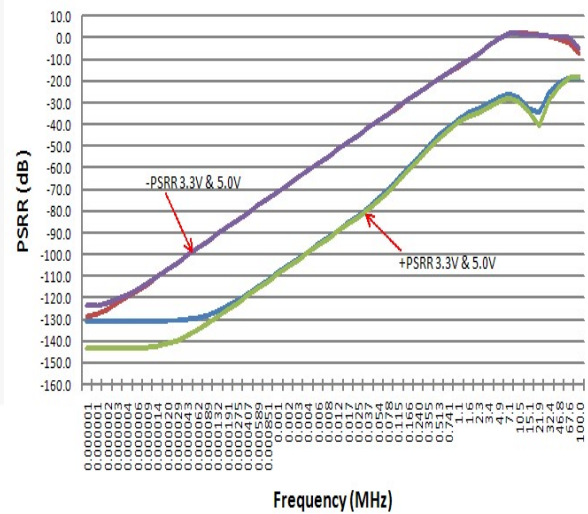

Figure 16. PSRR vs. Frequency

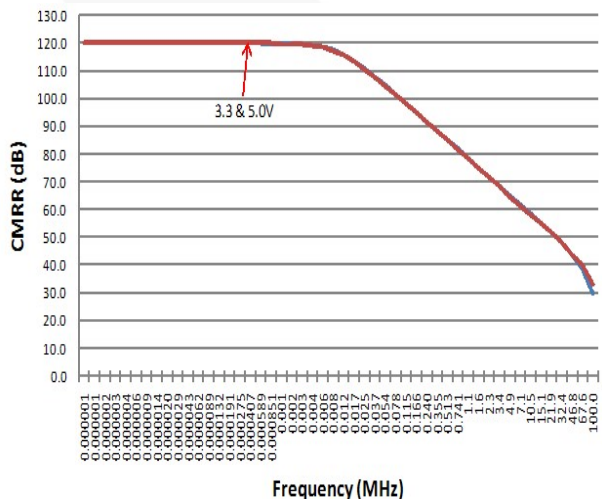

Figure 17. CMRR vs. Frequency

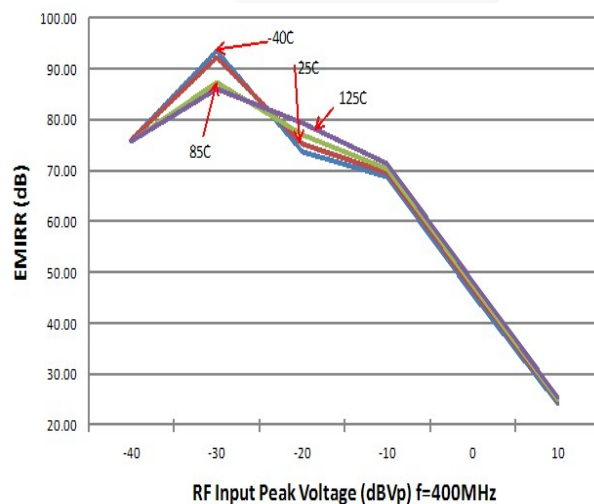

Figure 18. EMIRR vs. Power at 400MHz

Typical Performance Characteristics

$+V_S = +3.3V$, $-V_S = 0V$, $V_{CM} = +V_S/2$, and $R_L = 10K\Omega$ to $+V_S/2$, unless otherwise noted.

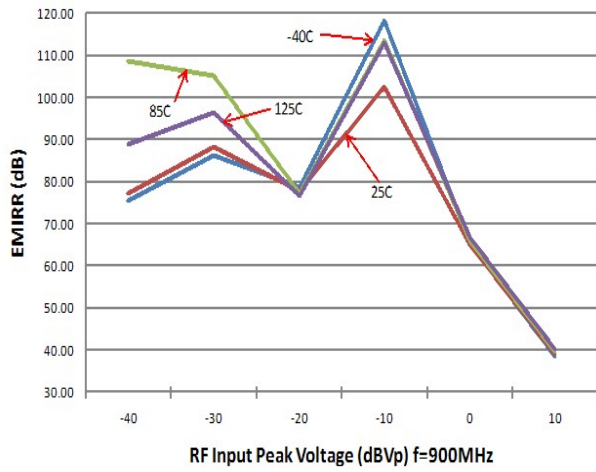

Figure 19. EMIRR vs. Power at 900MHz

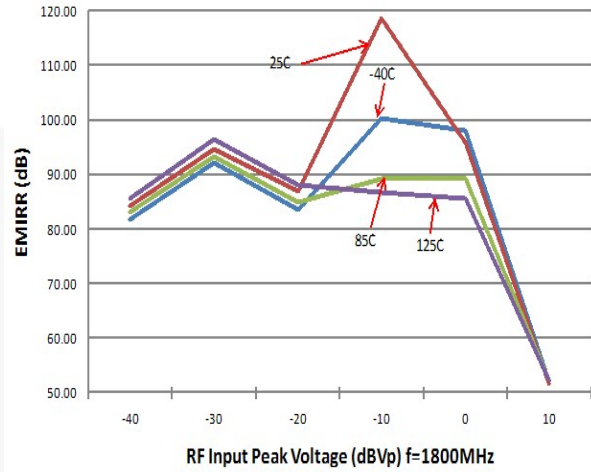

Figure 20. EMIRR vs. Power at 1800MHz

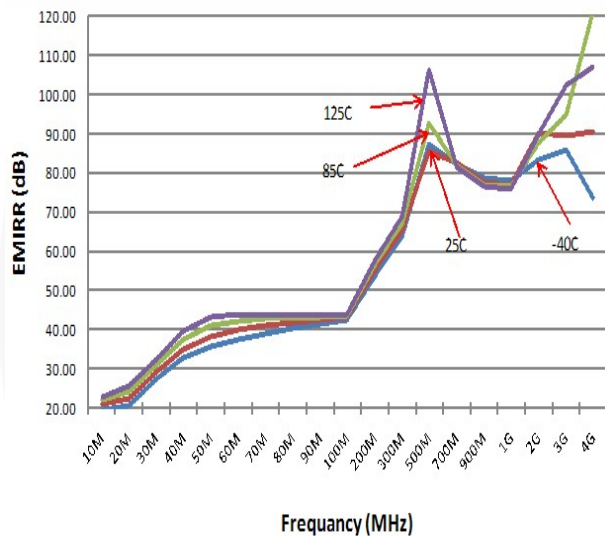

Figure 21. EMIRR vs. Frequency at 5.0V

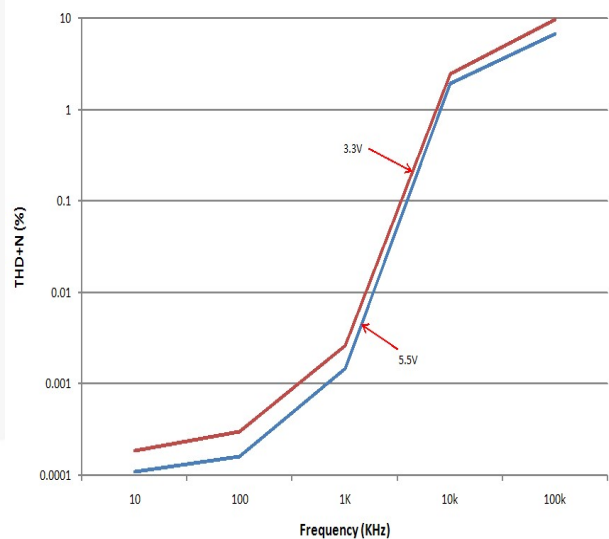

Figure 22. THD+N vs. Frequency

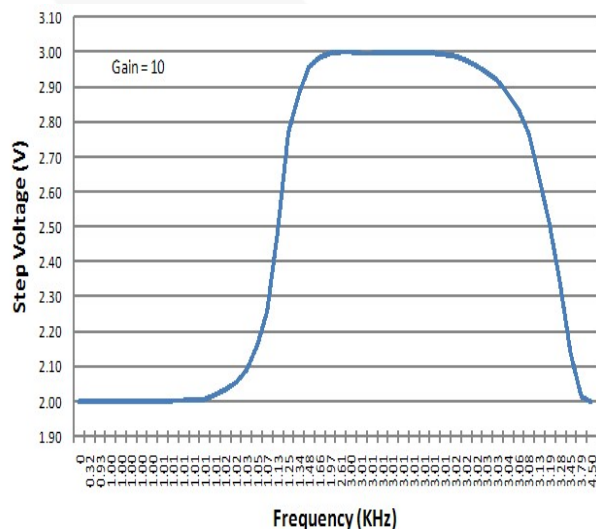

Figure 23. Large Signal Step Response

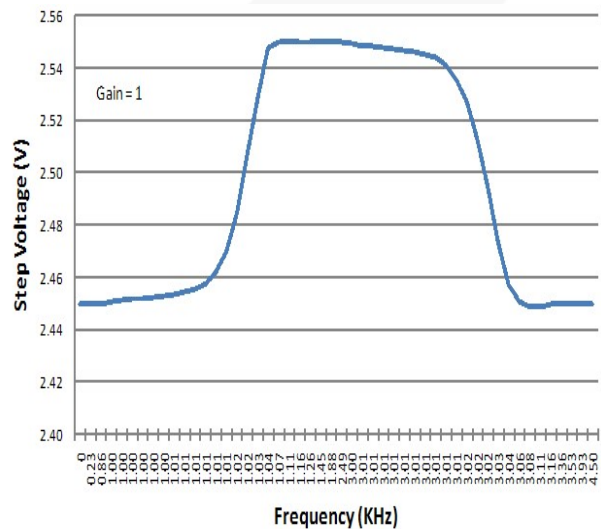

Figure 24. Small Signal Step Response

Typical Performance Characteristics

+V_S=+3.3V, -V_S = 0V, V_{CM} = +V_S/2, and R_L = 10KΩ to +V_S/2, unless otherwise noted.

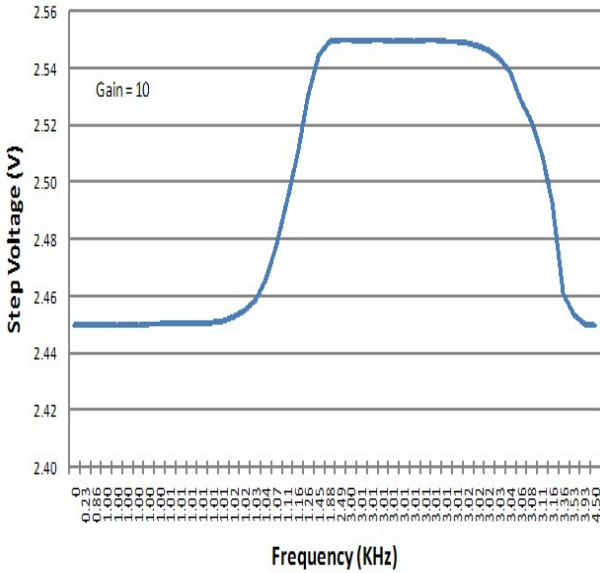

Figure 25. Small Signal Step Response

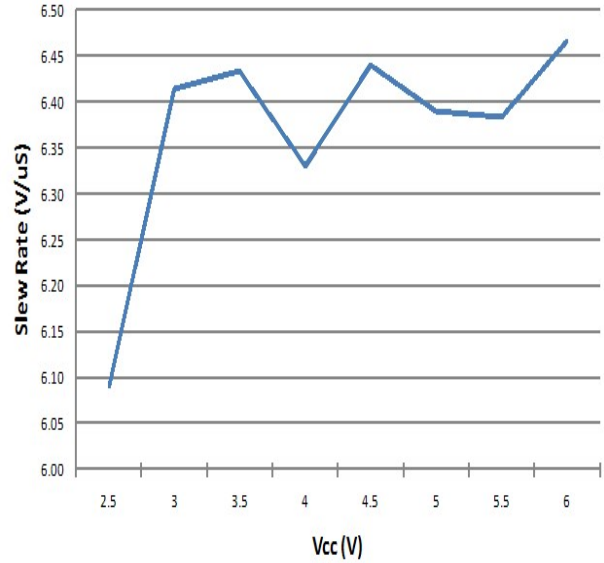

Figure 26. Slew Rate vs. Supply Voltage

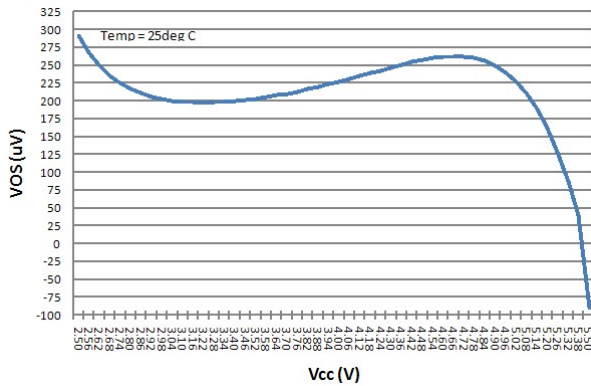

Figure 27. Vos vs. Supply Voltage

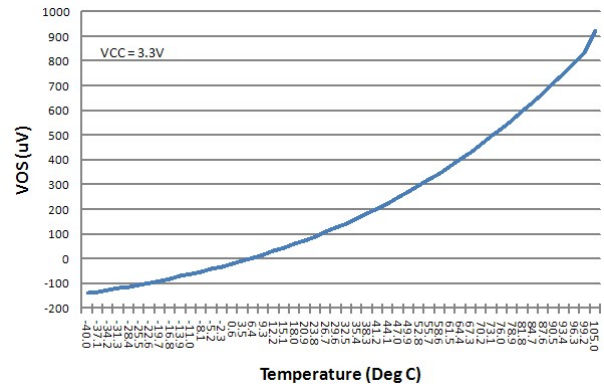

Figure 28. Vos vs. Temperature

Application Information

General Description

The FAN4852 amplifier includes single-supply, general-purpose amplifiers, fabricated on a CMOS process. The input and output are rail-to-rail and the part is unity gain stable. The typical non-inverting circuit schematic is shown in Figure 29.

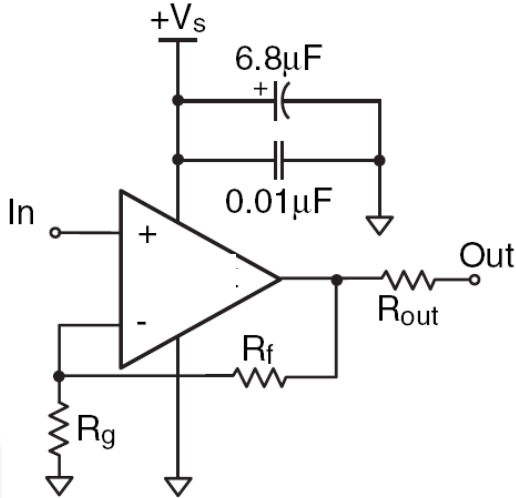

Figure 29. Typical Non-Inverting Configuration

Input Common Mode Voltage

The common mode input range includes ground. CMRR does not degrade when input levels are kept 1.2V below the rail. For the best CMRR when using a V_s of 5V, the maximum input voltage should be 3.8V.

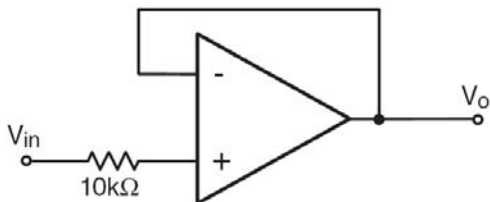

Figure 30. Circuit for Input Current Protection

Power Dissipation

The maximum internal power dissipation allowed is directly related to the maximum junction temperature. If the maximum junction temperature exceeds 150°C, performance degradation occurs. If the maximum junction temperature exceeds 150°C for an extended time, device failure may occur.

Overdrive Recovery

Overdrive of an amplifier occurs when the output and/or input ranges are exceeded. The recovery time varies based on whether the input or output is overdriven and by how much the range is exceeded. The FAN4852 typically recovers in less than 500ns from an overdrive condition. Figure 31 shows the FAN4852 amplifier in an overdriven condition.

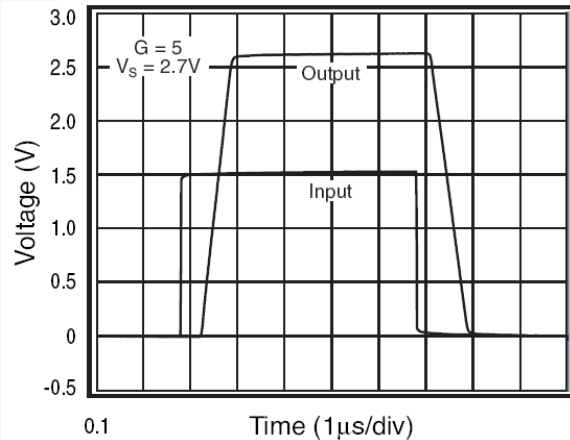

Figure 31. Overdrive Recovery

Driving Capacitive Loads

Figure 31 illustrates the response of the amplifier. A small series resistance (R_s) at the output, illustrated in Figure 32, improves stability and settling performance. R_s values provided achieve maximum bandwidth with less than 2dB of peaking. For maximum flatness, use a larger R_s . Capacitive loads larger than 500pF require the use of R_s .

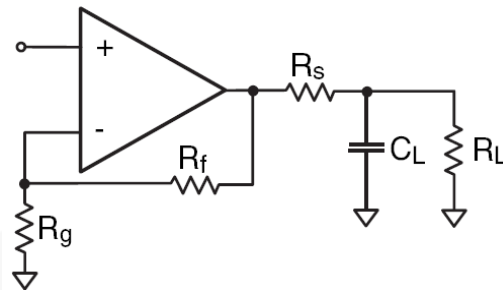

Figure 32. Typical Topology for Driving a Capacitive Load

Driving a capacitive load introduces phase-lag into the output signal, which reduces phase margin in the amplifier. The unity gain follower is the most sensitive configuration. In a unity gain follower configuration, the amplifier requires a 300Ω series resistor to drive a 100pF load.

Layout Considerations

General layout and supply bypassing play major roles in high-frequency performance. Fairchild evaluation boards help guide high-frequency layout and aid in device testing and characterization. Follow the steps below as a basis for high-frequency layout:

1. Include 6.8 μ F and 0.01 μ F ceramic capacitors.
2. Place the 6.8 μ F capacitor within 0.75 inches of the power pin.
3. Place the 0.01 μ F capacitor within 0.1 inches of the power pin.
4. Remove the ground plane under and around the part, especially near the input and output pins, to reduce parasitic capacitance.

Minimize all trace lengths to reduce series inductances.

Refer to the evaluation board layouts shown in Figure 33 for more information.

When evaluating only one channel, complete the following on the unused channel:

1. Ground the non-inverting input.
2. Short the output to the inverting input.

Evaluation Board	Description
FAN4852-010	Single Channel, Dual Supply

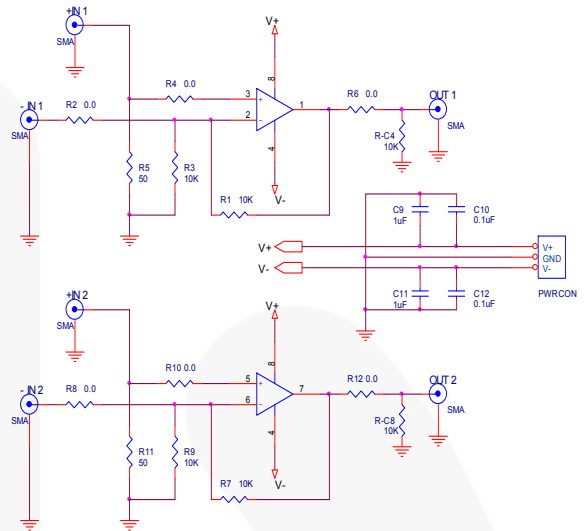

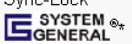

Figure 33. Evaluation Board Schematic



TRADEMARKS

The following includes registered and unregistered trademarks and service marks, owned by Fairchild Semiconductor and/or its global subsidiaries, and is not intended to be an exhaustive list of all such trademarks.

- | | | | |
|--------------------------|------------------------|---|---|
| 2Cool™ | FlashWriter®* | PDP SPM™ | The Power Franchise® |
| AccuPower™ | FPS™ | Power-SPM™ | The Right Technology for Your Success™ |
| Auto-SPM™ | F-PFS™ | PowerTrench® | the power franchise |
| AX-CAPT™ | FRFET® | PowerXS™ | TinyBoost™ |
| BitSiC® | Global Power Resource™ | Programmable Active Droop™ | TinyBuck™ |
| Build it Now™ | Green FPST™ | QFET® | TinyCalc™ |
| CorePLUS™ | Green FPST™ e-Series™ | QS™ | TinyLogic® |
| CorePOWER™ | Gmax™ | Quiet Series™ | TINYOPTO™ |
| CROSSVOLT™ | GT0™ | RapidConfigure™ | TinyPower™ |
| CTL™ | IntelliMAX™ |  | TinyPVM™ |
| Current Transfer Logic™ | ISOPLANAR™ | Saving our world, 1mWV/kW at a time™ | TinyWire™ |
| DEUXPEED® | MegaBuck™ | SignalWise™ | TranSiC® |
| Dual Cool™ | MICROCOUPLER™ | SmartMax™ | TriFault Detect™ |
| EcoSPARK® | MicroFET™ | SMART START™ | TRUECURRENT®* |
| EfficientMax™ | MicroPak™ | SPM® | µSerDes™ |
| ESBC™ | MicroPak2™ | STEALTH™ |  |
| F ™ | MillerDrive™ | SuperFET® | UHC® |
| Fairchild® | MotionMax™ | SuperSOT™-3 | Ultra FRFET™ |
| Fairchild Semiconductor® | Motion-SPM™ | SuperSOT™-6 | UniFET™ |
| FACT Quiet Series™ | mW Saver™ | SuperSOT™-8 | VCX™ |
| FACT® | OptoHIT™ | SupreMOS® | VisualMax™ |
| FAST® | OPTOLOGIC® | SyncFET™ | X5™ |
| FastvCore™ | OPTOPLANAR® | SyncLock™ | |
| FETBench™ | |  | |

* Trademarks of System General Corporation, used under license by Fairchild Semiconductor.

DISCLAIMER

FAIRCHILD SEMICONDUCTOR RESERVES THE RIGHT TO MAKE CHANGES WITHOUT FURTHER NOTICE TO ANY PRODUCTS HEREIN TO IMPROVE RELIABILITY, FUNCTION, OR DESIGN. FAIRCHILD DOES NOT ASSUME ANY LIABILITY ARISING OUT OF THE APPLICATION OR USE OF ANY PRODUCT OR CIRCUIT DESCRIBED HEREIN; NEITHER DOES IT CONVEY ANY LICENSE UNDER ITS PATENT RIGHTS, NOR THE RIGHTS OF OTHERS. THESE SPECIFICATIONS DO NOT EXPAND THE TERMS OF FAIRCHILD'S WORLDWIDE TERMS AND CONDITIONS, SPECIFICALLY THE WARRANTY THEREIN, WHICH COVERS THESE PRODUCTS.

LIFE SUPPORT POLICY

FAIRCHILD'S PRODUCTS ARE NOT AUTHORIZED FOR USE AS CRITICAL COMPONENTS IN LIFE SUPPORT DEVICES OR SYSTEMS WITHOUT THE EXPRESS WRITTEN APPROVAL OF FAIRCHILD SEMICONDUCTOR CORPORATION.

As used herein:

1. Life support devices or systems are devices or systems which, (a) are intended for surgical implant into the body or (b) support or sustain life, and (c) whose failure to perform when properly used in accordance with instructions for use provided in the labeling, can be reasonably expected to result in a significant injury of the user.
2. A critical component in any component of a life support, device, or system whose failure to perform can be reasonably expected to cause the failure of the life support device or system, or to affect its safety or effectiveness.

ANTI-COUNTERFEITING POLICY

Fairchild Semiconductor Corporation's Anti-Counterfeiting Policy. Fairchild's Anti-Counterfeiting Policy is also stated on our external website, www.fairchildsemi.com, under Sales Support.

Counterfeiting of semiconductor parts is a growing problem in the industry. All manufacturers of semiconductor products are experiencing counterfeiting of their parts. Customers who inadvertently purchase counterfeit parts experience many problems such as loss of brand reputation, substandard performance, failed applications, and increased cost of production and manufacturing delays. Fairchild is taking strong measures to protect ourselves and our customers from the proliferation of counterfeit parts. Fairchild strongly encourages customers to purchase Fairchild parts either directly from Fairchild or from Authorized Fairchild Distributors who are listed by country on our web page cited above. Products customers buy either from Fairchild directly or from Authorized Fairchild Distributors are genuine parts, have full traceability, meet Fairchild's quality standards for handling and storage and provide access to Fairchild's full range of up-to-date technical and product information. Fairchild and our Authorized Distributors will stand behind all warranties and will appropriately address any warranty issues that may arise. Fairchild will not provide any warranty coverage or other assistance for parts bought from Unauthorized Sources. Fairchild is committed to combat this global problem and encourage our customers to do their part in stopping this practice by buying direct or from authorized distributors.

PRODUCT STATUS DEFINITIONS

Definition of Terms

Datasheet Identification	Product Status	Definition
Advance Information	Formative / In Design	Datasheet contains the design specifications for product development. Specifications may change in any manner without notice.
Preliminary	First Production	Datasheet contains preliminary data; supplementary data will be published at a later date. Fairchild Semiconductor reserves the right to make changes at any time without notice to improve design.
No Identification Needed	Full Production	Datasheet contains final specifications. Fairchild Semiconductor reserves the right to make changes at any time without notice to improve the design.
Obsolete	Not In Production	Datasheet contains specifications on a product that is discontinued by Fairchild Semiconductor. The datasheet is for reference information only.

Rev. 155