

# TMX W235

SAW Bandpass Filter - MEDICAL TELEMETRY  
*Preliminary Specification (Rev-)*

■ Technical overview .....	P01
■ Matching Network Configuration .....	P01
■ Typical Response (Measurement) .....	P02
■ Package Drawing .....	P03

# TMX W235

## SAW Bandpass Filter - MEDICAL TELEMETRY Preliminary Specification (Rev-)

May 30<sup>th</sup>, 2005

Operating temperature range : [0°C; +50°C]

Electrical Parameters	Unit	Minimum	Typical <sup>(1)</sup>	Maximum
Source Impedance (single ended)	Ω	-	50 <sup>(2)</sup>	-
Load Impedance (single ended)	Ω	-	50 <sup>(2)</sup>	-
Center Frequency fo	MHz	-	611	-
- 2 dB Bandwidth	MHz	6	-	-
<b>Absolute Attenuation</b>				
0 kHz to 550 MHz	dB	42	48	-
550 MHz to 598 MHz	dB	42	46	-
598 MHz to 601.5 MHz	dB	45	54	-
621 MHz to 900 MHz	dB	45	57	-
900 MHz to 1300 MHz	dB	40	48	-
1300 MHz to 1800 MHz	dB	30	46	-
1800 MHz to 2000 MHz	dB	20	29	-
2000 MHz to 3000 MHz	dB	15	20	-
Insertion Loss @ f0	dB	-	1.9	3.0
Amplitude Variation in 608 MHz-614 MHz <sup>(3)</sup>	dB	-	1.0	1.6
Group Delay Variation in 608 MHz-614 MHz	ns	-	50	100
Input / Output VSWR in 608 MHz-614 MHz at 25°C	-	-	1.6:1	2.1 :1
Input / Output VSWR in 608 MHz-614 MHz	-	-	1.6:1	2.5 :1
Temperature coefficient	ppm/°C	-	-32	-
Maximum input power in 608 MHz-614 MHz <sup>(4)</sup>	dBm	-	-	30
<b>Package type &amp; size</b>				
Length x Width	mm <sup>2</sup>	-	5.0 x 5.0	-
Height	mm	-	1.6	1.8
<b>Pin Out</b>				
Input	2	Output	6	
Case Ground	1,3,4,5,7,8	To Be Grounded	1,3,4,5,7,8	

**Notes :**

- (1) Typical values are nominal performances at room temperature
- (2) No external matching is required
- (3) The amplitude variation is defined as the maximum level – minimum level over the given bandwidth
- (4) Minimum lifetime @ 50°C, 30dBm CW higher than 50000 hours.

### 50 Ω / 50 Ω CONFIGURATION

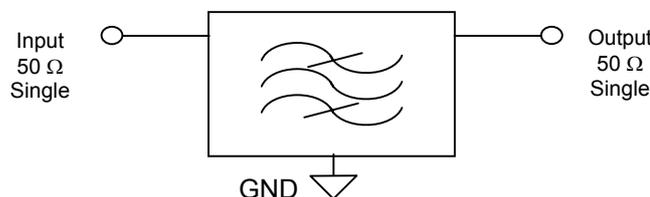

# TMX W235

## SAW Bandpass Filter - MEDICAL TELEMETRY Preliminary Specification (Rev-)

May 30<sup>th</sup>, 2005

### TYPICAL S21 RESPONSE

The template indicated is linked to the specification over [0°C; +50°C] temperature range.

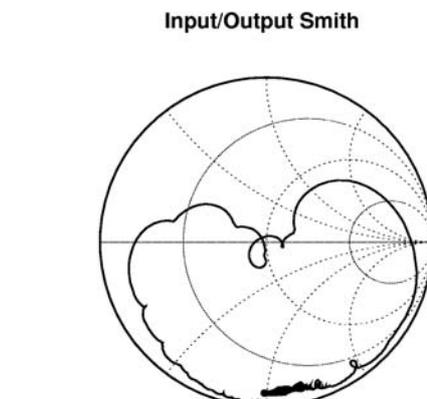
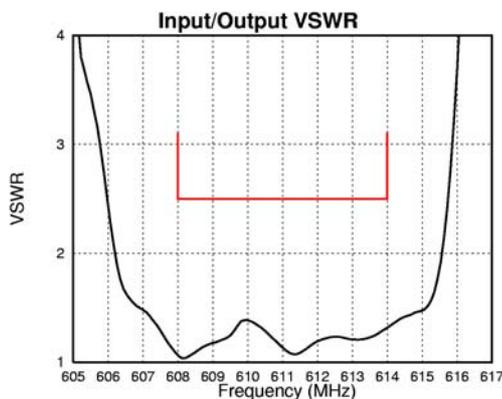
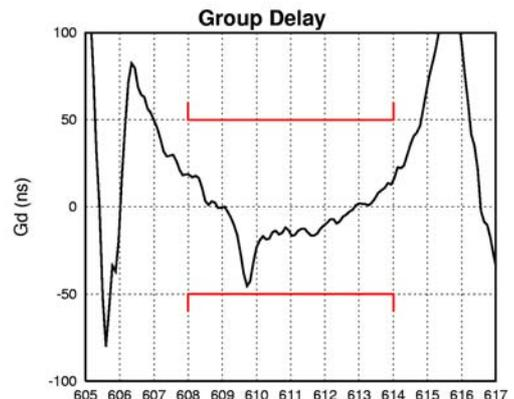
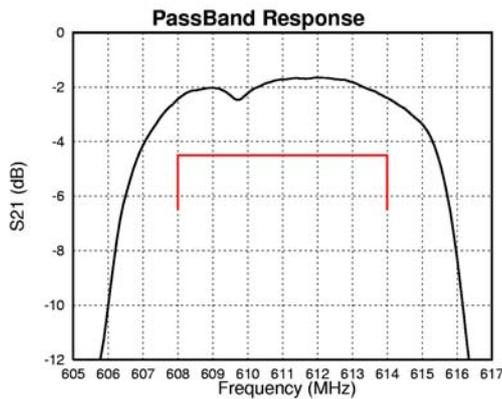
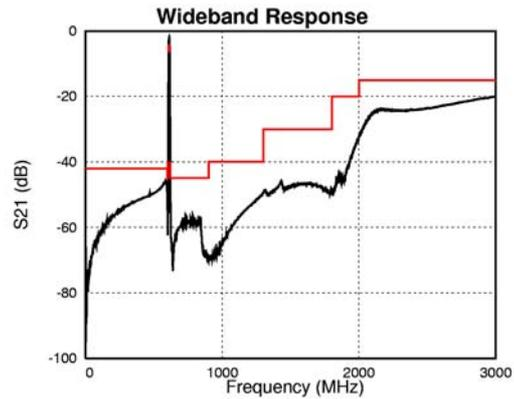
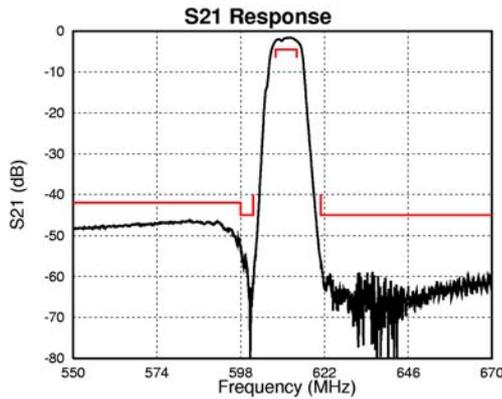

# TMX W235

## SAW Bandpass Filter - MEDICAL TELEMETRY Preliminary Specification (Rev-)

May 30<sup>th</sup>, 2005

### PACKAGE DRAWING

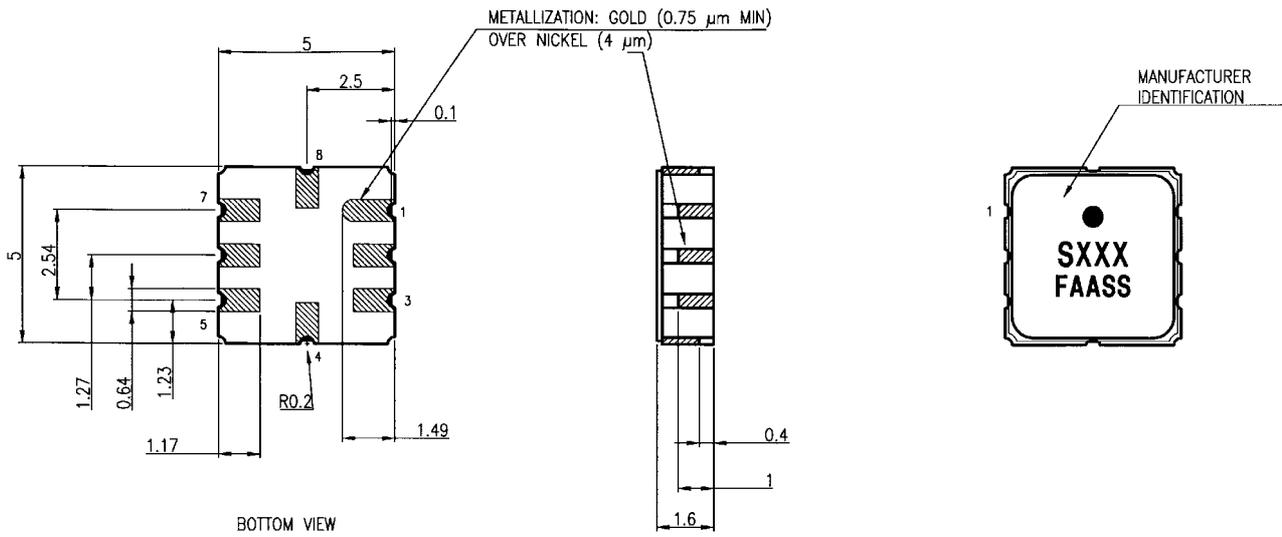

ALL DIMENSIONS IN mm

### LAND PATTERN

