

FEATURES

- Very Low Drift – 2ppm/°C Max TC
- Pin Compatible with LT1021-5, REF-02
- Output Sources 15mA, Sinks 10mA
- Excellent Transient Response Suitable for A-to-D Reference Inputs
- Noise Reduction Pin
- Excellent Long-Term Stability
- Less Than 1ppm p-p Noise (0.1Hz to 10Hz)

APPLICATIONS

- A-to-D and D-to-A Converters
- Digital Voltmeters
- Reference Standard
- Precision Current Source

DESCRIPTION

The LT1027 is a precision reference with extra-low drift, superior accuracy, excellent line and load regulation and low output impedance at high frequency. This device is intended for use in 12- to 16-bit A-to-D and D-to-A systems where demanding accuracy requirements must be met without the use of power-hungry heated-substrate references. The fast-settling output recovers quickly from load transients such as those presented by A-to-D converter reference inputs. The LT1027 brings together both outstanding accuracy and temperature coefficient specifications.

The LT1027 reference is based on LTC's proprietary advanced sub-surface zero-current process which eliminates noise and stability problems associated with surface-based devices.

TYPICAL APPLICATION

Supply Voltage = 5V to V_{CC} to the LTC1290 12

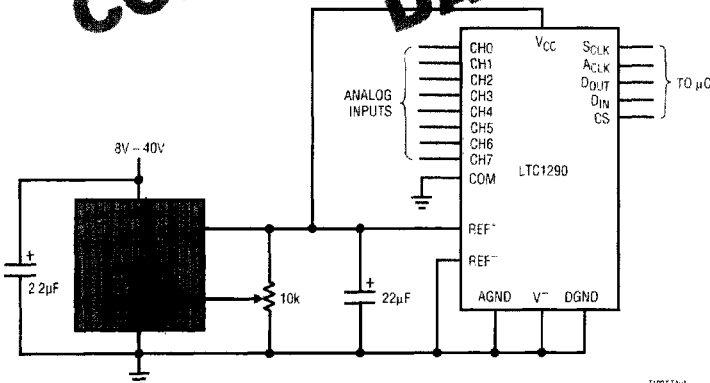
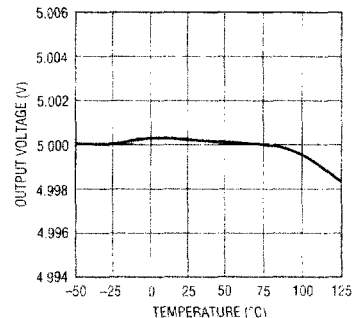
Output Voltage

LT1027 J14

ABSOLUTE MAXIMUM RATINGS

Supply Voltage (V_{IN})	40V
Input-Output Voltage Differential	35V
Output to Ground Voltage	7V
V_{TRIM} to Ground Voltage	
Positive	5V
Negative	-0.3V
Output Short Circuit Duration	
$V_{IN} > 20V$	10 sec.
$V_{IN} \leq 20V$	Indefinite
Operating Temperature Range	
LT1027M	-55°C to 125°C
LT1027C	0°C to 70°C
Storage Temperature Range	
All Devices	-65°C to 150°C
Lead Temperature (Soldering, 10 sec.)	300°C

PACKAGE/ORDER INFORMATION

<p>TOP VIEW H PACKAGE 8-LEAD TO-5 METAL CAN</p>	<p>ORDER PART NUMBER</p> <p>LT1027ACH LT1027BCH LT1027CCH LT1027DCH LT1027ECH LT1027DMH LT1027EMH</p>
<p>TOP VIEW N8 PACKAGE 8-LEAD PLASTIC DIP</p>	<p>LT1027BCN8 LT1027CCN8 LT1027DCN8 LT1027ECN8</p>
<p>TOP VIEW S8 PACKAGE 8-LEAD PLASTIC SOIC</p>	<p>LT1027ECS8</p>

* CONNECTED INTERNALLY. DO NOT CONNECT EXTERNAL CIRCUITRY TO THESE PINS

7

ELECTRICAL CHARACTERISTICS

$T_A = 25^\circ\text{C}$, $V_{IN} = 10V$, $I_{LOAD} = 0$, unless otherwise specified.

SYMBOL	PARAMETER	CONDITIONS	MIN	TYP	MAX	UNITS
V_{OUT}	Output Voltage (Note 1)	LT1027A	4.9990	5.000	5.0010	V
		LT1027B, C, D	4.9975	5.000	5.0025	V
		LT1027E	4.9950	5.000	5.0050	V
TCV_{OUT}	Output Voltage Temperature Coefficient (Note 2)	LT1027A, B	●	1	2	ppm/°C
		LT1027C	●	2	3	ppm/°C
		LT1027D	●	2	5	ppm/°C
		LT1027E	●	3	7.5	ppm/°C
	Line Regulation (Note 3)	$8V \leq V_{IN} \leq 10V$	●	6	12	ppm/V
		$10V \leq V_{IN} \leq 40V$	●	3	6	ppm/V
	Load Regulation (Note 3)	Sourcing Current	●	3	6	ppm/mA
		$0 \leq I_{OUT} \leq 15mA$	●		8	ppm/mA
		Sinking Current	●	30	50	ppm/mA
		$0 \geq I_{OUT} \geq -10mA$	●		100	ppm/mA

ELECTRICAL CHARACTERISTICS $T_A = 25^\circ\text{C}$, $V_{IN} = 10\text{V}$, $I_{LOAD} = 0$, unless otherwise specified.

SYMBOL	PARAMETER	CONDITIONS	MIN	TYP	MAX	UNITS
	Supply Current			1.8	2.4 2.8	mA mA
	V_{TRIM} Adjust Range		±30	±50		mV
e_n	Output Noise (Note 4)	$0.1\text{Hz} \leq f \leq 10\text{Hz}$		3		$\mu\text{Vp-p}$
		$10\text{Hz} \leq f \leq 1\text{kHz}$		2.0	4.0	μVRMS
	Temperature Hysteresis	H package; $\Delta T = 25^\circ\text{C}$		10		ppm
	Long Term Stability	H package		20		ppm/month

The ● denotes specifications which apply over the operating temperature range.

Note 1: Output voltage is measured immediately after turn-on. Changes due to chip warm-up are typically less than 0.005%.

Note 2: Temperature coefficient is determined by the "box" method in which the maximum ΔV_{OUT} over the temperature range is divided by ΔT .

Note 3: Line and load regulation measurements are done on a pulse basis. Output voltage changes due to die temperature change must be taken into account separately. Package thermal resistance is 150°C/W for TO-5 (H), 130°C/W for plastic DIP (N8), and 180°C/W for plastic SOIC (S8).

Note 4: RMS noise is measured with an 8-pole bandpass filter with a center frequency of 30Hz and a Q of 1.5. The filter output is then rectified and integrated for a fixed time period, resulting in an average, as opposed to RMS voltage. A correction factor is used to convert average to RMS. This value is then used to obtain RMS noise voltage in the 10Hz to 1000Hz frequency band. This test also screens for low-frequency "popcorn" noise within the bandwidth of the filter. Consult factory for 100% 0.1Hz to 10Hz noise testing.

TYPICAL PERFORMANCE CHARACTERISTICS

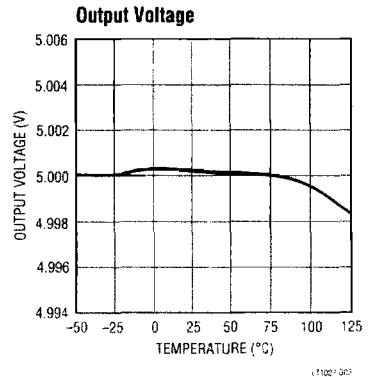
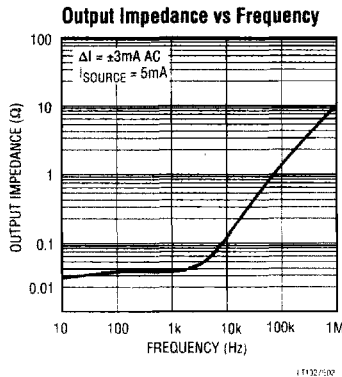
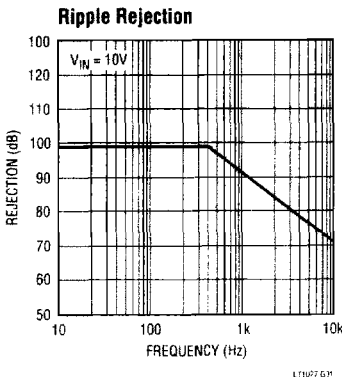

TYPICAL PERFORMANCE CHARACTERISTICS

Start-Up and Turn-Off (No Load)

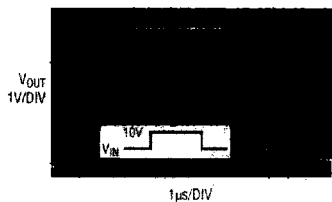

Start-Up and Turn-Off

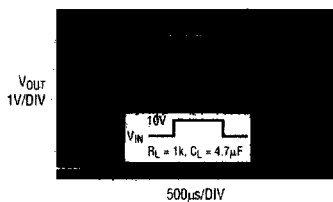

Quiescent Current

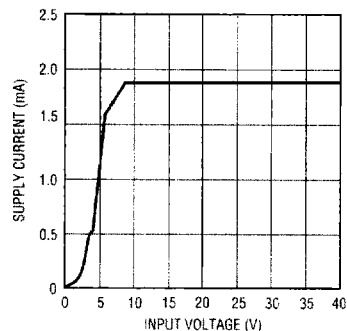

LT1027GK

Load Regulation

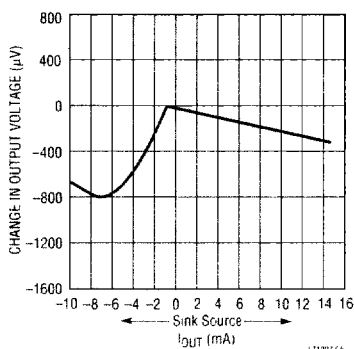

LT1027-56

Line Regulation

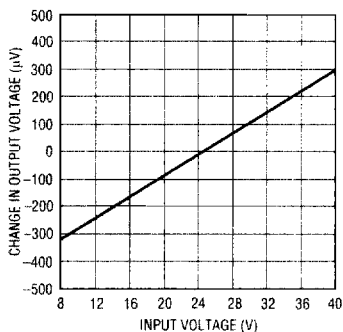

LT1027-56

Output Noise Voltage Density

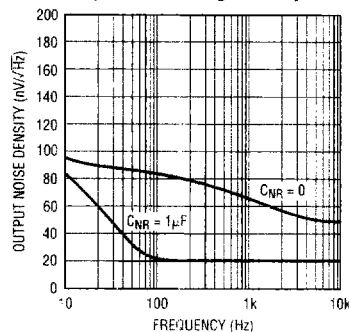

LT1027-56

Output Settling Time (Sourcing)

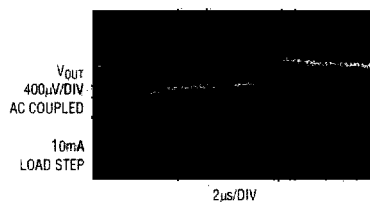

Output Settling Time (Sinking)

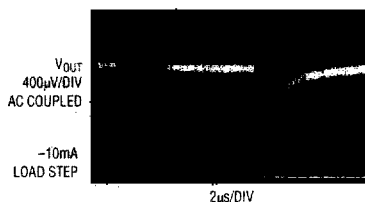

0.1Hz to 10Hz Output Noise Filtering = 1 zero at 0.1Hz
2 poles at 10Hz

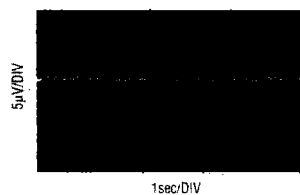

APPLICATIONS INFORMATION

Effect of Reference Drift on System Accuracy

A large portion of the temperature drift error budget in many systems is the system reference voltage. This graph indicates the maximum temperature coefficient allowable if the reference is to contribute no more than 1/2LSB error to the overall system performance. The example shown is a 12-bit system designed to operate over a temperature range from 25°C to 65°C. Assuming the system calibration is performed at 25°C, the temperature span is 40°C. It can be seen from the graph that the temperature coefficient of the reference must be no worse than 3ppm/°C if it is to contribute less than 1/2LSB error. For this reason, the LT1027 has been optimized for low drift.

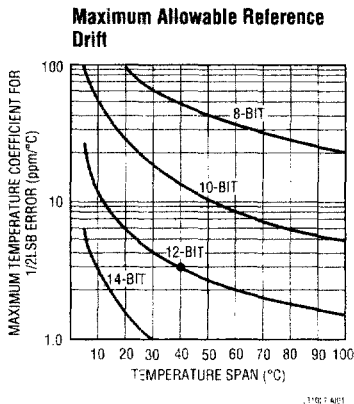

Trimming Output Voltage

The LT1027 has an adjustment pin for trimming output voltage. The impedance of the V_{ADJ} pin is about 20k Ω with an open circuit voltage of 2.5V. A ± 30 mV guaranteed trim range is achievable by tying the V_{ADJ} pin to the wiper of a 10k potentiometer connecting between the output and ground. Trimming output voltage does not affect the TC of the device.

Noise Reduction

The positive input of the internal scaling amplifier is brought out as the Noise Reduction (NR) pin. Connecting a 1 μ F Mylar capacitor between this pin and ground will reduce the wideband noise of the LT1027 from 2.0 μ V_{RMS}

to approximately 1.2 μ V_{RMS} in a 10Hz to 1kHz bandwidth. Transient response is not affected by this capacitor. Start-up settling time will increase to several milliseconds due to the 7k Ω impedance looking into the NR pin. The capacitor *must* be a low-leakage type. Electrolytics are *not* suitable for this application. Just 100nA leakage current will result in a 150ppm error in output voltage. This pin is the most sensitive pin on the device. For maximum protection a guard ring is recommended. The ring should be driven from a resistive divider from V_{OUT} set to 4.4V (the open circuit voltage on the NR pin).

Transient Response

The LT1027 has been optimized for transient response. Settling Time is under 2 μ s when an AC-coupled 10mA load transient is applied to the output. The LT1027 achieves fast settling by using a class B NPN/PNP output stage. When sinking current, the device may oscillate with capacitive loads greater than 100pF. The LT1027 is stable with all capacitive loads when at no DC load or when sourcing current, although for best settling time either no output bypass capacitor or a 4.7 μ F tantalum unit is recommended. An 0.1 μ F ceramic output capacitor will *maximize output ringing* and is *not* recommended.

Kelvin Connections

Although the LT1027 does not have true force-sense capability, proper hook-up can improve line loss and ground loop problems significantly. Since the ground pin of the LT1027 carries only 2mA, it can be used as a low-side sense line, greatly reducing ground loop problems on the low side of the reference. The V_{OUT} pin should be close to the load or connected via a heavy trace as the resistance of this trace directly affects load regulation. It is important to remember that a 1.22mV drop due to trace resistance is equivalent to a 1LSB error in a 5VFS, 12-bit system.

The circuits in Figures 1 and 2 illustrate proper hook-up to minimize errors due to ground loops and line losses. Losses in the output lead can be further reduced by adding a PNP boost transistor if load current is 5mA or higher. R2 can be added to further reduce current in the output sense load.

APPLICATIONS INFORMATION

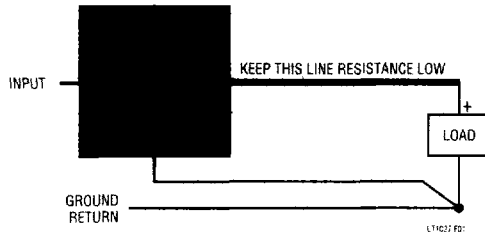
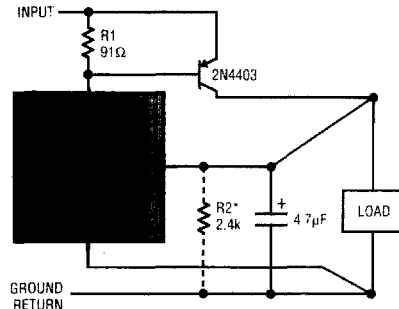

Figure 1. Standard Hook-Up



*OPTIONAL—REDUCES CURRENT IN OUTPUT SENSE LEAD

LT1027-2

Figure 2. Driving Higher Load Currents

APPLICATION CIRCUITS

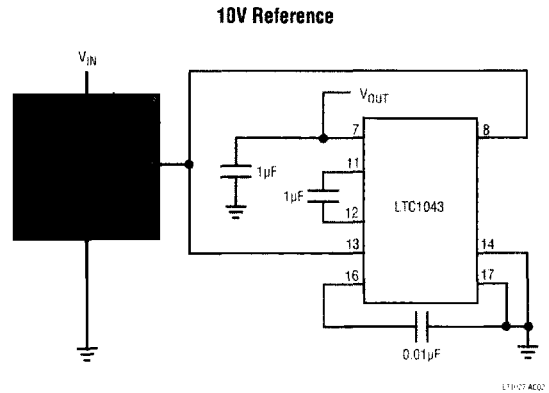
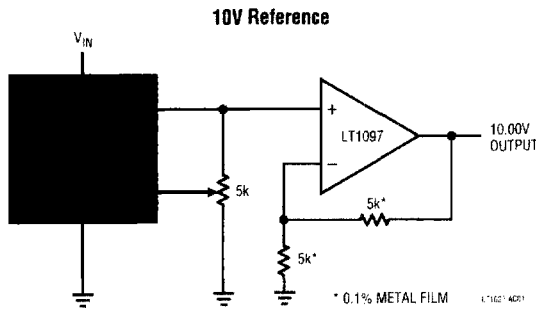

7

Operating 5V Reference from 5V Supply

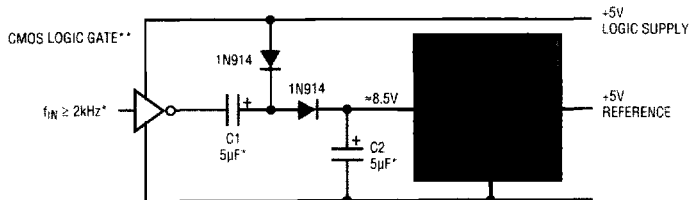

*FOR HIGHER FREQUENCIES C1 AND C2 MAY BE DECREASED.
 **PARALLEL GATES FOR HIGHER REFERENCE CURRENT LOADING.

LT1027-3

EQUIVALENT SCHEMATIC

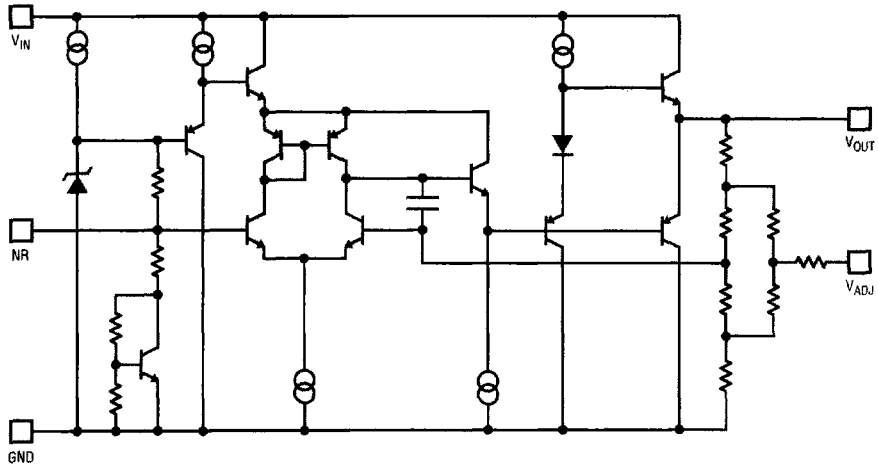

OUTPUT CURRENT LIMIT AND
BIAS CIRCUITS NOT SHOWN.

LT1027-25H