



IRF Series Data Sheet

The IRF Data Sheet describes 32 devices, 28 N-Channel and 4 P-Channel, all contained in the TO-204AA or TO-204AE package. This data sheet is arranged to show common tabular and graphical information between devices.

Absolute maximum ratings and parametric data are presented in tabular format with devices grouped according to generically shared parameters. For each parametric rating, devices are categorized by N and P channel and listed in alpha-numeric order. The conditions specified for a given parametric test are provided in the right hand column of each table.

Graphical information is grouped by devices in

alpha-numeric order. Where the information is device specific, we have assigned a numeric character for the graph and an alpha character to a given device. (See Table A below). Where graphs are polarity specific as in figures 10, 12, 14 and 15, we have indicated N-Channel or P-Channel. The Thermal Impedance Graph (Fig. 11) is the only exception where a graph is common to both N-Channel and P-Channel devices since the thermal impedance is only dependent on the die size and package.

In Table A below, a legend is provided cross referencing the part number to its assigned alpha code. A given device will retain this alpha code for each device specific graph.

Table A

DEVICE	ALPHA DESIGNATION	DEVICE	ALPHA DESIGNATION
IRF034	a	IRF460	q
IRF044	b	IRFAC30	r
IRF054	c	IRFAC40	s
IRF130	d	IRFAE30	t
IRF140	e	IRFAE40	u
IRF150	f	IRFAE50	v
IRF230	g	IRFAF30	w
IRF240	h	IRFAF40	x
IRF250	i	IRFAF50	y
IRF330	j	IRFAG30	z
IRF340	k	IRFAG40	aa
IRF350	l	IRFAG540	bb
IRF360	m	IRF9130	cc
IRF430	n	IRF9140	dd
IRF440	o	IRF9230	ee
IRF450	p	IRF9240	ff





HEXFET, Mil-Qualified

T03/HEXFET/N-Channel

Part Numbers			Hexfet Cross Reference	Voltage	Current T _c = 25°C (A)	MIL-S-19500	Qualification	Case Style	
JEDEC	JANTX	JANTXV							
2N6756	JANTX2N6756	JANTXV2N6756	IRF130	100V	14.0	/542	19500-488-81	TO-204AA TO-3 	
2N6758	JANTX2N6758	JANTXV2N6758	IRF230	200V	9.0	/542	19500-488-81		
2N6760	JANTX2N6760	JANTXV2N6760	IRF330	400V	5.5	/542	19500-488-81		
2N6762	JANTX2N6762	JANTXV2N6762	IRF430	500V	4.5	/542	19500-489-81		
2N6764	JANTX2N6764	JANTXV2N6764	IRF150	100V	38.0	/543	19500-490-81		
2N6766	JANTX2N6766	JANTXV2N6766	IRF250	200V	30.0	/543	19500-490-81		
2N6768	JANTX2N6768	JANTXV2N6768	IRF350	400V	14.0	/543	19500-960-82		
2N6770	JANTX2N6770	JANTXV2N6770	IRF450	500V	12.0	/543	19500-960-82		
T03/HEXFET/P-Channel									
2N6804	JANTX2N6804	JANTXV2N6804	IRF9130	-100V	-12.0	/562	19500-811-86		
2N6806	JANTX2N6806	JANTXV2N6806	IRF9230	-200V	-6.5	/562	19500-811-86		

FOR OTHER GOVERNMENT/SPACE QUALIFIED PRODUCTS REFER TO SECTION E.

RADIATION HARDENED

For Radiation Hardened HEXFETs contained in the TO-204AA/TO-204AE package outline, refer to the RAD HARD SECTION Pages H-1 to H-74.

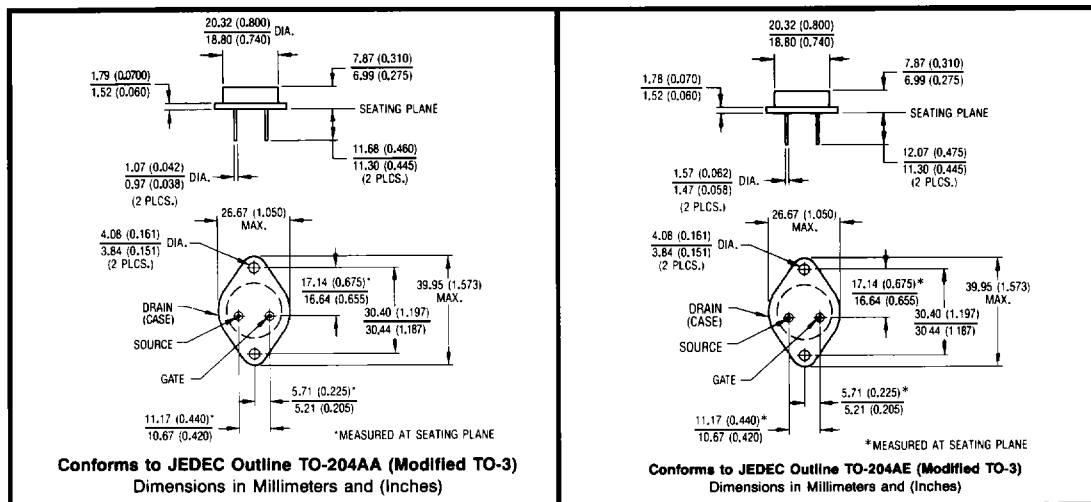

INTERNATIONAL RECTIFIER



REPETITIVE AVALANCHE AND dv/dt RATED

HEXFET® TRANSISTORS

IRF SERIES

IRF034 THRU IRFAG50
IRF9130 THRU IRF9240

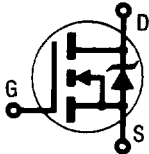

N-CHANNEL

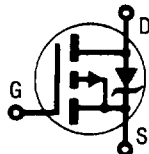

P-CHANNEL

Description

The HEXFET® technology is the key to International Rectifier's advanced line of power MOSFET transistors. The efficient geometry and unique processing of this latest "State of the Art" design achieves: very low on-state resistance combined with high transconductance; superior reverse energy and diode recovery dv/dt capability.

The HEXFET transistors also feature all of the well established advantages of MOSFETs such as voltage control, very fast switching, ease of paralleling and temperature stability of the electrical parameters.

They are well suited for applications such as switching power supplies, motor controls, inverters, choppers, audio amplifiers and high energy pulse circuits.

Features

- Repetitive Avalanche Ratings
- Dynamic dv/dt Rating
- Hermetically Sealed
- Simple Drive Requirements
- Ease of Paralleling

Product Summary N-Channel

Characteristic	IRF034 thru IRFAG50	Units
BV _{DSS}	60 to 1000	V
R _{DS(on)}	0.022 to 6.5	Ω
I _D	1.5 to 45	A

Product Summary P-Channel

Characteristic	IRF9130 and IRF9240	Units
BV _{DSS}	-100 and -200	V
R _{DS(on)}	0.20 and 0.80	Ω
I _D	-6.5 and -18	A

CASE STYLE AND DIMENSIONS

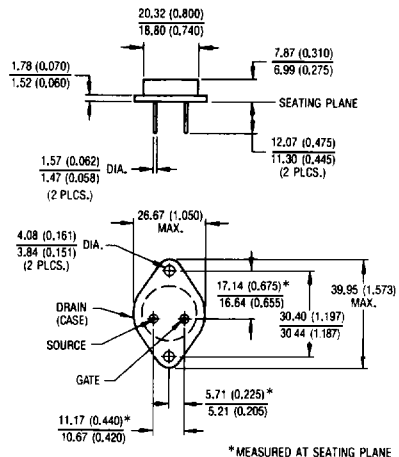
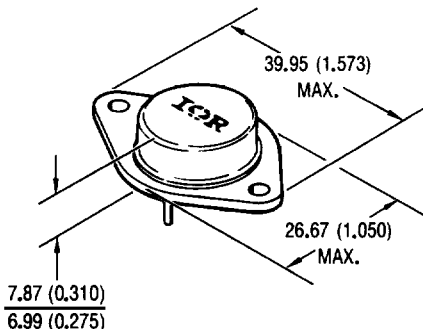

Conforms to JEDEC Outline TO-204AA & TO-204AE (TO-3)
Dimensions in Millimeters and (Inches)



N-Channel — Absolute Maximum Ratings

Parameter	Part Number				Units
	IRF034	IRF044	IRF054	IRF130	
$I_D @ V_{GS} = 0V, T_C = 25^\circ C$ Continuous Drain Current	25	44	45*	14	A
$I_D @ V_{GS} = 0V, T_C = 100^\circ C$ Continuous Drain Current	16	27	31	9.0	
I_{DM} Pulsed Drain Current ①	100	176	220	56	
$P_D @ T_C = 25^\circ C$ Max. Power Dissipation	75	125	150	75	W
Linear Derating Factor	0.60	1.0	1.2	0.60	W/K ②
V_{GS} Gate-to-Source Voltage	±20				V
E_{AS} Single Pulse Avalanche Energy ② (See Fig. 12)	19	340	480	75	mJ
I_{AR} Avalanche Current ① (See E_{AR})	—	—	—	14	A
E_{AR} Repetitive Avalanche Energy ① (See Fig. 15)	—	—	—	7.5	mJ
dv/dt Peak Diode Recovery dv/dt ③ (See Fig. 15)	4.5	4.5	4.5	5.5	V/ns
T_J T_{STG} Operating Junction and Storage Temperature Range	-55 to 150				°C
Lead Temperature	300 (0.63 in. (1.6 mm) from case for 10s)				
Weight	11.5 (typical)				

* Current limited by pin diameter

N-Channel — Absolute Maximum Ratings (continued)

Parameter	Part Number				Units
	IRF140	IRF150	IRF230	IRF240	
$I_D @ V_{GS} = 0V, T_C = 25^\circ C$ Continuous Drain Current	28	38	9.0	18	A
$I_D @ V_{GS} = 0V, T_C = 100^\circ C$ Continuous Drain Current	20	24	6.0	11	
I_{DM} Pulsed Drain Current ①	112	152	36	72	
$P_D @ T_C = 25^\circ C$ Max. Power Dissipation	125	150	75	125	W
Linear Derating Factor	1.0	1.2	0.6	1.0	W/K ②
V_{GS} Gate-to-Source Voltage	±20				V
E_{AS} Single Pulse Avalanche Energy ② (See Fig. 12)	250	150	54	450	mJ
I_{AR} Avalanche Current ① (See E_{AR})	28	38	9.0	18	A
E_{AR} Repetitive Avalanche Energy ① (See Fig. 15)	12.5	15	7.5	12.5	mJ
dv/dt Peak Diode Recovery dv/dt ③ (See Fig. 15)	5.5	5.5	5.0	5.0	V/ns
T_J T_{STG} Operating Junction and Storage Temperature Range	-55 to 150				°C
Lead Temperature	300 (0.63 in. (1.6 mm) from case for 10s)				
Weight	11.5 (typical)				

Notes – See page I-34.

N-Channel — Absolute Maximum Ratings (continued)

Parameter	Part Number				Units
	IRF250	IRF330	IRF340	IRF350	
$I_D @ V_{GS} = 0V,$ $T_C = 25^\circ C$	30	5.5	10	14	A
$I_D @ V_{GS} = 0V,$ $T_C = 100^\circ C$	19	3.5	6.0	9.0	
I_{DM}	120	22	40	56	
$P_D @ T_C = 25^\circ C$	150	75	125	150	W
	1.2	0.6	1.0	1.2	W/K ^⑤
V_{GS}	± 20				V
E_{AS}	200	1.7	5.7	11.3	mJ
I_{AR}	30	5.5	10	14	A
E_{AR}	15	—	—	15	mJ
dv/dt	5.0	4.0	4.0	4.0	V/ns
T_J T_{STG}	-55 to 150				°C
	300 (0.63 in. (1.6 mm) from case for 10s)				
	11.5 (typical)				
	11.5 (typical)				g

N-Channel — Absolute Maximum Ratings (continued)

Parameter	Part Number				Units
	IRF360	IRF430	IRF440	IRF450	
$I_D @ V_{GS} = 0V,$ $T_C = 25^\circ C$	25	4.5	8.0	12	A
$I_D @ V_{GS} = 0V,$ $T_C = 100^\circ C$	16	3.0	5.0	7.75	
I_{DM}	100	18	32	48	
$P_D @ T_C = 25^\circ C$	300	75	125	150	W
	2.4	0.6	1.0	1.2	W/K ^⑤
V_{GS}	± 20				V
E_{AS}	980	1.1	3.6	8.0	mJ
I_{AR}	25	4.5	8.0	12	A
E_{AR}	30	—	—	—	mJ
dv/dt	4.0	3.5	3.5	3.5	V/ns
T_J T_{STG}	-55 to 150				°C
	300 (0.63 in. (1.6 mm) from case for 10s)				
	11.5 (typical)				
	11.5 (typical)				g

Notes — See page I-34.

N-Channel — Absolute Maximum Ratings (continued)

Parameter	Part Number				Units
	IRF460	IRFAC30	IRFAC40	IRFAE30	
$I_D @ V_{GS} = 0V,$ $T_C = 25^\circ C$	21	3.6	6.2	3.1	A
$I_D @ V_{GS} = 0V,$ $T_C = 100^\circ C$	14	2.3	3.9	2.0	
I_{DM}	84	14	25	12	
$P_D @ T_C = 25^\circ C$	300	75	125	75	W
	2.4	0.6	1.0	0.6	W/K ^⑤
V_{GS}	±20				V
E_{AS}	1200	180	570	100	mJ
I_{AR}	21	3.6	6.2	3.1	A
E_{AR}	30	7.5	12.5	7.5	mJ
dv/dt	3.5	3.0	3.0	2.0	V/ns
T_J T_{STG}	-55 to 150				°C
	300 (0.63 in. (1.6 mm) from case for 10s)				
	11.5 (typical)				
					g

N-Channel — Absolute Maximum Ratings (continued)

Parameter	Part Number				Units
	IRFAE40	IRFAE50	IRFAF30	IRFAF40	
$I_D @ V_{GS} = 0V,$ $T_C = 25^\circ C$	4.8	7.1	2.0	4.3	A
$I_D @ V_{GS} = 0V,$ $T_C = 100^\circ C$	3.0	4.5	1.7	2.7	
I_{DM}	19	28	8.0	17	
$P_D @ T_C = 25^\circ C$	125	150	75	125	W
	1.0	1.2	0.6	1.0	W/K ^⑤
V_{GS}	±20				V
E_{AS}	550	830	100	530	mJ
I_{AR}	4.8	7.1	2.0	4.3	A
E_{AR}	12.5	15	7.5	12.5	mJ
dv/dt	2.0	2.0	1.5	1.5	V/ns
T_J T_{STG}	-55 to 150				°C
	300 (0.63 in. (1.6 mm) from case for 10s)				
	11.5 (typical)				
					g

Notes — See page I-34.

**N-Channel — Absolute Maximum Ratings (continued)**

Parameter	Part Number				Units	
	IRFAF50	IRFAG30	IRFAG40	IRFAG50		
$I_D @ V_{GS} = 0V,$ $T_C = 25^\circ C$	6.2	2.3	3.9	5.6	A	
$I_D @ V_{GS} = 0V,$ $T_C = 100^\circ C$	4.0	1.5	2.5	3.5		
I_{DM}	25	9.2	16	22		
$P_D @ T_C = 25^\circ C$	150	75	125	150	W	
	Linear Derating Factor	1.2	0.6	1.0	1.2	W/K [Ⓢ]
V_{GS}	Gate-to-Source Voltage	± 20				V
EAS	Single Pulse Avalanche Energy [Ⓐ] (See Fig. 12)	870	110	530	860	mJ
I_{AR}	Avalanche Current [Ⓐ] (See EAS)	6.2	2.3	3.9	5.6	A
EAS	Repetitive Avalanche Energy [Ⓐ] (See Fig. 15)	15	7.5	12.5	15	mJ
dv/dt	Peak Diode Recovery dv/dt [Ⓢ] (See Fig. 15)	1.5	1.0	1.0	1.0	V/ns
T_J T_{STG}	Operating Junction and Storage Temperature Range	-55 to 150				°C
	Lead Temperature	300 (0.63 in. (1.6 mm) from case for 10s)				
	Weight	11.5 (typical)				

P-Channel — Absolute Maximum Ratings

Parameter	Part Number				Units	
	IRF9130	IRF9140	IRF9230	IRF9240		
$I_D @ V_{GS} = 0V,$ $T_C = 25^\circ C$	-11	-18	-6.5	-11	A	
$I_D @ V_{GS} = 0V,$ $T_C = 100^\circ C$	-7.0	-11	-4.0	-7.0		
I_{DM}	-50	-72	-28	-44		
$P_D @ T_C = 25^\circ C$	75	125	75	125	W	
	Linear Derating Factor	0.6	1.0	0.6	1.0	W/K [Ⓢ]
V_{GS}	Gate-to-Source Voltage	± 20				V
EAS	Single Pulse Avalanche Energy [Ⓐ] (See Fig. 12)	81	500	66	500	mJ
I_{AR}	Avalanche Current [Ⓐ] (See EAS)	-11	-18	-6.5	-11	A
EAS	Repetitive Avalanche Energy [Ⓐ] (See Fig. 15)	7.5	12.5	7.5	12.5	mJ
dv/dt	Peak Diode Recovery dv/dt [Ⓢ] (See Fig. 15)	-5.5	-5.5	-5.0	-5.0	V/ns
T_J T_{STG}	Operating Junction and Storage Temperature Range	-55 to 150				°C
	Lead Temperature	300 (0.63 in. (1.6 mm) from case for 10s)				
	Weight	11.5 (typical)				

Notes – See page I-34.



Electrical Characteristics @ $T_C = 25^\circ\text{C}$ (Unless Otherwise Specified) continued

Parameter		Part Number	Min.	Typ.	Max.	Units	Test Conditions
BV _{DSS} Drain-to-Source Breakdown Voltage	N-Channel	IRF034	60	—	—	V	V _{GS} = 0V, I _D = 1.0 mA
		IRF044	60	—	—		
		IRF054	60	—	—		
		IRF130	100	—	—		
		IRF140	100	—	—		
		IRF150	100	—	—		
		IRF230	200	—	—		
		IRF240	200	—	—		
		IRF250	200	—	—		
		IRF330	400	—	—		
		IRF340	400	—	—		
		IRF350	400	—	—		
		IRF360	400	—	—		
		IRF430	500	—	—		
		IRF440	500	—	—		
		IRF450	500	—	—		
		IRF460	500	—	—		
		IRFAC30	600	—	—		
		IRFAC40	600	—	—		
		IRFAE30	800	—	—		
		IRFAE40	800	—	—		
		IRFAE50	800	—	—		
		IRFAF30	900	—	—		
	IRFAF40	900	—	—			
	IRFAF50	900	—	—			
	IRFAG30	1000	—	—			
IRFAG40	1000	—	—				
IRFAG50	1000	—	—				
P-Channel	IRF9130	-100	—	—	V _{GS} = 0V, I _D = -1.0 mA		
	IRF9140	-100	—	—			
	IRF9230	-200	—	—			
	IRF9240	-200	—	—			

Notes – See page I-34.



Electrical Characteristics @ $T_C = 25^\circ\text{C}$ (Unless Otherwise Specified) continued

Parameter		Part Number	Min.	Typ.	Max.	Units	Test Conditions
$\Delta BV_{DSS}/\Delta T_J$ Temperature Coefficient of Breakdown Voltage	N-Channel	IRF034	—	0.68	—	V/°C	Reference to 25°C, $I_D = 1.0\text{ mA}$
		IRF044	—	0.68	—		
		IRF054	—	0.68	—		
		IRF130	—	0.13	—		
		IRF140	—	0.13	—		
		IRF150	—	0.13	—		
		IRF230	—	0.29	—		
		IRF240	—	0.29	—		
		IRF250	—	0.29	—		
		IRF330	—	0.46	—		
		IRF340	—	0.46	—		
		IRF350	—	0.46	—		
		IRF360	—	0.46	—		
		IRF430	—	0.78	—		
		IRF440	—	0.78	—		
		IRF450	—	0.78	—		
		IRF460	—	0.78	—		
		IRFAC30	—	0.70	—		
		IRFAC40	—	0.70	—		
		IRFAE30	—	0.98	—		
		IRFAE40	—	0.98	—		
		IRFAE50	—	0.98	—		
		IRFAF30	—	1.2	—		
	IRFAF40	—	1.2	—			
	IRFAF50	—	1.2	—			
	IRFAG30	—	1.4	—			
	IRFAG40	—	1.4	—			
IRFAG50	—	1.4	—				
P-Channel	IRF9130	—	-0.087	—	Reference to 25°C, $I_D = -1.0\text{ mA}$		
	IRF9140	—	-0.087	—			
	IRF9230	—	-0.20	—			
	IRF9240	—	-0.20	—			

Notes – See page I-34.

IRF Series Devices



Electrical Characteristics @ T_C = 25°C (Unless Otherwise Specified) continued

Parameter		Part Number	Min.	Typ.	Max.	Units	Test Conditions
R _{DS(on)} Static Drain-to-Source On-State Resistance ④	N-Channel	IRF034	—	—	0.050	Ω	I _D = 16A
			—	—	0.058		I _D = 25A
		IRF044	—	—	0.028		I _D = 27A
			—	—	0.032		I _D = 44A
		IRF054	—	—	0.022		I _D = 31A
			—	—	0.025		I _D = 45A
		IRF130	—	—	0.18		I _D = 9.0A
			—	—	0.21		I _D = 14A
		IRF140	—	—	0.077		I _D = 20A
			—	—	0.089		I _D = 28A
		IRF150	—	—	0.055		I _D = 24A
			—	—	0.065		I _D = 38A
		IRF230	—	—	0.40		I _D = 6.0A
			—	—	0.49		I _D = 9.0A
		IRF240	—	—	0.18		I _D = 11A
			—	—	0.21		I _D = 18A
		IRF250	—	—	0.085		I _D = 19A
			—	—	0.090		I _D = 30A
		IRF330	—	—	1.00		I _D = 3.5A
			—	—	1.22		I _D = 5.5A
		IRF340	—	—	0.55		I _D = 6.0A
			—	—	0.63		I _D = 10A
		IRF350	—	—	0.300		I _D = 9.0A
			—	—	0.400		I _D = 14A
		IRF360	—	—	0.20		I _D = 16A
			—	—	0.23		I _D = 25A
		IRF430	—	—	1.50		I _D = 3.0A
			—	—	1.80		I _D = 4.5A
		IRF440	—	—	0.85		I _D = 5.0A
			—	—	0.98		I _D = 8.0A
		IRF450	—	—	0.400		I _D = 7.75A
			—	—	0.500		I _D = 12A
		IRF460	—	—	0.27		I _D = 14A
			—	—	0.31		I _D = 21A
		IRFAC30	—	—	2.2		I _D = 2.3A
			—	—	2.5		I _D = 3.6A
		IRFAC40	—	—	1.2		I _D = 3.9A
			—	—	1.4		I _D = 6.2A
		IRFAE30	—	—	3.2		I _D = 2.0A
			—	—	3.7		I _D = 3.1A
		IRFAE40	—	—	2.0		I _D = 3.0A
			—	—	2.3		I _D = 4.8A
		IRFAE50	—	—	1.2		I _D = 4.5A
			—	—	1.4		I _D = 7.1A
		IRFAF30	—	—	4.0		I _D = 1.7A
			—	—	4.6		I _D = 2.0A
		IRFAF40	—	—	2.5		I _D = 2.7A
			—	—	2.9		I _D = 4.3A
		IRFAF50	—	—	1.6		I _D = 4.0A
			—	—	1.85		I _D = 6.2A
		IRFAG30	—	—	5.6		I _D = 1.5A
			—	—	6.5		I _D = 2.3A
IRFAG40	—	—	3.5	I _D = 2.5A			
	—	—	4.0	I _D = 3.9A			
IRFAG50	—	—	2.0	I _D = 3.5A			
	—	—	2.3	I _D = 5.6A			
P-Channel	IRF9130	—	—	0.3	I _D = -7.0A		
		—	—	0.35	I _D = -11A		
	IRF9140	—	—	0.2	I _D = -11A		
		—	—	0.23	I _D = -18A		
	IRF9230	—	—	0.80	I _D = -4.0A		
		—	—	0.92	I _D = -6.5A		
	IRF9240	—	—	0.5	I _D = -7.0A		
		—	—	0.58	I _D = -11A		

Notes – See page I-34.



Electrical Characteristics @ T_C = 25°C (Unless Otherwise Specified) continued

Parameter			Part Number	Min.	Typ.	Max.	Units	Test Conditions
V _{GS(th)}	Gate Threshold Voltage	N-Channel	ALL	2.0	—	4.0	V	V _{DS} = V _{GS} , I _D = 250 mA
		P-Channel	ALL	-2.0	—	-4.0		V _{DS} = V _{GS} , I _D = -250 mA
g _{fs}	Forward Transconductance	N-Channel	IRF034	9.3	—	—	S (Ω)	I _{DS} = 16A
			IRF044	17	—	—		I _{DS} = 27A
			IRF054	20	—	—		I _{DS} = 31A
			IRF130	4.6	—	—		I _{DS} = 9.0A
			IRF140	9.1	—	—		I _{DS} = 20A
			IRF150	9.0	—	—		I _{DS} = 24A
			IRF230	3.0	—	—		I _{DS} = 6.0A
			IRF240	6.1	—	—		I _{DS} = 11A
			IRF250	9.0	—	—		I _{DS} = 19A
			IRF330	2.9	—	—		I _{DS} = 3.5A
			IRF340	4.9	—	—		I _{DS} = 6.0A
			IRF350	6.0	—	—		I _{DS} = 9.0A
			IRF360	14	—	—		I _{DS} = 16A
			IRF430	2.7	—	—		I _{DS} = 3.0A
			IRF440	4.7	—	—		I _{DS} = 5.0A
			IRF450	5.5	—	—		I _{DS} = 7.75A
			IRF460	13	—	—		I _{DS} = 14A
			IRFAC30	2.4	—	—		I _{DS} = 2.3A
			IRFAC40	4.7	—	—		I _{DS} = 3.9A
			IRFAE30	2.5	—	—		I _{DS} = 2.0A
			IRFAE40	3.9	—	—		I _{DS} = 3.0A
			IRFAE50	5.9	—	—		I _{DS} = 4.5A
			IRFAF30	2.3	—	—		I _{DS} = 1.7A
			IRFAF40	3.6	—	—		I _{DS} = 2.7A
		IRFAF50	4.9	—	—	I _{DS} = 4.0A		
		IRFAG30	2.1	—	—	I _{DS} = 1.5A		
		IRFAG40	3.3	—	—	I _{DS} = 2.5A		
		IRFAG50	5.2	—	—	I _{DS} = 3.5A		
		P-Channel	IRF9130	3.0	—	—	I _{DS} = -7.0A	
			IRF9140	6.2	—	—	I _{DS} = -11A	
			IRF9230	2.0	—	—	I _{DS} = -4.0A	
			IRF9240	4.0	—	—	I _{DS} = -7.0A	
I _{DSS}	Zero Gate Voltage Drain Current	N-Channel	ALL	—	—	25	μA	V _{DS} = 0.8 x Max. Rating V _{GS} = 0V
		P-Channel	ALL	—	—	-25		V _{DS} = 0.8 x Max. Rating V _{GS} = 0V, T _J = 125°C
I _{DSS}	Zero Gate Voltage Drain Current	N-Channel	ALL	—	—	250	μA	V _{DS} = 0.8 x Max. Rating V _{GS} = 0V, T _J = 125°C
		P-Channel	ALL	—	—	-250		V _{DS} = 0.8 x Max. Rating V _{GS} = 0V, T _J = 125°C
I _{GSS}	Gate-to-Source Leakage Forward	N-Channel	ALL	—	—	100	nA	V _{GS} = 20V
		P-Channel	ALL	—	—	-100		V _{GS} = -20V
I _{GSS}	Gate-to-Source Leakage Reverse	N-Channel	ALL	—	—	-100	nA	V _{GS} = -20V
		P-Channel	ALL	—	—	100		V _{GS} = 20V

Notes – See page I-34.



Electrical Characteristics @ $T_C = 25^\circ\text{C}$ (Unless Otherwise Specified) continued

Parameter		Part Number	Min.	Typ.	Max.	Units	Test Conditions
Q_g Total Gate Charge	N-Channel	IRF034	21	—	47	nC	$I_D = 25A$
		IRF044	39	—	88		$I_D = 44A$
		IRF054	80	—	180		$I_D = 45A$
		IRF130	12	—	35		$I_D = 14A$
		IRF140	30	—	59		$I_D = 28A$
		IRF150	50	—	125		$I_D = 38A$
		IRF230	16	—	39		$I_D = 9.0A$
		IRF240	32	—	60		$I_D = 18A$
		IRF250	55	—	115		$I_D = 30A$
		IRF330	17	—	39		$I_D = 5.5A$
		IRF340	32	—	65		$I_D = 10A$
		IRF350	52	—	110		$I_D = 14A$
		IRF360	96	—	210		$I_D = 25A$
		IRF430	16	—	40		$I_D = 4.5A$
		IRF440	27.3	—	68.5		$I_D = 8.0A$
		IRF450	55	—	120		$I_D = 12A$
		IRF460	84	—	190		$I_D = 21A$
		IRFAC30	16	—	38		$I_D = 3.6A$
		IRFAC40	26	—	60		$I_D = 6.2A$
		IRFAE30	30	—	69		$I_D = 3.1A$
		IRFAE40	48	—	110		$I_D = 4.8A$
		IRFAE50	84	—	190		$I_D = 7.1A$
		IRFAF30	29	—	66		$I_D = 2.0A$
		IRFAF40	53	—	120		$I_D = 4.3A$
	IRFAF50	80	—	180	$I_D = 6.2A$		
	IRFAG30	30	—	68	$I_D = 2.3A$		
	IRFAG40	53	—	120	$I_D = 3.9A$		
	IRFAG50	88	—	200	$I_D = 5.6A$		
	P-Channel	IRF9130	15	—	29	$I_D = -11A$	$V_{GS} = -10V$ $V_{DS} = 0.5 \times \text{Max Rating}$
		IRF9140	31	—	60	$I_D = -18A$	
		IRF9230	8	—	31	$I_D = -6.5A$	
		IRF9240	28	—	60	$I_D = -11A$	

Notes – See page I-34.



Electrical Characteristics @ $T_C = 25^\circ\text{C}$ (Unless Otherwise Specified) continued

Parameter		Part Number	Min.	Typ.	Max.	Units	Test Conditions
Q _{gs} Gate-to-Source Charge	N-Channel	IRF034	4.4	—	10	nC	I _D = 25A
		IRF044	6.7	—	15		I _D = 44A
		IRF054	20	—	45		I _D = 45A
		IRF130	2.5	—	10		I _D = 14A
		IRF140	2.4	—	12		I _D = 28A
		IRF150	8	—	22		I _D = 38A
		IRF230	3.0	—	5.7		I _D = 9.0A
		IRF240	2.2	—	10.6		I _D = 18A
		IRF250	8	—	22		I _D = 30A
		IRF330	2.0	—	6.0		I _D = 5.5A
		IRF340	2.2	—	10		I _D = 10A
		IRF350	5.0	—	18		I _D = 14A
		IRF360	11	—	28		I _D = 25A
		IRF430	2.0	—	6.0		I _D = 4.5A
		IRF440	2.0	—	12.5		I _D = 8.0A
		IRF450	5.0	—	19		I _D = 12A
		IRF460	12	—	27		I _D = 21A
		IRFAC30	2.0	—	4.6		I _D = 3.6A
		IRFAC40	3.6	—	8.3		I _D = 6.2A
		IRFAE30	3.1	—	7.1		I _D = 3.1A
		IRFAE40	5.3	—	12		I _D = 4.8A
		IRFAE50	6.6	—	15		I _D = 7.1A
		IRFAF30	3.2	—	7.2		I _D = 2.0A
		IRFAF40	4.8	—	11		I _D = 4.3A
	IRFAF50	7.5	—	17	I _D = 6.2A		
	IRFAG30	2.5	—	6.3	I _D = 2.3A		
	IRFAG40	5.3	—	12	I _D = 3.9A		
	IRFAG50	8.8	—	20	I _D = 5.6A		
	P-Channel	IRF9130	1.0	—	7.1	I _D = -11A	
		IRF9140	3.7	—	13	I _D = -18A	
		IRF9230	0.8	—	7.0	I _D = -6.5A	
		IRF9240	3.0	—	15	I _D = -11A	

V_{GS} = 10V
 V_{DS} = 0.5 x Max. Rating
 See Fig. 6 and 14

V_{GS} = -10V
 V_{DS} = 0.5 x Max. Rating

Notes – See page I-34.



Electrical Characteristics @ T_C = 25°C (Unless Otherwise Specified) continued

Parameter		Part Number	Min.	Typ.	Max.	Units	Test Conditions
Q _{gd} Gate-to-Drain ("Miller") Charge	N-Channel	IRF034	9.7	—	22	nC	I _D = 25A
		IRF044	18	—	52		I _D = 44A
		IRF054	34	—	105		I _D = 45A
		IRF130	5.0	—	15		I _D = 14A
		IRF140	12	—	30.7		I _D = 28A
		IRF150	25	—	65		I _D = 38A
		IRF230	8.0	—	20		I _D = 9.0A
		IRF240	14	—	38		I _D = 18A
		IRF250	30	—	60		I _D = 30A
		IRF330	8.0	—	20		I _D = 5.5A
		IRF340	14	—	41		I _D = 10A
		IRF350	25	—	65		I _D = 14A
		IRF360	53	—	120		I _D = 25A
		IRF430	8.0	—	20		I _D = 4.5A
		IRF440	11	—	42		I _D = 8.0A
		IRF450	27	—	70		I _D = 12A
		IRF460	60	—	135		I _D = 21A
		IRFAC30	7.5	—	17		I _D = 3.6A
		IRFAC40	13	—	30		I _D = 6.2A
		IRFAE30	17	—	40		I _D = 3.1A
		IRFAE40	30	—	68		I _D = 4.8A
		IRFAE50	48	—	110		I _D = 7.1A
		IRFAF30	16	—	37		I _D = 2.0A
		IRFAF40	30	—	68		I _D = 4.3A
	IRFAF50	48	—	110	I _D = 6.2A		
	IRFAG30	16	—	36	I _D = 2.3A		
	IRFAG40	29	—	66	I _D = 3.9A		
	IRFAG50	48	—	110	I _D = 5.6A		
	P-Channel	IRF9130	2.0	—	21	I _D = -11A	
		IRF9140	7.0	—	35.2	I _D = -18A	
IRF9230		5.0	—	17	I _D = -6.5A		
IRF9240		4.5	—	38	I _D = -11A		

V_{GS} = 10V
 V_{DS} = 0.5 x Max. Rating
 See Fig. 6 and 14

V_{GS} = -10V
 V_{DS} = 0.5 x Max. Rating

Notes – See page I-34.



Electrical Characteristics @ T_C = 25°C (Unless Otherwise Specified) continued

Parameter		Part Number	Min.	Typ.	Max.	Units	Test Conditions
t _{d(on)} Turn-On Delay Time See Fig. 10	N-Channel	IRF034	—	—	21	ns	V _{DD} = 30V, I _D = 25A, R _G = 7.5Ω
		IRF044	—	—	23		V _{DD} = 30V, I _D = 44A, R _G = 9.1Ω
		IRF054	—	—	33		V _{DD} = 30V, I _D = 45A, R _G = 2.35Ω
		IRF130	—	—	35		V _{DD} = 50V, I _D = 14A, R _G = 7.5Ω
		IRF140	—	—	21		V _{DD} = 50V, I _D = 28A, R _G = 9.1Ω
		IRF150	—	—	35		V _{DD} = 50V, I _D = 38A, R _G = 2.35Ω
		IRF230	—	—	35		V _{DD} = 100V, I _D = 9.0A, R _G = 7.5Ω
		IRF240	—	—	20		V _{DD} = 100V, I _D = 18A, R _G = 9.1Ω
		IRF250	—	—	35		V _{DD} = 100V, I _D = 30A, R _G = 2.35Ω
		IRF330	—	—	30		V _{DD} = 200V, I _D = 5.5A, R _G = 7.5Ω
		IRF340	—	—	25		V _{DD} = 200V, I _D = 10A, R _G = 9.1Ω
		IRF350	—	—	35		V _{DD} = 200V, I _D = 14A, R _G = 2.35Ω
		IRF360	—	—	33		V _{DD} = 200V, I _D = 25A, R _G = 2.35Ω
		IRF430	—	—	30		V _{DD} = 250V, I _D = 4.5A, R _G = 7.5Ω
		IRF440	—	—	21		V _{DD} = 250V, I _D = 8.0A, R _G = 9.1Ω
		IRF450	—	—	35		V _{DD} = 250V, I _D = 12A, R _G = 2.35Ω
		IRF460	—	—	35		V _{DD} = 250V, I _D = 21A, R _G = 2.35Ω
		IRFAC30	—	—	17		V _{DD} = 300V, I _D = 3.6A, R _G = 7.5Ω
		IRFAC40	—	—	20		V _{DD} = 300V, I _D = 6.2A, R _G = 9.1Ω
		IRFAE30	—	—	23		V _{DD} = 400V, I _D = 3.1A, R _G = 7.5Ω
	IRFAE40	—	—	24	V _{DD} = 400V, I _D = 4.8A, R _G = 9.1Ω		
	IRFAE50	—	—	32	V _{DD} = 400V, I _D = 7.1A, R _G = 2.35Ω		
	IRFAF30	—	—	21	V _{DD} = 400V*, I _D = 2.0A, R _G = 7.5Ω		
	IRFAF40	—	—	24	V _{DD} = 400V*, I _D = 4.3A, R _G = 9.1Ω		
	IRFAF50	—	—	33	V _{DD} = 400V*, I _D = 6.2A, R _G = 2.35Ω		
	IRFAG30	—	—	23	V _{DD} = 400V*, I _D = 2.3A, R _G = 7.5Ω		
	IRFAG40	—	—	30	V _{DD} = 400V*, I _D = 3.9A, R _G = 9.1Ω		
	IRFAG50	—	—	30	V _{DD} = 400V*, I _D = 5.6A, R _G = 2.35Ω		
P-Channel	IRF9130	—	—	60	V _{DD} = -50V, I _D = -11A, R _G = 7.5Ω		
	IRF9140	—	—	35	V _{DD} = -50V, I _D = -18A, R _G = 9.1Ω		
	IRF9230	—	—	50	V _{DD} = -100V, I _D = -6.5A, R _G = 7.5Ω		
	IRF9240	—	—	35	V _{DD} = -100V, I _D = -11A, R _G = 9.1Ω		

*Equipment Limitation

Notes – See page I-34.



Electrical Characteristics @ T_C = 25°C (Unless Otherwise Specified) continued

Parameter		Part Number	Min.	Typ.	Max.	Units	Test Conditions
t _r Rise Time See Fig. 10	N-Channel	IRF034	—	—	110	ns	V _{DD} = 30V, I _D = 25A, R _G = 7.5Ω
		IRF044	—	—	130		V _{DD} = 30V, I _D = 44A, R _G = 9.1Ω
		IRF054	—	—	180		V _{DD} = 30V, I _D = 45A, R _G = 2.35Ω
		IRF130	—	—	80		V _{DD} = 50V, I _D = 14A, R _G = 7.5Ω
		IRF140	—	—	145		V _{DD} = 50V, I _D = 28A, R _G = 9.1Ω
		IRF150	—	—	190		V _{DD} = 50V, I _D = 38A, R _G = 2.35Ω
		IRF230	—	—	80		V _{DD} = 100V, I _D = 9.0A, R _G = 7.5Ω
		IRF240	—	—	152		V _{DD} = 100V, I _D = 18A, R _G = 9.1Ω
		IRF250	—	—	190		V _{DD} = 100V, I _D = 30A, R _G = 2.35Ω
		IRF330	—	—	40		V _{DD} = 200V, I _D = 5.5A, R _G = 7.5Ω
		IRF340	—	—	92		V _{DD} = 200V, I _D = 10A, R _G = 9.1Ω
		IRF350	—	—	190		V _{DD} = 200V, I _D = 14A, R _G = 2.35Ω
		IRF360	—	—	140		V _{DD} = 200V, I _D = 25A, R _G = 2.35Ω
		IRF430	—	—	40		V _{DD} = 250V, I _D = 4.5A, R _G = 7.5Ω
		IRF440	—	—	73		V _{DD} = 250V, I _D = 8.0A, R _G = 9.1Ω
		IRF450	—	—	190		V _{DD} = 250V, I _D = 12A, R _G = 2.35Ω
		IRF460	—	—	120		V _{DD} = 250V, I _D = 21A, R _G = 2.35Ω
		IRFAC30	—	—	20		V _{DD} = 300V, I _D = 3.6A, R _G = 7.5Ω
		IRFAC40	—	—	27		V _{DD} = 300V, I _D = 6.2A, R _G = 9.1Ω
		IRFAE30	—	—	32		V _{DD} = 400V, I _D = 3.1A, R _G = 7.5Ω
		IRFAE40	—	—	42		V _{DD} = 400V, I _D = 4.8A, R _G = 9.1Ω
		IRFAE50	—	—	68		V _{DD} = 400V, I _D = 7.1A, R _G = 2.35Ω
		IRFAF30	—	—	30		V _{DD} = 400V*, I _D = 2.0A, R _G = 7.5Ω
		IRFAF40	—	—	39		V _{DD} = 400V*, I _D = 4.3A, R _G = 9.1Ω
	IRFAF50	—	—	66	V _{DD} = 400V*, I _D = 6.2A, R _G = 2.35Ω		
	IRFAG30	—	—	42	V _{DD} = 400V*, I _D = 2.3A, R _G = 7.5Ω		
	IRFAG40	—	—	50	V _{DD} = 400V*, I _D = 3.9A, R _G = 9.1Ω		
	IRFAG50	—	—	44	V _{DD} = 400V*, I _D = 5.6A, R _G = 2.35Ω		
	P-Channel	IRF9130	—	—	140		V _{DD} = -50V, I _D = -11A, R _G = 7.5Ω
		IRF9140	—	—	85		V _{DD} = -50V, I _D = -18A, R _G = 9.1Ω
		IRF9230	—	—	100		V _{DD} = -100V, I _D = -6.5A, R _G = 7.5Ω
		IRF9240	—	—	85		V _{DD} = -100V, I _D = -11A, R _G = 9.1Ω

*Equipment Limitation

Notes – See page I-34.



Electrical Characteristics @ $T_C = 25^\circ\text{C}$ (Unless Otherwise Specified) continued

Parameter		Part Number	Min.	Typ.	Max.	Units	Test Conditions
$t_{d(off)}$ Turn-Off Delay Time See Fig. 10	N-Channel	IRF034	—	—	53	ns	$V_{DD} = 30V, I_D = 25A, R_G = 7.5\Omega$
		IRF044	—	—	81		$V_{DD} = 30V, I_D = 44A, R_G = 9.1\Omega$
		IRF054	—	—	100		$V_{DD} = 30V, I_D = 45A, R_G = 2.35\Omega$
		IRF130	—	—	60		$V_{DD} = 50V, I_D = 14A, R_G = 7.5\Omega$
		IRF140	—	—	21		$V_{DD} = 50V, I_D = 28A, R_G = 9.1\Omega$
		IRF150	—	—	170		$V_{DD} = 50V, I_D = 38A, R_G = 2.35\Omega$
		IRF230	—	—	60		$V_{DD} = 100V, I_D = 9.0A, R_G = 7.5\Omega$
		IRF240	—	—	58		$V_{DD} = 100V, I_D = 18A, R_G = 9.1\Omega$
		IRF250	—	—	170		$V_{DD} = 100V, I_D = 30A, R_G = 2.35\Omega$
		IRF330	—	—	80		$V_{DD} = 200V, I_D = 5.5A, R_G = 7.5\Omega$
		IRF340	—	—	79		$V_{DD} = 200V, I_D = 10A, R_G = 9.1\Omega$
		IRF350	—	—	170		$V_{DD} = 200V, I_D = 14A, R_G = 2.35\Omega$
		IRF360	—	—	120		$V_{DD} = 200V, I_D = 25A, R_G = 2.35\Omega$
		IRF430	—	—	80		$V_{DD} = 250V, I_D = 4.5A, R_G = 7.5\Omega$
		IRF440	—	—	72		$V_{DD} = 250V, I_D = 8.0A, R_G = 9.1\Omega$
		IRF450	—	—	170		$V_{DD} = 250V, I_D = 12A, R_G = 2.35\Omega$
		IRF460	—	—	130		$V_{DD} = 250V, I_D = 21A, R_G = 2.35\Omega$
		IRFAC30	—	—	53		$V_{DD} = 300V, I_D = 3.6A, R_G = 7.5\Omega$
		IRFAC40	—	—	83		$V_{DD} = 300V, I_D = 6.2A, R_G = 9.1\Omega$
		IRFAE30	—	—	120		$V_{DD} = 400V, I_D = 3.1A, R_G = 7.5\Omega$
		IRFAE40	—	—	170		$V_{DD} = 400V, I_D = 4.8A, R_G = 9.1\Omega$
		IRFAE50	—	—	78		$V_{DD} = 400V, I_D = 7.1A, R_G = 2.35\Omega$
		IRFAF30	—	—	140		$V_{DD} = 400V^*, I_D = 2.0A, R_G = 7.5\Omega$
		IRFAF40	—	—	170		$V_{DD} = 400V^*, I_D = 4.3A, R_G = 9.1\Omega$
	IRFAF50	—	—	200	$V_{DD} = 400V^*, I_D = 6.2A, R_G = 2.35\Omega$		
	IRFAG30	—	—	210	$V_{DD} = 400V^*, I_D = 2.3A, R_G = 7.5\Omega$		
	IRFAG40	—	—	170	$V_{DD} = 400V^*, I_D = 3.9A, R_G = 9.1\Omega$		
	IRFAG50	—	—	210	$V_{DD} = 400V^*, I_D = 5.6A, R_G = 2.35\Omega$		
	P-Channel	IRF9130	—	—	140		$V_{DD} = -50V, I_D = -11A, R_G = 7.5\Omega$
		IRF9140	—	—	85		$V_{DD} = -50V, I_D = -18A, R_G = 9.1\Omega$
IRF9230		—	—	100	$V_{DD} = -100V, I_D = -6.5A, R_G = 7.5\Omega$		
IRF9240		—	—	85	$V_{DD} = -100V, I_D = -11A, R_G = 9.1\Omega$		

*Equipment Limitation

Notes – See page I-34.



Electrical Characteristics @ $T_C = 25^\circ\text{C}$ (Unless Otherwise Specified) continued

Parameter		Part Number	Min.	Typ.	Max.	Units	Test Conditions
t_f Fall Time See Fig. 10	N-Channel	IRF034	—	—	80	ns	$V_{DD} = 30V, I_D = 25A, R_G = 7.5\Omega$
		IRF044	—	—	79		$V_{DD} = 30V, I_D = 44A, R_G = 9.1\Omega$
		IRF054	—	—	100		$V_{DD} = 30V, I_D = 45A, R_G = 2.35\Omega$
		IRF130	—	—	45		$V_{DD} = 50V, I_D = 14A, R_G = 7.5\Omega$
		IRF140	—	—	105		$V_{DD} = 50V, I_D = 28A, R_G = 9.1\Omega$
		IRF150	—	—	130		$V_{DD} = 50V, I_D = 38A, R_G = 2.35\Omega$
		IRF230	—	—	40		$V_{DD} = 100V, I_D = 9.0A, R_G = 7.5\Omega$
		IRF240	—	—	67		$V_{DD} = 100V, I_D = 18A, R_G = 9.1\Omega$
		IRF250	—	—	130		$V_{DD} = 100V, I_D = 30A, R_G = 2.35\Omega$
		IRF330	—	—	35		$V_{DD} = 200V, I_D = 5.5A, R_G = 7.5\Omega$
		IRF340	—	—	58		$V_{DD} = 200V, I_D = 10A, R_G = 9.1\Omega$
		IRF350	—	—	130		$V_{DD} = 200V, I_D = 14A, R_G = 2.35\Omega$
		IRF360	—	—	99		$V_{DD} = 200V, I_D = 25A, R_G = 2.35\Omega$
		IRF430	—	—	30		$V_{DD} = 250V, I_D = 4.5A, R_G = 7.5\Omega$
		IRF440	—	—	51		$V_{DD} = 250V, I_D = 8.0A, R_G = 9.1\Omega$
		IRF450	—	—	130		$V_{DD} = 250V, I_D = 12A, R_G = 2.35\Omega$
		IRF460	—	—	98		$V_{DD} = 250V, I_D = 21A, R_G = 2.35\Omega$
		IRFAC30	—	—	21		$V_{DD} = 300V, I_D = 3.6A, R_G = 7.5\Omega$
		IRFAC40	—	—	30		$V_{DD} = 300V, I_D = 6.2A, R_G = 9.1\Omega$
		IRFAE30	—	—	44		$V_{DD} = 400V, I_D = 3.1A, R_G = 7.5\Omega$
		IRFAE40	—	—	44		$V_{DD} = 400V, I_D = 4.8A, R_G = 9.1\Omega$
		IRFAE50	—	—	24		$V_{DD} = 400V, I_D = 7.1A, R_G = 2.35\Omega$
		IRFAF30	—	—	47		$V_{DD} = 400V^*, I_D = 2.0A, R_G = 7.5\Omega$
		IRFAF40	—	—	44		$V_{DD} = 400V^*, I_D = 4.3A, R_G = 9.1\Omega$
	IRFAF50	—	—	57	$V_{DD} = 400V^*, I_D = 6.2A, R_G = 2.35\Omega$		
	IRFAG30	—	—	60	$V_{DD} = 400V^*, I_D = 2.3A, R_G = 7.5\Omega$		
	IRFAG40	—	—	50	$V_{DD} = 400V^*, I_D = 3.9A, R_G = 9.1\Omega$		
	IRFAG50	—	—	60	$V_{DD} = 400V^*, I_D = 5.6A, R_G = 2.35\Omega$		
	P-Channel	IRF9130	—	—	140	$V_{DD} = -50V, I_D = -11A, R_G = 7.5\Omega$	
		IRF9140	—	—	65	$V_{DD} = -50V, I_D = -18A, R_G = 9.1\Omega$	
IRF9230		—	—	80	$V_{DD} = -100V, I_D = -6.5A, R_G = 7.5\Omega$		
IRF9240		—	—	65	$V_{DD} = -100V, I_D = -11A, R_G = 9.1\Omega$		

*Equipment Limitation

Notes – See page I-34.

Electrical Characteristics @ $T_C = 25^\circ\text{C}$ (Unless Otherwise Specified) continued

Parameter		Part Number	Min.	Typ.	Max.	Units	Test Conditions	
L_D Internal Drain Inductance	N-Channel	All	—	5.0	—	nH	Measured from the drain lead, 6 mm (0.15 in.) from package to center of die.	Modified MOSFET symbol showing the internal inductances.
L_S Internal Source Inductance			—	13	—			
L_D Internal Drain Inductance	P-Channel	All	—	5.0	—	nH	Measured from the drain lead, 6 mm (0.15 in.) from package to center of die.	Modified MOSFET symbol showing the internal inductances.
L_S Internal Source Inductance			—	13	—			
C_{iss} Input Capacitance	N-Channel	IRF034	—	1300	—	pF	V _{GS} = 0V, V _{DS} = 25V f = 1.0 MHz See Fig. 5	
		IRF044	—	2400	—			
		IRF054	—	4600	—			
		IRF130	—	650	—			
		IRF140	—	1660	—			
		IRF150	—	3700	—			
		IRF230	—	600	—			
		IRF240	—	1300	—			
		IRF250	—	3500	—			
		IRF330	—	620	—			
		IRF340	—	1400	—			
		IRF350	—	2600	—			
		IRF360	—	4200	—			
		IRF430	—	610	—			
		IRF440	—	1300	—			
		IRF450	—	2700	—			
		IRF460	—	4300	—			
		IRFAC30	—	630	—			
		IRFAC40	—	1300	—			
		IRFAE30	—	950	—			
		IRFAE40	—	1700	—			
		IRFAE50	—	2800	—			
	IRFAF30	—	1000	—				
	IRFAF40	—	1500	—				
	IRFAF50	—	2700	—				
	IRFAG30	—	980	—				
	IRFAG40	—	1700	—				
	IRFAG50	—	2400	—				
	P-Channel	IRF9130	—	860	—	pF	V _{GS} = 0V, V _{DS} = -25V f = 1.0 MHz See Fig. 5	
		IRF9140	—	1400	—			
		IRF9230	—	700	—			
		IRF9240	—	1200	—			

Notes – See page I-34.



Electrical Characteristics @ $T_C = 25^\circ\text{C}$ (Unless Otherwise Specified) continued

Parameter		Part Number	Min.	Typ.	Max.	Units	Test Conditions
C_{oss} Output Capacitance	N-Channel	IRF034	—	650	—	pF	$V_{GS} = 0V, V_{DS} = 25V$ $f = 1.0\text{ MHz}$ See Fig. 5
		IRF044	—	1100	—		
		IRF054	—	2000	—		
		IRF130	—	250	—		
		IRF140	—	550	—		
		IRF150	—	1100	—		
		IRF230	—	250	—		
		IRF240	—	400	—		
		IRF250	—	700	—		
		IRF330	—	200	—		
		IRF340	—	350	—		
		IRF350	—	680	—		
		IRF360	—	900	—		
		IRF430	—	135	—		
		IRF440	—	310	—		
		IRF450	—	600	—		
		IRF460	—	1000	—		
		IRFAC30	—	80	—		
		IRFAC40	—	160	—		
		IRFAE30	—	170	—		
		IRFAE40	—	230	—		
		IRFAE50	—	400	—		
		IRFAF30	—	200	—		
	IRFAF40	—	190	—			
	IRFAF50	—	500	—			
	IRFAG30	—	140	—			
	IRFAG40	—	250	—			
IRFAG50	—	240	—				
P-Channel	IRF9130	—	350	—	$V_{GS} = 0V, V_{DS} = -25V$ $f = 1.0\text{ MHz}$ See Fig. 5		
	IRF9140	—	600	—			
	IRF9230	—	200	—			
	IRF9240	—	570	—			

Notes – See page I-34.



Electrical Characteristics @ $T_C = 25^\circ\text{C}$ (Unless Otherwise Specified) continued

Parameter		Part Number	Min.	Typ.	Max.	Units	Test Conditions
C_{rss} Reverse Transfer Capacitance	N-Channel	IRF034	—	100	—	pF	$V_{GS} = 0V, V_{DS} = 25V$ $f = 1.0\text{ MHz}$ See Fig. 5
		IRF044	—	230	—		
		IRF054	—	340	—		
		IRF130	—	44	—		
		IRF140	—	120	—		
		IRF150	—	200	—		
		IRF230	—	80	—		
		IRF240	—	130	—		
		IRF250	—	110	—		
		IRF330	—	75	—		
		IRF340	—	230	—		
		IRF350	—	250	—		
		IRF360	—	400	—		
		IRF430	—	65	—		
		IRF440	—	120	—		
		IRF450	—	240	—		
		IRF460	—	250	—		
		IRFAC30	—	15	—		
		IRFAC40	—	45	—		
		IRFAE30	—	80	—		
		IRFAE40	—	96	—		
		IRFAE50	—	200	—		
	IRFAF30	—	98	—			
	IRFAF40	—	72	—			
	IRFAF50	—	200	—			
	IRFAG30	—	50	—			
IRFAG40	—	100	—				
IRFAG50	—	80	—				
P-Channel	IRF9130	—	125	—	$V_{GS} = 0V, V_{DS} = -25V$ $f = 1.0\text{ MHz}$ See Fig. 5		
	IRF9140	—	200	—			
	IRF9230	—	40	—			
	IRF9240	—	81	—			

Notes – See page I-34.



Electrical Characteristics @ $T_C = 25^\circ\text{C}$ (Unless Otherwise Specified) continued

Parameter		Part Number	Min.	Typ.	Max.	Units	Test Conditions
C _{DC} Drain-to-Case Capacitance	N-Channel	ALL	—	12	—	pF	V _{GS} = 0V, V _{DS} = 25V f = 1.0 MHz See Fig. 5
	P-Channel	ALL	—	12	—		V _{GS} = 0V, V _{DS} = -25V f = 1.0 MHz See Fig. 5

Notes – See page I-34.



Source-Drain Diode Ratings and Characteristics

Parameter		Part Number	Min.	Typ.	Max.	Units	Test Conditions
I _S Continuous Source Current (Body Diode)	N-Channel	IRF034	—	—	25	A	Modified MOSFET symbol showing the integral reverse p-n junction rectifier.
		IRF044	—	—	44		
		IRF054	—	—	45*		
		IRF130	—	—	14		
		IRF140	—	—	28		
		IRF150	—	—	38		
		IRF230	—	—	9.0		
		IRF240	—	—	18		
		IRF250	—	—	30		
		IRF330	—	—	5.5		
		IRF340	—	—	10		
		IRF350	—	—	14		
		IRF360	—	—	25		
		IRF430	—	—	4.5		
		IRF440	—	—	8.0		
		IRF450	—	—	12		
		IRF460	—	—	21		
		IRFAC30	—	—	3.6		
		IRFAC40	—	—	6.2		
		IRFAE30	—	—	3.1		
		IRFAE40	—	—	4.8		
		IRFAE50	—	—	7.1		
		IRFAF30	—	—	2.8		
		IRFAF40	—	—	4.3		
	IRFAF50	—	—	6.2			
	IRFAG30	—	—	2.3			
	IRFAG40	—	—	3.9			
	IRFAG50	—	—	5.6			
	P-Channel	IRF9130	—	—	-11		
		IRF9140	—	—	-18		
		IRF9230	—	—	-6.5		
		IRF9240	—	—	-11		

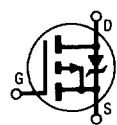

*I_S current limited by pin diameter

Notes – See page I-34.

Source-Drain Diode Ratings and Characteristics (continued)

Parameter		Part Number	Min.	Typ.	Max.	Units	Test Conditions
ISM Pulse Source Current (Body Diode) ①	N-Channel	IRF034	—	—	100	A	Modified MOSFET symbol showing the integral reverse p-n junction rectifier.
		IRF044	—	—	176		
		IRF054	—	—	220		
		IRF130	—	—	56		
		IRF140	—	—	112		
		IRF150	—	—	152		
		IRF230	—	—	36		
		IRF240	—	—	72		
		IRF250	—	—	120		
		IRF330	—	—	22		
		IRF340	—	—	40		
		IRF350	—	—	56		
		IRF360	—	—	100		
		IRF430	—	—	18		
		IRF440	—	—	32		
		IRF450	—	—	48		
		IRF460	—	—	84		
		IRFAC30	—	—	14		
		IRFAC40	—	—	25		
		IRFAE30	—	—	12		
		IRFAE40	—	—	19		
		IRFAE50	—	—	28		
		IRFAF30	—	—	8.0		
		IRFAF40	—	—	17		
	IRFAF50	—	—	25			
	IRFAG30	—	—	9.2			
	IRFAG40	—	—	16			
	IRFAG50	—	—	22			
	P-Channel	IRF9130	—	—	-50		
		IRF9140	—	—	-72		
		IRF9230	—	—	-28		
		IRF9240	—	—	-44		



Notes – See page I-34.



Source-Drain Diode Ratings and Characteristics (continued)

Parameter		Part Number	Min.	Typ.	Max.	Units	Test Conditions
V _{SD} Diode Forward Voltage	N-Channel	IRF034	—	—	1.8	V	I _S = 25A
		IRF044	—	—	2.5		I _S = 44A
		IRF054	—	—	2.5		I _S = 45A
		IRF130	—	—	1.5		I _S = 14A
		IRF140	—	—	1.5		I _S = 28A
		IRF150	—	—	1.8		I _S = 38A
		IRF230	—	—	1.4		I _S = 9.0A
		IRF240	—	—	1.5		I _S = 18A
		IRF250	—	—	1.9		I _S = 30A
		IRF330	—	—	1.4		I _S = 5.5A
		IRF340	—	—	1.5		I _S = 10A
		IRF350	—	—	1.7		I _S = 14A
		IRF360	—	—	1.8		I _S = 25A
		IRF430	—	—	1.4		I _S = 4.5A
		IRF440	—	—	1.5		I _S = 8.0A
		IRF450	—	—	1.7		I _S = 12A
		IRF460	—	—	1.8		I _S = 21A
		IRFAC30	—	—	1.6		I _S = 3.6A
		IRFAC40	—	—	1.1		I _S = 6.2A
		IRFAE30	—	—	1.8		I _S = 3.1A
		IRFAE40	—	—	1.8		I _S = 4.8A
		IRFAE50	—	—	1.8		I _S = 7.1A
		IRFAF30	—	—	1.8		I _S = 2.0A
		IRFAF40	—	—	1.8		I _S = 4.3A
	IRFAF50	—	—	1.8	I _S = 6.2A		
	IRFAG30	—	—	1.8	I _S = 2.3A		
	IRFAG40	—	—	1.8	I _S = 3.9A		
	IRFAG50	—	—	1.8	I _S = 5.6A		
	P-Channel	IRF9130	—	—	-4.7	I _S = -11A	
		IRF9140	—	—	-4.2	I _S = -18A	
IRF9230		—	—	-6.0	I _S = -6.5A		
IRF9240		—	—	-4.6	I _S = -11A		

T_J = 25°C, V_{GS} = 0V ⊕

Notes – See page I-34.

Source-Drain Diode Ratings and Characteristics (continued)

Parameter		Part Number	Min.	Typ.	Max.	Units	Test Conditions	
t_{rr} Reverse Recovery Time	N-Channel	IRF034	—	—	220	ns	$I_F = 25A$ $T_J = 25^\circ C, di/dt \leq 100 A/\mu s$ $V_{DD} \leq 50V$	
		IRF044	—	—	220			$I_F = 44A$
		IRF054	—	—	280			$I_F = 45A$
		IRF130	—	—	300			$I_F = 14A$
		IRF140	—	—	400			$I_F = 28A$
		IRF150	—	—	500			$I_F = 38A$
		IRF230	—	—	500			$I_F = 9.0A$
		IRF240	—	—	500			$I_F = 18A$
		IRF250	—	—	950			$I_F = 30A$
		IRF330	—	—	700			$I_F = 5.5A$
		IRF340	—	—	600			$I_F = 10A$
		IRF350	—	—	1200			$I_F = 14A$
		IRF360	—	—	1000			$I_F = 25A$
		IRF430	—	—	900			$I_F = 4.5A$
		IRF440	—	—	700			$I_F = 8.0A$
		IRF450	—	—	1600			$I_F = 12A$
		IRF460	—	—	580			$I_F = 21A$
		IRFAC30	—	—	810			$I_F = 3.6A$
		IRFAC40	—	—	940			$I_F = 6.2A$
		IRFAE30	—	—	800			$I_F = 3.1A$
		IRFAE40	—	—	1300			$I_F = 4.8A$
		IRFAE50	—	—	1600			$I_F = 7.1A$
		IRFAF30	—	—	730			$I_F = 2.0A$
		IRFAF40	—	—	1100			$I_F = 4.3A$
	IRFAF50	—	—	1500	$I_F = 6.2A$			
	IRFAG30	—	—	470	$I_F = 2.3A$			
	IRFAG40	—	—	1000	$I_F = 3.9A$			
	IRFAG50	—	—	1200	$I_F = 5.6A$			
P-Channel	IRF9130	—	—	250	$I_F = -11A$	$T_J = 25^\circ C, di/dt \leq -100 A/\mu s$ $V_{DD} \leq -50V$		
	IRF9140	—	170	280	$I_F = -18A$			
	IRF9230	—	—	400	$I_F = -6.5A$			
	IRF9240	—	270	440	$I_F = -11A$			

Notes – See page I-34.

Source-Drain Diode Ratings and Characteristics (continued)

Parameter		Part Number	Min.	Typ.	Max.	Units	Test Conditions
Q _{RR} Reverse Recovery Charge	N-Channel	IRF034	—	—	9.6	μC	$I_F = 25\text{A}$
		IRF044	—	—	1.6		$I_F = 44\text{A}$
		IRF054	—	—	2.2		$I_F = 45\text{A}$
		IRF130	—	—	3.0		$I_F = 14\text{A}$
		IRF140	—	—	2.9		$I_F = 28\text{A}$
		IRF150	—	—	2.9		$I_F = 38\text{A}$
		IRF230	—	—	6.0		$I_F = 9.0\text{A}$
		IRF240	—	—	5.3		$I_F = 18\text{A}$
		IRF250	—	—	9.0		$I_F = 30\text{A}$
		IRF330	—	—	6.2		$I_F = 5.5\text{A}$
		IRF340	—	—	5.6		$I_F = 10\text{A}$
		IRF350	—	—	11		$I_F = 14\text{A}$
		IRF360	—	—	16		$I_F = 25\text{A}$
		IRF430	—	—	7.0		$I_F = 4.5\text{A}$
		IRF440	—	—	8.9		$I_F = 8.0\text{A}$
		IRF450	—	—	14		$I_F = 12\text{A}$
		IRF460	—	—	8.1		$I_F = 21\text{A}$
		IRFAC30	—	—	4.2		$I_F = 3.6\text{A}$
		IRFAC40	—	—	8.0		$I_F = 6.2\text{A}$
		IRFAE30	—	—	3.6		$I_F = 3.1\text{A}$
		IRFAE40	—	—	8.5		$I_F = 4.8\text{A}$
		IRFAE50	—	—	13		$I_F = 7.1\text{A}$
		IRFAF30	—	—	3.0		$I_F = 2.0\text{A}$
		IRFAF40	—	—	6.7		$I_F = 4.3\text{A}$
	IRFAF50	—	—	11	$I_F = 6.2\text{A}$		
	IRFAG30	—	—	1.7	$I_F = 2.3\text{A}$		
	IRFAG40	—	—	5.6	$I_F = 3.9\text{A}$		
	IRFAG50	—	—	8.4	$I_F = 5.6\text{A}$		
	P-Channel	IRF9130	—	—	3.0	μC	$I_F = -11\text{A}$
		IRF9140	—	—	3.6		$I_F = -18\text{A}$
		IRF9230	—	—	4.0		$I_F = -6.5\text{A}$
		IRF9240	—	—	7.2		$I_F = -11\text{A}$
t _{on} Forward Turn-On Time	ALL	Intrinsic turn-on time is negligible. Turn-on speed is substantially controlled by L _S + L _D					

Notes – See page I-34.



Thermal Resistance and Case Style

Parameter		Part Number	Min.	Typ.	Max.	Units	Test Conditions
R _{thJC} Junction-to-Case	N-Channel	IRF034	—	—	1.67	K/W ^⑤	
		IRF044	—	—	1.0		
		IRF054	—	—	0.83		
		IRF130	—	—	1.67		
		IRF140	—	—	1.0		
		IRF150	—	—	0.83		
		IRF230	—	—	1.67		
		IRF240	—	—	1.0		
		IRF250	—	—	0.83		
		IRF330	—	—	1.67		
		IRF340	—	—	1.0		
		IRF350	—	—	0.83		
		IRF360	—	—	0.42		
		IRF430	—	—	1.67		
		IRF440	—	—	1.0		
		IRF450	—	—	0.83		
		IRF460	—	—	0.42		
		IRFAC30	—	—	1.67		
		IRFAC40	—	—	1.0		
		IRFAE30	—	—	1.67		
		IRFAE40	—	—	1.0		
		IRFAE50	—	—	0.83		
		IRFAF30	—	—	1.67		
		IRFAF40	—	—	1.0		
	IRFAF50	—	—	0.83			
	IRFAG30	—	—	1.67			
	IRFAG40	—	—	1.0			
	IRFAG50	—	—	0.83			
	P-Channel	IRF9130	—	—	1.67		
		IRF9140	—	—	1.0		
		IRF9230	—	—	1.67		
		IRF9240	—	—	1.0		

Notes – See page I-34.



Thermal Resistance and Case Style (continued)

Parameter		Part Number	Min.	Typ.	Max.	Units	Test Conditions
R _{thCS} Case-to-Sink	N-Channel	IRF034	—	0.12	—	K/W ^⑤	Mounting surface flat, smooth, and greased.
		IRF044	—	0.12	—		
		IRF054	—	0.12	—		
		IRF130	—	0.12	—		
		IRF140	—	0.12	—		
		IRF150	—	0.12	—		
		IRF230	—	0.12	—		
		IRF240	—	0.12	—		
		IRF250	—	0.12	—		
		IRF330	—	0.12	—		
		IRF340	—	0.12	—		
		IRF350	—	0.12	—		
		IRF360	—	0.12	—		
		IRF430	—	0.12	—		
		IRF440	—	0.12	—		
		IRF450	—	0.12	—		
		IRF460	—	0.12	—		
		IRFAC30	—	0.12	—		
		IRFAC40	—	0.12	—		
		IRFAE30	—	0.12	—		
	IRFAE40	—	0.12	—			
	IRFAE50	—	0.12	—			
	IRFAF30	—	0.12	—			
	IRFAF40	—	0.12	—			
	IRFAF50	—	0.12	—			
	IRFAG30	—	0.12	—			
	IRFAG40	—	0.12	—			
	IRFAG50	—	0.12	—			
P-Channel	IRF9130	—	0.12	—			
	IRF9140	—	0.12	—			
	IRF9230	—	0.12	—			
	IRF9240	—	0.12	—			

Notes – See page I-34.





Thermal Resistance and Case Style (continued)

Parameter		Part Number	Min.	Typ.	Max.	Units	Test Conditions
R _{thJA} Junction-to-Ambient	N-Channel	IRF034	—	—	30	K/W ^⑤	Typical socket mount
		IRF044	—	—	30		
		IRF054	—	—	30		
		IRF130	—	—	30		
		IRF140	—	—	30		
		IRF150	—	—	30		
		IRF230	—	—	30		
		IRF240	—	—	30		
		IRF250	—	—	30		
		IRF330	—	—	30		
		IRF340	—	—	30		
		IRF350	—	—	30		
		IRF360	—	—	30		
		IRF430	—	—	30		
		IRF440	—	—	30		
		IRF450	—	—	30		
		IRF460	—	—	30		
		IRFAC30	—	—	30		
		IRFAC40	—	—	30		
		IRFAE30	—	—	30		
		IRFAE40	—	—	30		
		IRFAE50	—	—	30		
		IRFAF30	—	—	30		
		IRFAF40	—	—	30		
		IRFAF50	—	—	30		
		IRFAG30	—	—	30		
		IRFAG40	—	—	30		
		IRFAG50	—	—	30		
	P-Channel	IRF9130	—	—	30		
		IRF9140	—	—	30		
		IRF9230	—	—	30		
		IRF9240	—	—	30		

Notes – See page I-34.



Thermal Resistance and Case Style (continued)

Case Style	Part Number	TO-204AA	TO-204AE	
N-Channel	IRF034		X	
	IRF044		X	
	IRF054		X	
	IRF130	X		
	IRF140		X	
	IRF150		X	
	IRF230	X		
	IRF240		X	
	IRF250		X	
	IRF330	X		
	IRF340	X		
	IRF350	X		
	IRF360		X	
	IRF430	X		
	IRF440	X		
	IRF450	X		
	IRF460		X	
	IRFAC30	X		
	IRFAC40	X		
	IRFAE30	X		
	IRFAE40	X		
	IRFAE50	X		
	IRFAF30	X		
	IRFAF40	X		
	IRFAF50	X		
	IRFAG30	X		
	IRFAG40	X		
	IRFAG50	X		
	IRF9130	X		
	P-Channel	IRF9140	X	
		IRF9230	X	
		IRF9240	X	

Notes – See page I-34.



Notes:

- ① Repetitive rating: pulse width limited by max. junction temperature (See Figure 11)
- ② See Table 1 for individual devices conditions
- ③ See Table 1 for individual devices conditions
- ④ Pulse width $\leq 300 \mu\text{s}$; duty cycle $\leq 2\%$
- ⑤ $K/W = ^\circ\text{C/W}$
 $W/K = W/^\circ\text{C}$

**Table 1 — Notes ② and ③ for IRF034 to IRFAG50 — N-Channel
IRF9130 to IRF9240 — P-Channel**

Device	Note ②	Note ③
IRF034	@ $V_{DD} = 25\text{V}$, Starting $T_J = 25^\circ\text{C}$, $L \geq 35 \mu\text{H}$, $R_G = 25\Omega$, Peak $I_L = 25\text{A}$	$I_{SD} \leq 25\text{A}$, $di/dt \leq 200 \text{A}/\mu\text{s}$, $V_{DD} \leq BV_{DSS}$, $T_J \leq 150^\circ\text{C}$ Suggested $R_G = 7.5\Omega$
IRF044	@ $V_{DD} = 25\text{V}$, Starting $T_J = 25^\circ\text{C}$, $L \geq 200 \mu\text{H}$, $R_G = 25\Omega$, Peak $I_L = 44\text{A}$	$I_{SD} \leq 44\text{A}$, $di/dt \leq 250 \text{A}/\mu\text{s}$, $V_{DD} \leq BV_{DSS}$, $T_J \leq 150^\circ\text{C}$ Suggested $R_G = 9.1\Omega$
IRF054	@ $V_{DD} = 25\text{V}$, Starting $T_J = 25^\circ\text{C}$, $L \geq 280 \mu\text{H}$, $R_G = 25\Omega$, Peak $I_L = 45\text{A}$	$I_{SD} \leq 45\text{A}$, $di/dt \leq 200 \text{A}/\mu\text{s}$, $V_{DD} \leq BV_{DSS}$, $T_J \leq 150^\circ\text{C}$ Suggested $R_G = 2.35\Omega$
IRF130	@ $V_{DD} = 50\text{V}$, Starting $T_J = 25^\circ\text{C}$, $L \geq 570 \mu\text{H}$, $R_G = 25\Omega$, Peak $I_L = 14\text{A}$	$I_{SD} \leq 14\text{A}$, $di/dt \leq 140 \text{A}/\mu\text{s}$, $V_{DD} \leq BV_{DSS}$, $T_J \leq 150^\circ\text{C}$ Suggested $R_G = 7.5\Omega$
IRF140	@ $V_{DD} = 25\text{V}$, Starting $T_J = 25^\circ\text{C}$, $L \geq 480 \mu\text{H}$, $R_G = 25\Omega$, Peak $I_L = 28\text{A}$	$I_{SD} \leq 28\text{A}$, $di/dt \leq 170 \text{A}/\mu\text{s}$, $V_{DD} \leq BV_{DSS}$, $T_J \leq 150^\circ\text{C}$ Suggested $R_G = 9.1\Omega$
IRF150	@ $V_{DD} = 50\text{V}$, Starting $T_J = 25^\circ\text{C}$, $L \geq 160 \mu\text{H}$, $R_G = 25\Omega$, Peak $I_L = 38\text{A}$	$I_{SD} \leq 38\text{A}$, $di/dt \leq 300 \text{A}/\mu\text{s}$, $V_{DD} \leq BV_{DSS}$, $T_J \leq 150^\circ\text{C}$ Suggested $R_G = 2.35\Omega$
IRF230	@ $V_{DD} = 50\text{V}$, Starting $T_J = 25^\circ\text{C}$, $L \geq 1.0 \text{mH}$, $R_G = 25\Omega$, Peak $I_L = 9.0\text{A}$	$I_{SD} \leq 9.0\text{A}$, $di/dt \leq 120 \text{A}/\mu\text{s}$, $V_{DD} \leq BV_{DSS}$, $T_J \leq 150^\circ\text{C}$ Suggested $R_G = 7.5\Omega$
IRF240	@ $V_{DD} = 50\text{V}$, Starting $T_J = 25^\circ\text{C}$, $L \geq 2.1 \text{mH}$, $R_G = 25\Omega$, Peak $I_L = 18\text{A}$	$I_{SD} \leq 18\text{A}$, $di/dt \leq 160 \text{A}/\mu\text{s}$, $V_{DD} \leq BV_{DSS}$, $T_J \leq 150^\circ\text{C}$ Suggested $R_G = 9.1\Omega$
IRF250	@ $V_{DD} = 50\text{V}$, Starting $T_J = 25^\circ\text{C}$, $L \geq 330 \mu\text{H}$, $R_G = 25\Omega$, Peak $I_L = 30\text{A}$	$I_{SD} \leq 30\text{A}$, $di/dt \leq 190 \text{A}/\mu\text{s}$, $V_{DD} \leq BV_{DSS}$, $T_J \leq 150^\circ\text{C}$ Suggested $R_G = 2.35\Omega$
IRF330	@ $V_{DD} = 50\text{V}$, Starting $T_J = 25^\circ\text{C}$, $L \geq 100 \mu\text{H}$, $R_G = 25\Omega$, Peak $I_L = 5.5\text{A}$	$I_{SD} \leq 5.5\text{A}$, $di/dt \leq 90 \text{A}/\mu\text{s}$, $V_{DD} \leq BV_{DSS}$, $T_J \leq 150^\circ\text{C}$ Suggested $R_G = 7.5\Omega$
IRF340	@ $V_{DD} = 50\text{V}$, Starting $T_J = 25^\circ\text{C}$, $L \geq 100 \mu\text{H}$, $R_G = 25\Omega$, Peak $I_L = 10\text{A}$	$I_{SD} \leq 10\text{A}$, $di/dt \leq 120 \text{A}/\mu\text{s}$, $V_{DD} \leq BV_{DSS}$, $T_J \leq 150^\circ\text{C}$ Suggested $R_G = 9.1\Omega$
IRF350	@ $V_{DD} = 50\text{V}$, Starting $T_J = 25^\circ\text{C}$, $L \geq 100 \mu\text{H}$, $R_G = 25\Omega$, Peak $I_L = 14\text{A}$	$I_{SD} \leq 14\text{A}$, $di/dt \leq 145 \text{A}/\mu\text{s}$, $V_{DD} \leq BV_{DSS}$, $T_J \leq 150^\circ\text{C}$ Suggested $R_G = 2.35\Omega$
IRF360	@ $V_{DD} = 50\text{V}$, Starting $T_J = 25^\circ\text{C}$, $L \geq 2.8 \text{mH}$, $R_G = 25\Omega$, Peak $I_L = 25\text{A}$	$I_{SD} \leq 25\text{A}$, $di/dt \leq 170 \text{A}/\mu\text{s}$, $V_{DD} \leq BV_{DSS}$, $T_J \leq 150^\circ\text{C}$ Suggested $R_G = 2.35\Omega$

Table 1 — (continued)

Device	Note ②	Note ③
IRF430	@ $V_{DD} = 50V$, Starting $T_J = 25^\circ C$, $L \geq 100 \mu H$, $R_G = 25\Omega$, Peak $I_L = 4.5A$	$I_{SD} \leq 4.5A$, $di/dt \leq 75 A/\mu s$, $V_{DD} \leq BV_{DSS}$, $T_J \leq 150^\circ C$ Suggested $R_G = 7.5\Omega$
IRF440	@ $V_{DD} = 50V$, Starting $T_J = 25^\circ C$, $L \geq 100 \mu H$, $R_G = 25\Omega$, Peak $I_L = 8.0A$	$I_{SD} \leq 8.0A$, $di/dt \leq 100 A/\mu s$, $V_{DD} \leq BV_{DSS}$, $T_J \leq 150^\circ C$ Suggested $R_G = 9.1\Omega$
IRF450	@ $V_{DD} = 50V$, Starting $T_J = 25^\circ C$, $L \geq 100 \mu H$, $R_G = 25\Omega$, Peak $I_L = 12A$	$I_{SD} \leq 12A$, $di/dt \leq 130 A/\mu s$, $V_{DD} \leq BV_{DSS}$, $T_J \leq 150^\circ C$ Suggested $R_G = 2.35\Omega$
IRF460	@ $V_{DD} = 50V$, Starting $T_J = 25^\circ C$, $L \geq 4.9 mH$, $R_G = 25\Omega$, Peak $I_L = 21A$	$I_{SD} \leq 21A$, $di/dt \leq 160 A/\mu s$, $V_{DD} \leq BV_{DSS}$, $T_J \leq 150^\circ C$ Suggested $R_G = 2.35\Omega$
IRFAC30	@ $V_{DD} = 50V$, Starting $T_J = 25^\circ C$, $L \geq 25 mH$, $R_G = 25\Omega$, Peak $I_L = 3.6A$	$I_{SD} \leq 3.6A$, $di/dt \leq 60 A/\mu s$, $V_{DD} \leq BV_{DSS}$, $T_J \leq 150^\circ C$ Suggested $R_G = 7.5\Omega$
IRFAC40	@ $V_{DD} = 50V$, Starting $T_J = 25^\circ C$, $L \geq 27 mH$, $R_G = 25\Omega$, Peak $I_L = 6.2A$	$I_{SD} \leq 6.2A$, $di/dt \leq 80 A/\mu s$, $V_{DD} \leq BV_{DSS}$, $T_J \leq 150^\circ C$ Suggested $R_G = 9.1\Omega$
IRFAE30	@ $V_{DD} = 50V$, Starting $T_J = 25^\circ C$, $L \geq 20 mH$, $R_G = 25\Omega$, Peak $I_L = 3.1A$	$I_{SD} \leq 3.1A$, $di/dt \leq 100 A/\mu s$, $V_{DD} \leq BV_{DSS}$, $T_J \leq 150^\circ C$ Suggested $R_G = 7.5\Omega$
IRFAE40	@ $V_{DD} = 50V$, Starting $T_J = 25^\circ C$, $L \geq 45 mH$, $R_G = 25\Omega$, Peak $I_L = 4.8A$	$I_{SD} \leq 4.8A$, $di/dt \leq 120 A/\mu s$, $V_{DD} \leq BV_{DSS}$, $T_J \leq 150^\circ C$ Suggested $R_G = 9.1\Omega$
IRFAF30	@ $V_{DD} = 50V$, Starting $T_J = 25^\circ C$, $L \geq 47 mH$, $R_G = 25\Omega$, Peak $I_L = 2.0A$	$I_{SD} \leq 2.0A$, $di/dt \leq 90 A/\mu s$, $V_{DD} \leq BV_{DSS}$, $T_J \leq 150^\circ C$ Suggested $R_G = 7.5\Omega$
IRFAF40	@ $V_{DD} = 50V$, Starting $T_J = 25^\circ C$, $L \geq 54 mH$, $R_G = 25\Omega$, Peak $I_L = 4.3A$	$I_{SD} \leq 4.3A$, $di/dt \leq 110 A/\mu s$, $V_{DD} \leq BV_{DSS}$, $T_J \leq 150^\circ C$ Suggested $R_G = 9.1\Omega$
IRFAF50	@ $V_{DD} = 50V$, Starting $T_J = 25^\circ C$, $L \geq 43 mH$, $R_G = 25\Omega$, Peak $I_L = 6.2A$	$I_{SD} \leq 6.2A$, $di/dt \leq 130 A/\mu s$, $V_{DD} \leq BV_{DSS}$, $T_J \leq 150^\circ C$ Suggested $R_G = 2.35\Omega$
IRFAG30	@ $V_{DD} = 50V$, Starting $T_J = 25^\circ C$, $L \geq 40 mH$, $R_G = 25\Omega$, Peak $I_L = 2.3A$	$I_{SD} \leq 2.3A$, $di/dt \leq 80 A/\mu s$, $V_{DD} \leq BV_{DSS}$, $T_J \leq 150^\circ C$ Suggested $R_G = 7.5\Omega$

Table 1 — (continued)

Device	Note ②	Note ③
IRFAG40	@ $V_{DD} = 50V$, Starting $T_J = 25^\circ C$, $L \geq 66 \text{ mH}$, $R_G = 25\Omega$, Peak $I_L = 3.9A$	$I_{SD} \leq 3.9A$, $di/dt \leq 100 A/\mu s$, $V_{DD} \leq BV_{DSS}$, $T_J \leq 150^\circ C$ Suggested $R_G = 9.1\Omega$
IRFAG50	@ $V_{DD} = 50V$, Starting $T_J = 25^\circ C$, $L \geq 52 \text{ mH}$, $R_G = 25\Omega$, Peak $I_L = 5.6A$	$I_{SD} \leq 5.6A$, $di/dt \leq 120 A/\mu s$, $V_{DD} \leq BV_{DSS}$, $T_J \leq 150^\circ C$ Suggested $R_G = 2.35\Omega$
IRF9130	@ $V_{DD} = -25V$, Starting $T_J = 25^\circ C$, $L \geq 1.0 \text{ mH}$, $R_G = 25\Omega$, Peak $I_L = -11A$	$I_{SD} \leq -11A$, $di/dt \leq -140 A/\mu s$, $V_{DD} \leq BV_{DSS}$, $T_J \leq 150^\circ C$ Suggested $R_G = 7.5\Omega$
IRF9140	@ $V_{DD} = -25V$, Starting $T_J = 25^\circ C$, $L \geq 2.3 \text{ mH}$, $R_G = 25\Omega$, Peak $I_L = -18A$	$I_{SD} \leq -18A$, $di/dt \leq -100 A/\mu s$, $V_{DD} \leq BV_{DSS}$, $T_J \leq 150^\circ C$ Suggested $R_G = 9.1\Omega$
IRF9230	@ $V_{DD} = -50V$, Starting $T_J = 25^\circ C$, $L \geq 2.3 \text{ mH}$, $R_G = 25\Omega$, Peak $I_L = -6.5A$	$I_{SD} \leq -6.5A$, $di/dt \leq -120 A/\mu s$, $V_{DD} \leq BV_{DSS}$, $T_J \leq 150^\circ C$ Suggested $R_G = 7.5\Omega$
IRF9240	@ $V_{DD} = -50V$, Starting $T_J = 25^\circ C$, $L \geq 6.2 \text{ mH}$, $R_G = 25\Omega$, Peak $I_L = -11A$	$I_{SD} \leq -11A$, $di/dt \leq -150 A/\mu s$, $V_{DD} \leq BV_{DSS}$, $T_J \leq 150^\circ C$ Suggested $R_G = 9.1\Omega$

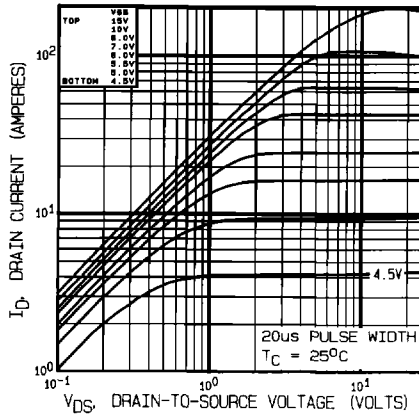

Fig. 1a - Typical Output Characteristics, $T_C = 25^\circ\text{C}$
IRF034

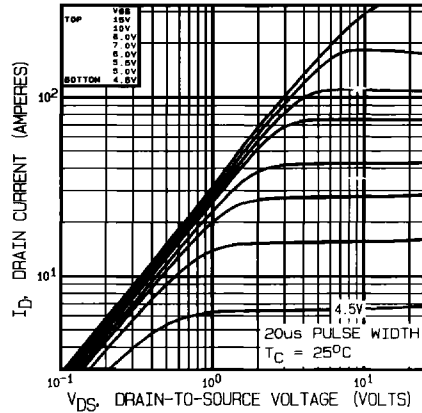

Fig. 1b - Typical Output Characteristics, $T_C = 25^\circ\text{C}$
IRF044

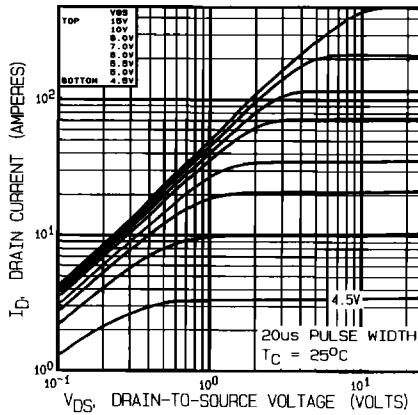

Fig. 1c - Typical Output Characteristics, $T_C = 25^\circ\text{C}$
IRF54

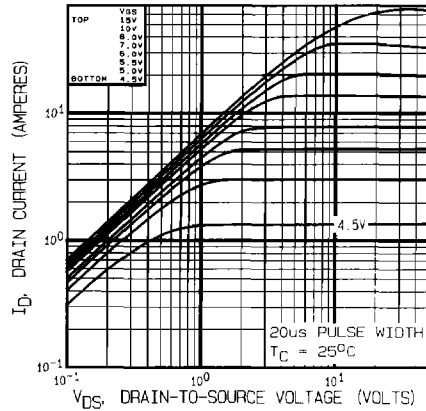

Fig. 1d - Typical Output Characteristics, $T_C = 25^\circ\text{C}$
IRF130

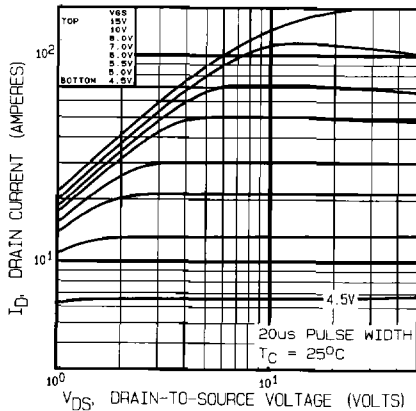

Fig. 1e - Typical Output Characteristics, $T_C = 25^\circ\text{C}$
IRF140

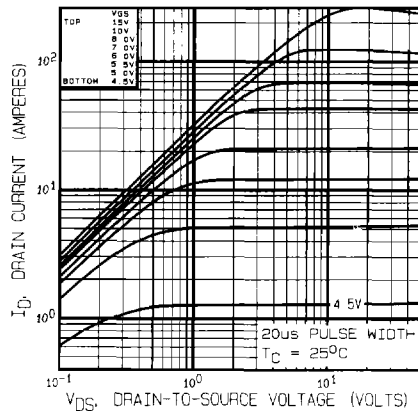

Fig. 1f - Typical Output Characteristics, $T_C = 25^\circ\text{C}$
IRF150

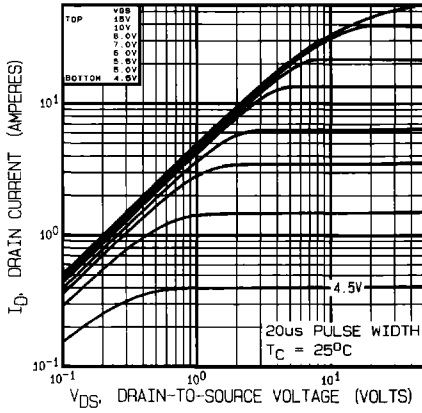

Fig. 1g - Typical Output Characteristics, $T_C = 25^\circ\text{C}$
IRF230

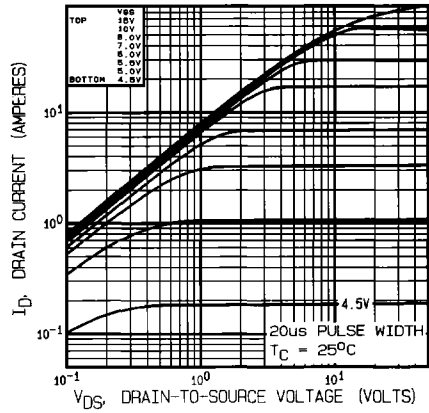

Fig. 1h - Typical Output Characteristics, $T_C = 25^\circ\text{C}$
IRF240

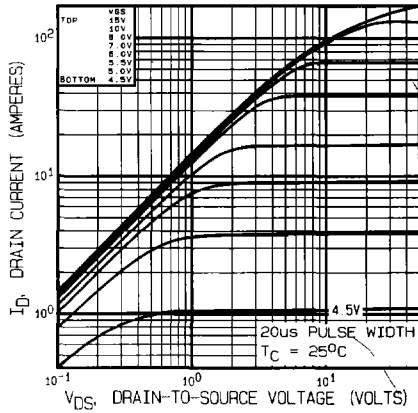

Fig. 1i - Typical Output Characteristics, $T_C = 25^\circ\text{C}$
IRF250

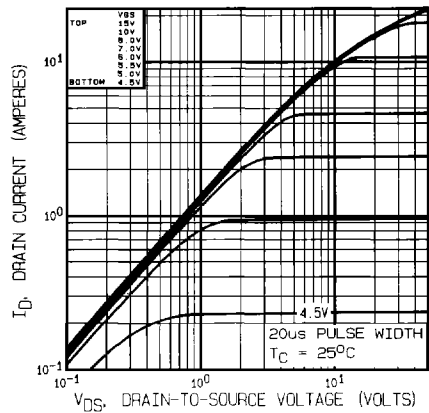

Fig. 1j - Typical Output Characteristics, $T_C = 25^\circ\text{C}$
IRF330

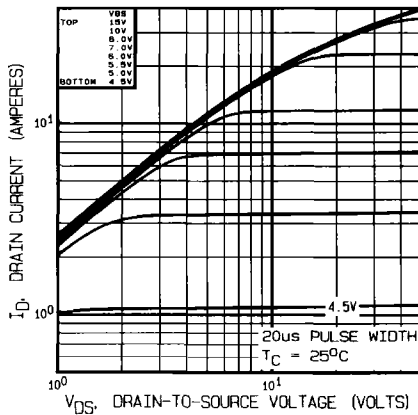

Fig. 1k - Typical Output Characteristics, $T_C = 25^\circ\text{C}$
IRF340

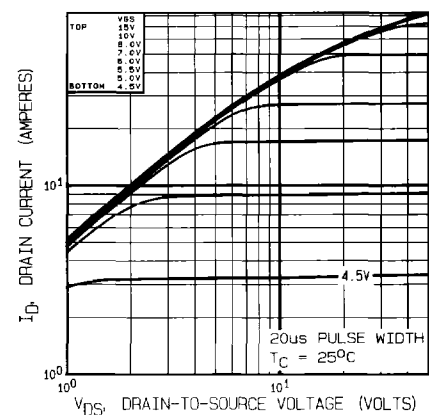
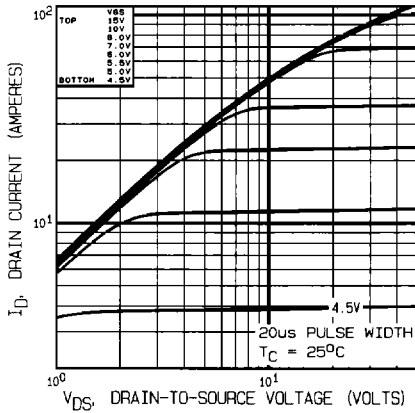
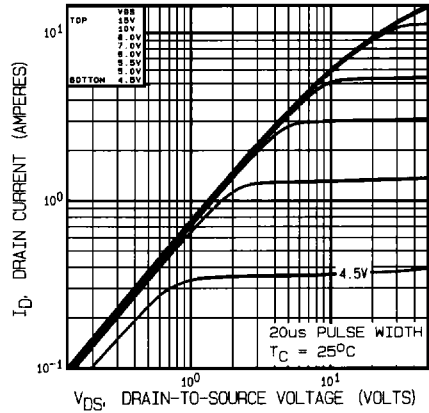

Fig. 1l - Typical Output Characteristics, $T_C = 25^\circ\text{C}$
IRF350



**Fig. 1m - Typical Output Characteristics, $T_C = 25^\circ\text{C}$
IRF360**



**Fig. 1n - Typical Output Characteristics, $T_C = 25^\circ\text{C}$
IRF430**

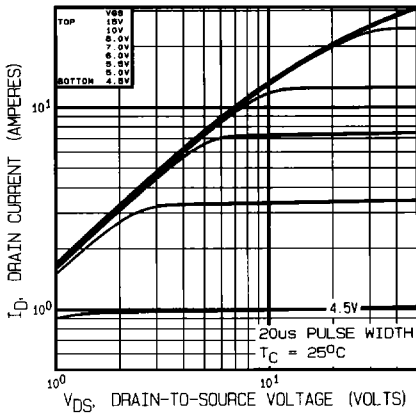

**Fig. 1o - Typical Output Characteristics, $T_C = 25^\circ\text{C}$
IRF440**

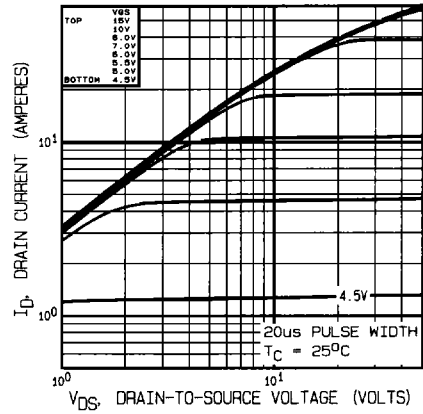

**Fig. 1p - Typical Output Characteristics, $T_C = 25^\circ\text{C}$
IRF450**

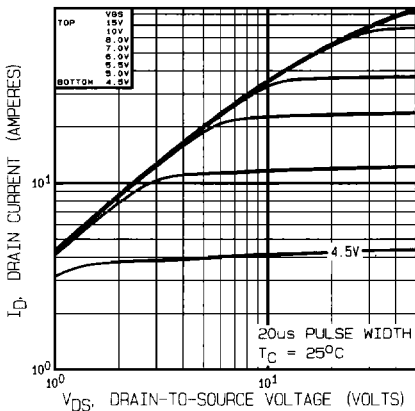

**Fig. 1q - Typical Output Characteristics, $T_C = 25^\circ\text{C}$
IRF460**

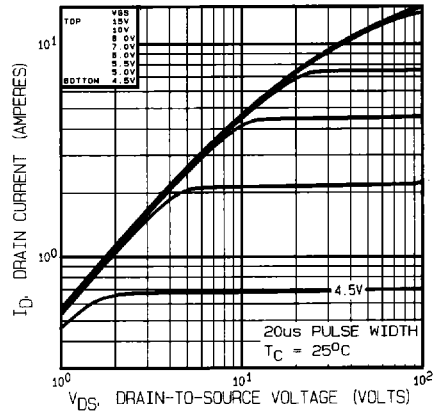

**Fig. 1r - Typical Output Characteristics, $T_C = 25^\circ\text{C}$
IRFAC30**

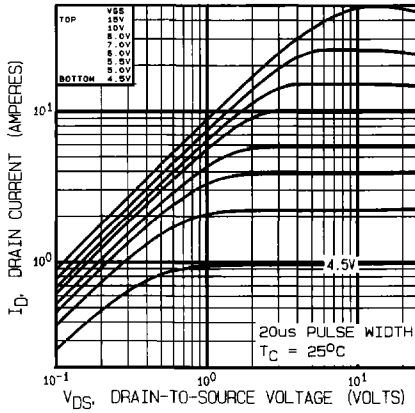

Fig. 1a - Typical Output Characteristics, $T_C = 25^\circ\text{C}$
IRFAC40

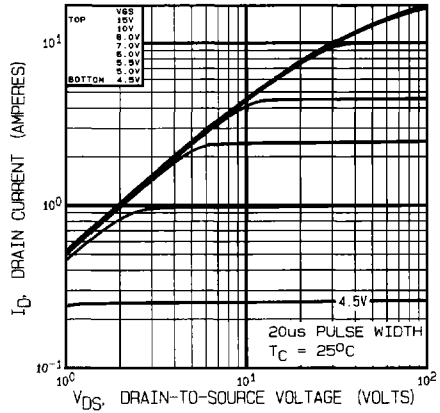

Fig. 1t - Typical Output Characteristics, $T_C = 25^\circ\text{C}$
IRFAE30

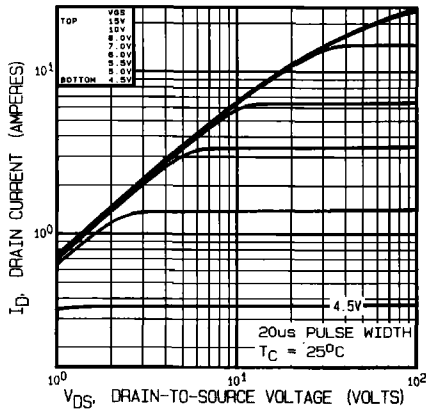

Fig. 1u - Typical Output Characteristics, $T_C = 25^\circ\text{C}$
IRFAE40

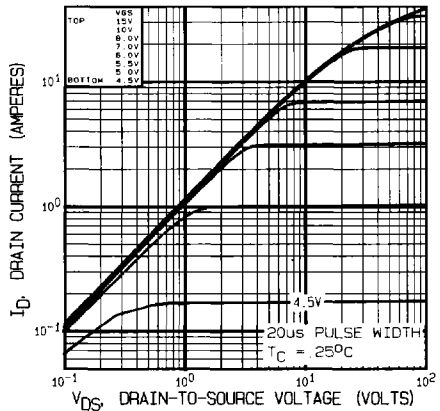

Fig. 1v - Typical Output Characteristics, $T_C = 25^\circ\text{C}$
IRFAE50

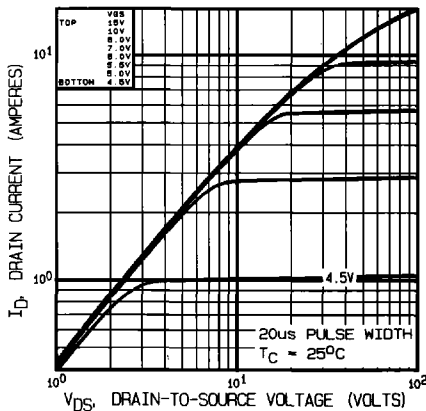

Fig. 1w - Typical Output Characteristics, $T_C = 25^\circ\text{C}$
IRFAF30

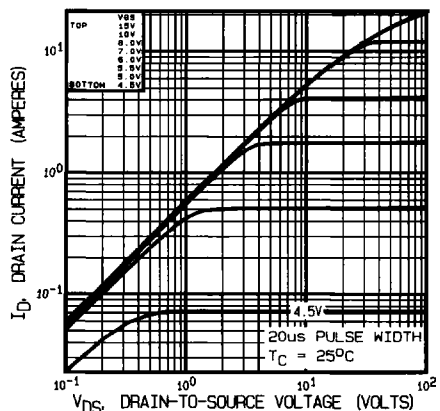

Fig. 1x - Typical Output Characteristics, $T_C = 25^\circ\text{C}$
IRFAF40

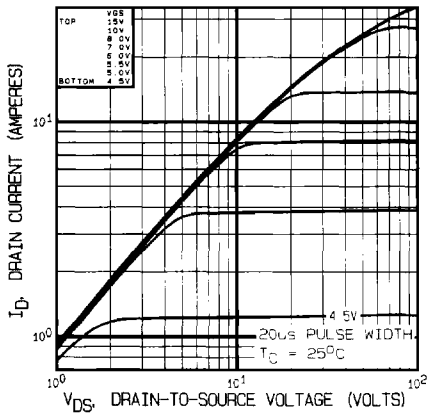

Fig. 1y - Typical Output Characteristics, $T_C = 25^\circ\text{C}$
IRFAF50

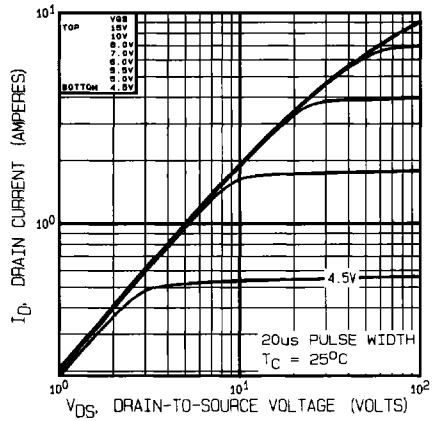

Fig. 1z - Typical Output Characteristics, $T_C = 25^\circ\text{C}$
IRFAG30

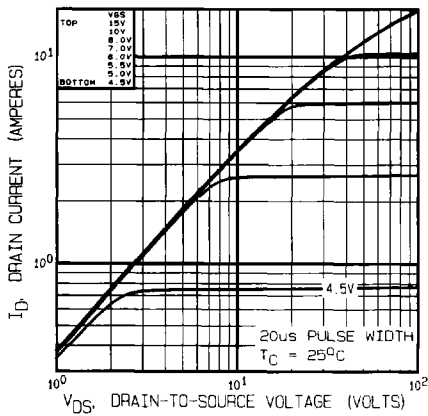

Fig. 1aa - Typical Output Characteristics, $T_C = 25^\circ\text{C}$
IRFAG40

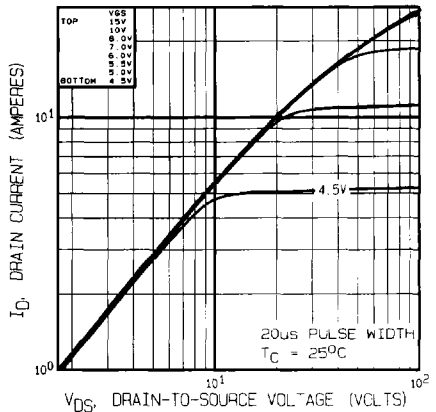

Fig. 1bb - Typical Output Characteristics, $T_C = 25^\circ\text{C}$
IRFAG50

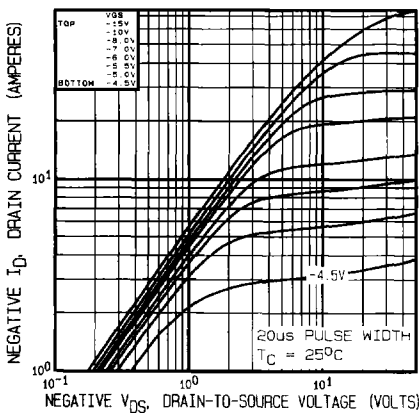

Fig. 1cc - Typical Output Characteristics, $T_C = 25^\circ\text{C}$
IRF9130

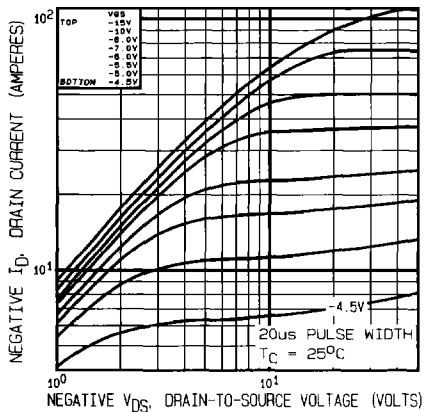

Fig. 1dd - Typical Output Characteristics, $T_C = 25^\circ\text{C}$
IRF9140

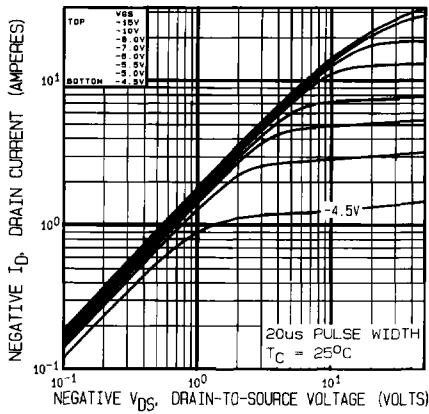

Fig. 1ee - Typical Output Characteristics, $T_C = 25^\circ\text{C}$
IRF9230

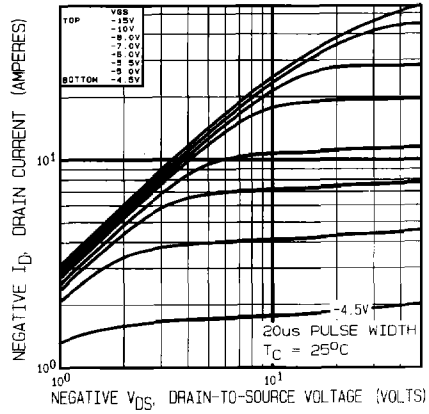

Fig. 1ff - Typical Output Characteristics, $T_C = 25^\circ\text{C}$
IRF9240

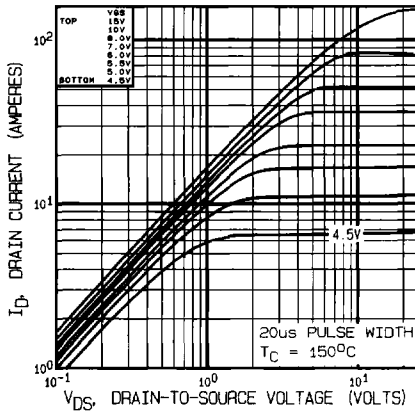

Fig. 2a - Typical Output Characteristics, $T_C = 150^\circ\text{C}$
IRF034

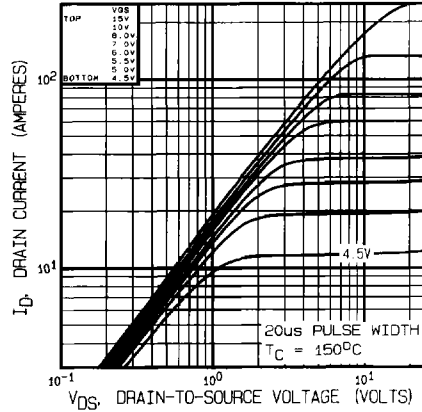

Fig. 2b - Typical Output Characteristics, $T_C = 150^\circ\text{C}$
IRF044

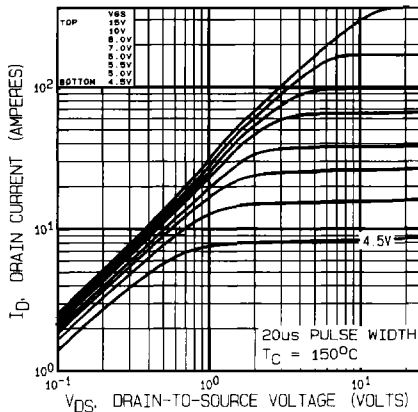

Fig. 2c - Typical Output Characteristics, $T_C = 150^\circ\text{C}$
IRF054

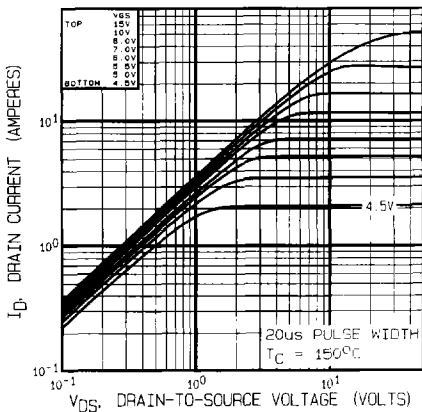

Fig. 2d - Typical Output Characteristics, $T_C = 150^\circ\text{C}$
IRF130

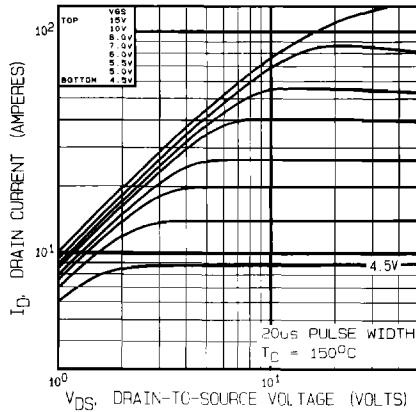

Fig. 2e - Typical Output Characteristics, $T_C = 150^\circ\text{C}$
IRF140

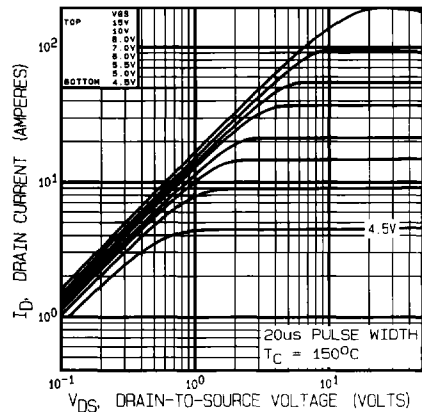

Fig. 2f - Typical Output Characteristics, $T_C = 150^\circ\text{C}$
IRF150

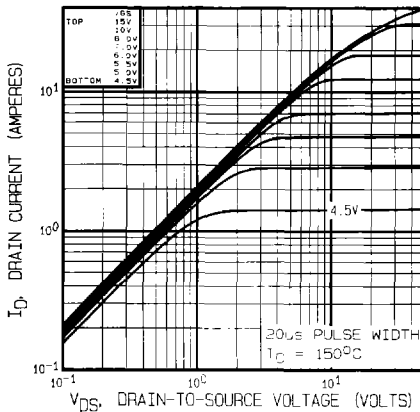

Fig. 2g - Typical Output Characteristics, $T_C = 150^\circ\text{C}$
IRF230

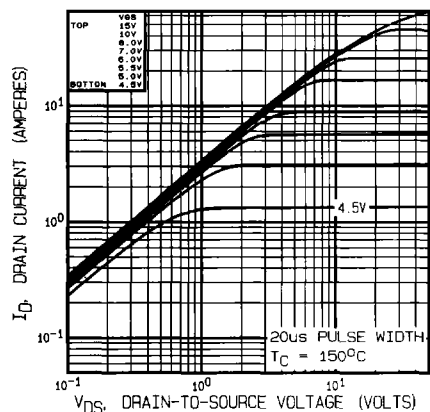

Fig. 2h - Typical Output Characteristics, $T_C = 150^\circ\text{C}$
IRF240

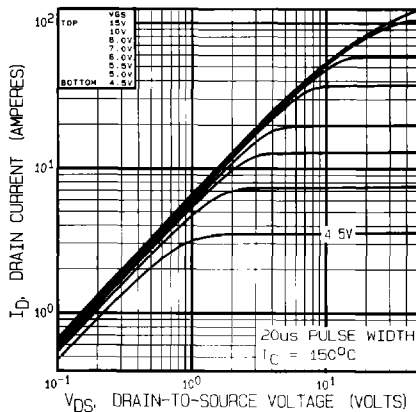

Fig. 2i - Typical Output Characteristics, $T_C = 150^\circ\text{C}$
IRF250

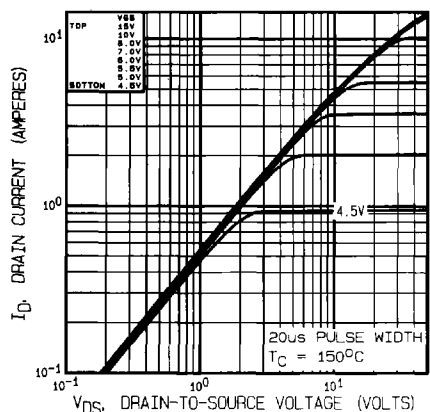

Fig. 2j - Typical Output Characteristics, $T_C = 150^\circ\text{C}$
IRF330

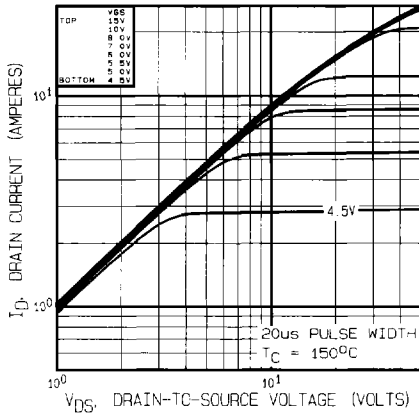

Fig. 2k - Typical Output Characteristics, $T_C = 150^\circ\text{C}$
IRF340

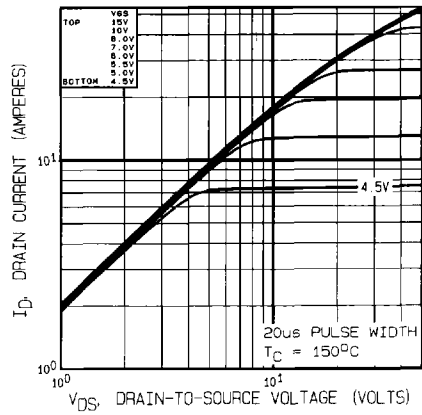

Fig. 2l - Typical Output Characteristics, $T_C = 150^\circ\text{C}$
IRF350

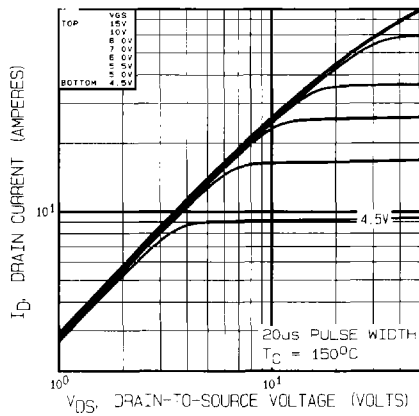

Fig. 2m - Typical Output Characteristics, $T_C = 150^\circ\text{C}$
IRF360

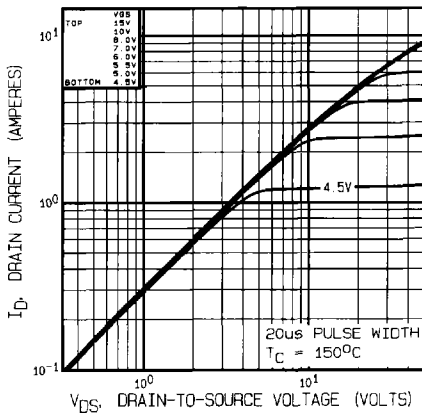

Fig. 2n - Typical Output Characteristics, $T_C = 150^\circ\text{C}$
IRF430

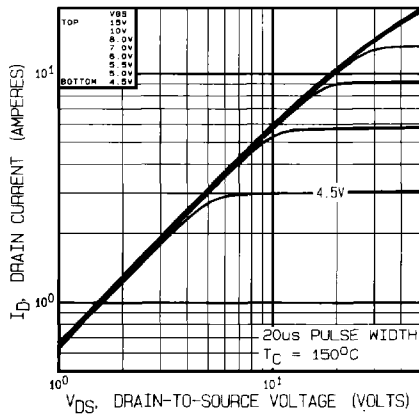

Fig. 2o - Typical Output Characteristics, $T_C = 150^\circ\text{C}$
IRF440

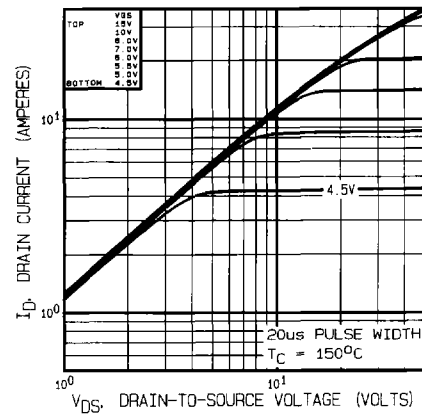

Fig. 2p - Typical Output Characteristics, $T_C = 150^\circ\text{C}$
IRF450

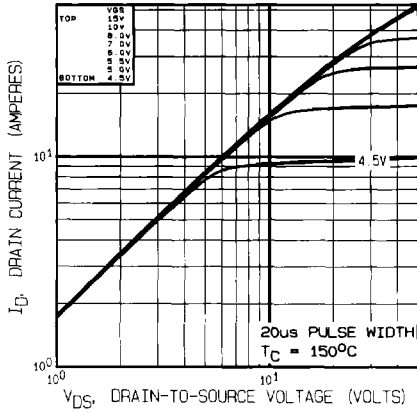

Fig. 2q - Typical Output Characteristics, $T_C = 150^\circ\text{C}$
IRF460

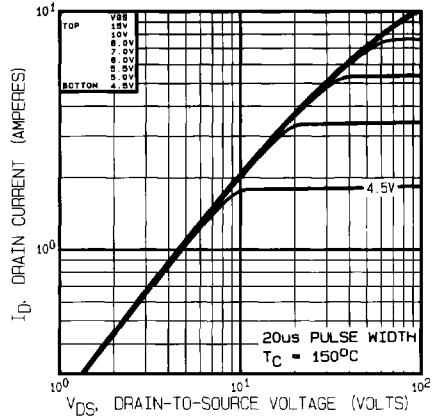

Fig. 2r - Typical Output Characteristics, $T_C = 150^\circ\text{C}$
IRFAC30

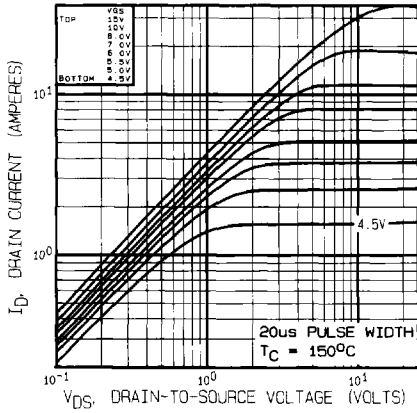

Fig. 2s - Typical Output Characteristics, $T_C = 150^\circ\text{C}$
IRFAC40

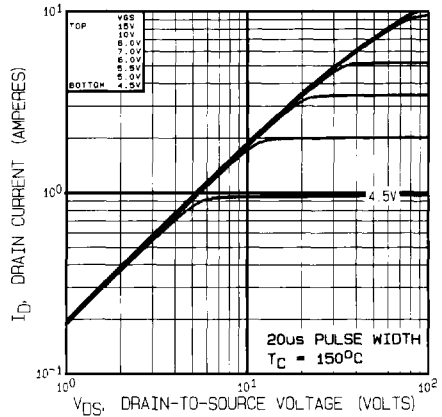

Fig. 2t - Typical Output Characteristics, $T_C = 150^\circ\text{C}$
IRFAE30

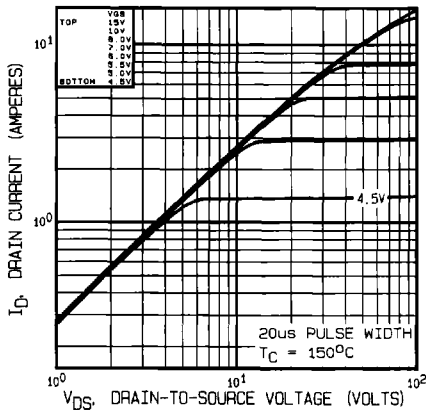

Fig. 2u - Typical Output Characteristics, $T_C = 150^\circ\text{C}$
IRFAE40

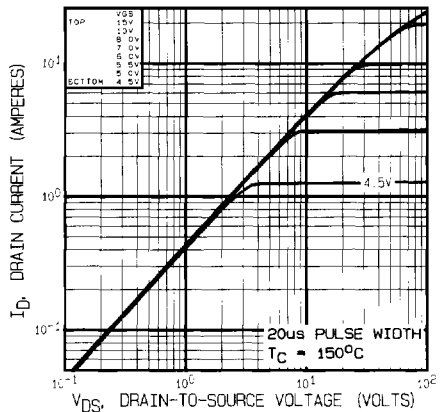

Fig. 2v - Typical Output Characteristics, $T_C = 150^\circ\text{C}$
IRFAE50

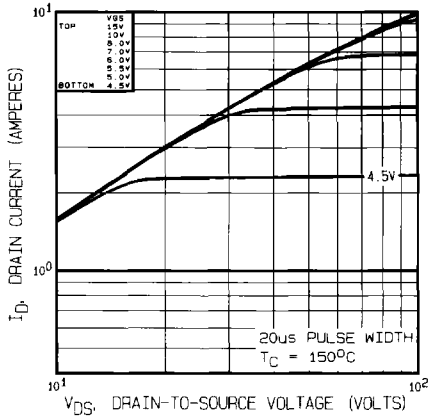

Fig. 2w - Typical Output Characteristics, $T_C = 150^\circ\text{C}$
IRFAF30

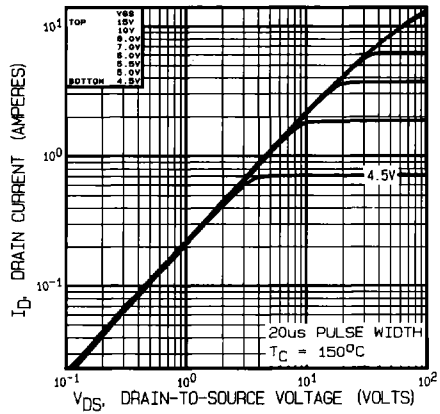

Fig. 2x - Typical Output Characteristics, $T_C = 150^\circ\text{C}$
IRFAF40

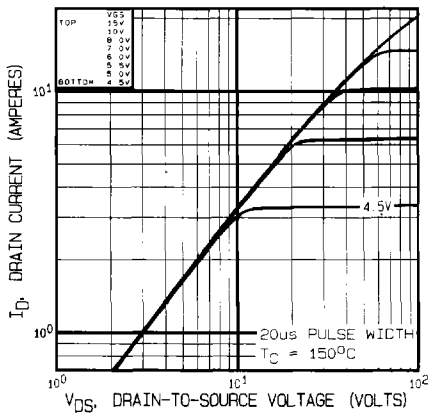

Fig. 2y - Typical Output Characteristics, $T_C = 150^\circ\text{C}$
IRFAF50

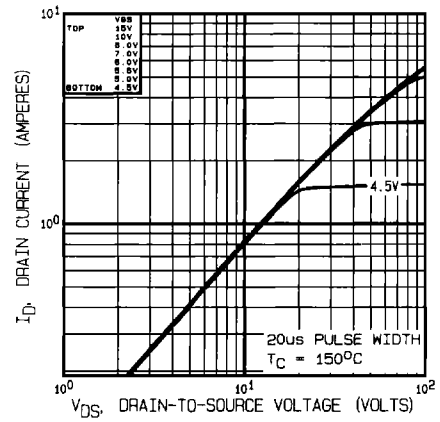

Fig. 2z - Typical Output Characteristics, $T_C = 150^\circ\text{C}$
IRFAG30

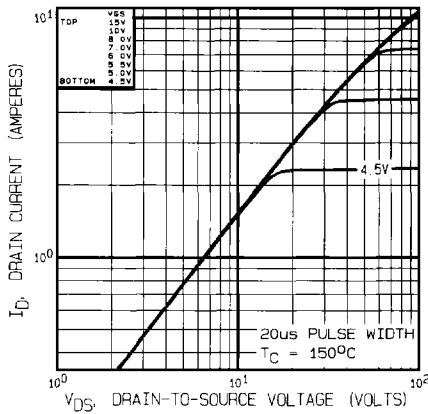

Fig. 2aa - Typical Output Characteristics, $T_C = 150^\circ\text{C}$
IRFAG40

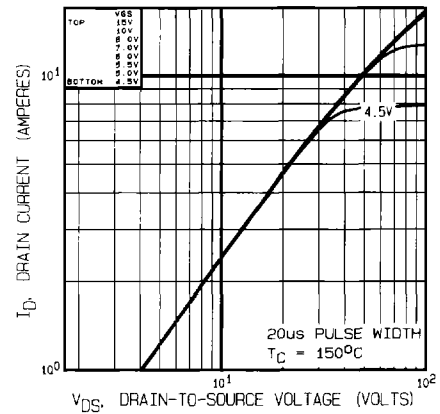

Fig. 2bb - Typical Output Characteristics, $T_C = 150^\circ\text{C}$
IRFAG50

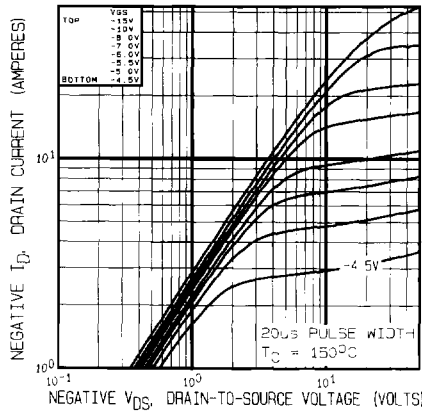

Fig. 2cc – Typical Output Characteristics, $T_C = 150^\circ\text{C}$
IRF9130

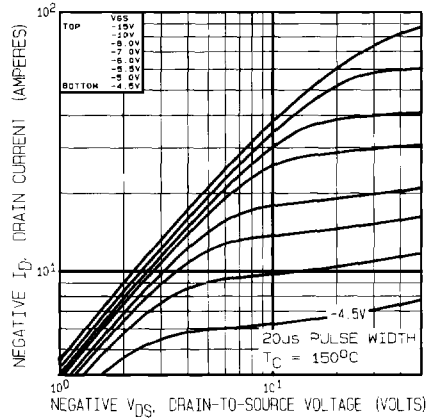

Fig. 2dd – Typical Output Characteristics, $T_C = 150^\circ\text{C}$
IRF9140

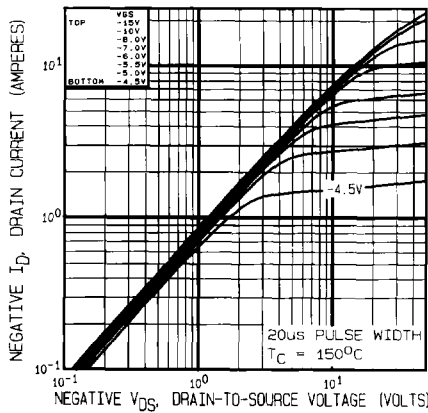

Fig. 2ee – Typical Output Characteristics, $T_C = 150^\circ\text{C}$
IRF9230

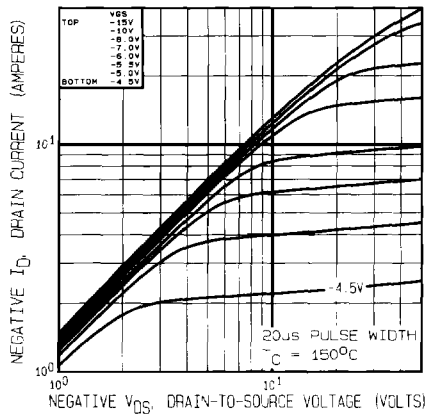

Fig. 2ff – Typical Output Characteristics, $T_C = 150^\circ\text{C}$
IRF9240

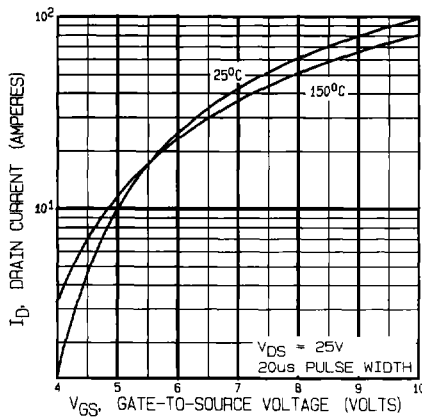

Fig. 3a – Typical Transfer Characteristics
IRF034

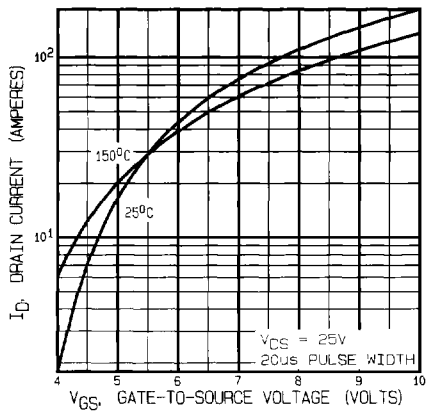

Fig. 3b – Typical Transfer Characteristics
IRF044

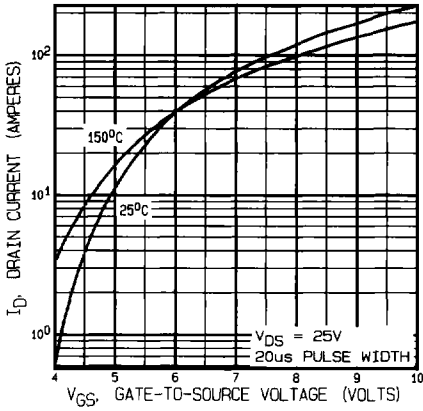

Fig. 3c - Typical Transfer Characteristics IRF054

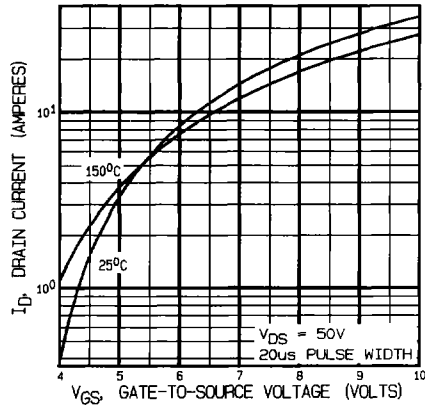

Fig. 3d - Typical Transfer Characteristics IRF130

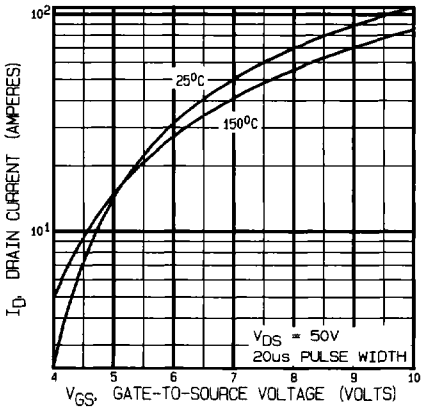

Fig. 3e - Typical Transfer Characteristics IRF140

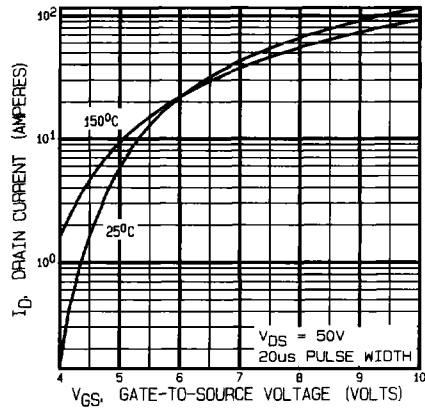

Fig. 3f - Typical Transfer Characteristics IRF150

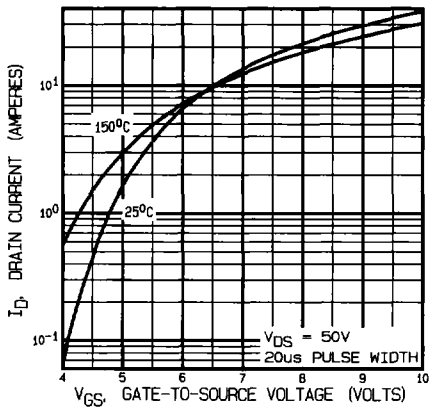

Fig. 3g - Typical Transfer Characteristics IRF230

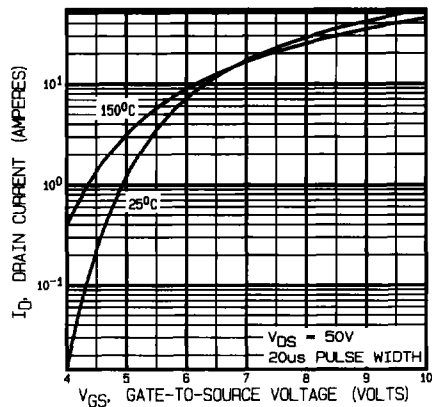
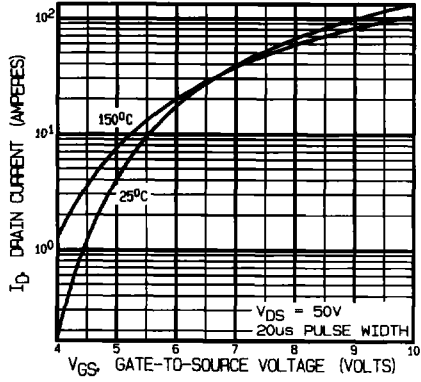
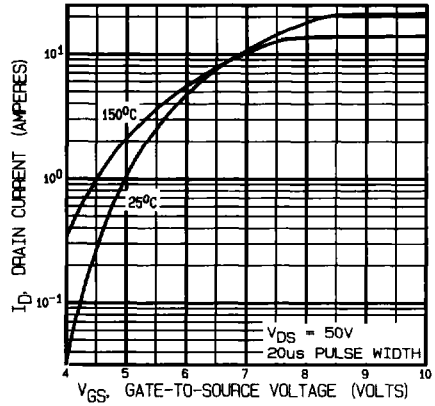

Fig. 3h - Typical Transfer Characteristics IRF240



**Fig. 3i - Typical Transfer Characteristics
IRF250**



**Fig. 3j - Typical Transfer Characteristics
IRF330**

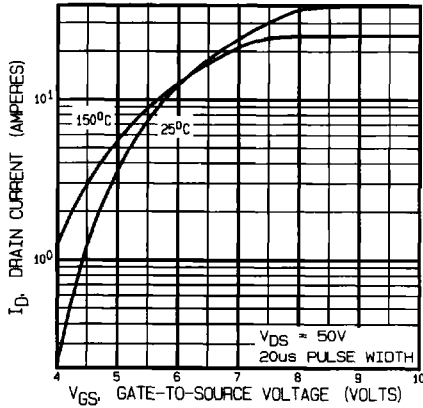

**Fig. 3k - Typical Transfer Characteristics
IRF340**

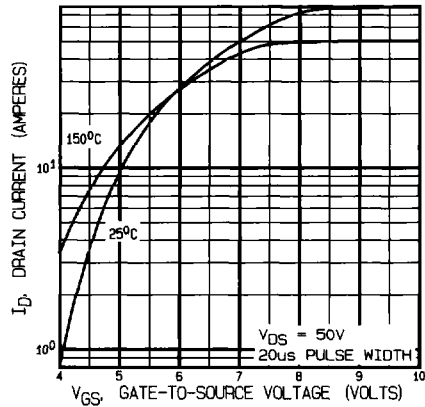

**Fig. 3l - Typical Transfer Characteristics
IRF350**

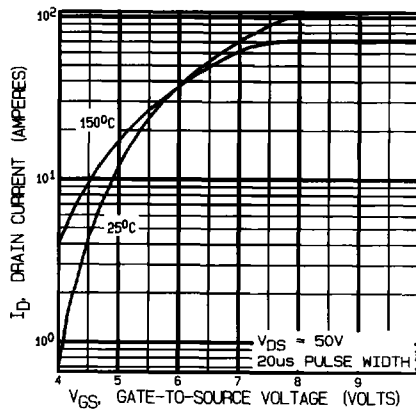

**Fig. 3m - Typical Transfer Characteristics
IRF360**

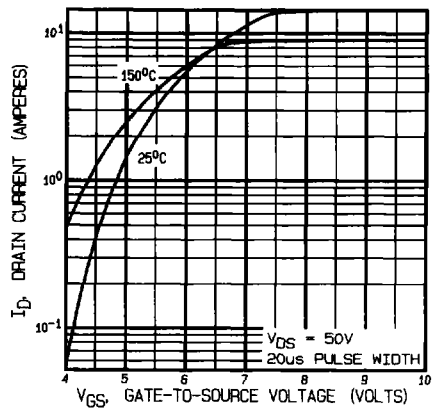

**Fig. 3n - Typical Transfer Characteristics
IRF430**

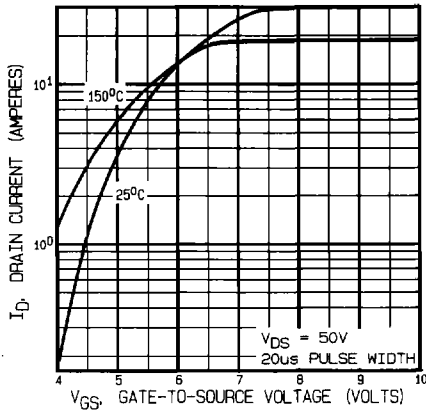

Fig. 3o - Typical Transfer Characteristics
IRF440

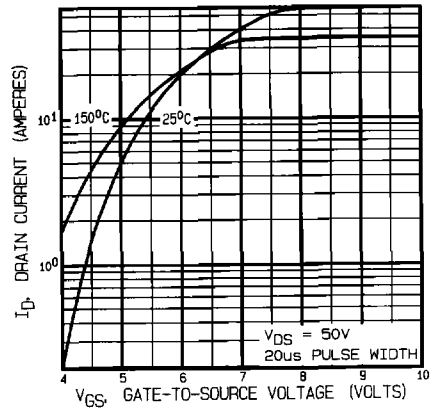

Fig. 3p - Typical Transfer Characteristics
IRF450

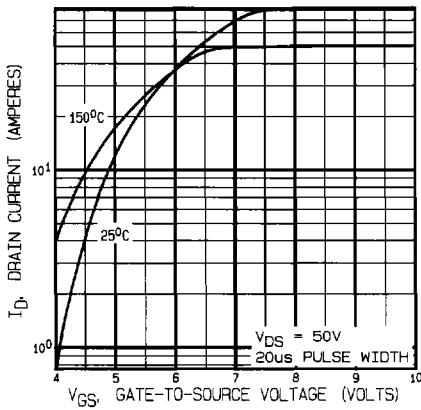

Fig. 3q - Typical Transfer Characteristics
IRF460

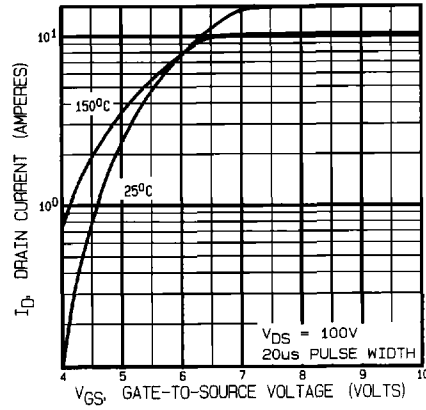

Fig. 3r - Typical Transfer Characteristics
IRFAC30

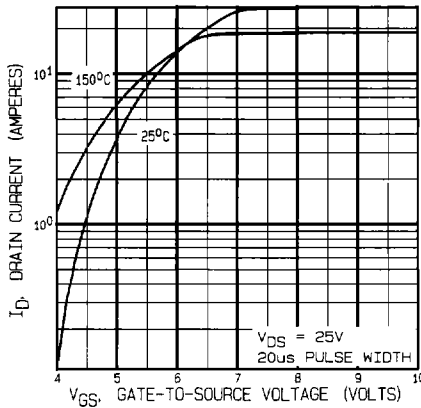

Fig. 3s - Typical Transfer Characteristics
IRFAC40

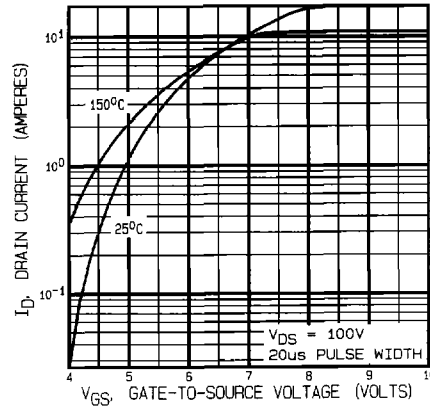

Fig. 3t - Typical Transfer Characteristics
IRFAE30

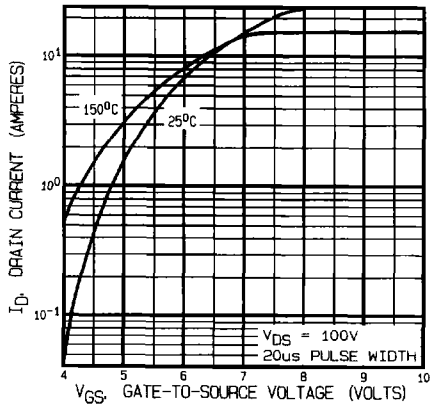

Fig. 3u - Typical Transfer Characteristics IRFAE40

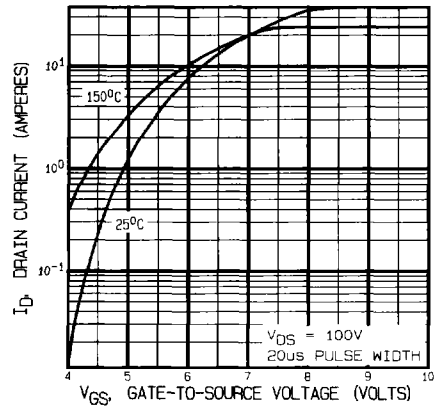

Fig. 3v - Typical Transfer Characteristics IRFAE50

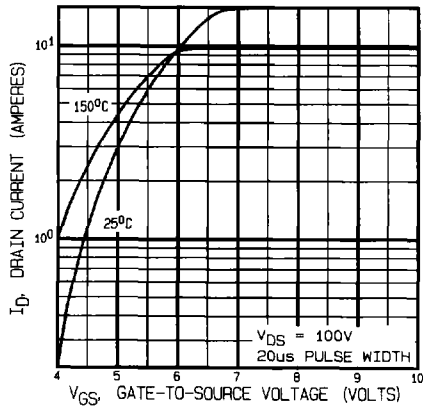

Fig. 3w - Typical Transfer Characteristics IRFAF30

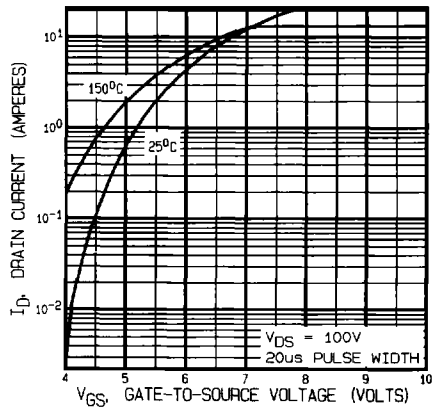

Fig. 3x - Typical Transfer Characteristics IRFAF40

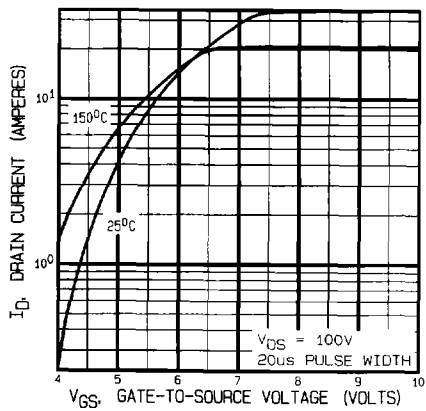

Fig. 3y - Typical Transfer Characteristics IRFAF50

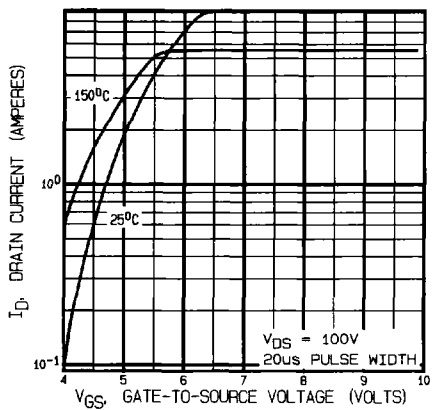

Fig. 3z - Typical Transfer Characteristics IRFAG30

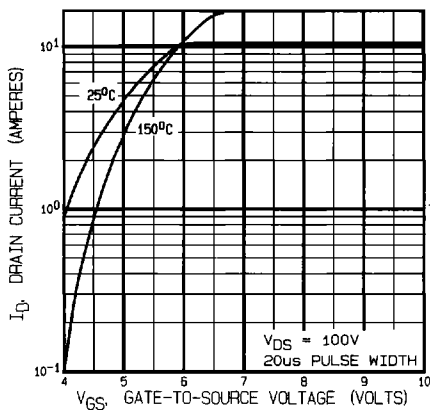

Fig. 3aa - Typical Transfer Characteristics IRFAG40

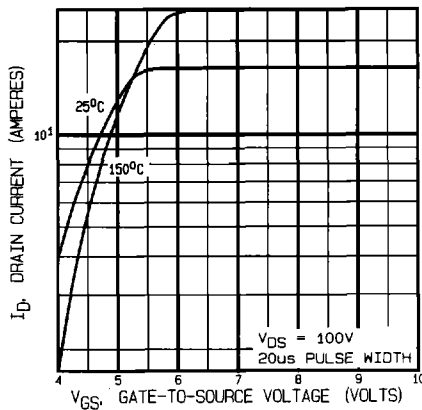

Fig. 3bb - Typical Transfer Characteristics IRFAG50

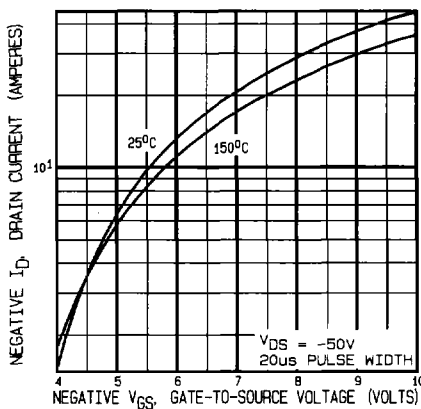

Fig. 3cc - Typical Transfer Characteristics IRF9130

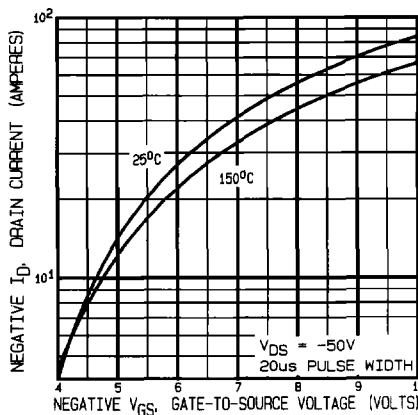

Fig. 3dd - Typical Transfer Characteristics IRF9140

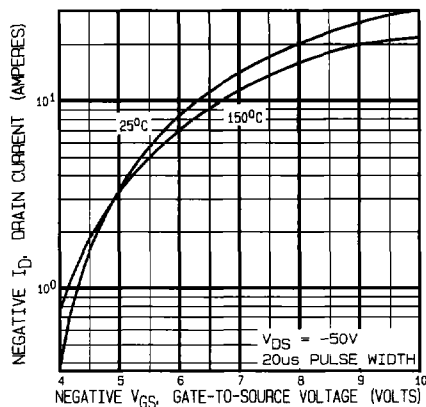

Fig. 3ee - Typical Transfer Characteristics IRF9230

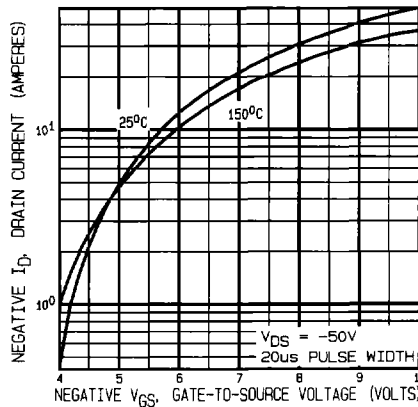

Fig. 3ff - Typical Transfer Characteristics IRF9240

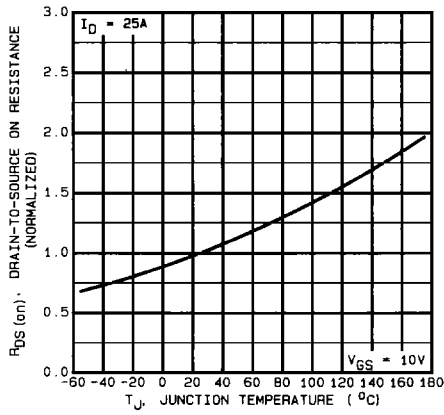

Fig. 4a – Normalized On-Resistance Vs. Temperature
IRF034

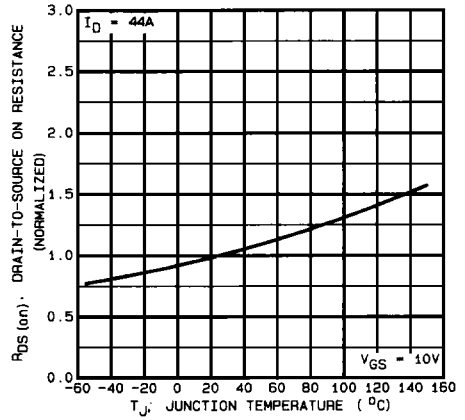

Fig. 4b – Normalized On-Resistance Vs. Temperature
IRF044

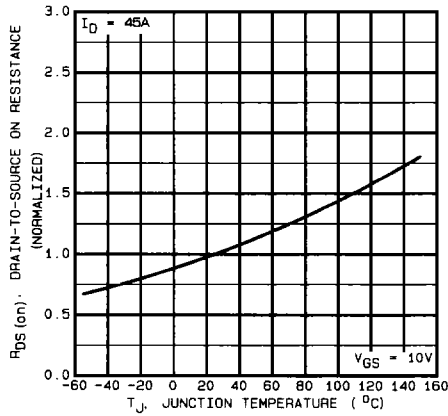

Fig. 4c – Normalized On-Resistance Vs. Temperature
IRF054

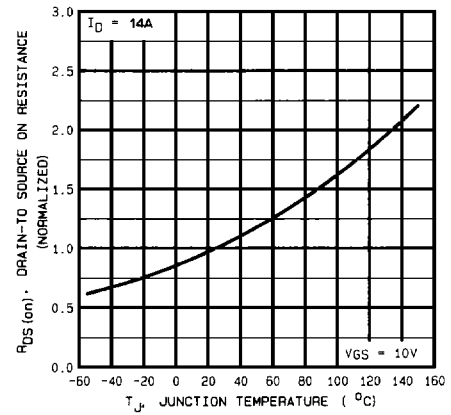

Fig. 4d – Normalized On-Resistance Vs. Temperature
IRF130

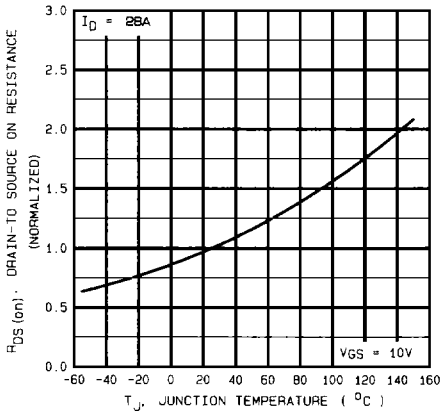

Fig. 4e – Normalized On-Resistance Vs. Temperature
IRF140

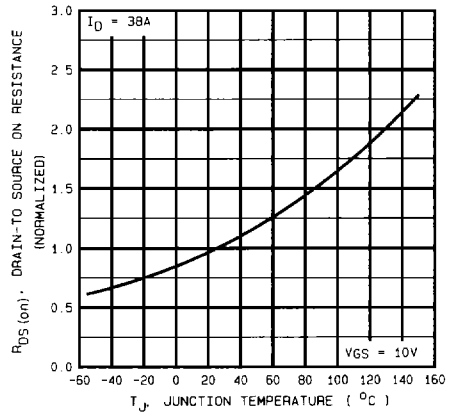

Fig. 4f – Normalized On-Resistance Vs. Temperature
IRF150

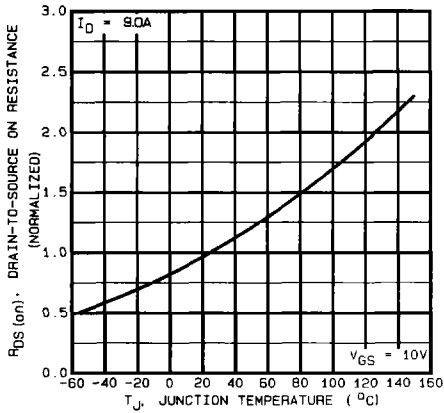

Fig. 4g - Normalized On-Resistance Vs. Temperature IRF230

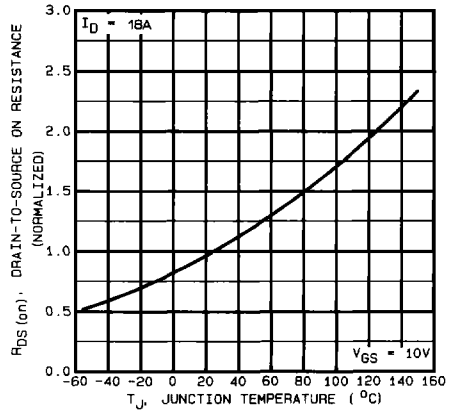

Fig. 4h - Normalized On-Resistance Vs. Temperature IRF240

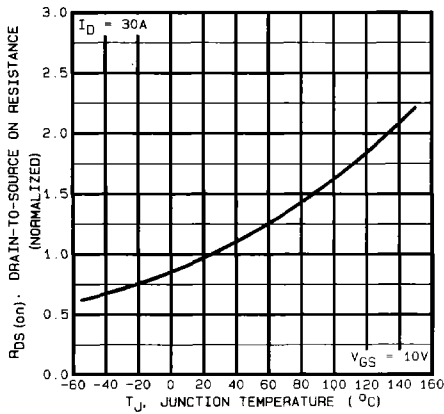

Fig. 4i - Normalized On-Resistance Vs. Temperature IRF250

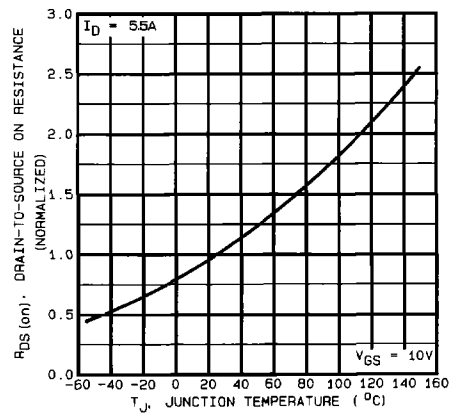

Fig. 4j - Normalized On-Resistance Vs. Temperature IRF330

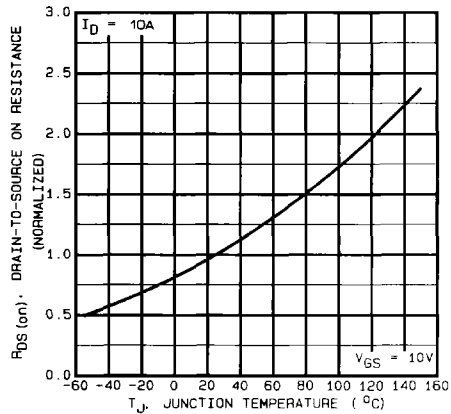

Fig. 4k - Normalized On-Resistance Vs. Temperature IRF340

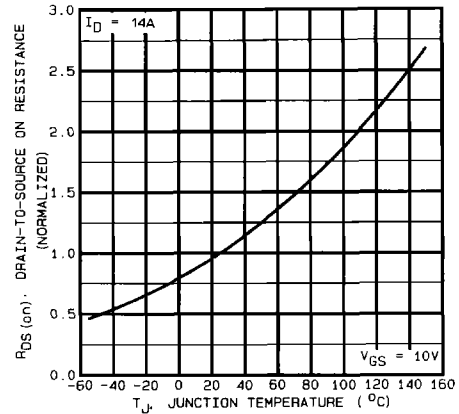

Fig. 4l - Normalized On-Resistance Vs. Temperature IRF350

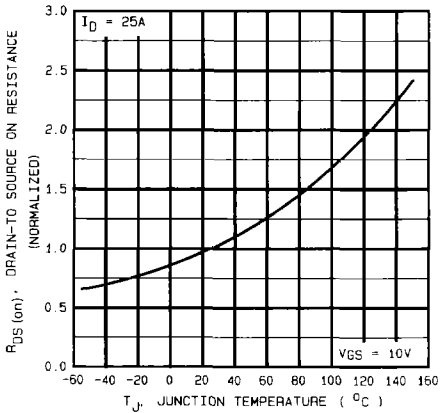

Fig. 4m – Normalized On-Resistance Vs. Temperature
IRF360

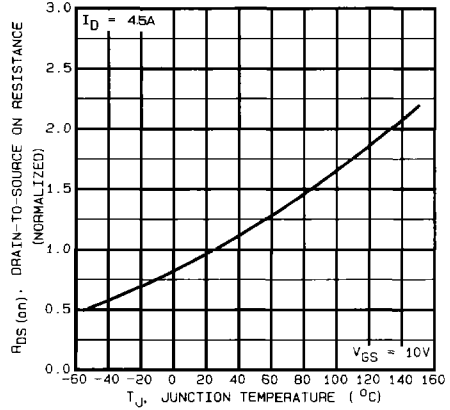

Fig. 4n – Normalized On-Resistance Vs. Temperature
IRF430

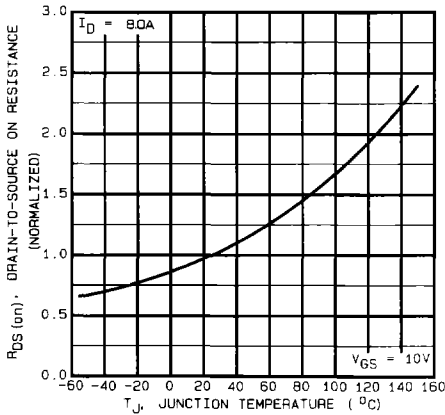

Fig. 4o – Normalized On-Resistance Vs. Temperature
IRF440

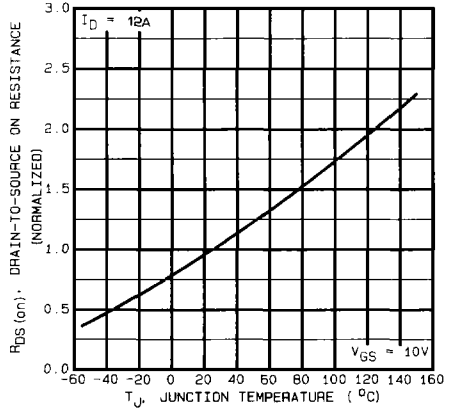

Fig. 4p – Normalized On-Resistance Vs. Temperature
IRF450

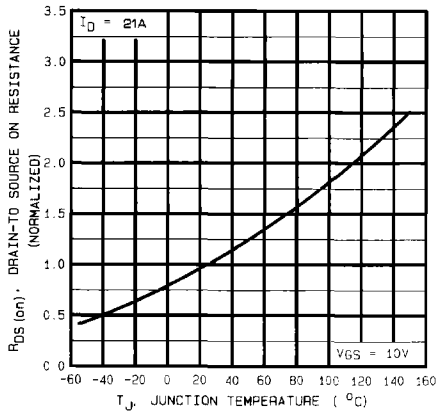

Fig. 4q – Normalized On-Resistance Vs. Temperature
IRF460

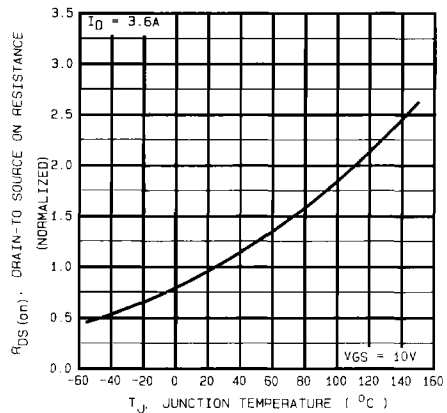

Fig. 4r – Normalized On-Resistance Vs. Temperature
IRFAC30

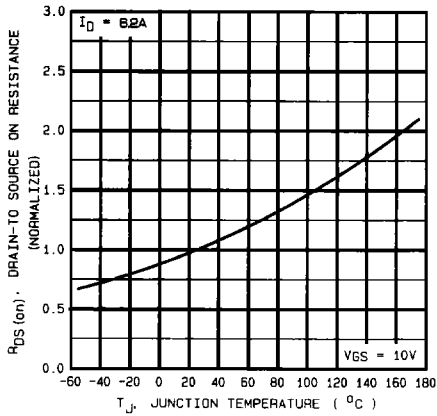

Fig. 4s – Normalized On-Resistance Vs. Temperature IRFAC40

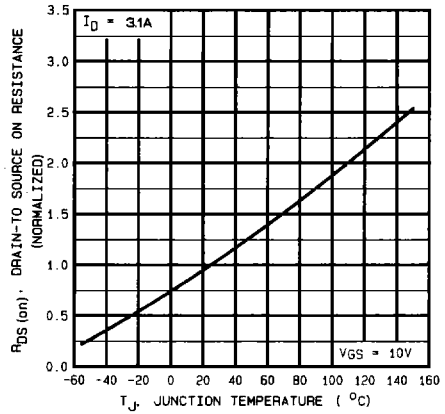

Fig. 4t – Normalized On-Resistance Vs. Temperature IRFAE30

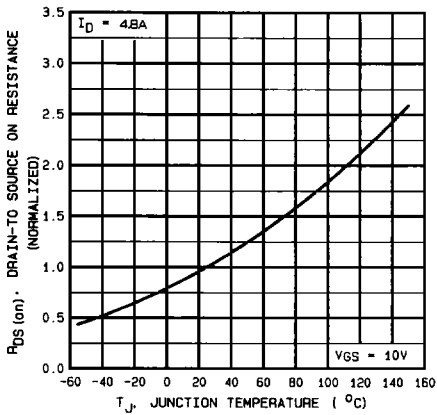

Fig. 4u – Normalized On-Resistance Vs. Temperature IRFAE40

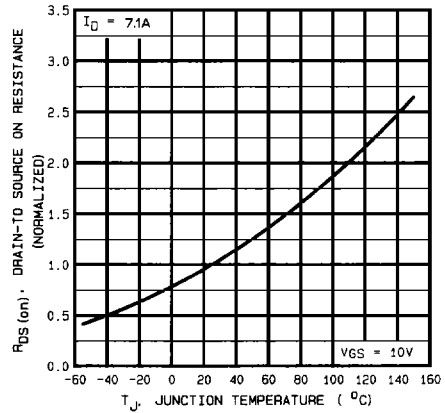

Fig. 4v – Normalized On-Resistance Vs. Temperature IRFAE50

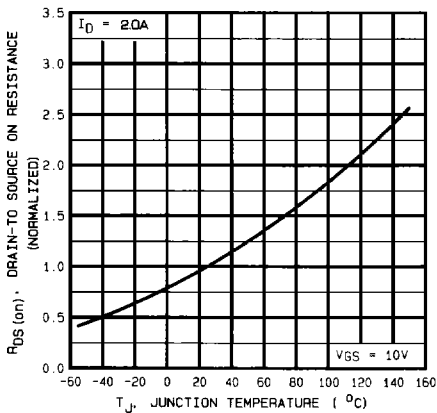

Fig. 4w – Normalized On-Resistance Vs. Temperature IRFAF30

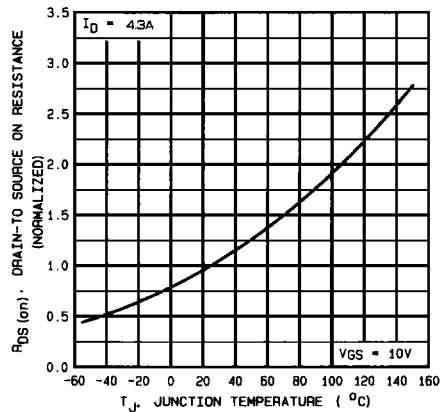

Fig. 4x – Normalized On-Resistance Vs. Temperature IRFAF40

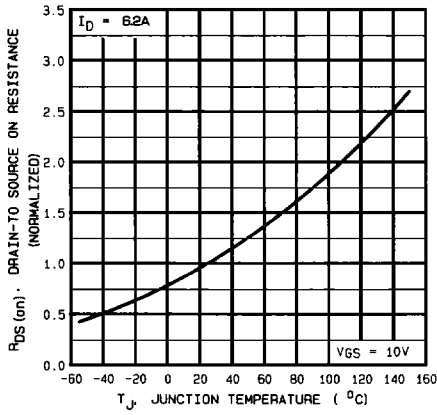

Fig. 4y – Normalized On-Resistance Vs. Temperature IRFAF50

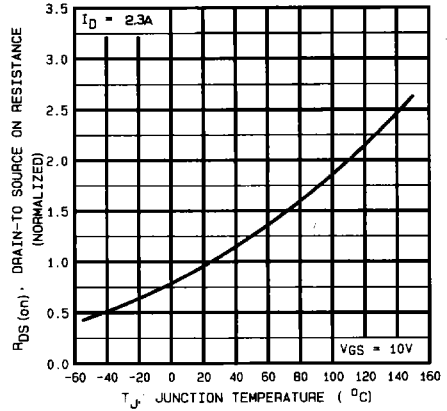

Fig. 4z – Normalized On-Resistance Vs. Temperature IRFAG30

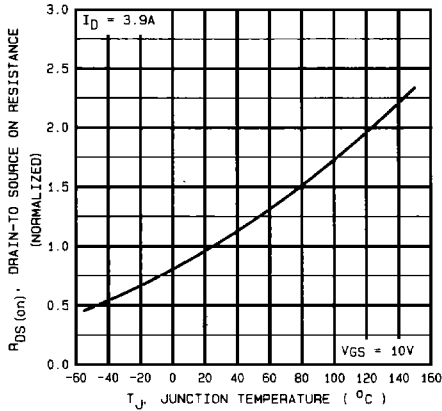

Fig. 4aa – Normalized On-Resistance Vs. Temperature IRFAG40

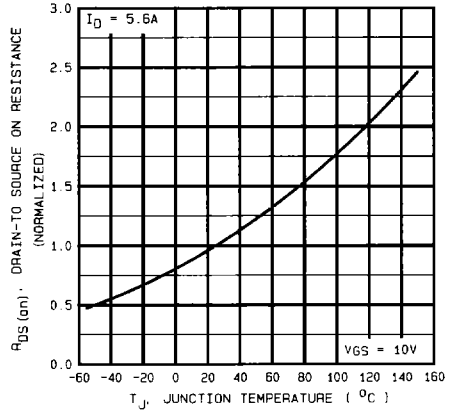

Fig. 4bb – Normalized On-Resistance Vs. Temperature IRFAG50

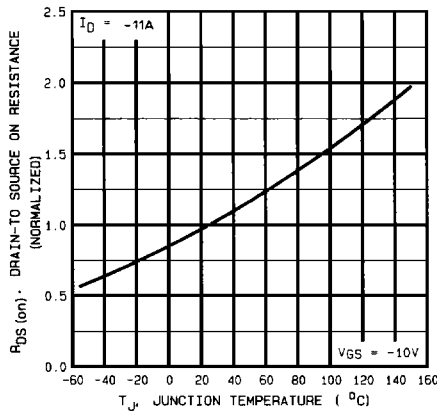

Fig. 4cc – Normalized On-Resistance Vs. Temperature IRF9130

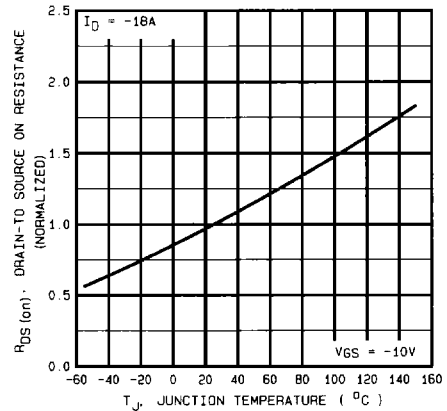

Fig. 4dd – Normalized On-Resistance Vs. Temperature IRF9140

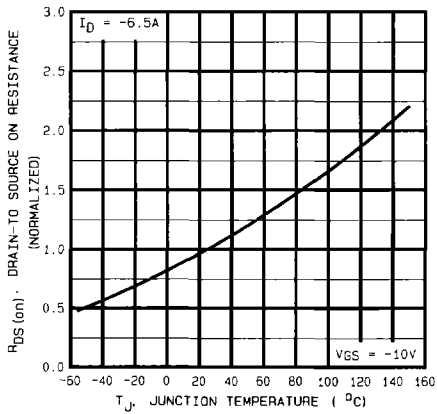

Fig. 4ee - Normalized On-Resistance Vs. Temperature
IRF9230

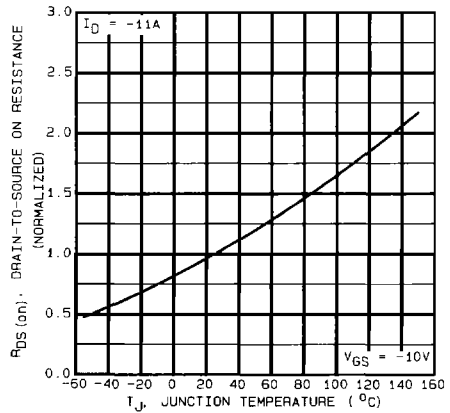

Fig. 4ff - Normalized On-Resistance Vs. Temperature
IRF9240

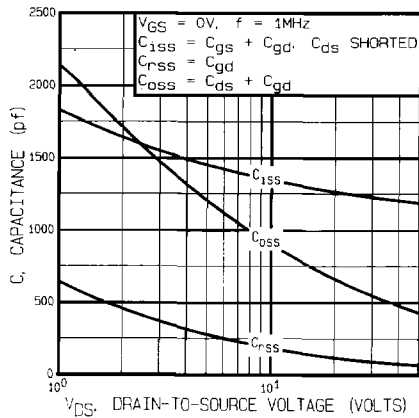

Fig. 5a - Typical Capacitance Vs. Drain-to-Source Voltage
IRF034

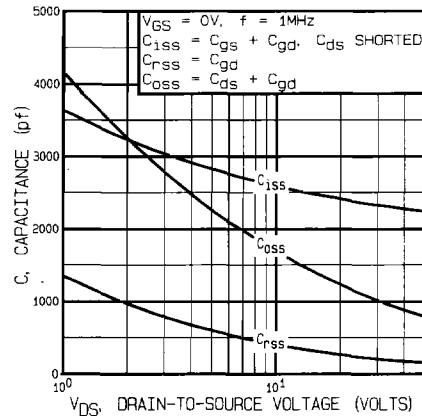

Fig. 5b - Typical Capacitance Vs. Drain-to-Source Voltage
IRF044

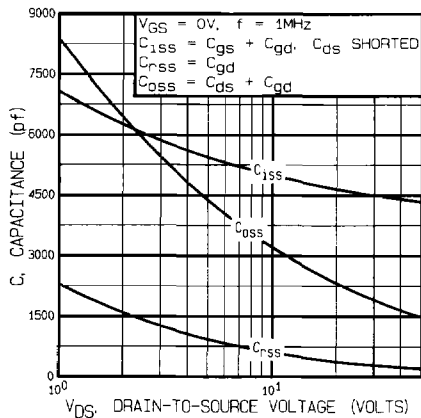

Fig. 5c - Typical Capacitance Vs. Drain-to-Source Voltage
IRF054

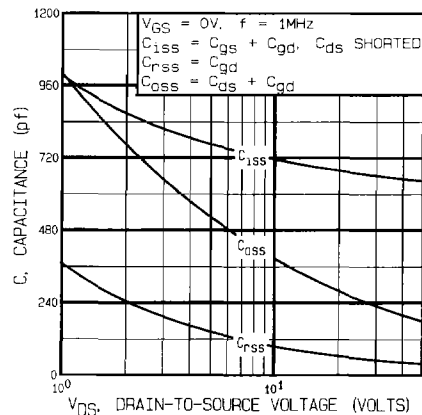

Fig. 5d - Typical Capacitance Vs. Drain-to-Source Voltage
IRF130

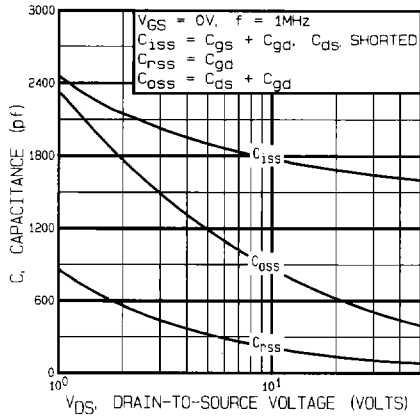

Fig. 5e - Typical Capacitance Vs. Drain-to-Source Voltage
IRF140

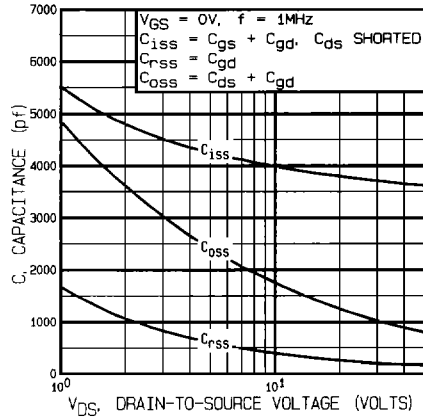

Fig. 5f - Typical Capacitance Vs. Drain-to-Source Voltage
IRF150

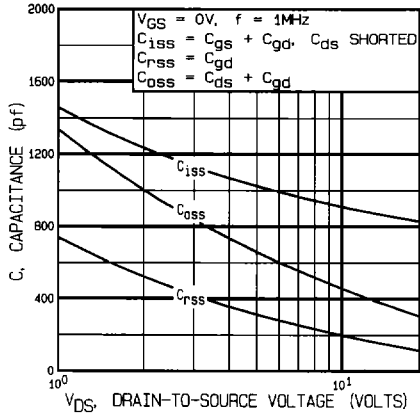

Fig. 5g - Typical Capacitance Vs. Drain-to-Source Voltage
IRF230

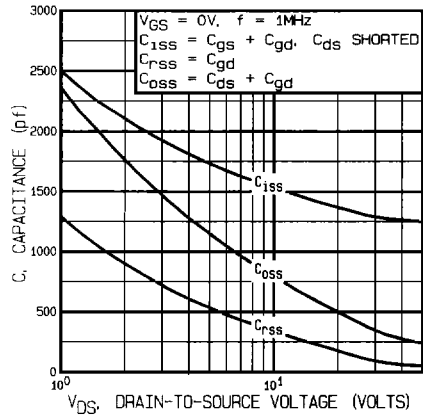

Fig. 5h - Typical Capacitance Vs. Drain-to-Source Voltage
IRF240

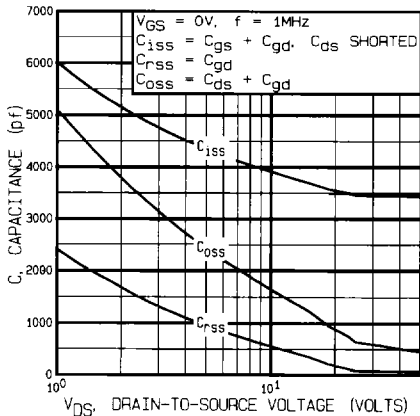

Fig. 5i - Typical Capacitance Vs. Drain-to-Source Voltage
IRF250

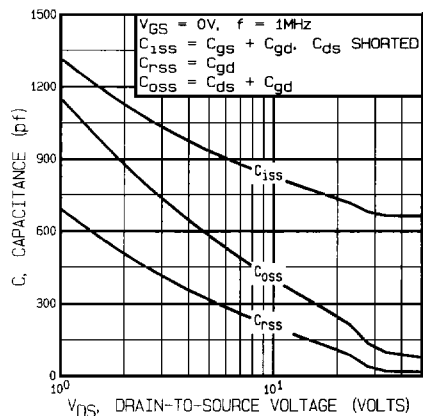

Fig. 5j - Typical Capacitance Vs. Drain-to-Source Voltage
IRF330

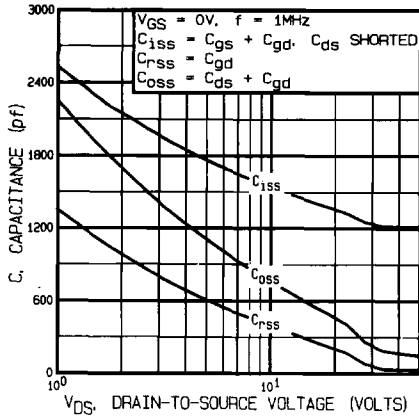

Fig. 5k - Typical Capacitance Vs. Drain-to-Source Voltage
IRF340

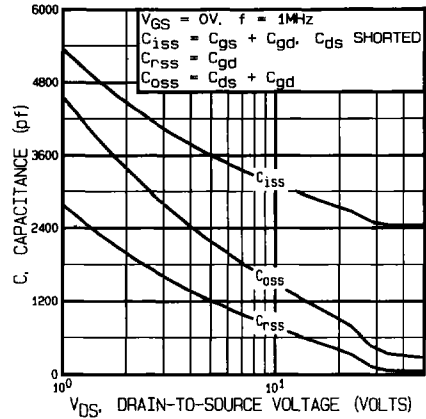

Fig. 5l - Typical Capacitance Vs. Drain-to-Source Voltage
IRF350

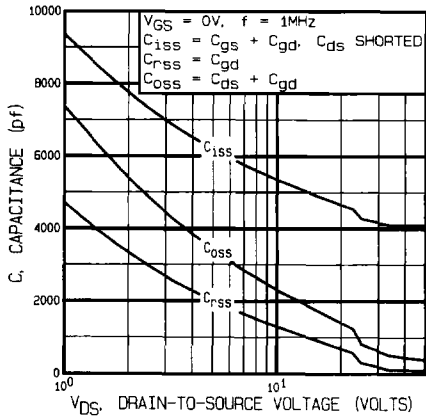

Fig. 5m - Typical Capacitance Vs. Drain-to-Source Voltage
IRF360

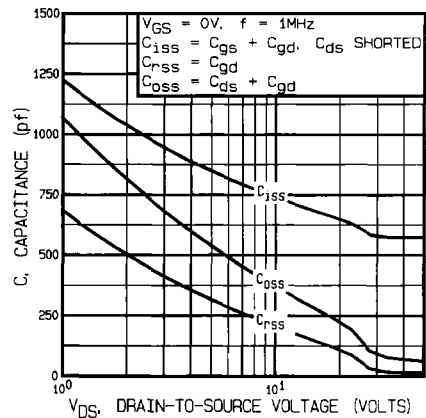

Fig. 5n - Typical Capacitance Vs. Drain-to-Source Voltage
IRF430

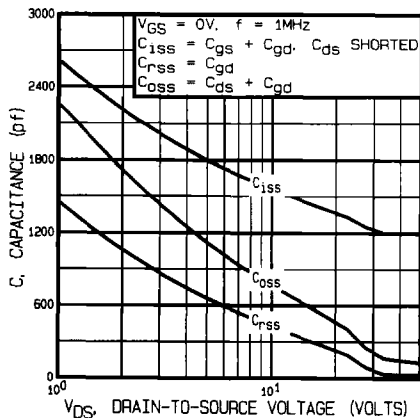

Fig. 5o - Typical Capacitance Vs. Drain-to-Source Voltage
IRF440

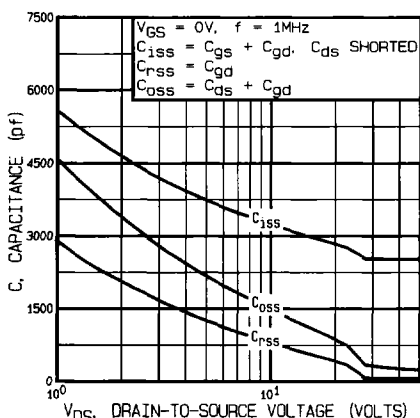

Fig. 5p - Typical Capacitance Vs. Drain-to-Source Voltage
IRF450

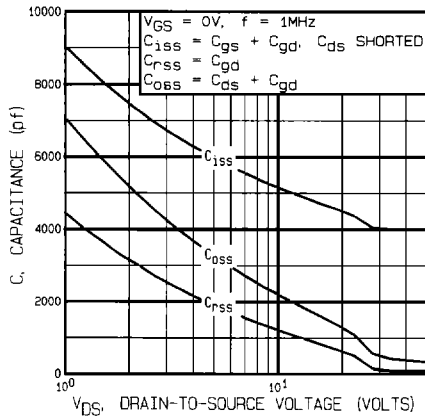

Fig. 5q - Typical Capacitance Vs. Drain-to-Source Voltage IRF460

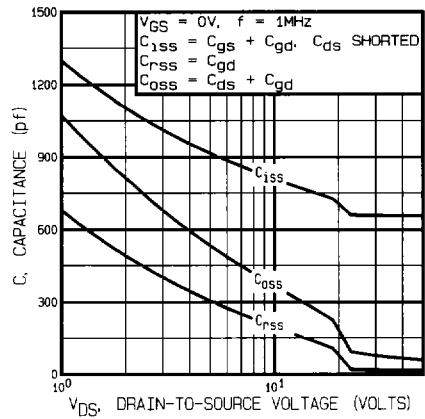

Fig. 5r - Typical Capacitance Vs. Drain-to-Source Voltage IRFAC30

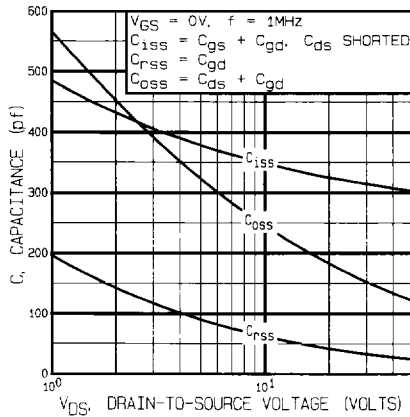

Fig. 5s - Typical Capacitance Vs. Drain-to-Source Voltage IRFAC40

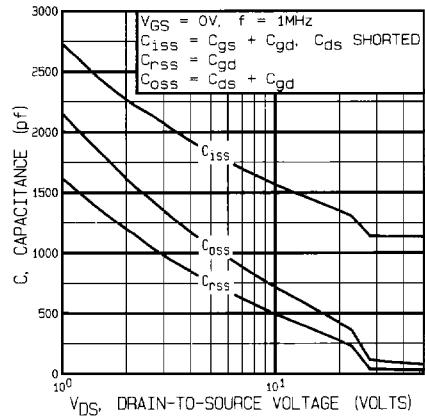

Fig. 5t - Typical Capacitance Vs. Drain-to-Source Voltage IRFAE30

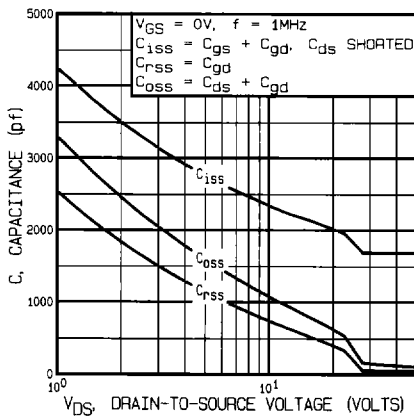

Fig. 5u - Typical Capacitance Vs. Drain-to-Source Voltage IRFAE40

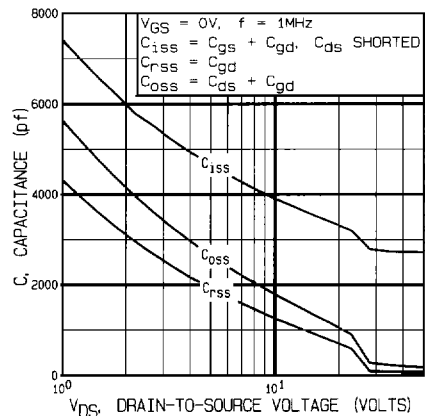

Fig. 5v - Typical Capacitance Vs. Drain-to-Source Voltage IRFAE50

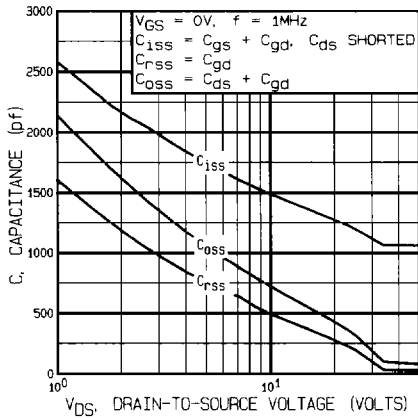

Fig. 5w - Typical Capacitance Vs. Drain-to-Source Voltage IRFAF30

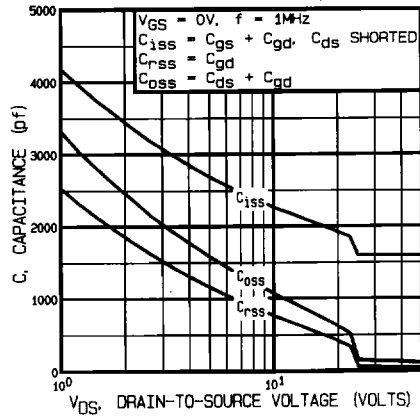

Fig. 5x - Typical Capacitance Vs. Drain-to-Source Voltage IRFAF40

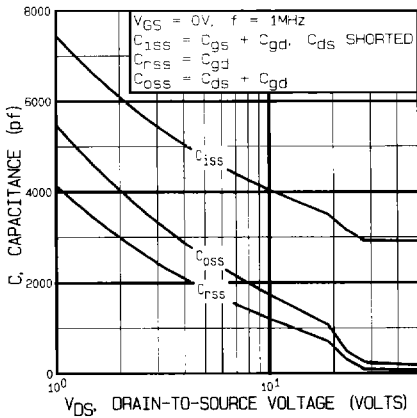

Fig. 5y - Typical Capacitance Vs. Drain-to-Source Voltage IRFAF50

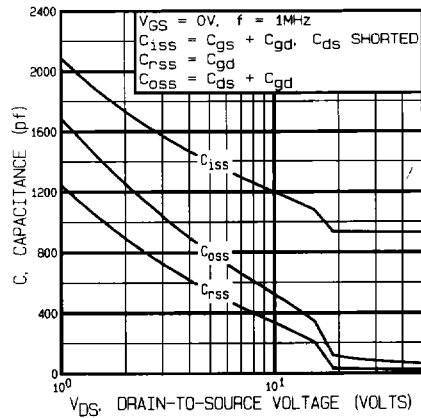

Fig. 5z - Typical Capacitance Vs. Drain-to-Source Voltage IRFAG30

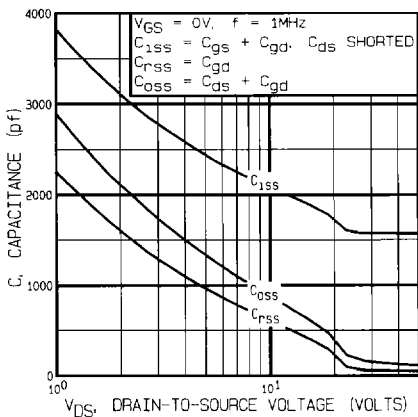

Fig. 5aa - Typical Capacitance Vs. Drain-to-Source Voltage IRFAG40

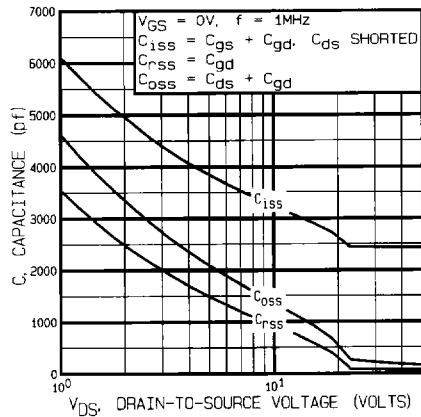

Fig. 5bb - Typical Capacitance Vs. Drain-to-Source Voltage IRFAG50

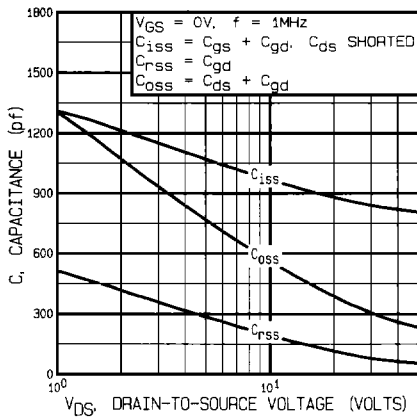

Fig. 5cc – Typical Capacitance Vs. Drain-to-Source Voltage IRF9130

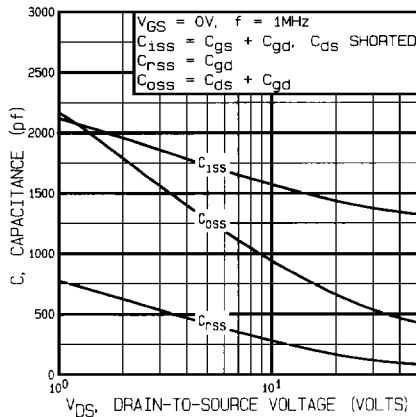

Fig. 5dd – Typical Capacitance Vs. Drain-to-Source Voltage IRF9140

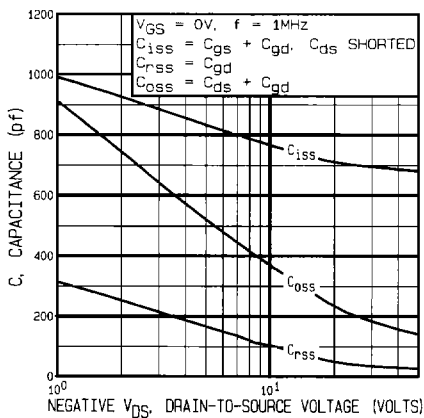

Fig. 5ee – Typical Capacitance Vs. Drain-to-Source Voltage IRF9230

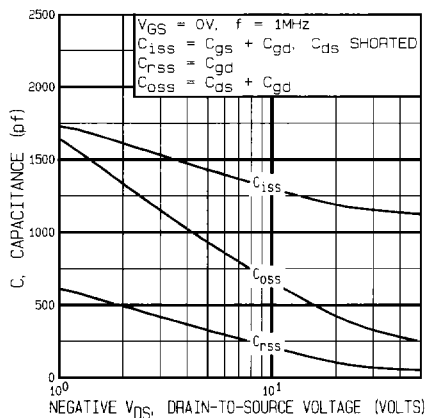

Fig. 5ff – Typical Capacitance Vs. Drain-to-Source Voltage IRF9240

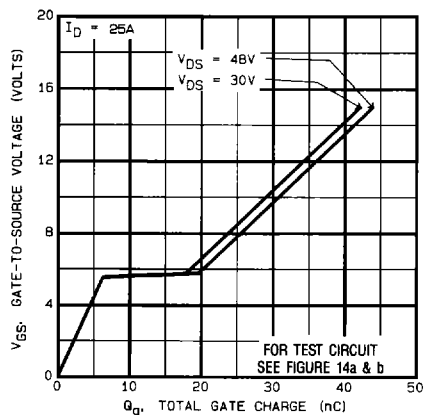

Fig. 6a – Typical Gate Charge Vs. Gate-to-Source Voltage IRF034

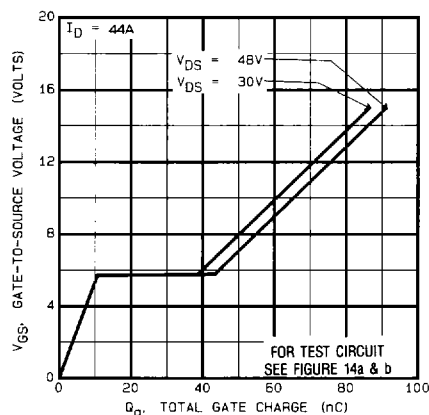

Fig. 6b – Typical Gate Charge Vs. Gate-to-Source Voltage IRF044

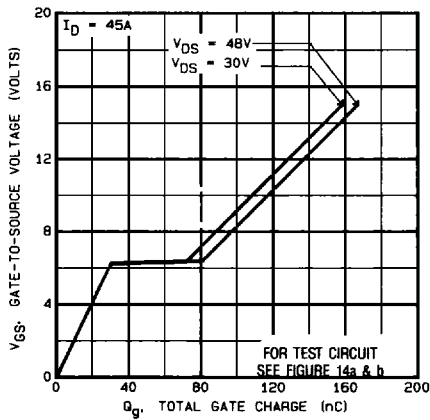

Fig. 6c - Typical Gate Charge Vs. Gate-to-Source Voltage IRF054

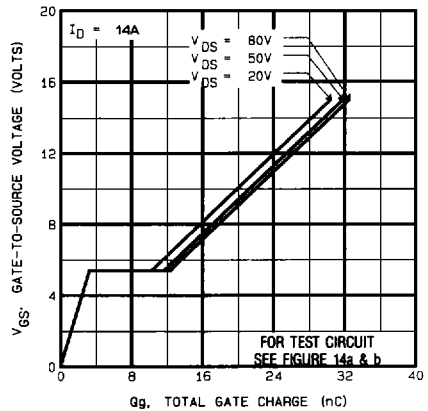

Fig. 6d - Typical Gate Charge Vs. Gate-to-Source Voltage IRF130

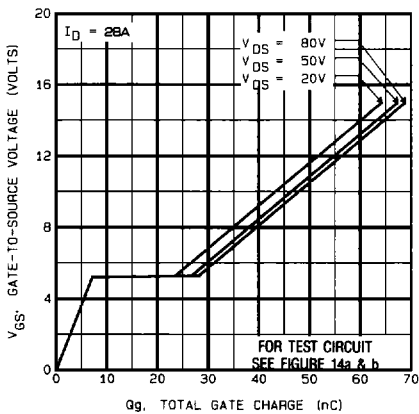

Fig. 6e - Typical Gate Charge Vs. Gate-to-Source Voltage IRF140

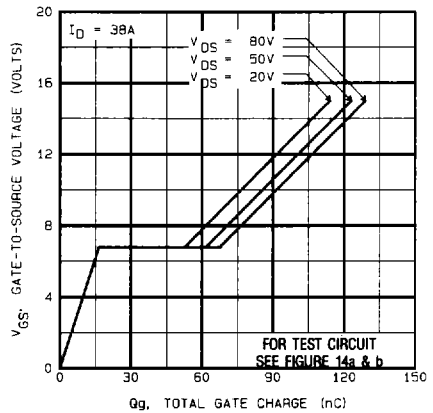

Fig. 6f - Typical Gate Charge Vs. Gate-to-Source Voltage IRF150

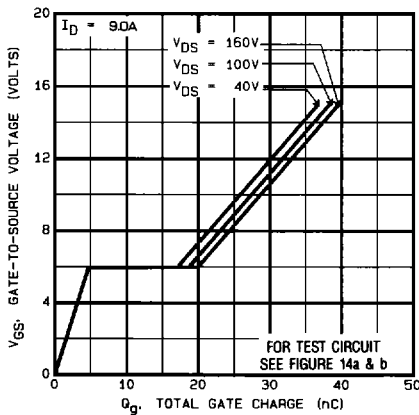

Fig. 6g - Typical Gate Charge Vs. Gate-to-Source Voltage IRF230

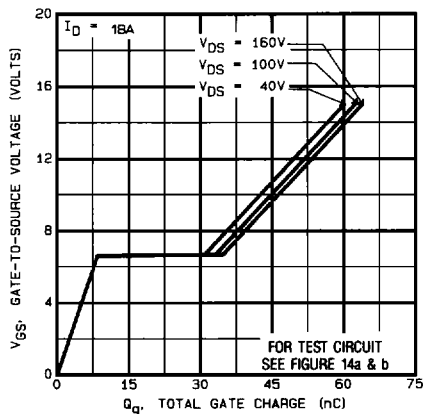

Fig. 6h - Typical Gate Charge Vs. Gate-to-Source Voltage IRF240

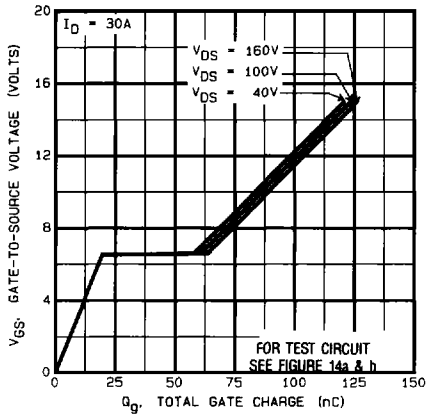

Fig. 6i - Typical Gate Charge Vs. Gate-to-Source Voltage
IRF250

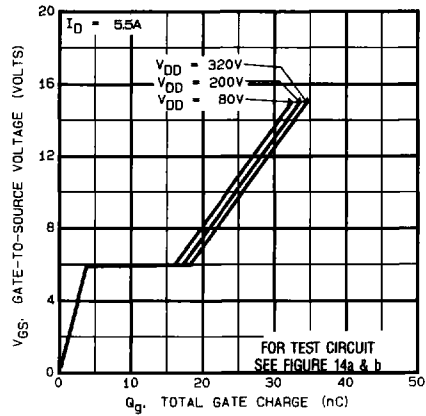

Fig. 6j - Typical Gate Charge Vs. Gate-to-Source Voltage
IRF330

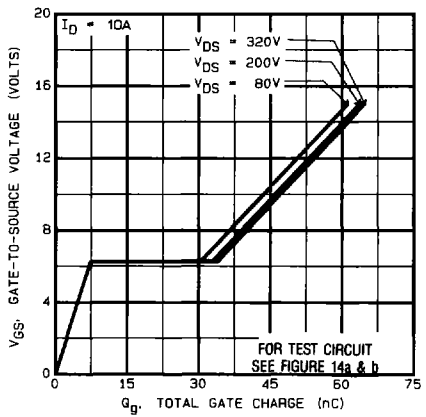

Fig. 6k - Typical Gate Charge Vs. Gate-to-Source Voltage
IRF340

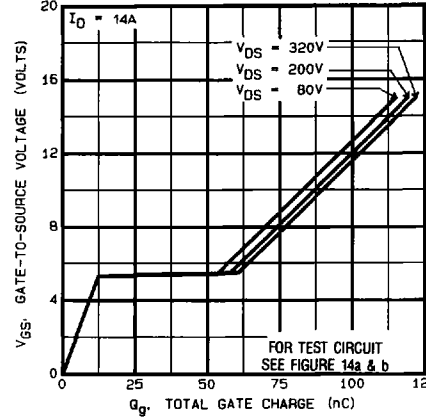

Fig. 6l - Typical Gate Charge Vs. Gate-to-Source Voltage
IRF350

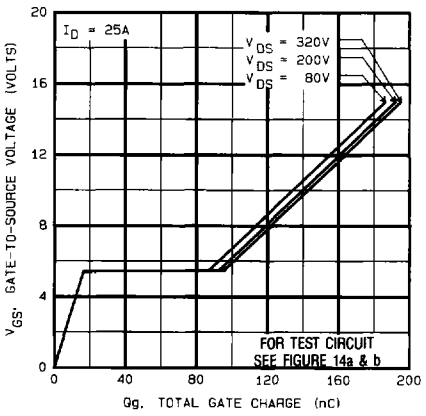

Fig. 6m - Typical Gate Charge Vs. Gate-to-Source Voltage
IRF360

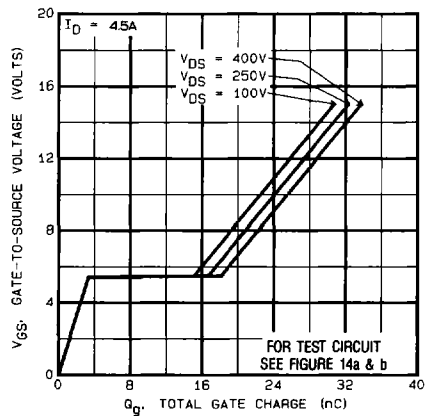

Fig. 6n - Typical Gate Charge Vs. Gate-to-Source Voltage
IRF430

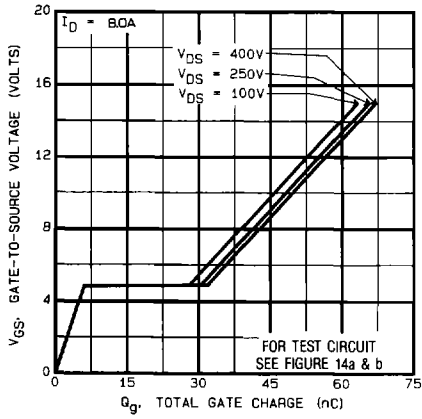

Fig. 6o - Typical Gate Charge Vs. Gate-to-Source Voltage IRF440

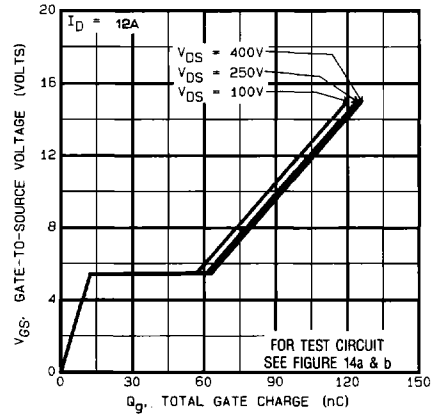

Fig. 6p - Typical Gate Charge Vs. Gate-to-Source Voltage IRF450

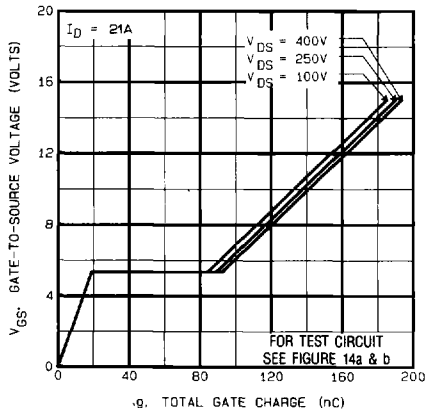

Fig. 6q - Typical Gate Charge Vs. Gate-to-Source Voltage IRF460

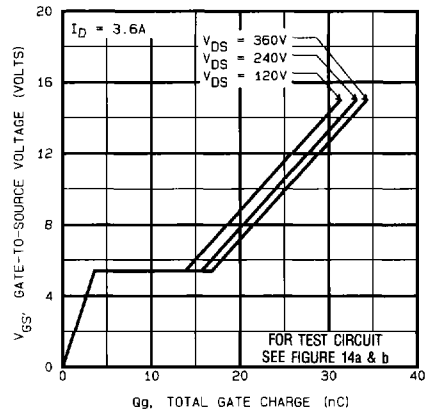

Fig. 6r - Typical Gate Charge Vs. Gate-to-Source Voltage IRFAC30

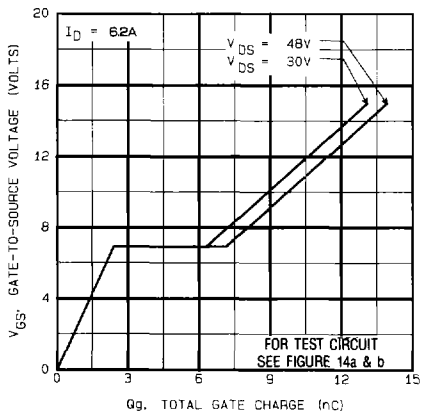

Fig. 6s - Typical Gate Charge Vs. Gate-to-Source Voltage IRFAC40

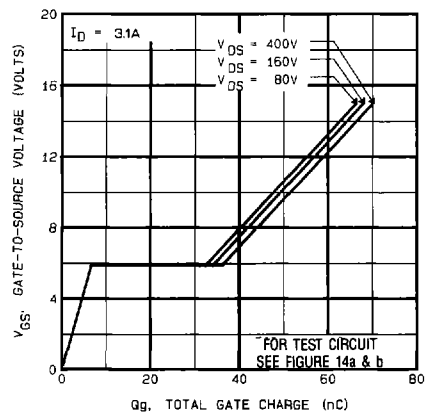

Fig. 6t - Typical Gate Charge Vs. Gate-to-Source Voltage IRFAE30

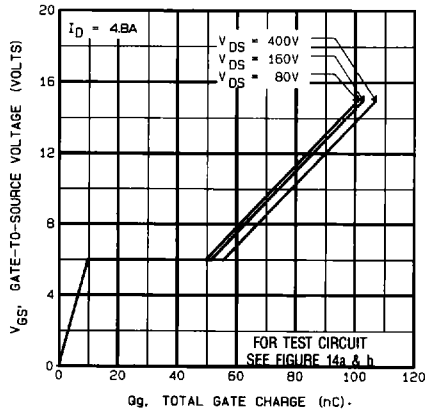

Fig. 6u - Typical Gate Charge Vs. Gate-to-Source Voltage IRFAE40

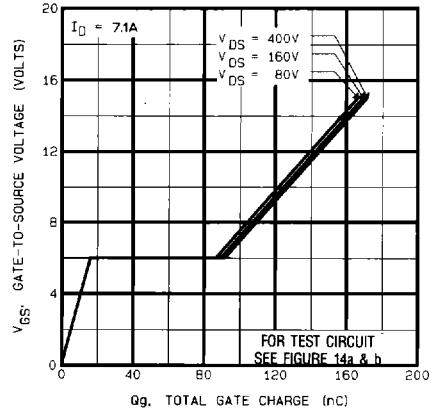

Fig. 6v - Typical Gate Charge Vs. Gate-to-Source Voltage IRFAE50

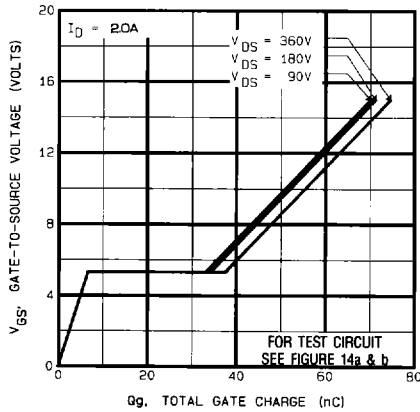

Fig. 6w - Typical Gate Charge Vs. Gate-to-Source Voltage IRFAF30

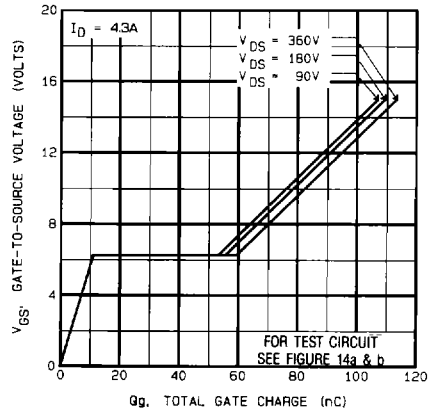

Fig. 6x - Typical Gate Charge Vs. Gate-to-Source Voltage IRFAF40

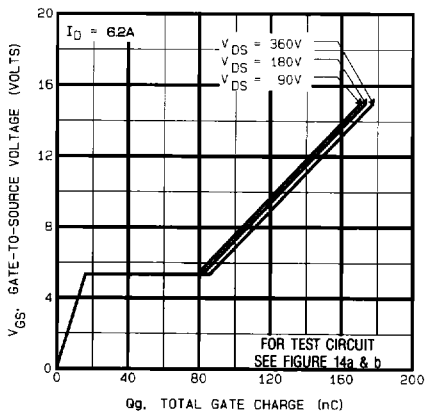

Fig. 6y - Typical Gate Charge Vs. Gate-to-Source Voltage IRFAF50

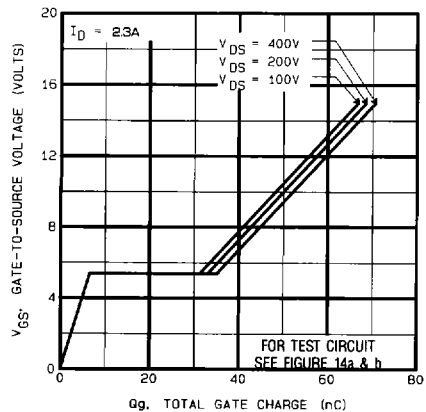

Fig. 6z - Typical Gate Charge Vs. Gate-to-Source Voltage IRFAG30

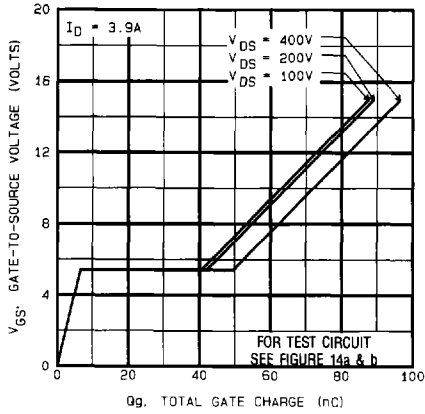

Fig. 6aa - Typical Gate Charge Vs. Gate-to-Source Voltage IRFAG40

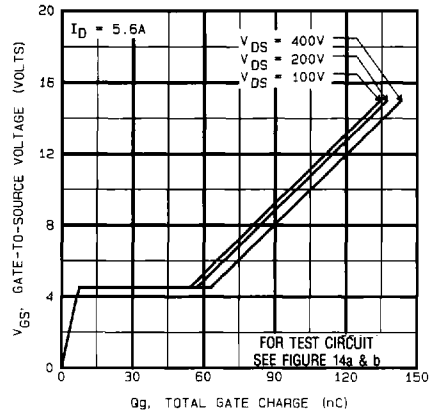

Fig. 6bb - Typical Gate Charge Vs. Gate-to-Source Voltage IRFAG50

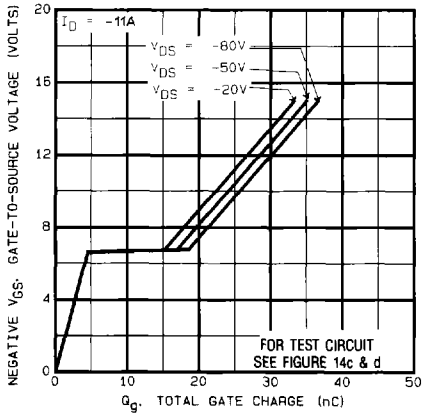

Fig. 6cc - Typical Gate Charge Vs. Gate-to-Source Voltage IRF9130

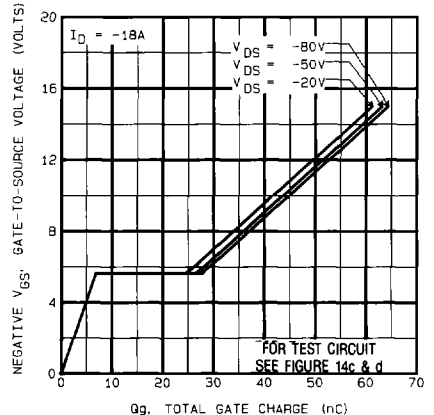

Fig. 6dd - Typical Gate Charge Vs. Gate-to-Source Voltage IRF9140

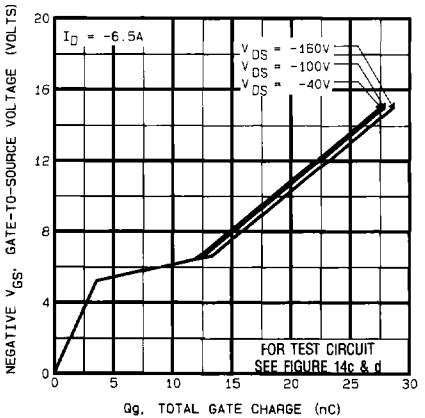

Fig. 6ee - Typical Gate Charge Vs. Gate-to-Source Voltage IRF9230

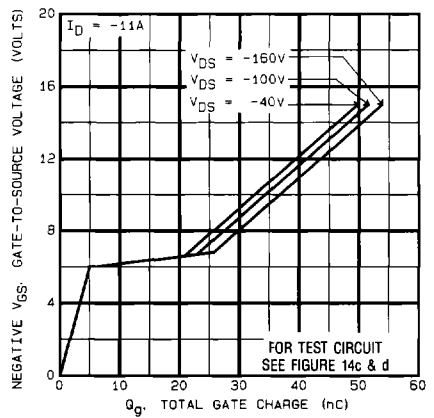
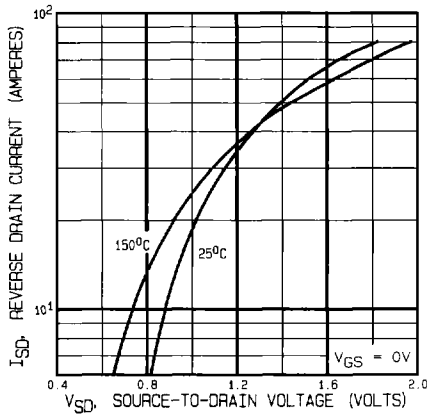
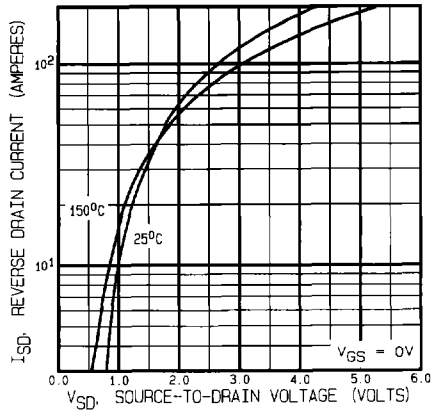
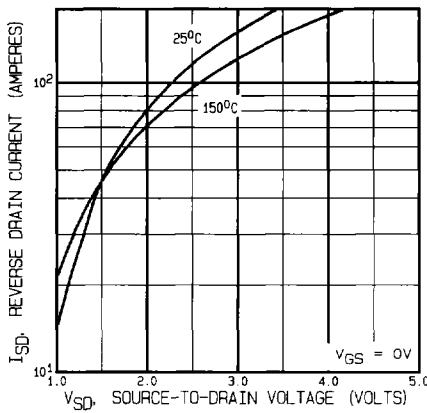
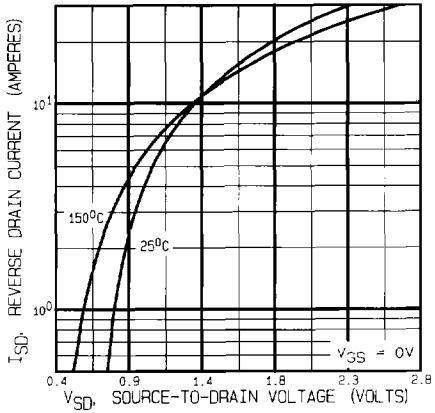
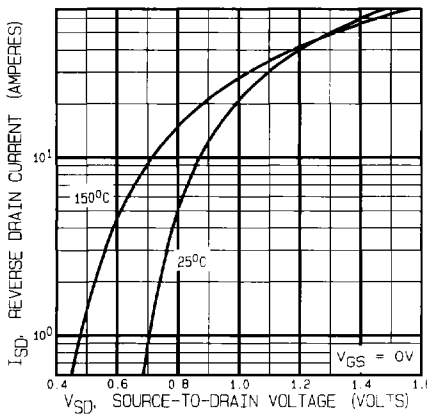
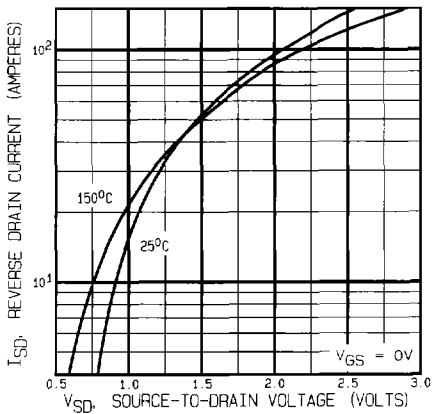

Fig. 6ff - Typical Gate Charge Vs. Gate-to-Source Voltage IRF9240

**Fig. 7a – Typical Source-Drain Diode Forward Voltage
IRF034**

**Fig. 7b – Typical Source-Drain Diode Forward Voltage
IRF044**

**Fig. 7c – Typical Source-Drain Diode Forward Voltage
IRF054**

**Fig. 7d – Typical Source-Drain Diode Forward Voltage
IRF130**

**Fig. 7e – Typical Source-Drain Diode Forward Voltage
IRF140**

**Fig. 7f – Typical Source-Drain Diode Forward Voltage
IRF150**

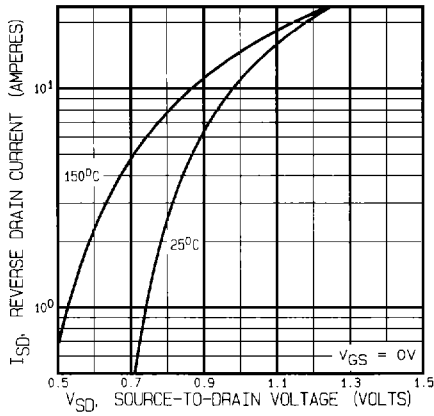

Fig. 7g – Typical Source-Drain Diode Forward Voltage
IRF230

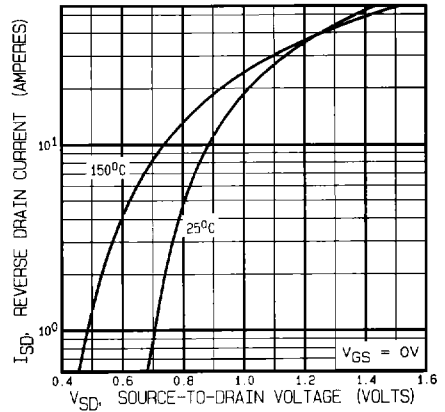

Fig. 7h – Typical Source-Drain Diode Forward Voltage
IRF240

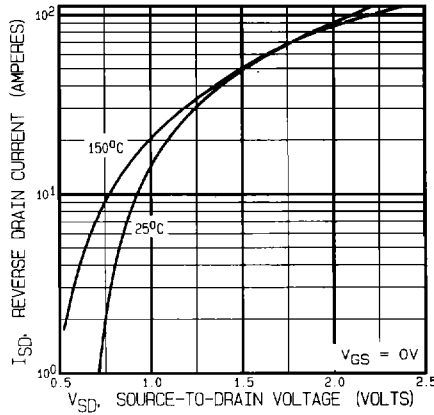

Fig. 7i – Typical Source-Drain Diode Forward Voltage
IRF250

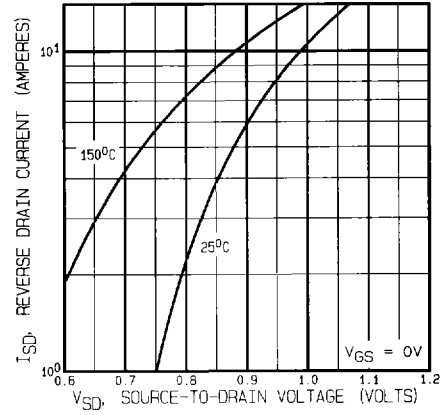

Fig. 7j – Typical Source-Drain Diode Forward Voltage
IRF330

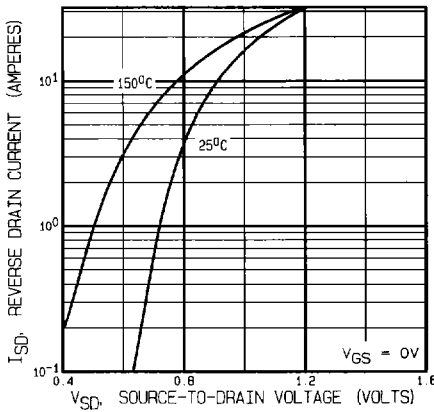

Fig. 7k – Typical Source-Drain Diode Forward Voltage
IRF340

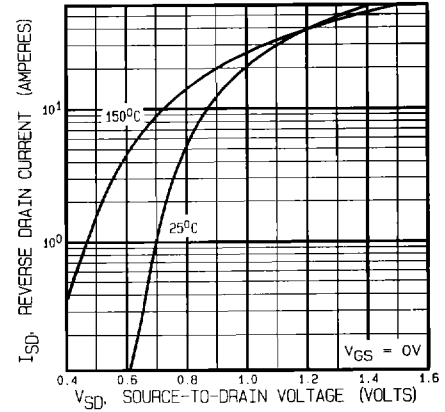

Fig. 7l – Typical Source-Drain Diode Forward Voltage
IRF350

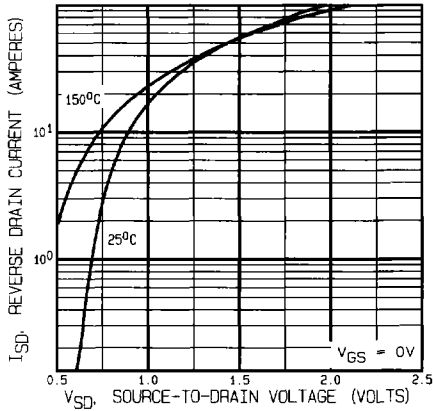

Fig. 7m - Typical Source-Drain Diode Forward Voltage IRF360

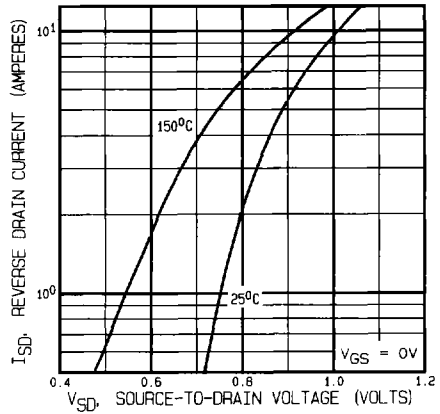

Fig. 7n - Typical Source-Drain Diode Forward Voltage IRF430

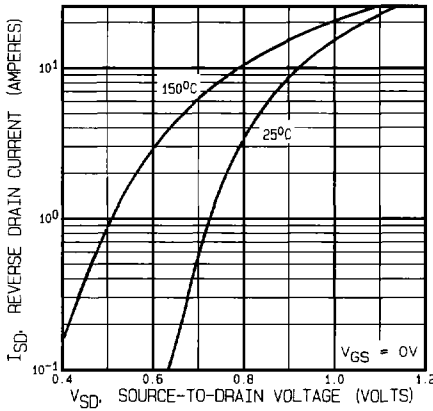

Fig. 7o - Typical Source-Drain Diode Forward Voltage IRF440

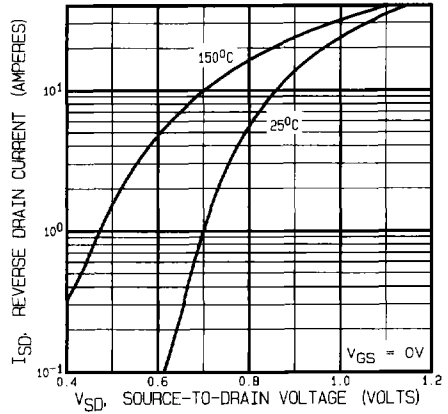

Fig. 7p - Typical Source-Drain Diode Forward Voltage IRF450

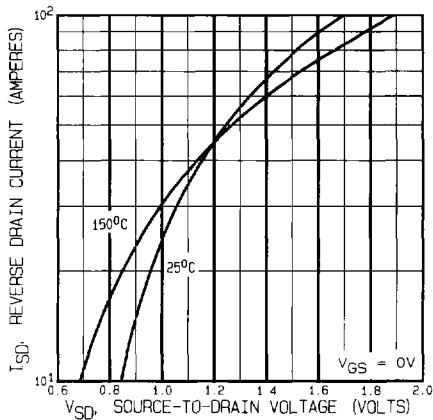

Fig. 7q - Typical Source-Drain Diode Forward Voltage IRF460

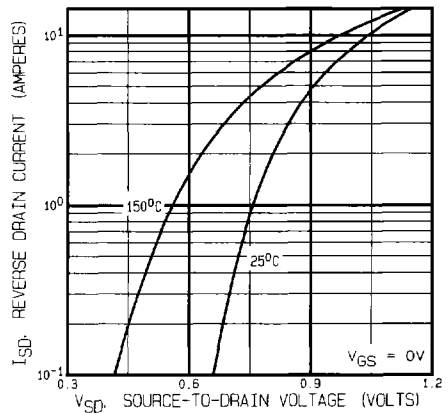

Fig. 7r - Typical Source-Drain Diode Forward Voltage IRFAC30

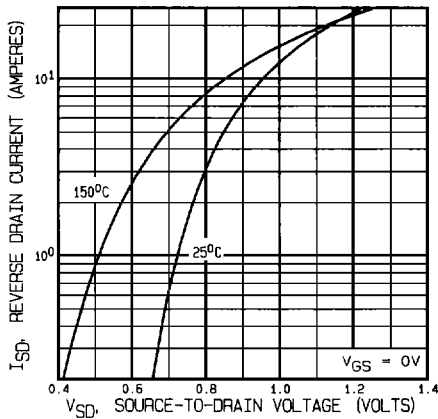

Fig. 7a – Typical Source-Drain Diode Forward Voltage
IRFAC40

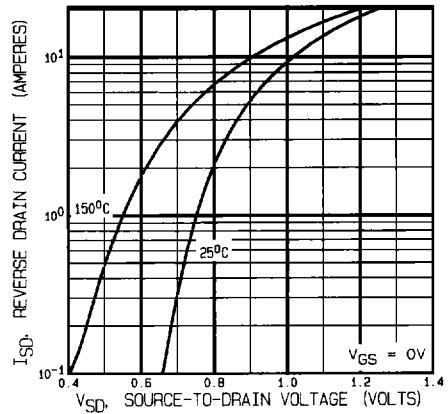

Fig. 7t – Typical Source-Drain Diode Forward Voltage
IRFAE30

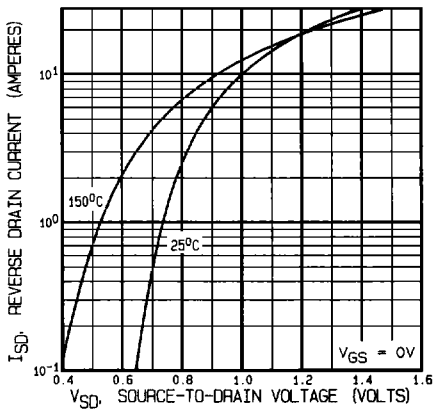

Fig. 7u – Typical Source-Drain Diode Forward Voltage
IRFAE30

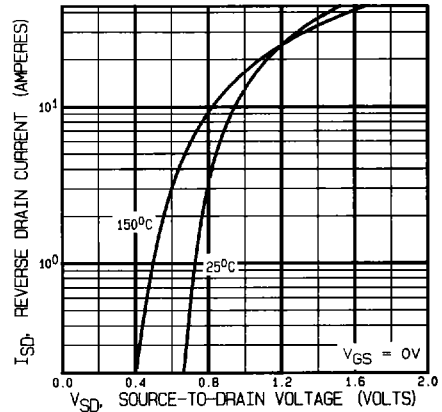

Fig. 7v – Typical Source-Drain Diode Forward Voltage
IRFAE50

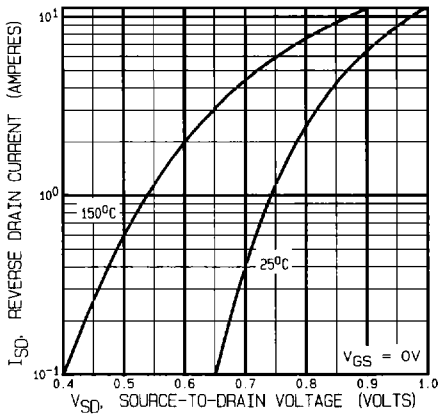

Fig. 7w – Typical Source-Drain Diode Forward Voltage
IRFAF30

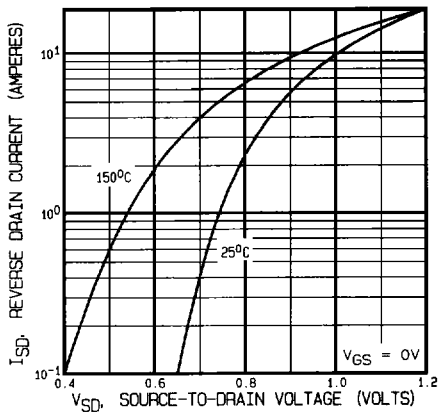

Fig. 7x – Typical Source-Drain Diode Forward Voltage
IRFAF40

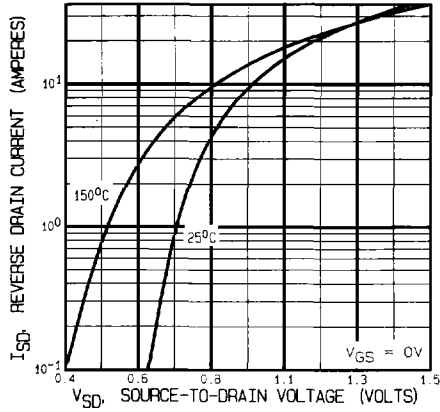

Fig. 7y - Typical Source-Drain Diode Forward Voltage IRFAF50

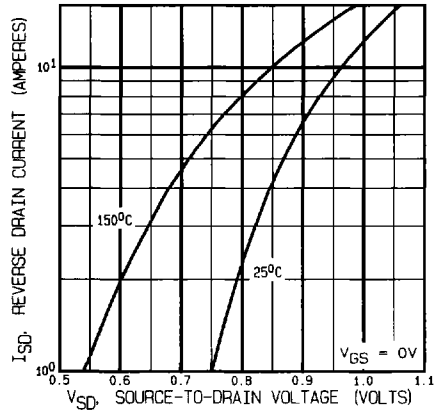

Fig. 7z - Typical Source-Drain Diode Forward Voltage IRFAG30

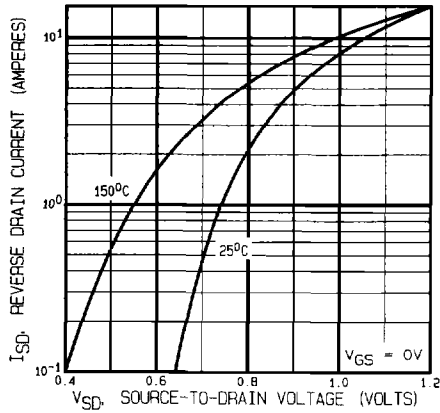

Fig. 7aa - Typical Source-Drain Diode Forward Voltage IRFAG40

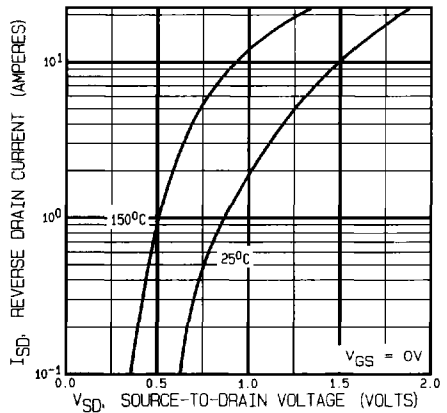

Fig. 7bb - Typical Source-Drain Diode Forward Voltage IRFAG50

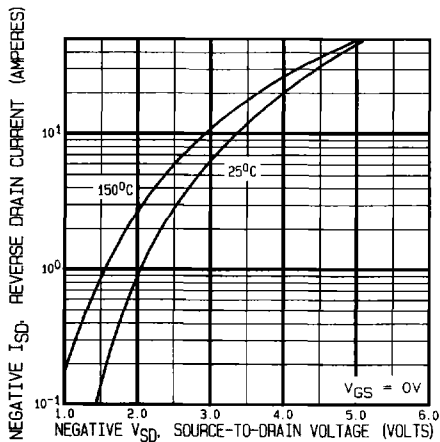

Fig. 7cc - Typical Source-Drain Diode Forward Voltage IRF9130

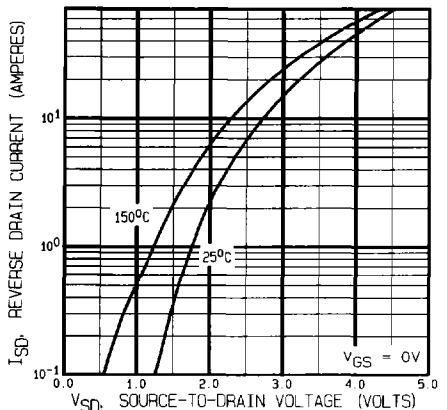
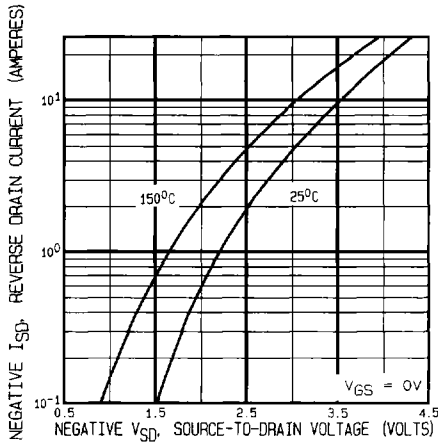
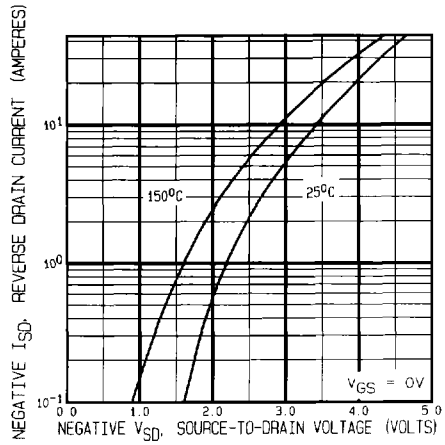

Fig. 7dd - Typical Source-Drain Diode Forward Voltage IRF9140

IRF Series Devices



**Fig. 7ee - Typical Source-Drain Diode Forward Voltage
IRF9230**



**Fig. 7ff - Typical Source-Drain Diode Forward Voltage
IRF9240**

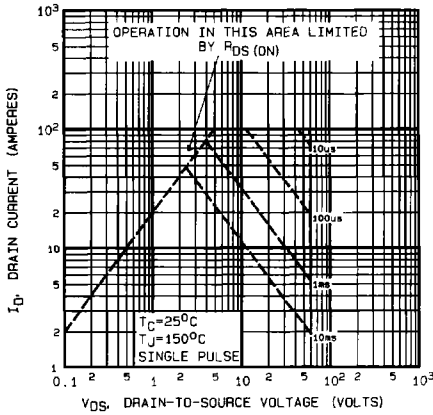

**Fig. 8a - Maximum Safe Operating Area
IRF034**

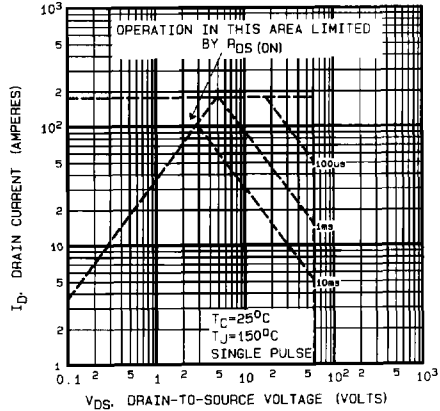

**Fig. 8b - Maximum Safe Operating Area
IRF044**

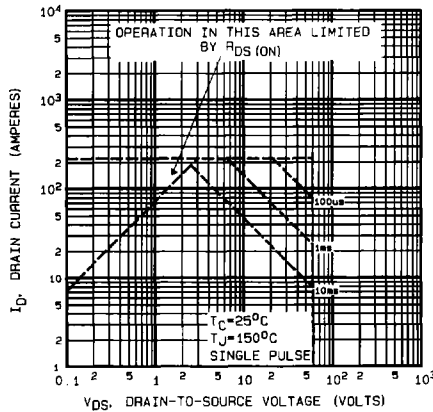

**Fig. 8c - Maximum Safe Operating Area
IRF054**

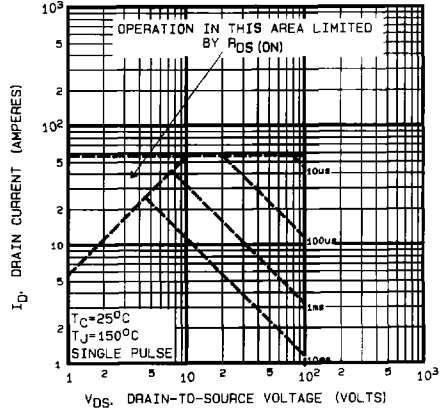

**Fig. 8d - Maximum Safe Operating Area
IRF130**

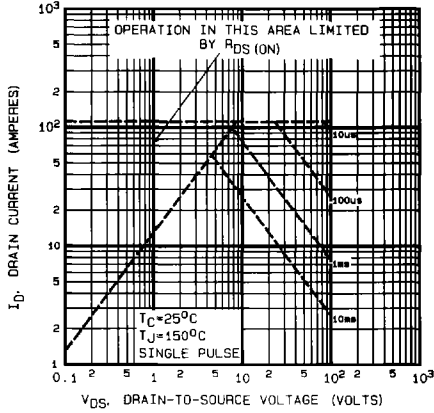

Fig. 8e - Maximum Safe Operating Area IRF140

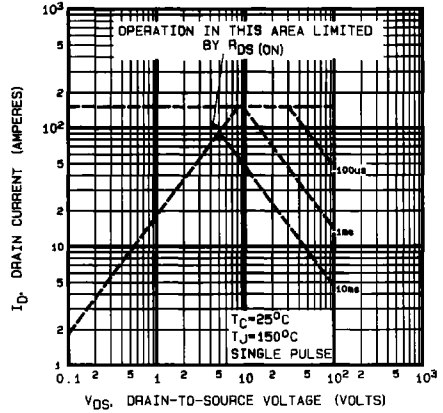

Fig. 8f - Maximum Safe Operating Area IRF150

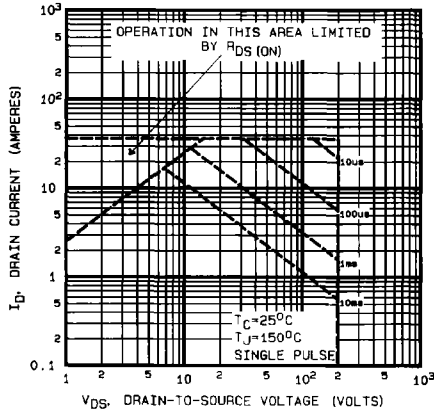

Fig. 8g - Maximum Safe Operating Area IRF230

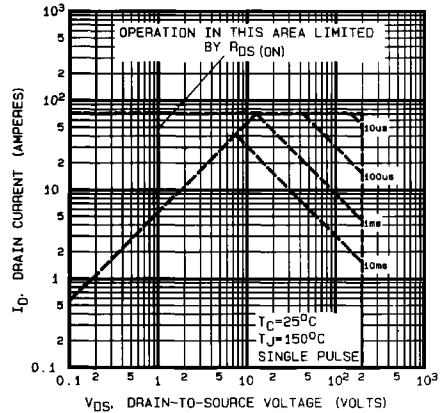

Fig. 8h - Maximum Safe Operating Area IRF240

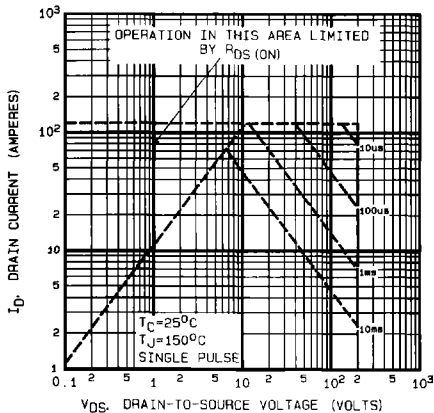

Fig. 8i - Maximum Safe Operating Area IRF250

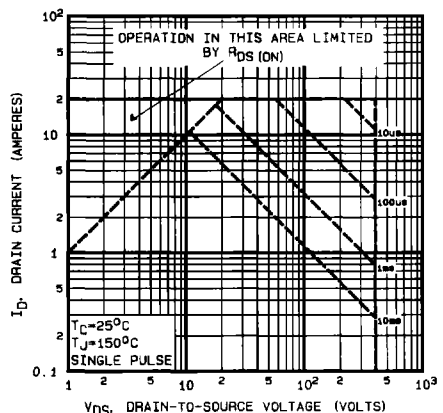

Fig. 8j - Maximum Safe Operating Area IRF330

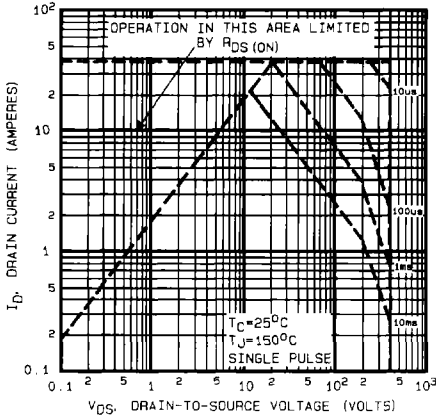

Fig. 8k - Maximum Safe Operating Area
IRF340

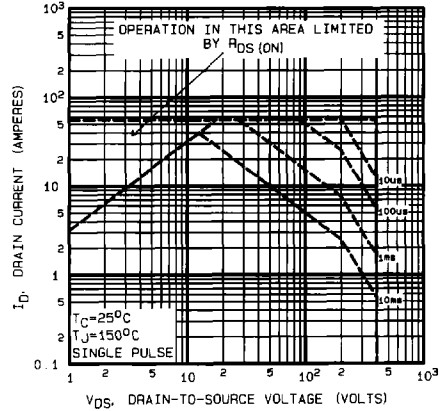

Fig. 8l - Maximum Safe Operating Area
IRF350

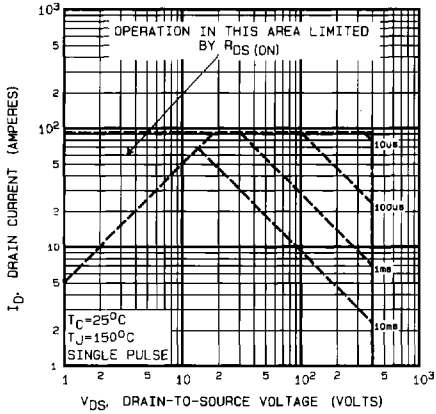

Fig. 8m - Maximum Safe Operating Area
IRF360

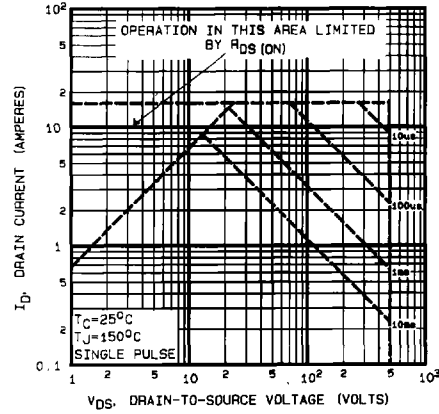

Fig. 8n - Maximum Safe Operating Area
IRF430

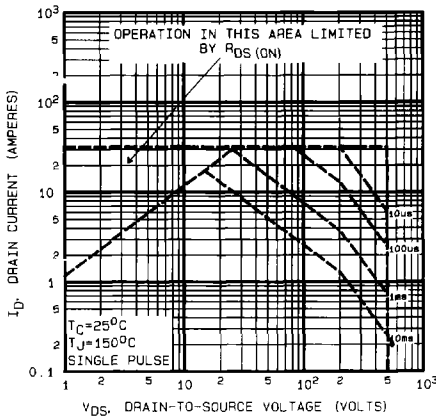

Fig. 8o. - Maximum Safe Operating Area
IRF440

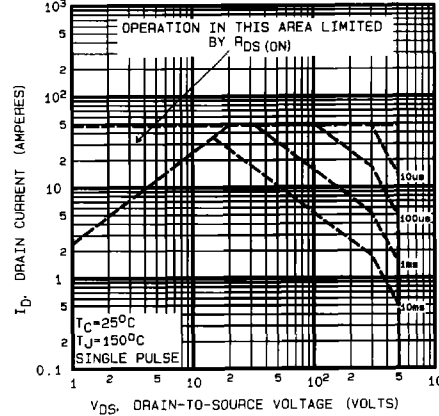

Fig. 8p - Maximum Safe Operating Area
IRF450

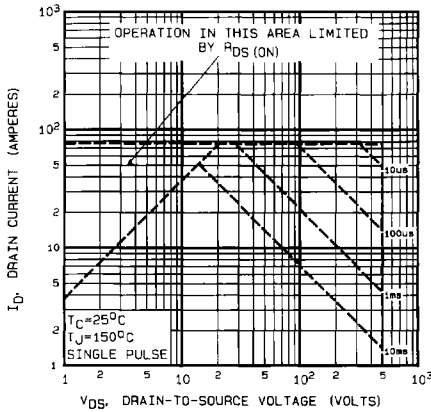

Fig. 8q - Maximum Safe Operating Area IRF460

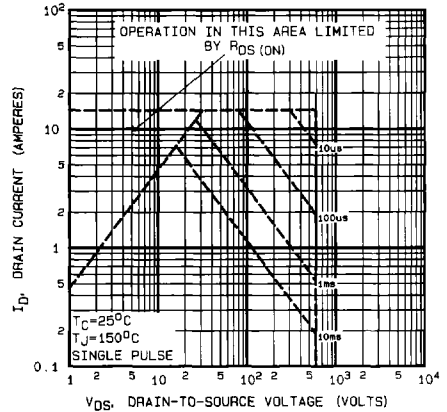

Fig. 8r - Maximum Safe Operating Area IRFAC30

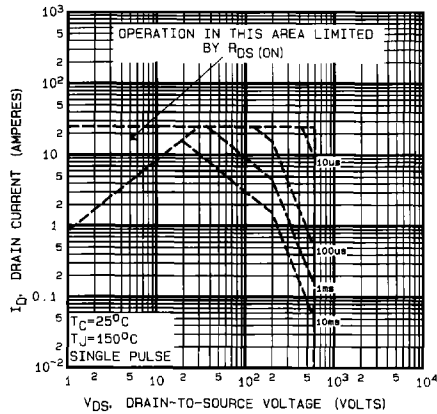

Fig. 8s - Maximum Safe Operating Area IRFAC40

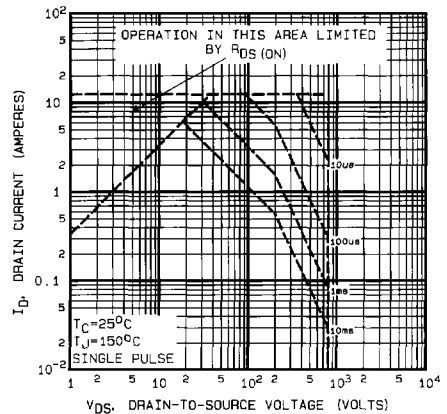

Fig. 8t - Maximum Safe Operating Area IRFAE30

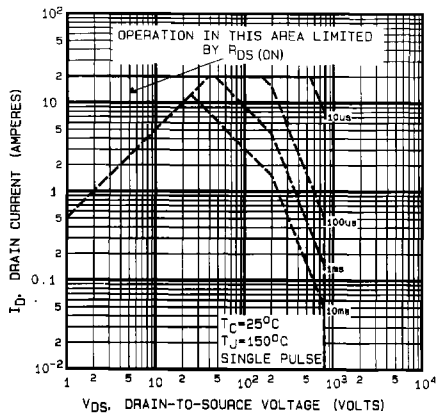

Fig. 8u - Maximum Safe Operating Area IRFAE40

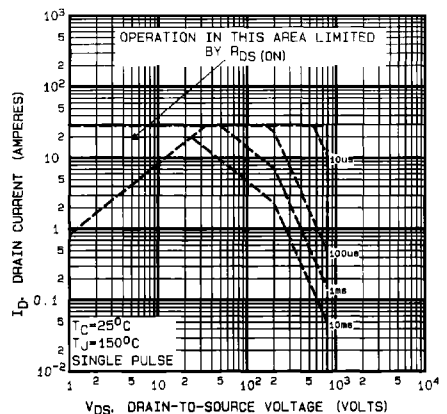

Fig. 8v - Maximum Safe Operating Area IRFAE50

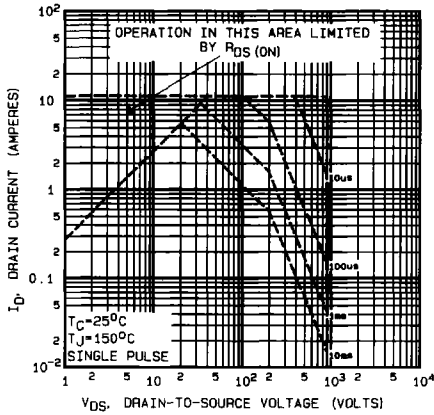

Fig. 8w – Maximum Safe Operating Area IRFAF30

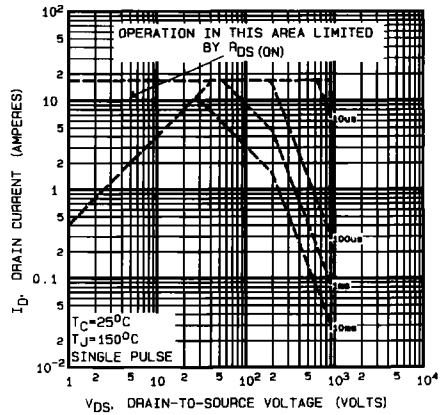

Fig. 8x – Maximum Safe Operating Area IRFAF40

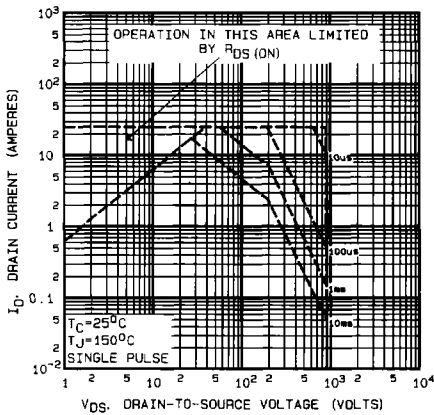

Fig. 8y – Maximum Safe Operating Area IRFAF50

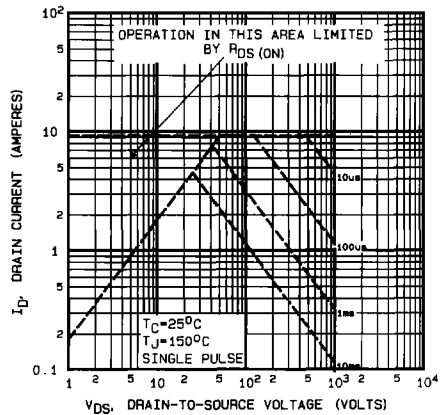

Fig. 8z – Maximum Safe Operating Area IRFAG30

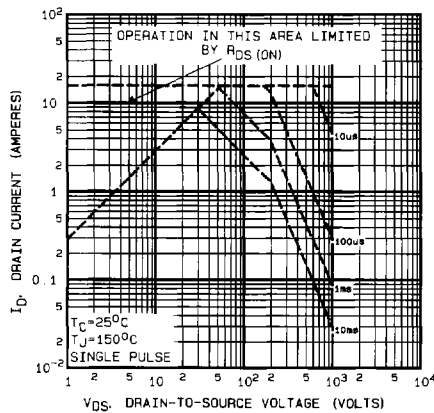

Fig. 8aa – Maximum Safe Operating Area IRFAG40

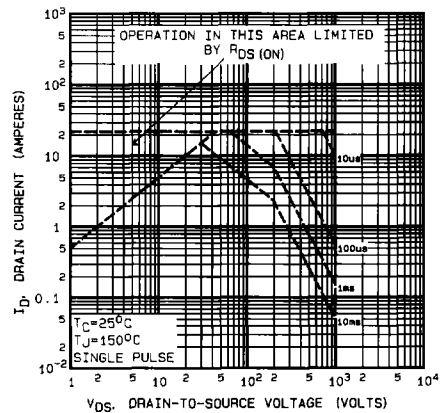

Fig. 8bb – Maximum Safe Operating Area IRFAG50

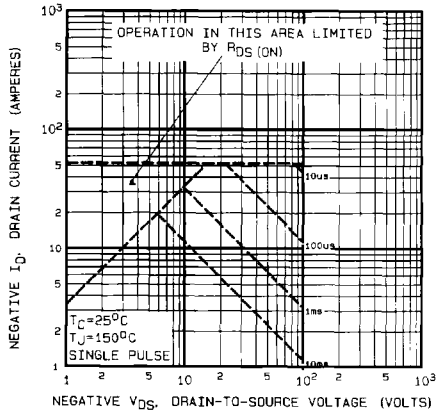

Fig. 8cc – Maximum Safe Operating Area IRF9130

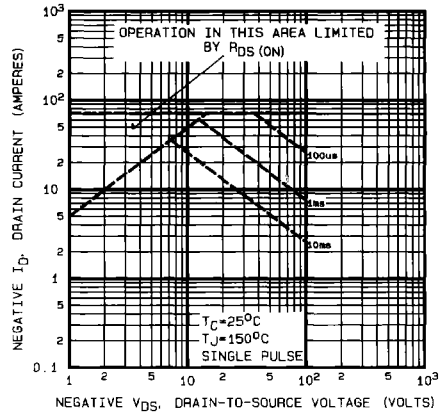

Fig. 8dd – Maximum Safe Operating Area IRF9140

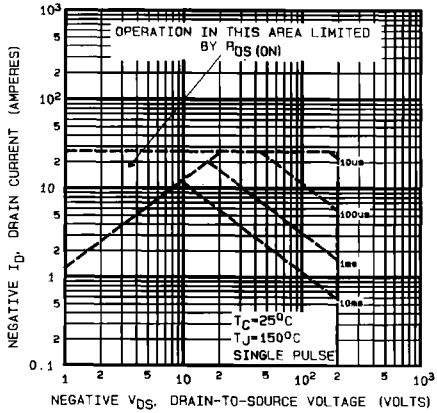

Fig. 8ee – Maximum Safe Operating Area IRF9230

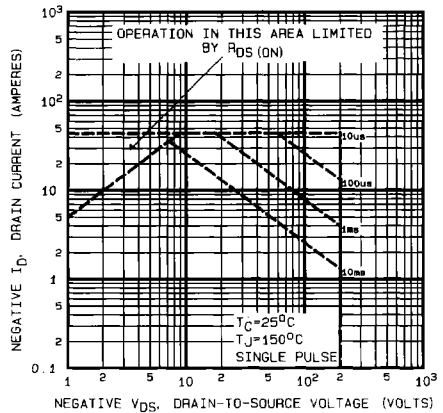

Fig. 8ff – Maximum Safe Operating Area IRF9240

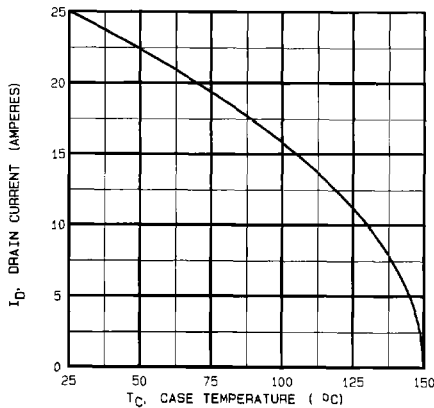

Fig. 9a – Maximum Drain Current Vs. Case Temperature IRF034

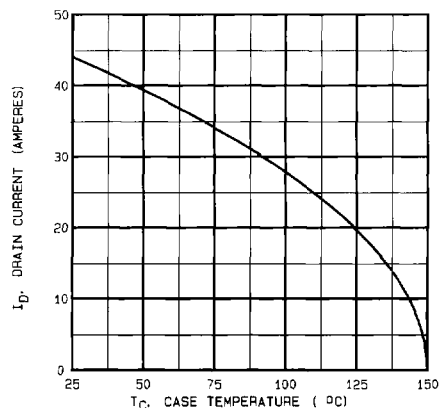

Fig. 9b – Maximum Drain Current Vs. Case Temperature IRF044

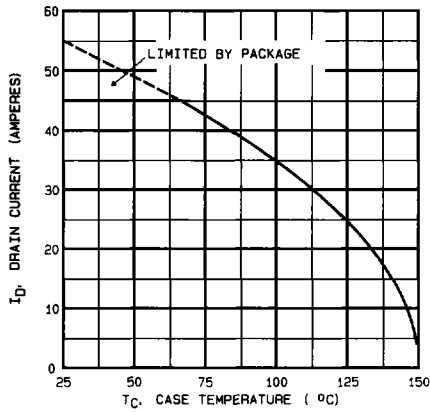

Fig. 9c - Maximum Drain Current Vs. Case Temperature IRF054

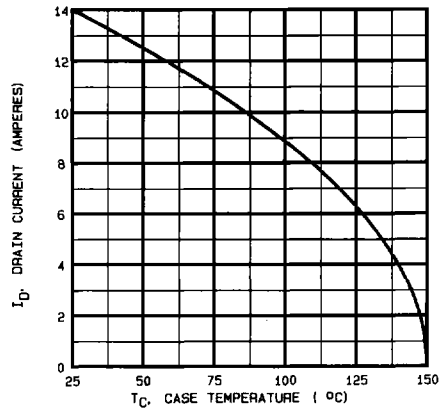

Fig. 9d - Maximum Drain Current Vs. Case Temperature IRF130

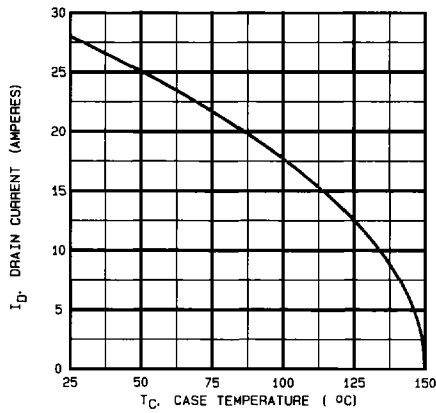

Fig. 9e - Maximum Drain Current Vs. Case Temperature IRF140

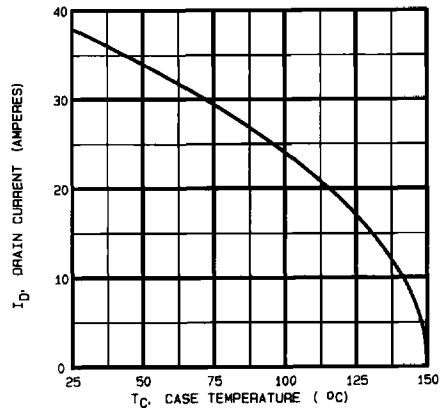

Fig. 9f - Maximum Drain Current Vs. Case Temperature IRF150

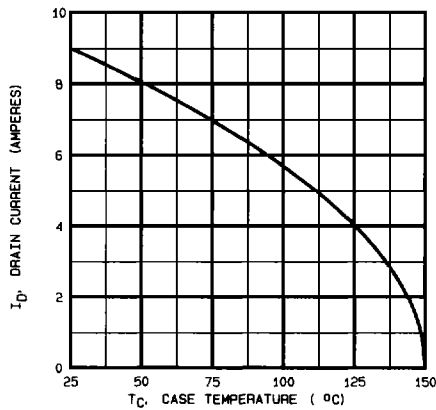

Fig. 9g - Maximum Drain Current Vs. Case Temperature IRF230

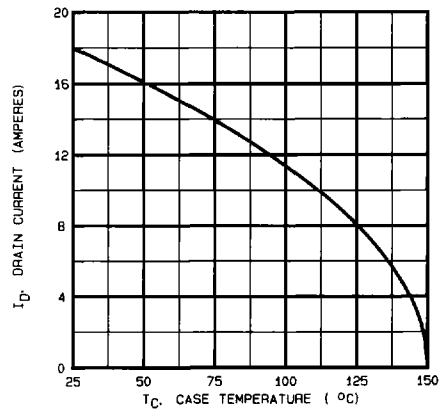

Fig. 9h - Maximum Drain Current Vs. Case Temperature IRF240

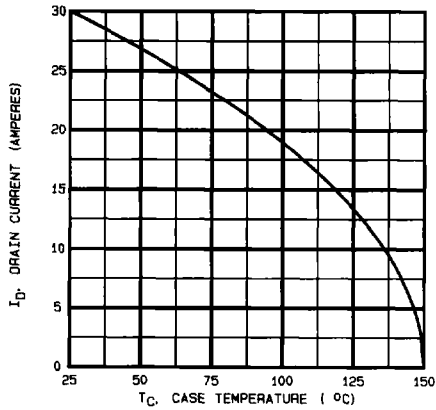

Fig. 9l – Maximum Drain Current Vs. Case Temperature
IRF250

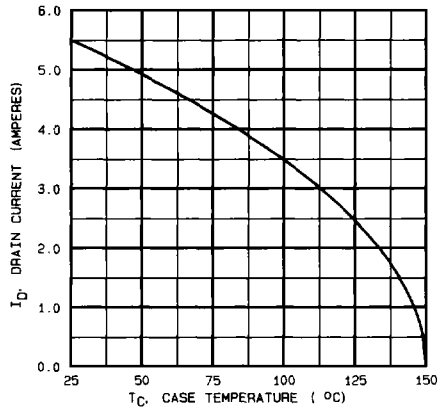

Fig. 9j – Maximum Drain Current Vs. Case Temperature
IRF330

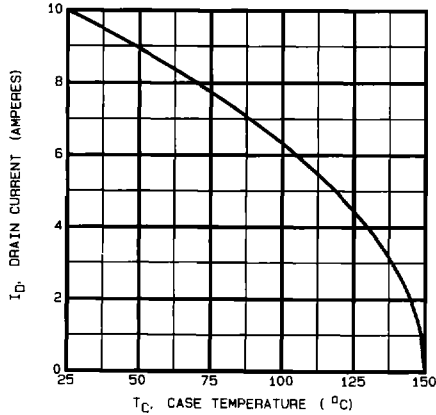

Fig. 9k – Maximum Drain Current Vs. Case Temperature
IRF340

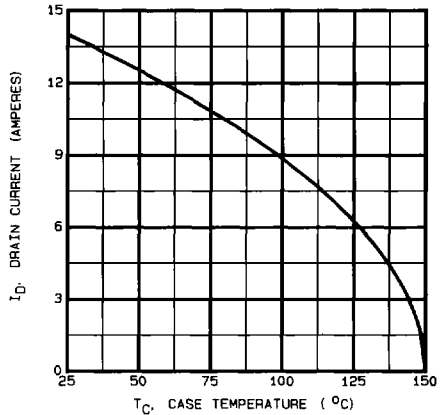

Fig. 9i – Maximum Drain Current Vs. Case Temperature
IRF350

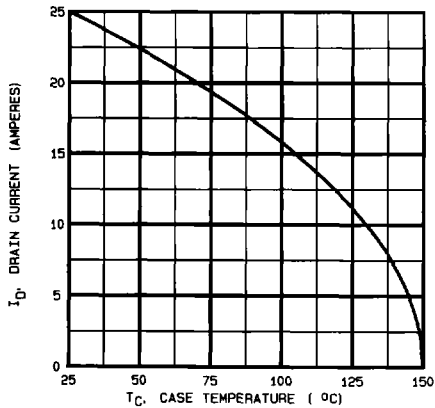

Fig. 9m – Maximum Drain Current Vs. Case Temperature
IRF360

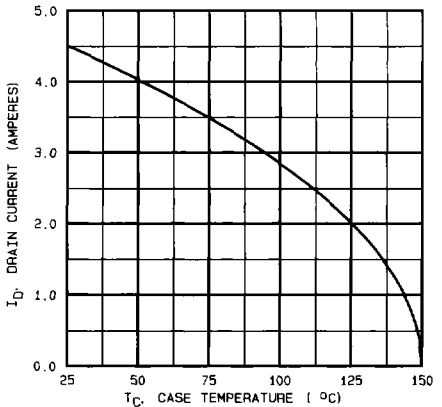

Fig. 9n – Maximum Drain Current Vs. Case Temperature
IRF430

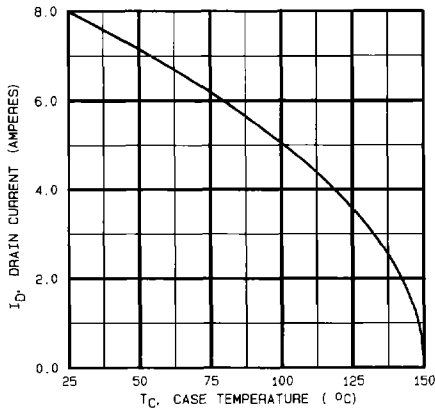

Fig. 9o - Maximum Drain Current Vs. Case Temperature
IRF440

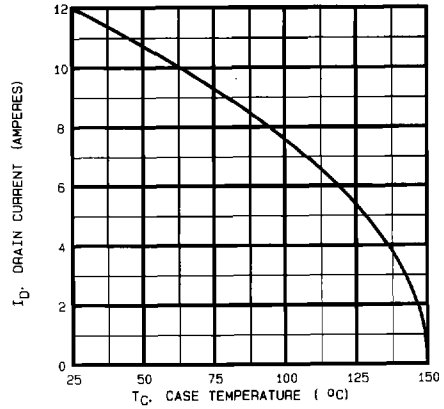

Fig. 9p - Maximum Drain Current Vs. Case Temperature
IRF450

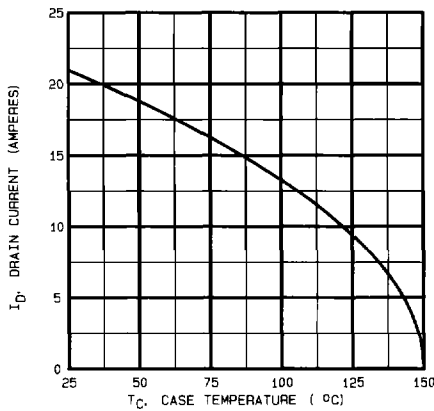

Fig. 9q - Maximum Drain Current Vs. Case Temperature
IRF460

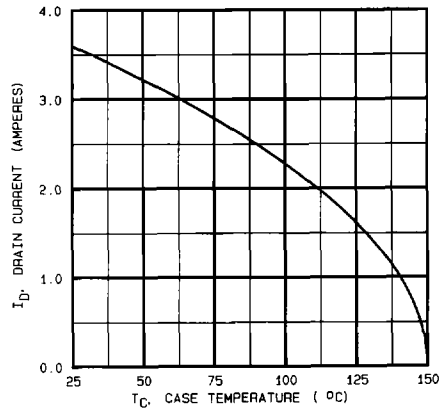

Fig. 9r - Maximum Drain Current Vs. Case Temperature
IRFAC30

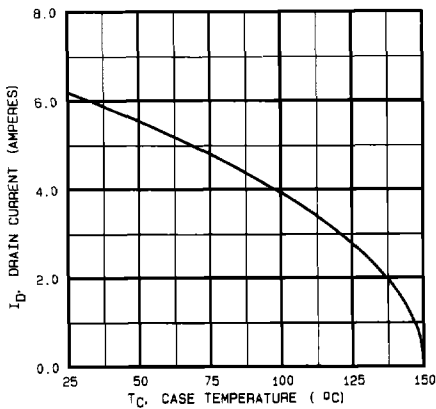

Fig. 9s - Maximum Drain Current Vs. Case Temperature
IRFAC40

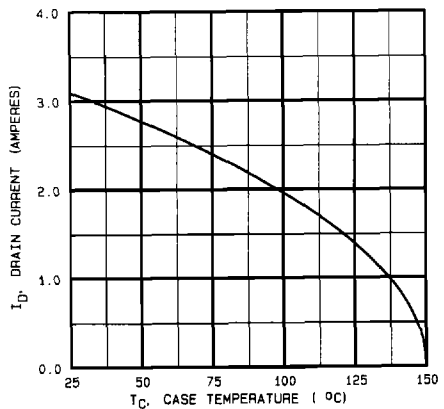

Fig. 9t - Maximum Drain Current Vs. Case Temperature
IRFAE30

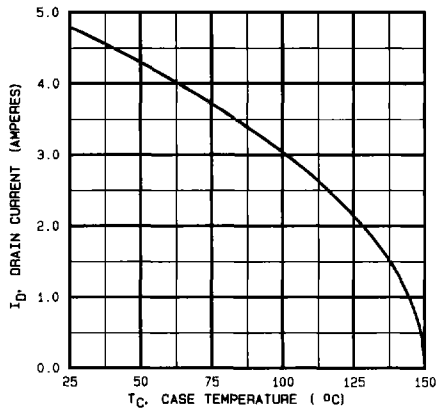

Fig. 9u – Maximum Drain Current Vs. Case Temperature IRFAE40

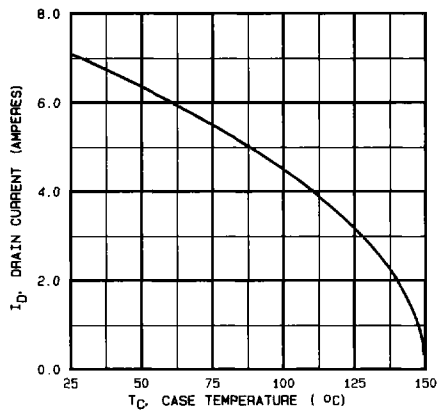

Fig. 9v – Maximum Drain Current Vs. Case Temperature IRFAE50

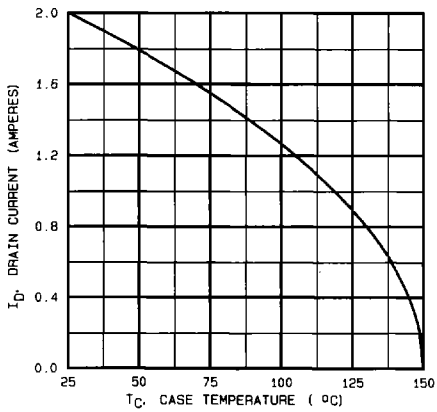

Fig. 9w – Maximum Drain Current Vs. Case Temperature IRFAF30

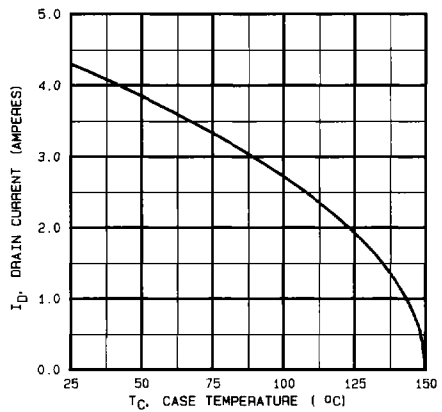

Fig. 9x – Maximum Drain Current Vs. Case Temperature IRFAF40

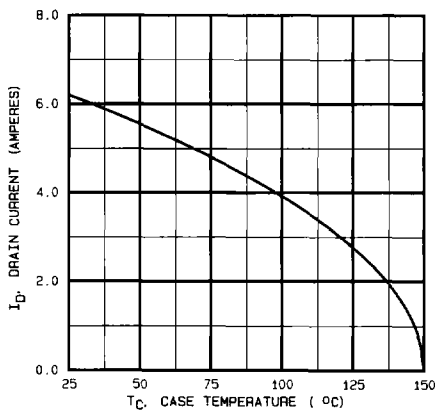

Fig. 9y – Maximum Drain Current Vs. Case Temperature IRFAF50

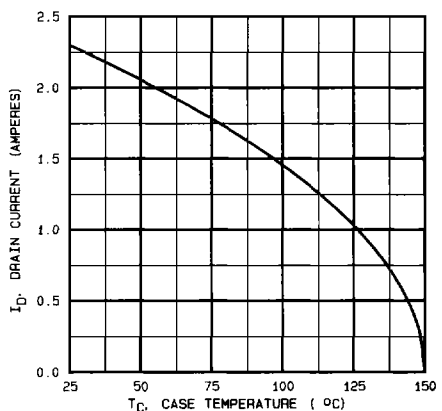

Fig. 9z – Maximum Drain Current Vs. Case Temperature IRFAG30

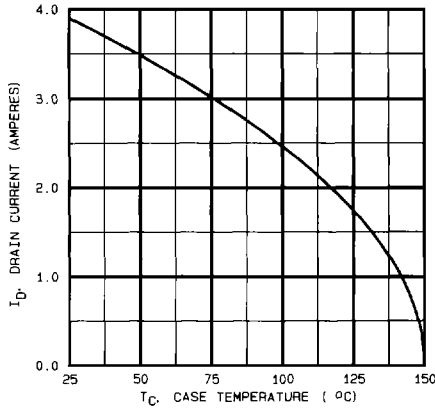

Fig. 9aa – Maximum Drain Current Vs. Case Temperature IRFAG40

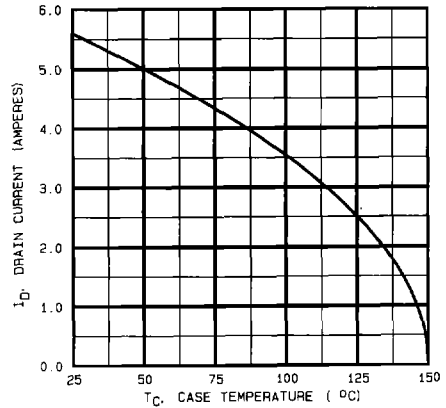

Fig. 9bb – Maximum Drain Current Vs. Case Temperature IRFAG50

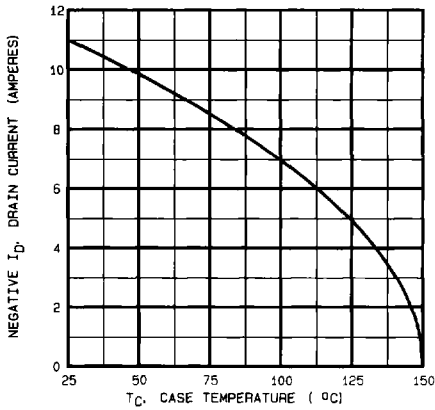

Fig. 9cc – Maximum Drain Current Vs. Case Temperature IRF9130

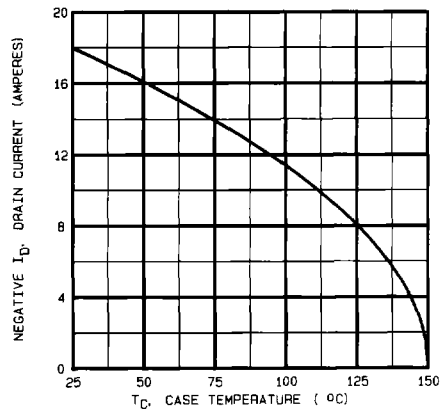

Fig. 9dd – Maximum Drain Current Vs. Case Temperature IRF9140

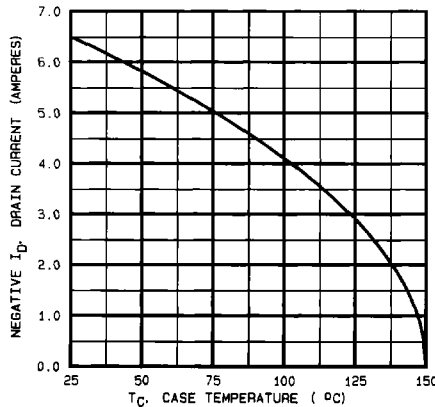

Fig. 9ee – Maximum Drain Current Vs. Case Temperature IRF9230

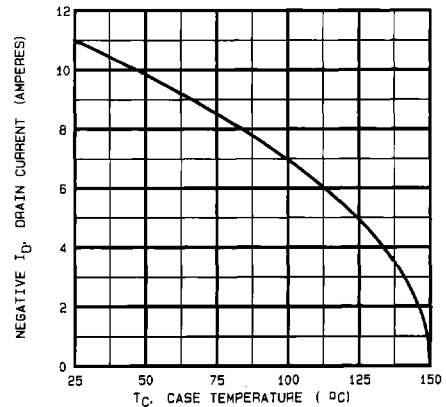

Fig. 9ff – Maximum Drain Current Vs. Case Temperature IRF9240

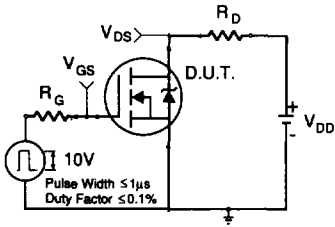

Fig. 10a - Switching Time Test Circuit N-Channel

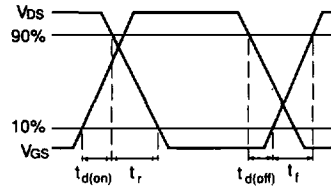

Fig. 10b - Switching Time Waveforms N-Channel

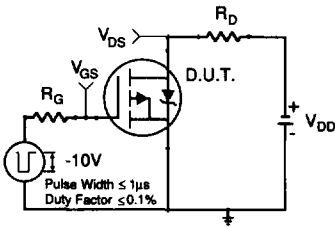

Fig. 10c - Switching Time Test Circuit P-Channel

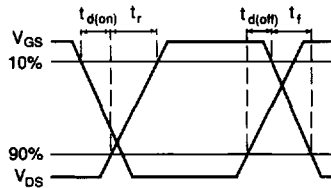

Fig. 10d - Switching Time Waveforms P-Channel



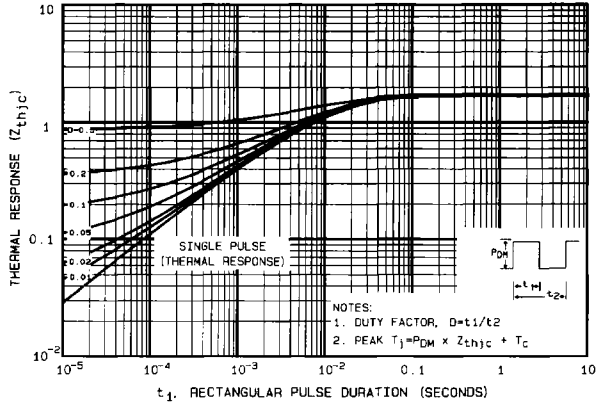

Fig. 11a - Maximum Effective Transient Thermal Impedance, Junction-to-Case Vs. Pulse Duration
IRF034, IRF130, IRF230, IRF330, IRF430, IRFAC30,
IRFAE30, IRFAF30, IRFAG30, IRF9130 & IRF9230

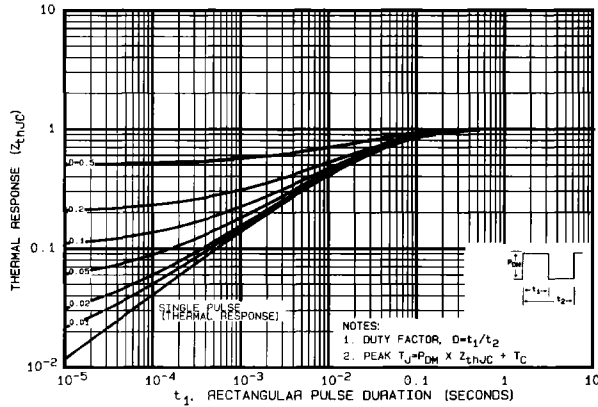

Fig. 11b - Maximum Effective Transient Thermal Impedance, Junction-to-Case Vs. Pulse Duration
IRF044, IRF140, IRF240, IRF340, IRF440, IRFAC40,
IRFAE40, IRFAF40, IRFAG40, IRF9140 & IRF9240

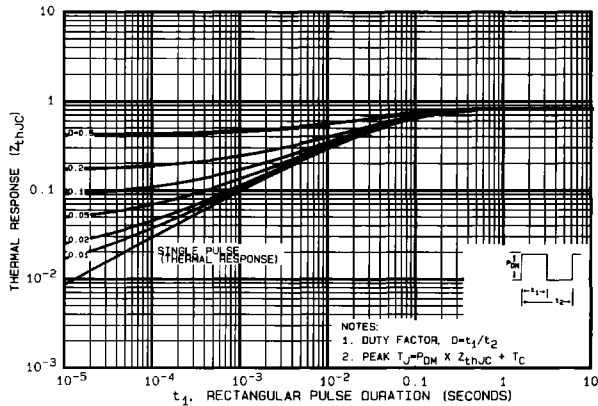

Fig. 11c - Maximum Effective Transient Thermal Impedance, Junction-to-Case Vs. Pulse Duration
IRF054, IRF150, IRF250, IRF350, IRF450, IRFAC50,
IRFAE50, IRFAF50, & IRFAG50

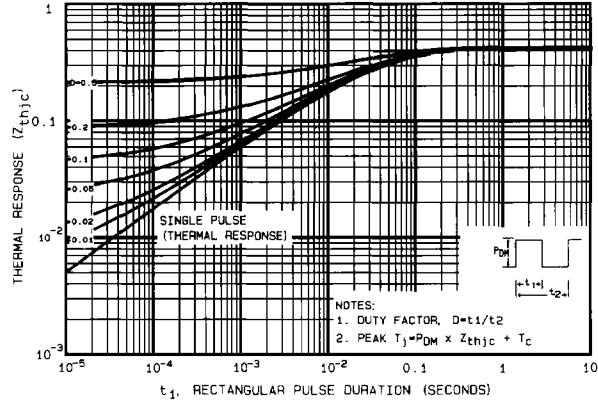

Fig. 11d – Maximum Effective Transient Thermal Impedance, Junction-to-Case Vs. Pulse Duration IRF360 & IRF460

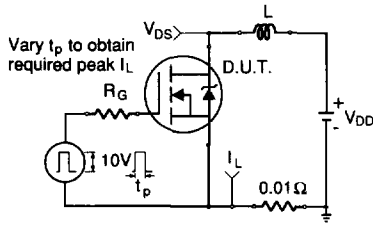

Fig. 12a – Unclamped Inductive Test Circuit N-Channel

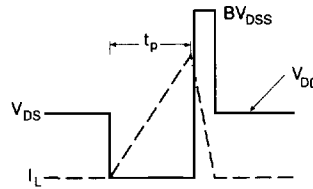

Fig. 12b – Unclamped Inductive Waveforms N-Channel

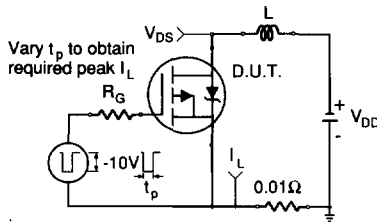

Fig. 12c – Unclamped Inductive Test Circuit P-Channel

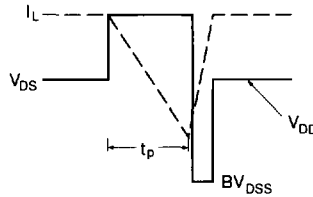

Fig. 12d – Unclamped Inductive Waveforms P-Channel

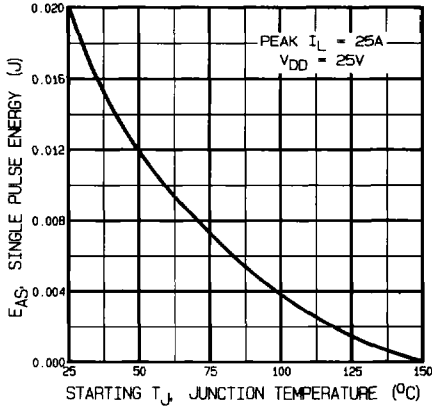

Fig. 13a – Maximum Avalanche Energy Vs. Starting Junction Temperature, IRF034

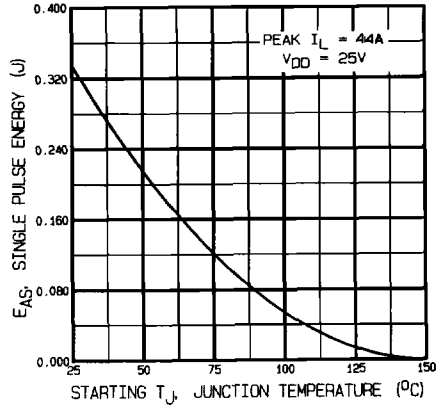

Fig. 13b – Maximum Avalanche Energy Vs. Starting Junction Temperature, IRF044

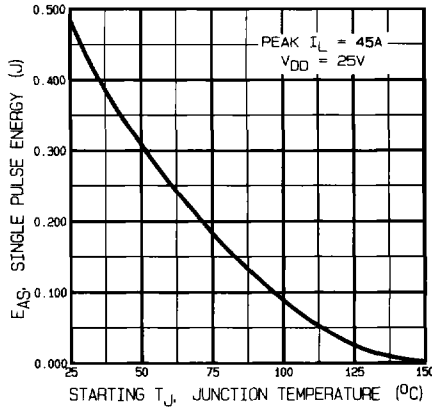

Fig. 13c – Maximum Avalanche Energy Vs. Starting Junction Temperature, IRF054

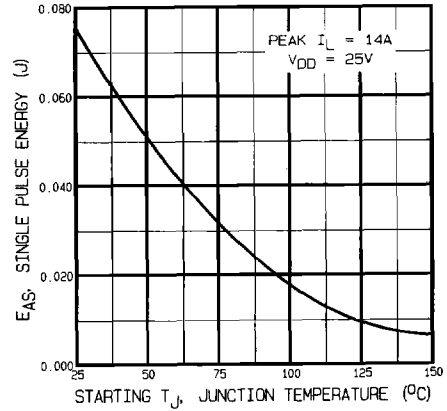

Fig. 13d – Maximum Avalanche Energy Vs. Starting Junction Temperature, IRF130

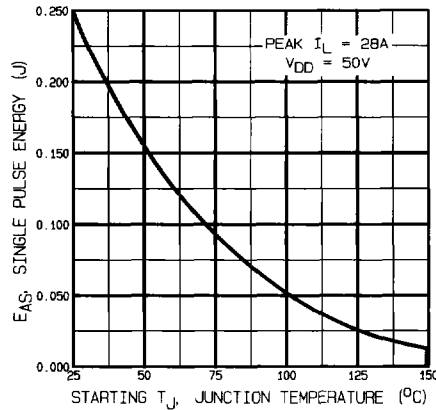

Fig. 13e – Maximum Avalanche Energy Vs. Starting Junction Temperature, IRF140

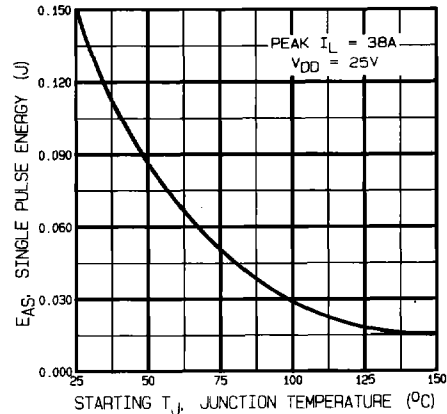

Fig. 13f – Maximum Avalanche Energy Vs. Starting Junction Temperature, IRF150

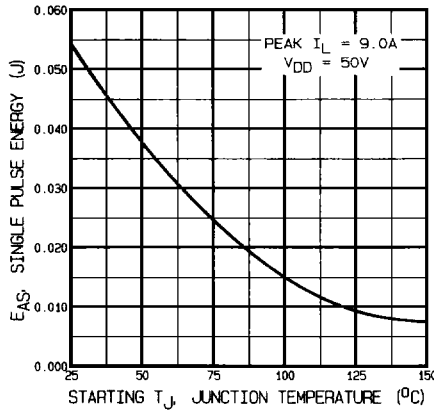

Fig. 13g - Maximum Avalanche Energy Vs. Starting Junction Temperature, IRF230

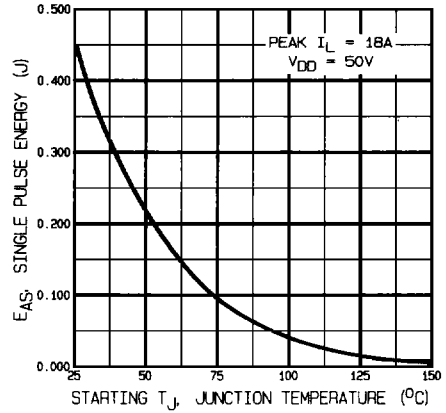

Fig. 13h - Maximum Avalanche Energy Vs. Starting Junction Temperature, IRF240

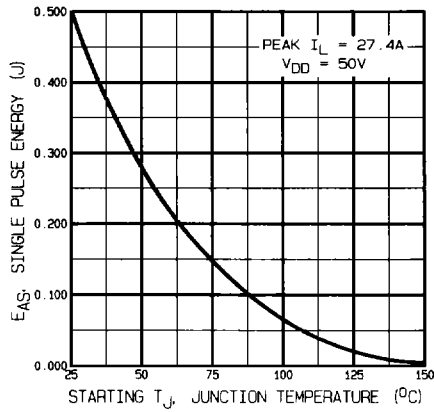

Fig. 13i - Maximum Avalanche Energy Vs. Starting Junction Temperature, IRF250

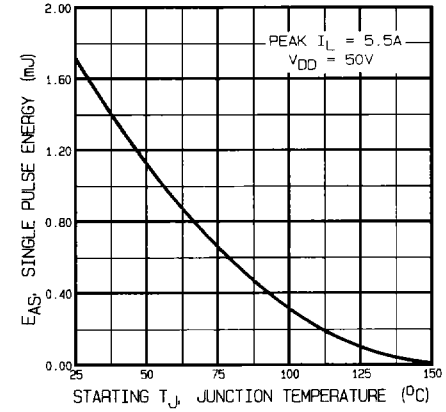

Fig. 13j - Maximum Avalanche Energy Vs. Starting Junction Temperature, IRF330

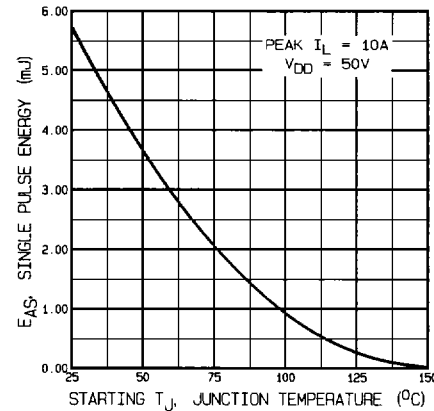

Fig. 13k - Maximum Avalanche Energy Vs. Starting Junction Temperature, IRF340

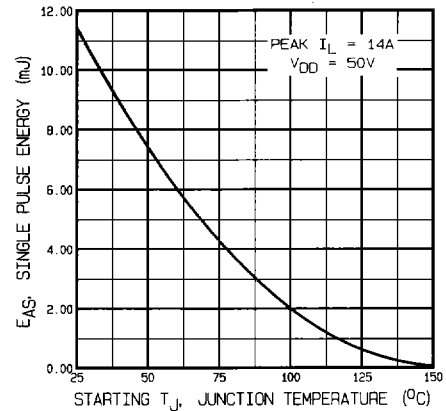

Fig. 13l - Maximum Avalanche Energy Vs. Starting Junction Temperature, IRF350

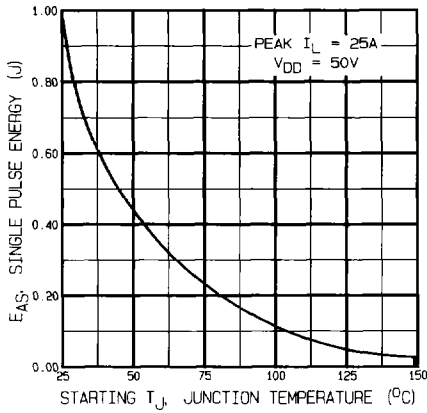

Fig. 13m – Maximum Avalanche Energy Vs. Starting Junction Temperature, IRF360

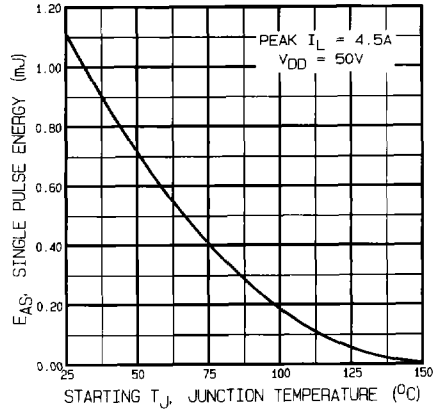

Fig. 13n – Maximum Avalanche Energy Vs. Starting Junction Temperature, IRF430

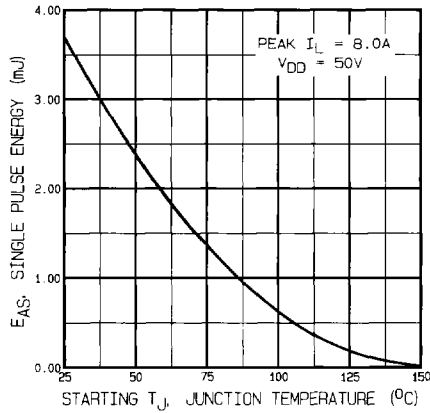

Fig. 13o – Maximum Avalanche Energy Vs. Starting Junction Temperature, IRF440

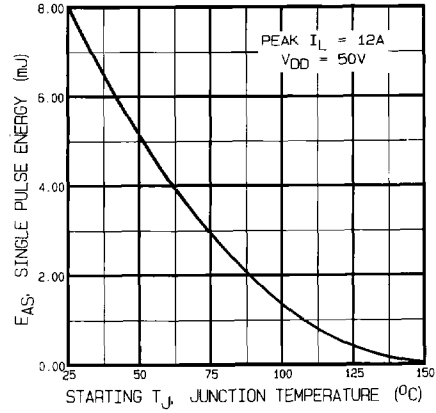

Fig. 13p – Maximum Avalanche Energy Vs. Starting Junction Temperature, IRF450

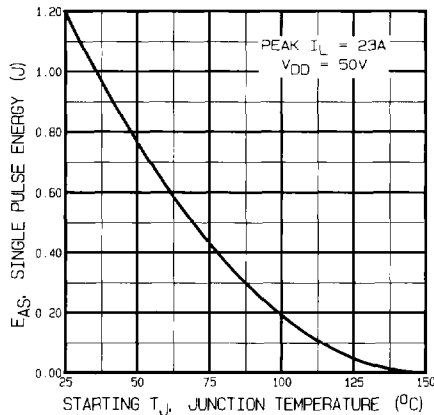

Fig. 13q – Maximum Avalanche Energy Vs. Starting Junction Temperature, IRF460

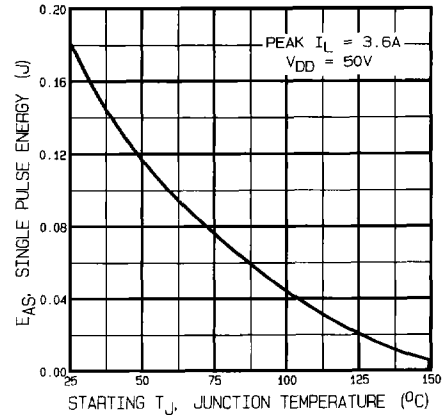

Fig. 13r – Maximum Avalanche Energy Vs. Starting Junction Temperature, IRFAC30

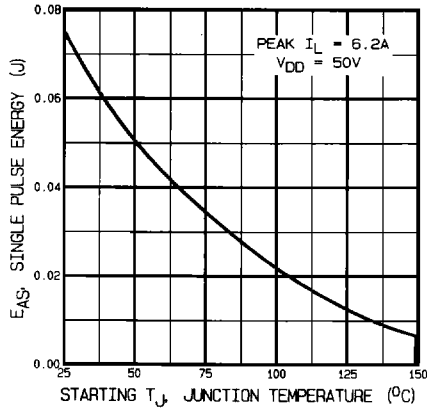

Fig. 13s – Maximum Avalanche Energy Vs. Starting Junction Temperature, IRFAC40

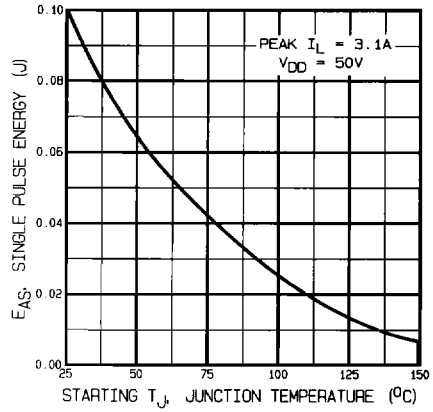

Fig. 13t – Maximum Avalanche Energy Vs. Starting Junction Temperature, IRFAE30

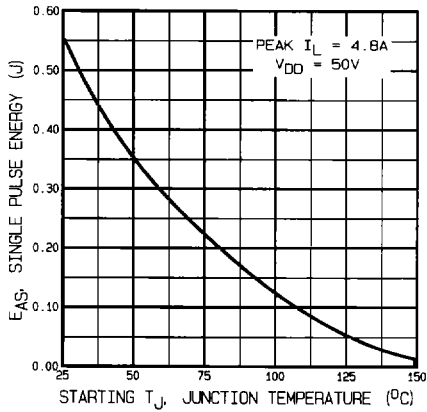

Fig. 13u – Maximum Avalanche Energy Vs. Starting Junction Temperature, IRFAE40

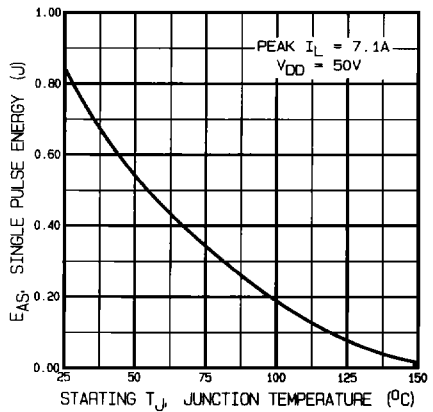

Fig. 13v – Maximum Avalanche Energy Vs. Starting Junction Temperature, IRFAE50

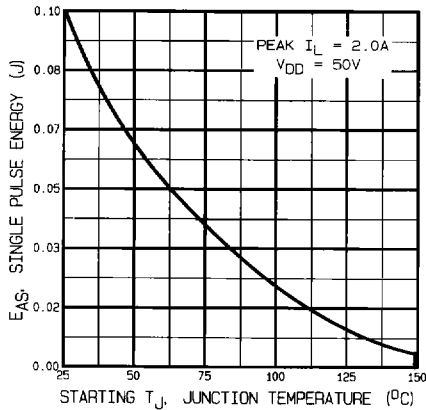

Fig. 13w – Maximum Avalanche Energy Vs. Starting Junction Temperature, IRFAF30

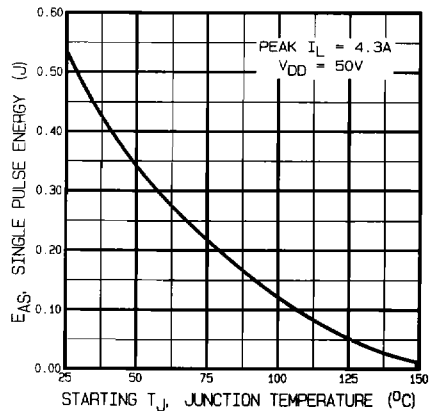

Fig. 13x – Maximum Avalanche Energy Vs. Starting Junction Temperature, IRFAF40

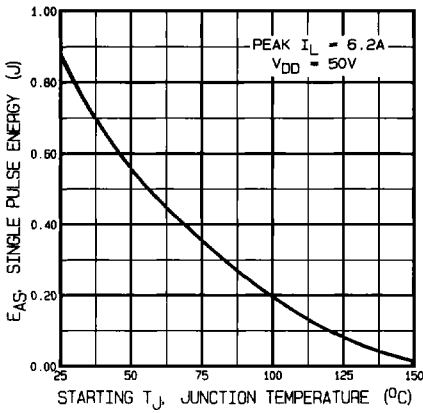

Fig. 13y – Maximum Avalanche Energy Vs. Starting Junction Temperature, IRFAF50

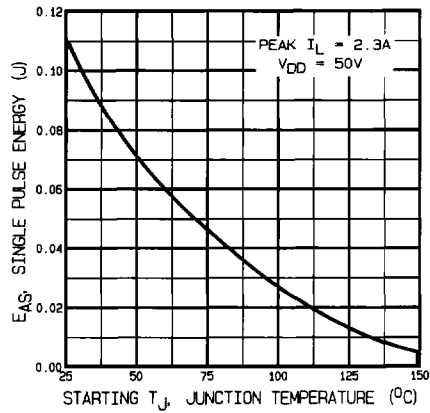

Fig. 13z – Maximum Avalanche Energy Vs. Starting Junction Temperature, IRFAG30

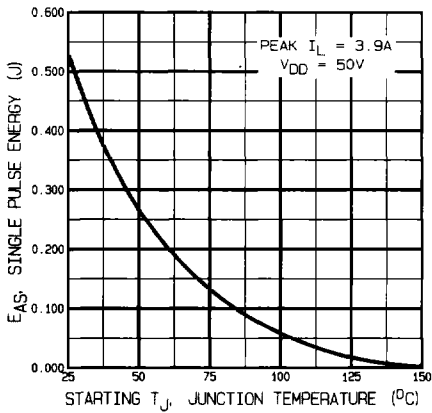

Fig. 13aa – Maximum Avalanche Energy Vs. Starting Junction Temperature, IRFAG40

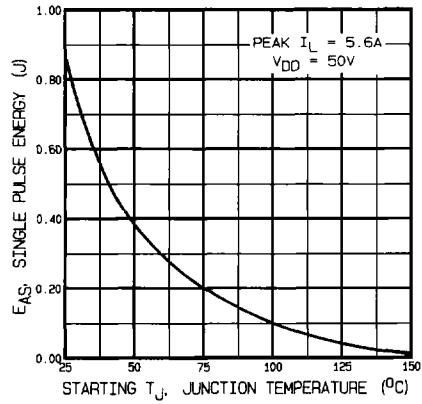

Fig. 13bb – Maximum Avalanche Energy Vs. Starting Junction Temperature, IRFAG50

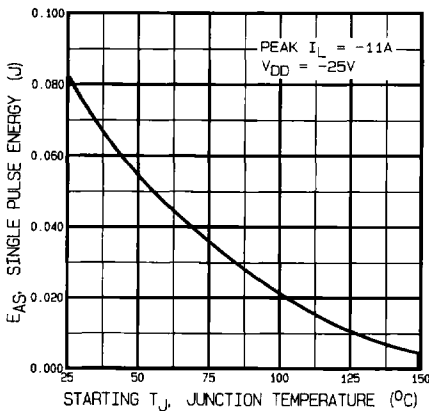

Fig. 13cc – Maximum Avalanche Energy Vs. Starting Junction Temperature, IRF9130

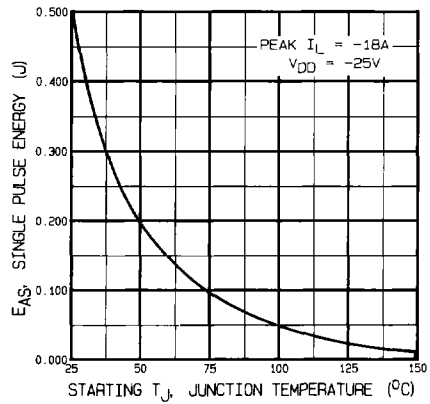

Fig. 13dd – Maximum Avalanche Energy Vs. Starting Junction Temperature, IRF9140

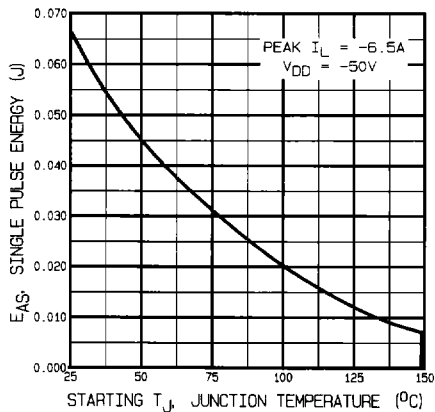

Fig. 13ee - Maximum Avalanche Energy Vs. Starting Junction Temperature, IRF9230

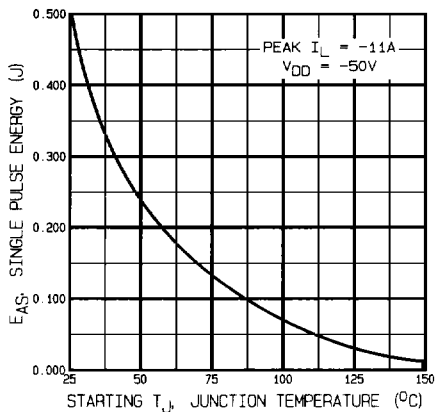

Fig. 13ff - Maximum Avalanche Energy Vs. Starting Junction Temperature, IRF9240

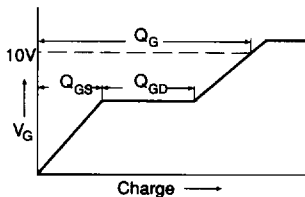

Fig. 14a - Basic Gate Charge Waveform N-Channel

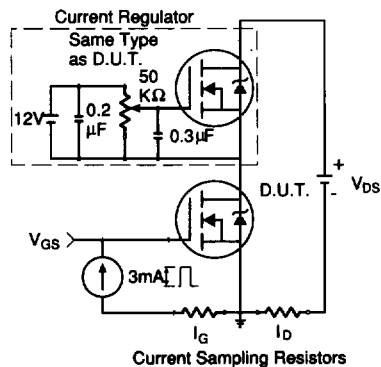

Fig. 14b - Basic Gate Charge Waveform N-Channel

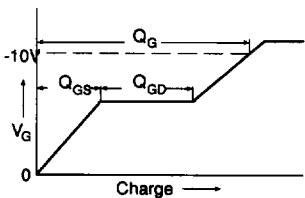

Fig. 14c - Gate Charge Test Circuit P-Channel

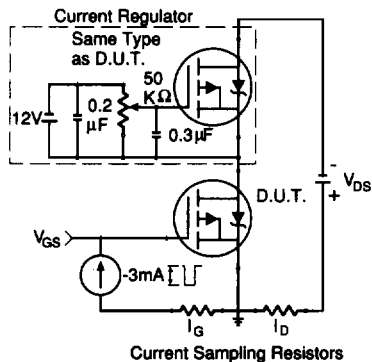

Fig. 14d - Basic Gate Charge Waveform P-Channel

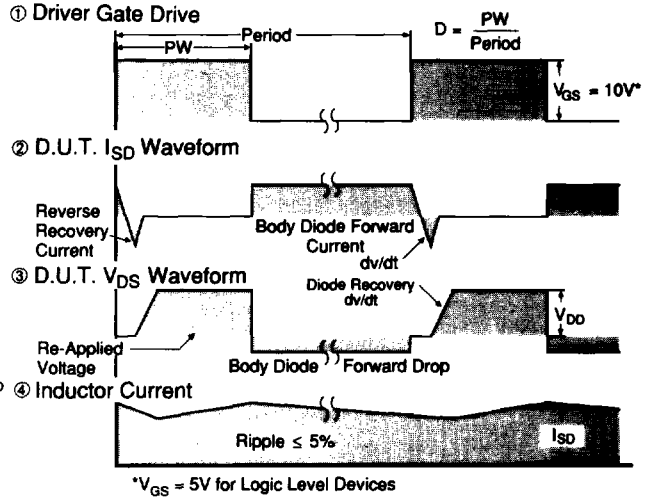
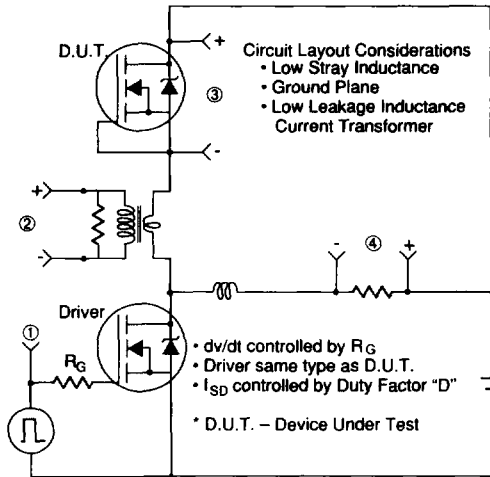

Fig. 15a - Peak Diode Recovery dv/dt Test Circuit N-Channel

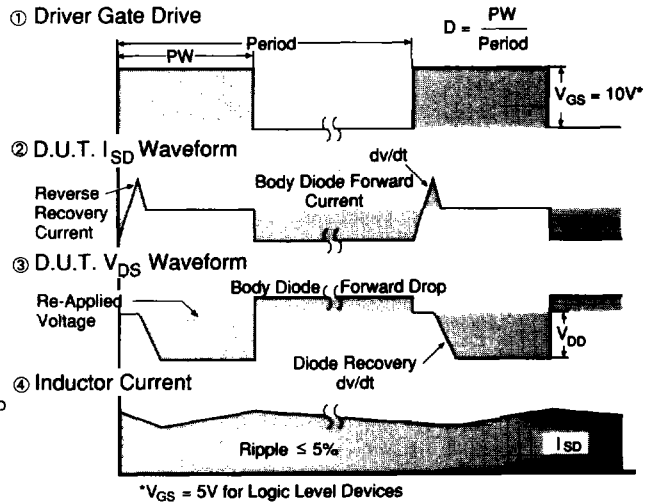
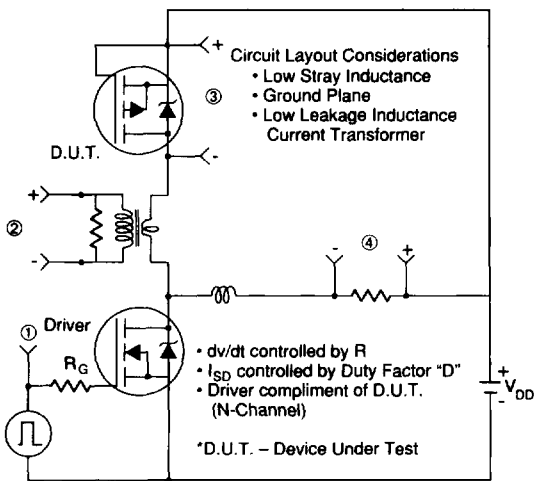

Fig. 15b - Peak Diode Recovery dv/dt Test Circuit P-Channel