



AO4600

Complementary Enhancement Mode Field Effect Transistor

General Description

The AO4600 uses advanced trench technology to provide excellent $R_{DS(ON)}$ and low gate charge. The complementary MOSFETs form a high-speed power inverter, suitable for a multitude of applications. Standard Product AO4600 is Pb-free (meets ROHS & Sony 259 specifications). AO4600L is a Green Product ordering option. AO4600 and AO4600L are electrically identical.

Features

n-channel	p-channel
$V_{DS} (V) = 30V$	-30V
$I_D = 6.9A (V_{GS} = 10V)$	-5A ($V_{GS} = -10V$)
$R_{DS(ON)}$	
< 27m Ω	< 49m Ω ($V_{GS} = -10V$)
< 32m Ω	< 64m Ω ($V_{GS} = -4.5V$)
< 50m Ω	< 120m Ω ($V_{GS} = -2.5V$)

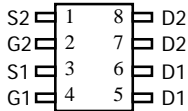

SOIC-8

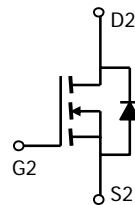

n-channel

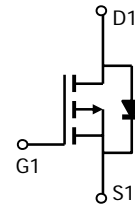

p-channel

Absolute Maximum Ratings $T_A=25^\circ C$ unless otherwise noted

Parameter	Symbol	Max n-channel	Max p-channel	Units
Drain-Source Voltage	V_{DS}	30	-30	V
Gate-Source Voltage	V_{GS}	± 12	± 12	V
Continuous Drain Current ^A	$T_A=25^\circ C$	6.9	-5	A
	$T_A=70^\circ C$	5.8	-4.2	
Pulsed Drain Current ^B	I_{DM}	40	-30	
Power Dissipation	$T_A=25^\circ C$	2	2	W
	$T_A=70^\circ C$	1.44	1.44	
Junction and Storage Temperature Range	T_J, T_{STG}	-55 to 150	-55 to 150	$^\circ C$

Thermal Characteristics: n-channel and p-channel

Parameter	Symbol	Typ	Max	Units
Maximum Junction-to-Ambient ^A	$R_{\theta JA}$	48	62.5	$^\circ C/W$
Maximum Junction-to-Ambient ^A		Steady-State	74	110
Maximum Junction-to-Lead ^C	$R_{\theta JL}$	35	40	$^\circ C/W$

n-channel MOSFET Electrical Characteristics (T_J=25°C unless otherwise noted)

Symbol	Parameter	Conditions	Min	Typ	Max	Units
STATIC PARAMETERS						
BV _{DSS}	Drain-Source Breakdown Voltage	I _D =250μA, V _{GS} =0V	30			V
I _{DSS}	Zero Gate Voltage Drain Current	V _{DS} =24V, V _{GS} =0V T _J =55°C			1 5	μA
I _{GSS}	Gate-Body leakage current	V _{DS} =0V, V _{GS} =±12V			100	nA
V _{GS(th)}	Gate Threshold Voltage	V _{DS} =V _{GS} I _D =250μA	0.7	1	1.4	V
I _{D(ON)}	On state drain current	V _{GS} =4.5V, V _{DS} =5V	25			A
R _{DS(ON)}	Static Drain-Source On-Resistance	V _{GS} =10V, I _D =6.9A T _J =125°C		22.6	27	mΩ
		V _{GS} =4.5V, I _D =6.0A		27	32	
		V _{GS} =2.5V, I _D =5A		42	50	mΩ
g _{FS}	Forward Transconductance	V _{DS} =5V, I _D =5A	12	16		S
V _{SD}	Diode Forward Voltage	I _S =1A		0.71	1	V
I _S	Maximum Body-Diode Continuous Current				3	A
DYNAMIC PARAMETERS						
C _{iss}	Input Capacitance	V _{GS} =0V, V _{DS} =15V, f=1MHz		858	1050	pF
C _{oss}	Output Capacitance			110		pF
C _{rss}	Reverse Transfer Capacitance			80		pF
R _g	Gate resistance	V _{GS} =0V, V _{DS} =0V, f=1MHz		1.4	2	Ω
SWITCHING PARAMETERS						
Q _g	Total Gate Charge	V _{GS} =4.5V, V _{DS} =15V, I _D =6.9A		9.6	12	nC
Q _{gs}	Gate Source Charge			1.65		nC
Q _{gd}	Gate Drain Charge			3		nC
t _{D(on)}	Turn-On Delay Time	V _{GS} =10V, V _{DS} =15V, R _L =2.2Ω, R _{GEN} =6Ω		5.7		ns
t _r	Turn-On Rise Time			13		ns
t _{D(off)}	Turn-Off Delay Time			37		ns
t _f	Turn-Off Fall Time			4.2		ns
t _{rr}	Body Diode Reverse Recovery time	I _F =5A, dI/dt=100A/μs		15.5	20	ns
Q _{rr}	Body Diode Reverse Recovery charge	I _F =5A, dI/dt=100A/μs		7.9		nC

A: The value of R_{θJA} is measured with the device mounted on 1in² FR-4 board with 2oz. Copper, in a still air environment with T_A=25°C. The value in any given application depends on the user's specific board design. The current rating is based on the t ≤ 10s thermal resistance rating.

B: Repetitive rating, pulse width limited by junction temperature.

C: The R_{θJA} is the sum of the thermal impedance from junction to lead R_{θJL} and lead to ambient.

D: The static characteristics in Figures 1 to 6 are obtained using 80μs pulses, duty cycle 0.5% max.

E: These tests are performed with the device mounted on 1 in² FR-4 board with 2oz. Copper, in a still air environment with T_A=25°C. The SOA curve provides a single pulse rating.

THIS PRODUCT HAS BEEN DESIGNED AND QUALIFIED FOR THE CONSUMER MARKET. APPLICATIONS OR USES AS CRITICAL COMPONENTS IN LIFE SUPPORT DEVICES OR SYSTEMS ARE NOT AUTHORIZED. AOS DOES NOT ASSUME ANY LIABILITY ARISING OUT OF SUCH APPLICATIONS OR USES OF ITS PRODUCTS. AOS RESERVES THE RIGHT TO IMPROVE PRODUCT DESIGN, FUNCTIONS AND RELIABILITY WITHOUT NOTICE

TYPICAL N-CHANNEL ELECTRICAL AND THERMAL CHARACTERISTICS

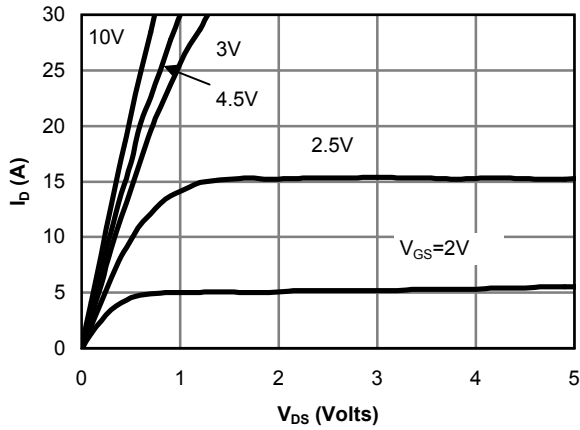

Fig 1: On-Region Characteristics

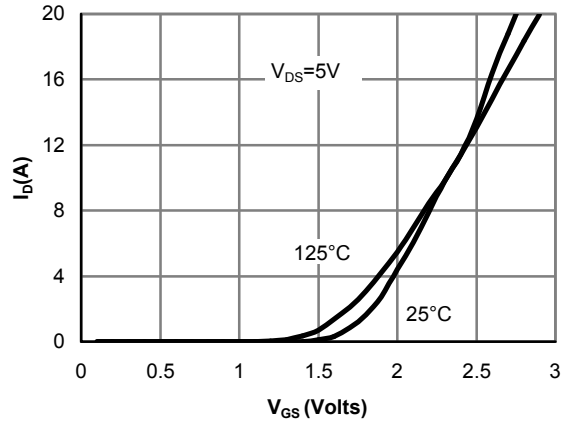

Figure 2: Transfer Characteristics

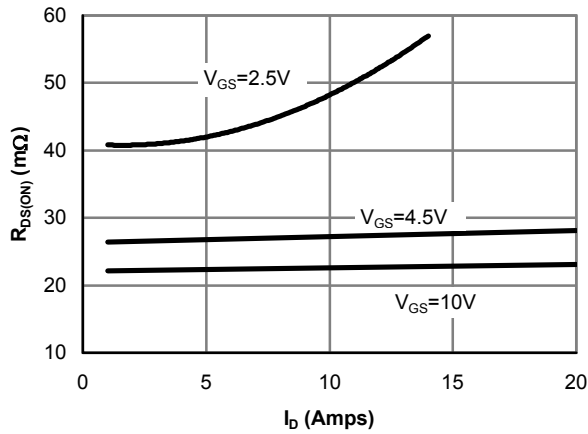

Figure 3: On-Resistance vs. Drain Current and Gate Voltage

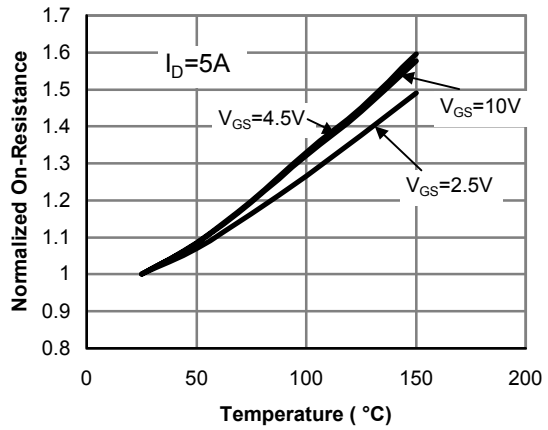

Figure 4: On-Resistance vs. Junction Temperature

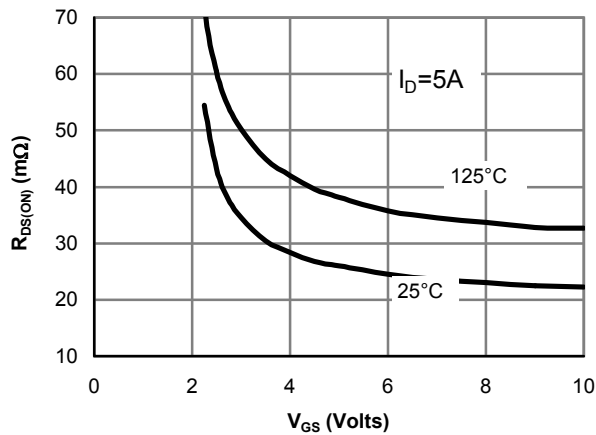

Figure 5: On-Resistance vs. Gate-Source Voltage

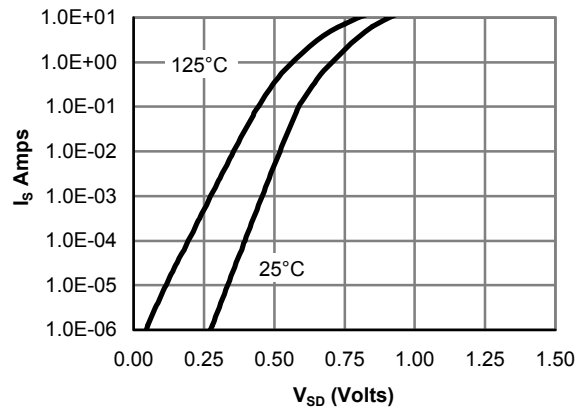

Figure 6: Body diode characteristics

TYPICAL N-CHANNEL ELECTRICAL AND THERMAL CHARACTERISTICS

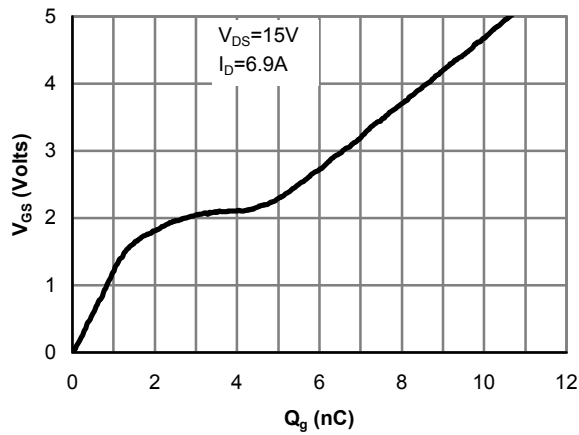

Figure 7: Gate-Charge characteristics

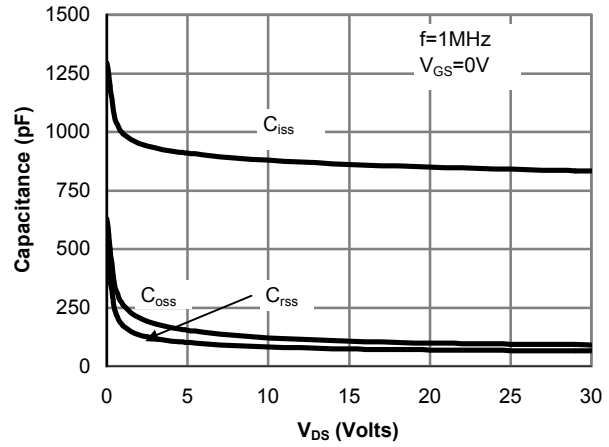

Figure 8: Capacitance Characteristics

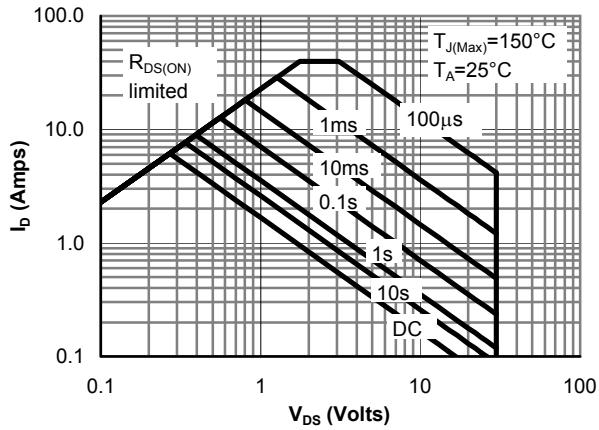

Figure 9: Maximum Forward Biased Safe Operating Area (Note E)

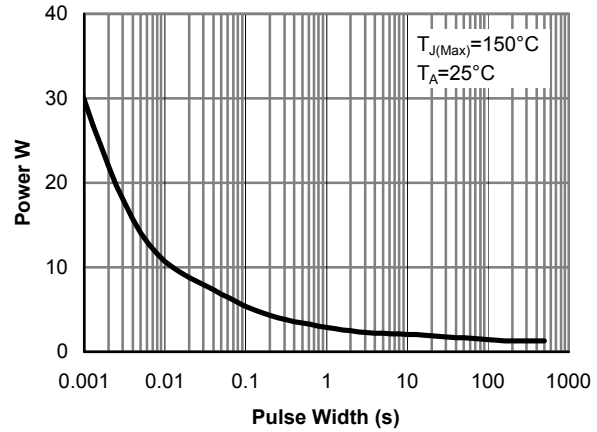

Figure 10: Single Pulse Power Rating Junction-to-Ambient (Note E)

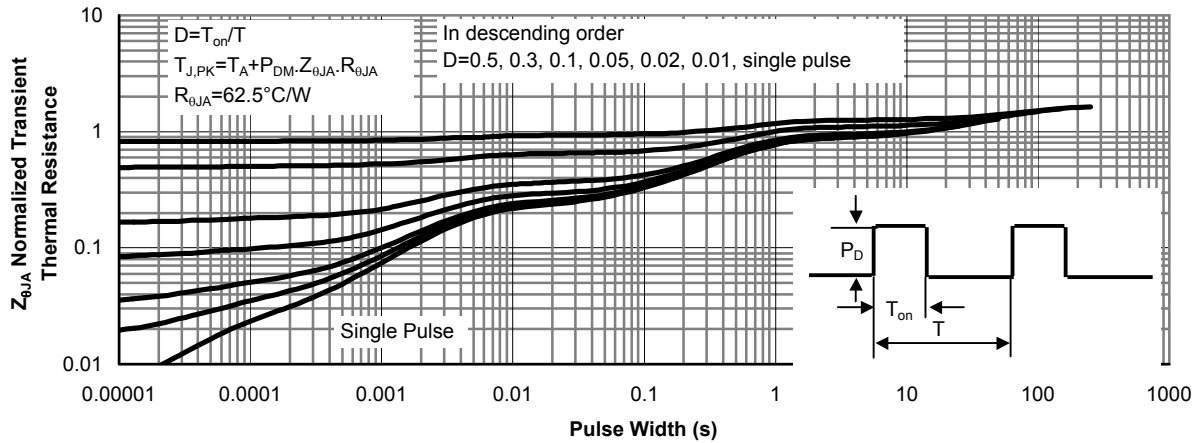

Figure 11: Normalized Maximum Transient Thermal Impedance

p-channel MOSFET Electrical Characteristics ($T_J=25^\circ\text{C}$ unless otherwise noted)

Symbol	Parameter	Conditions	Min	Typ	Max	Units
STATIC PARAMETERS						
BV_{DSS}	Drain-Source Breakdown Voltage	$I_D=-250\mu\text{A}$, $V_{GS}=0\text{V}$	-30			V
I_{DSS}	Zero Gate Voltage Drain Current	$V_{DS}=-24\text{V}$, $V_{GS}=0\text{V}$ $T_J=55^\circ\text{C}$			-1 -5	μA
I_{GSS}	Gate-Body leakage current	$V_{DS}=0\text{V}$, $V_{GS}=\pm 12\text{V}$			± 100	nA
$V_{GS(th)}$	Gate Threshold Voltage	$V_{DS}=V_{GS}$, $I_D=-250\mu\text{A}$	-0.7	-1	-1.4	V
$I_{D(ON)}$	On state drain current	$V_{GS}=-4.5\text{V}$, $V_{DS}=-5\text{V}$	-25			A
$R_{DS(ON)}$	Static Drain-Source On-Resistance	$V_{GS}=-10\text{V}$, $I_D=-5\text{A}$ $T_J=125^\circ\text{C}$		42.5	49	$\text{m}\Omega$
		$V_{GS}=-4.5\text{V}$, $I_D=-4\text{A}$		54	64	$\text{m}\Omega$
		$V_{GS}=-2.5\text{V}$, $I_D=-1\text{A}$		80	120	$\text{m}\Omega$
g_{FS}	Forward Transconductance	$V_{DS}=-5\text{V}$, $I_D=-5\text{A}$	7	11		S
V_{SD}	Diode Forward Voltage	$I_S=-1\text{A}$, $V_{GS}=0\text{V}$		-0.75	-1	V
I_S	Maximum Body-Diode Continuous Current				-3	A
DYNAMIC PARAMETERS						
C_{iss}	Input Capacitance	$V_{GS}=0\text{V}$, $V_{DS}=-15\text{V}$, $f=1\text{MHz}$		952	1200	pF
C_{oss}	Output Capacitance			103		pF
C_{riss}	Reverse Transfer Capacitance			77		pF
R_g	Gate resistance	$V_{GS}=0\text{V}$, $V_{DS}=0\text{V}$, $f=1\text{MHz}$		5.9	30	Ω
SWITCHING PARAMETERS						
Q_g	Total Gate Charge	$V_{GS}=-4.5\text{V}$, $V_{DS}=-15\text{V}$, $I_D=-5\text{A}$		9.5	12	nC
Q_{gs}	Gate Source Charge			2		nC
Q_{gd}	Gate Drain Charge			3.1		nC
$t_{D(on)}$	Turn-On Delay Time	$V_{GS}=-10\text{V}$, $V_{DS}=-15\text{V}$, $R_L=3\Omega$, $R_{GEN}=6\Omega$		12		ns
t_r	Turn-On Rise Time			4		ns
$t_{D(off)}$	Turn-Off Delay Time			37		ns
t_f	Turn-Off Fall Time			12		ns
t_{rr}	Body Diode Reverse Recovery Time	$I_F=-5\text{A}$, $dI/dt=100\text{A}/\mu\text{s}$		21	26	ns
Q_{rr}	Body Diode Reverse Recovery Charge	$I_F=-5\text{A}$, $dI/dt=100\text{A}/\mu\text{s}$		13		nC

A: The value of $R_{\theta JA}$ is measured with the device mounted on 1in² FR-4 board with 2oz. Copper, in a still air environment with $T_A=25^\circ\text{C}$. The value in any given application depends on the user's specific board design. The current rating is based on the $t \leq 10\text{s}$ thermal resistance rating.

B: Repetitive rating, pulse width limited by junction temperature.

C: The $R_{\theta JA}$ is the sum of the thermal impedance from junction to lead $R_{\theta JL}$ and lead to ambient.

D: The static characteristics in Figures 1 to 6, 12, 14 are obtained using 80 μs pulses, duty cycle 0.5% max.

E: These tests are performed with the device mounted on 1 in² FR-4 board with 2oz. Copper, in a still air environment with $T_A=25^\circ\text{C}$. The SOA curve provides a single pulse rating.

Rev 4 : Sept 2005

THIS PRODUCT HAS BEEN DESIGNED AND QUALIFIED FOR THE CONSUMER MARKET. APPLICATIONS OR USES AS CRITICAL COMPONENTS IN LIFE SUPPORT DEVICES OR SYSTEMS ARE NOT AUTHORIZED. AOS DOES NOT ASSUME ANY LIABILITY ARISING OUT OF SUCH APPLICATIONS OR USES OF ITS PRODUCTS. AOS RESERVES THE RIGHT TO IMPROVE PRODUCT DESIGN, FUNCTIONS AND RELIABILITY WITHOUT NOTICE.

TYPICAL P-CHANNEL ELECTRICAL AND THERMAL CHARACTERISTICS

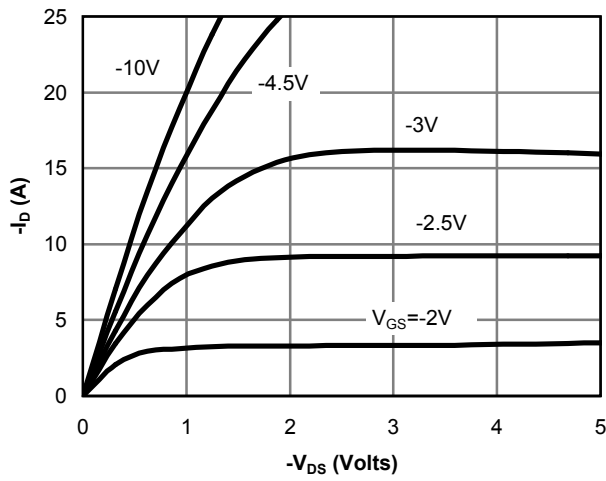

Fig 1: On-Region Characteristics

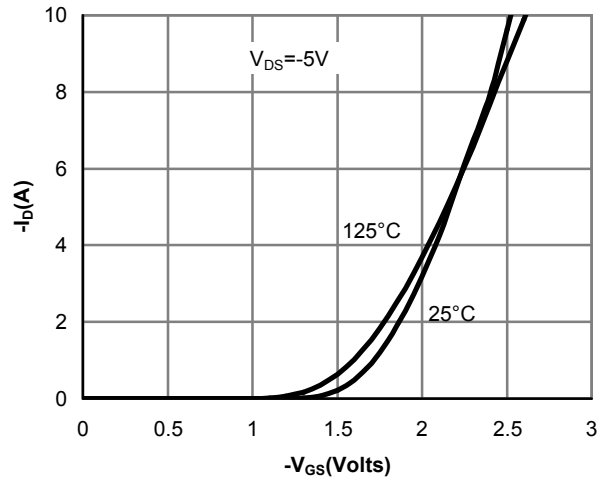

Figure 2: Transfer Characteristics

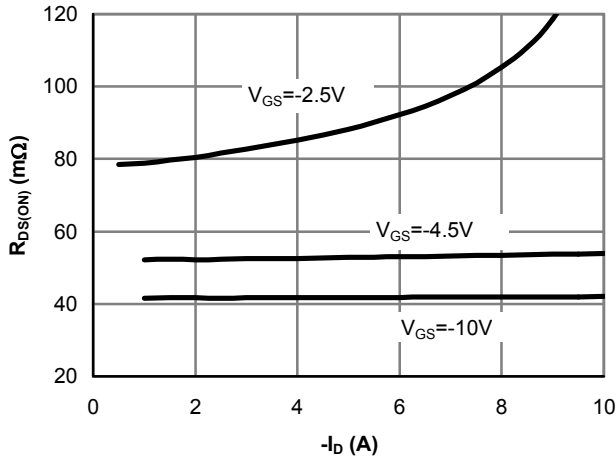

Figure 3: On-Resistance vs. Drain Current and Gate Voltage

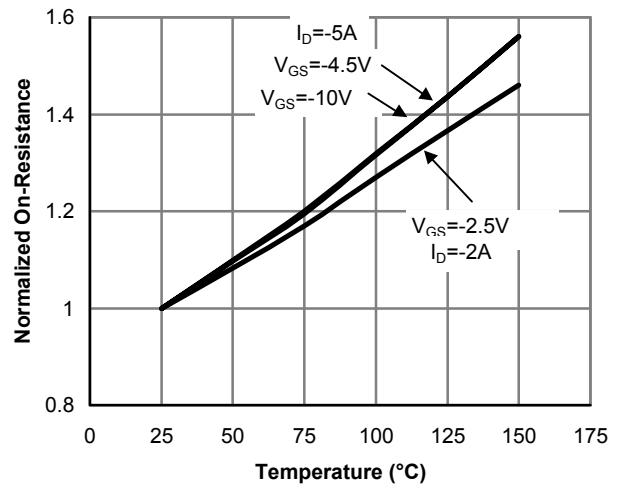

Figure 4: On-Resistance vs. Junction Temperature

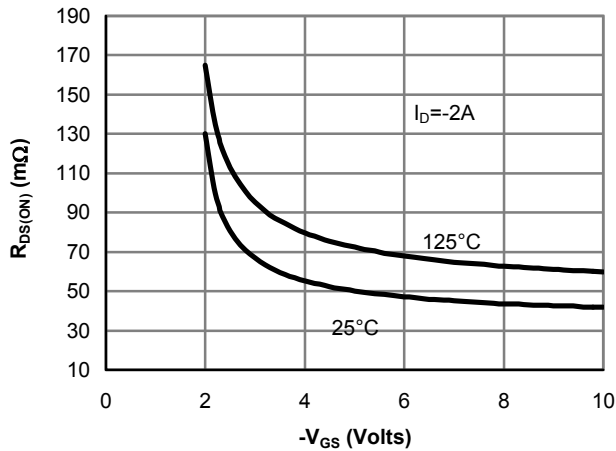

Figure 5: On-Resistance vs. Gate-Source Voltage

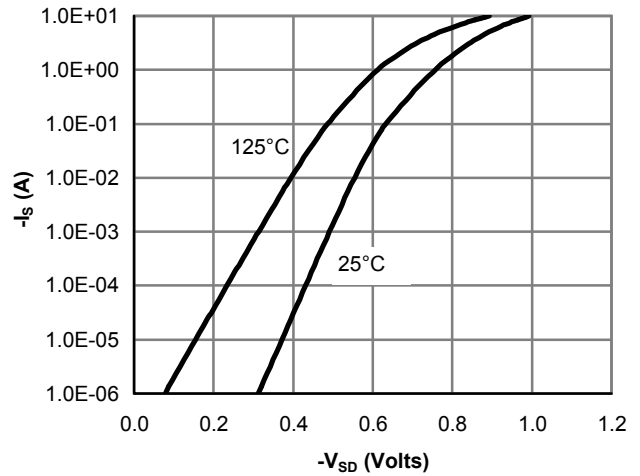

Figure 6: Body-Diode Characteristics

TYPICAL P-CHANNEL ELECTRICAL AND THERMAL CHARACTERISTICS

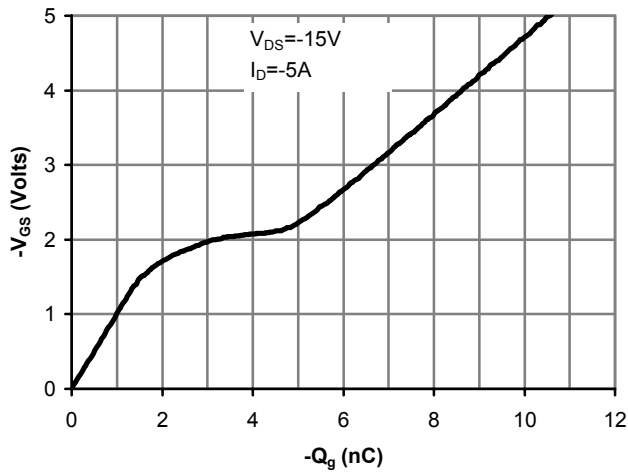

Figure 7: Gate-Charge Characteristics

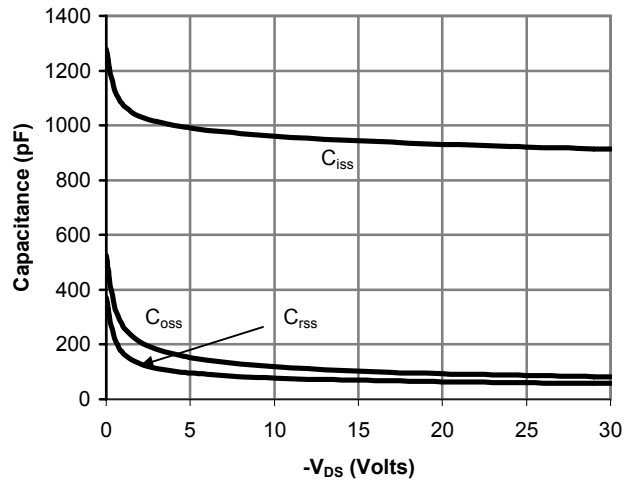

Figure 8: Capacitance Characteristics

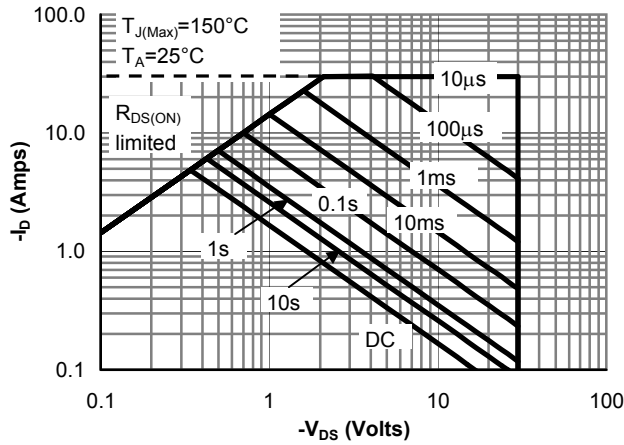

Figure 9: Maximum Forward Biased Safe Operating Area (Note E)

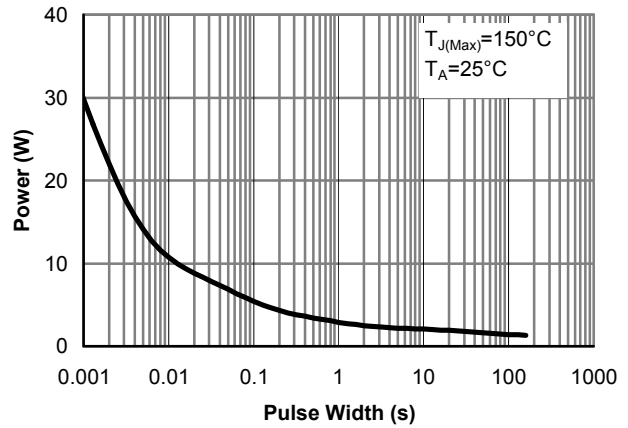

Figure 10: Single Pulse Power Rating Junction-to-Ambient (Note E)

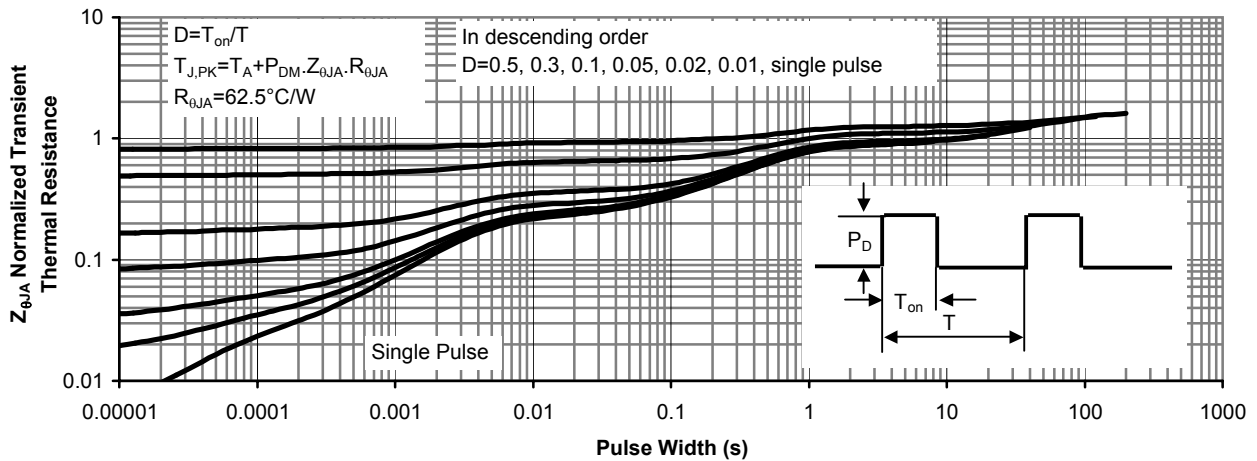

Figure 11: Normalized Maximum Transient Thermal Impedance



ALPHA & OMEGA
SEMICONDUCTOR, LTD.

Document No.	PD-00165
Version	rev C
Title	AO4600 Marking Description

SO-8 PACKAGE MARKING DESCRIPTION

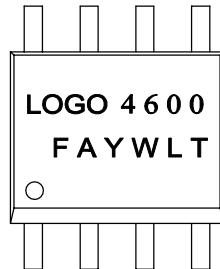

Standard product

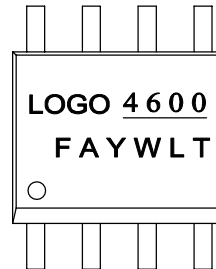

Green product

NOTE:

LOGO - AOS LOGO
4600 - PART NUMBER CODE.
F&A - FOUNDRY AND ASSEMBLY LOCATION
Y - YEAR CODE
W - WEEK CODE.
L T - ASSEMBLY LOT CODE

PART NO.	DESCRIPTION	CODE
AO4600	Standard product	4600
AO4600L	Green product	<u>4600</u>



SO-8L PACKAGE OUTLINE

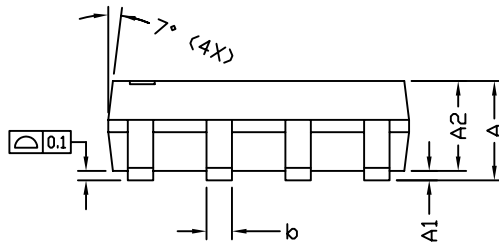
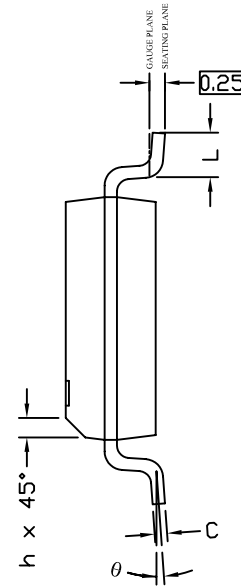
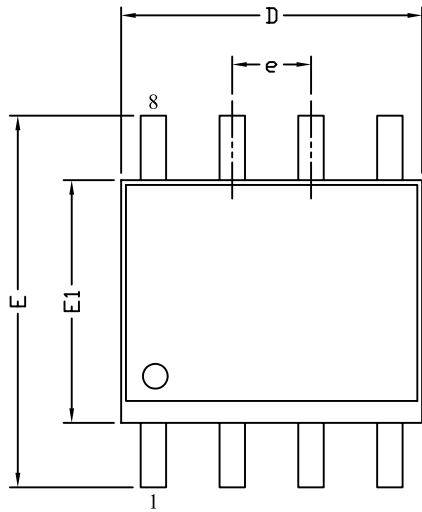

RECOMMENDED LAND PATTERN

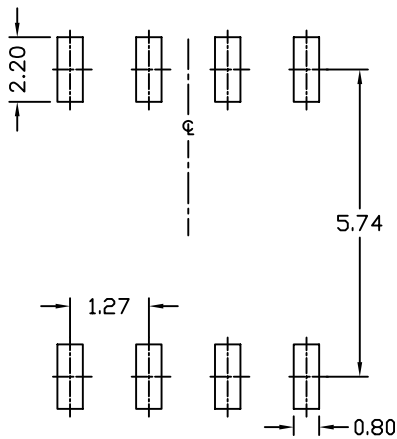

SYMBOLS	DIMENSIONS IN MILLIMETERS			DIMENSIONS IN INCHES		
	MIN	NOM	MAX	MIN	NOM	MAX
A	1.35	1.65	1.75	0.053	0.065	0.069
A1	0.10	---	0.25	0.004	---	0.010
A2	1.25	1.50	1.65	0.049	0.059	0.065
b	0.31	---	0.51	0.012	---	0.020
c	0.17	---	0.25	0.007	---	0.010
D	4.80	4.90	5.00	0.189	0.193	0.197
E1	3.80	3.90	4.00	0.150	0.154	0.157
e	1.27 BSC			0.050 BSC		
E	5.80	6.00	6.20	0.228	0.236	0.244
h	0.25	---	0.50	0.010	---	0.020
L	0.40	---	1.27	0.016	---	0.050
θ	0°	---	8°	0°	---	8°

UNIT: mm

NOTE

- ALL DIMENSIONS ARE IN MILLIMETERS.
- DIMENSIONS ARE INCLUSIVE OF PLATING.
- PACKAGE BODY SIZES EXCLUDE MOLD FLASH AND GATE BURRS.
MOLD FLASH AT THE NON-LEAD SIDES SHOULD BE LESS THAN 6 MILS.
- DIMENSION L IS MEASURED IN GAUGE PLANE.
- CONTROLLING DIMENSION IS MILLIMETER.
CONVERTED INCH DIMENSIONS ARE NOT NECESSARILY EXACT.



ALPHA & OMEGA
SEMICONDUCTOR, LTD.

SO-8 Tape and Reel Data

SO-8 Carrier Tape

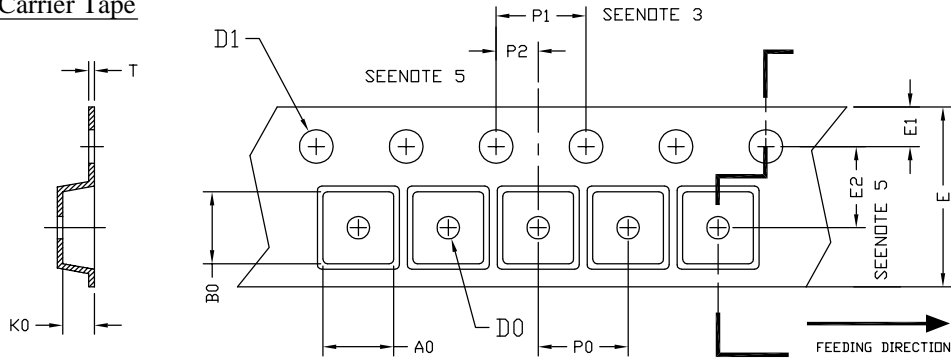

UNIT: MM

PACKAGE	A0	B0	K0	D0	D1	E	E1	E2	P0	P1	P2	T
SD-8 (12 mm)	6.40 ±0.10	5.20 ±0.10	2.10 ±0.10	1.60 ±0.10	1.50 +0.10	12.00 ±0.30	1.75 ±0.10	5.50 ±0.05	8.00 ±0.10	4.00 ±0.10	2.00 ±0.05	0.25 ±0.05

SO-8 Reel

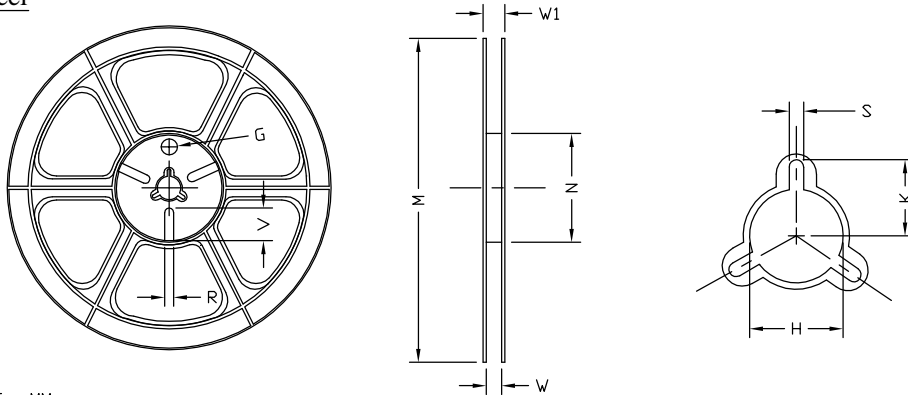

UNIT: MM

TAPE SIZE	REEL SIZE	M	N	W	W1	H	K	S	G	R	V
12 mm	ø330	ø330.00 ±0.50	ø97.00 ±0.10	13.00 ±0.30	17.40 ±1.00	ø13.00 +0.50 -0.20	10.60	2.00 ±0.50	---	---	---

SO-8 Tape

Leader / Trailer
& Orientation

