

DRAGONFLY

Interconnection Systems



High Density Signal and Power Connectors



Positronic Industries
www.connectpositronic.com



Dragonfly

High Density Signal/ Power Interconnection Systems

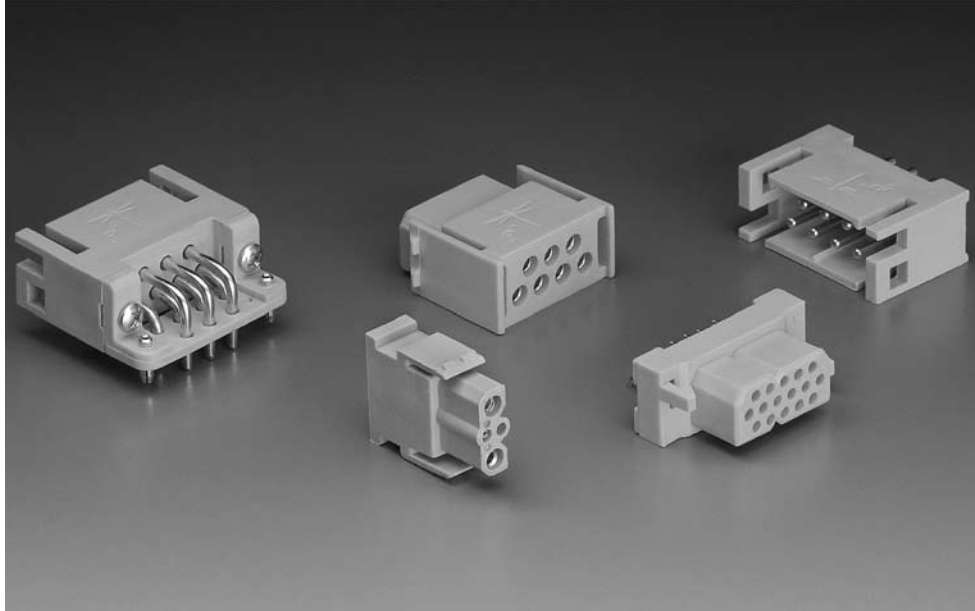

Unless otherwise specified, dimensional tolerances are:

- 1) Male contact mating diameters : ± 0.03 [0.001]
- 2) Contact termination diameters : ± 0.08 [0.003]
- 3) All other diameters : ± 0.13 [0.005]
- 4) All other dimensions : ± 0.38 [0.015]

Dimensions are in millimeters [inches]. All dimensions are subject to change.

CATALOG NUMBER: A-002 rev. B

Products described within this catalog may be protected by one or more of the following U.S. patents:

#4,721,472 #4,900,261 #5,255,580 #5,329,697 #6,260,268

Patented in Canada, 1992

Other Patents pending.

Unless otherwise stated, Positronic code and part number are marked on each connector. The contents of the code are subjected to the discretion of Positronic and it is for internal use only. Marking may be done on either side or both sides of the connector.

Positronic believes the data contained herein to be reliable. Since the technical information is given free of charge, the user employs such information at his own discretion and risk. Positronic assumes no responsibility for results obtained or damages incurred from use of such information in whole or in part.





Typical Connection Systems

System 1

Straight Board Mounting to Cable

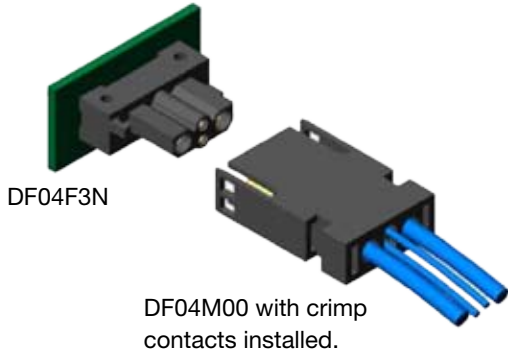

System 2

Straight Board Mounting to Right Angle Board Mounting

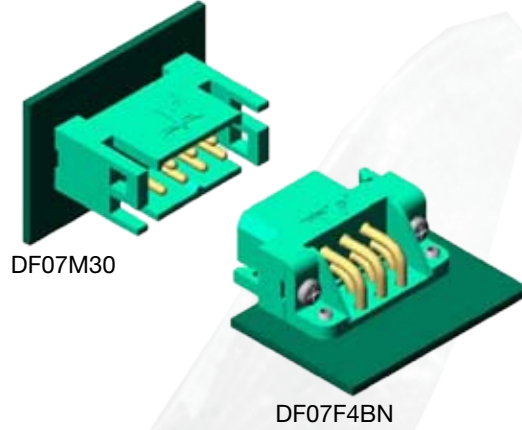

System 3

Right Angle Board Mounting to Cable

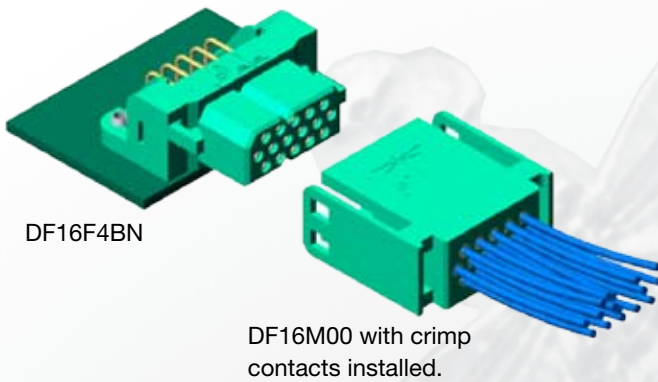

System 5

Cable Connector and Hood with Cable Clamp DF07F0W1

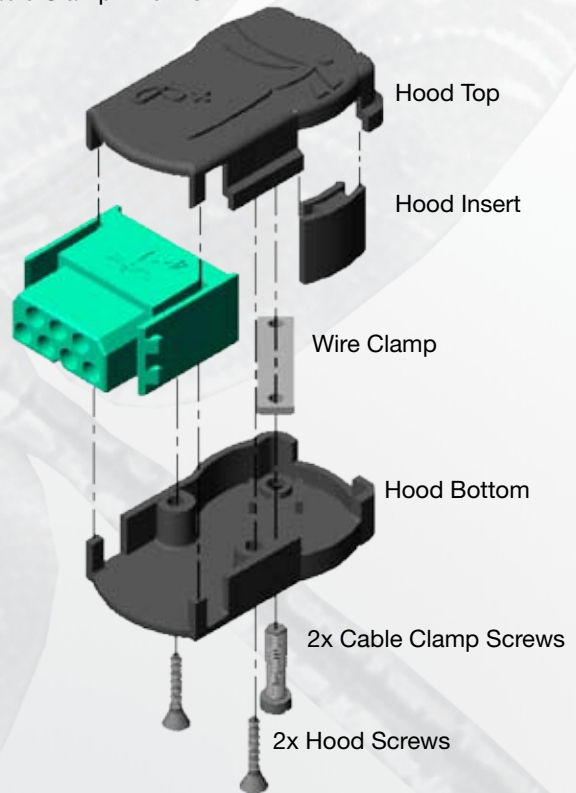

System 4

Cable to Cable

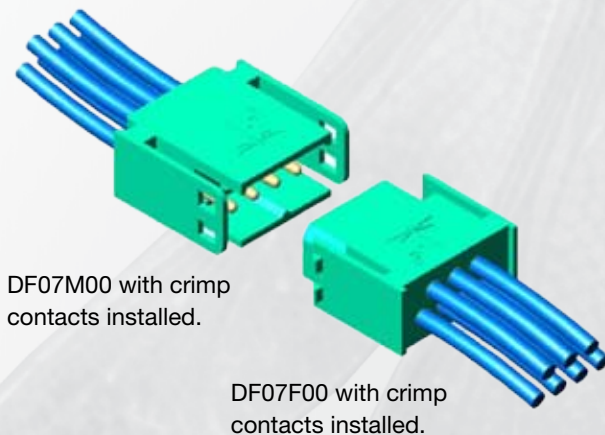



Connector Versions and Technical Characteristics



Connector Versions

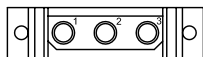

**Version 03
Power Contact
Connector**

Three (3) Size 16
Power Contacts



**Version 04
Mixed Density
Contact Connector**

Two (2) Size 16 Power
Contacts and Two (2)
Size 22 Signal Contacts
Specify Code 04 in Step 2

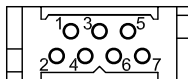

**Version 07
Power Contact
Connector**

Seven (7) Size 16
Power Contacts
Specify Code 07 in Step 2

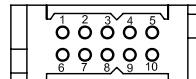

**Version 10
Signal/ Power Contact
Connector**

Ten (10) Size 20 Signal/
Power Contacts
Specify Code 10 in Step 2

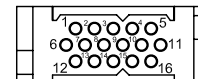

**Version 16
High Density Signal
Contact Connector**

Sixteen (16) Size 22
Signal Contacts
Specify Code 16 in Step 2

Technical Characteristics

Materials and Finishes:

- Insulator: Glass-filled nylon, UL 94V-0, green for versions 07, 10 and 16. Black color for version 04.
- Hood (W1): Polypropylene, UL 94V-0. Black color.
- Hood (W2): Glass-filled nylon, UL 94V-0. Black color.
- Contacts: Precision machined copper alloy with gold over nickel plate.
- Push-on fasteners: Copper alloy with tin plate.
- Screws: Steel with zinc plate and chromate seal.

Electrical Characteristics:

- Contact Current Rating:
 - Size 16 Contacts: 20.0 amperes, continuous.
 - Size 20 Contacts: 7.5 amperes, nominal.
12.0 amperes, continuous with AWG 18 wires.
 - Size 22 Contacts: 3.0 amperes, nominal.
- Initial Contact Resistance
Max (per IEC 512-2, Test 2b) :
 - Size 16 Contacts: 0.003 ohms
 - Size 20 Contacts: 0.005 ohms.
 - Size 22 Contacts: 0.005 ohms.
- Insulator Resistance:
5 G ohms (per IEC 512-2, Test 3a).
- Voltage Proof:
 - Size 16 Contacts: 1500 V r.m.s.
 - Size 20 Contacts: 1000 V r.m.s.
 - Size 22 Contacts: 1000 V r.m.s.
- Working Voltage:
 - Size 16 Contacts: 500 V r.m.s.
 - Size 20 Contacts: 333 V r.m.s.
 - Size 22 Contacts: 333 V r.m.s.

Climatic Characteristic:

Working temperature: -55°C to +105°C.

Mechanical Characteristics:

- Connection Systems: Connector provides cable to cable, cable to printed board and printed board to printed board mating systems.
- Locking Systems: Insulators provide locking between cable to cable and cable to printed board applications.
- Polarization: Provided in insulator design.
- Removable Contacts: Install contact from rear of insulator, release with extraction tool from front of insulator. Female contacts feature "closed entry" 1,000 cycle design. (Size 16 contact tested to 10,000 cycles. See page 3.) "Open entry" 500 cycle design also available.
- Fixed Contacts: Size 16 female contact features "closed entry" 1,000 cycles design for both straight and right angle (90°) PCB mount. Size 22 female contact features "open entry" design. "Closed entry" available on request. Size 20 female contact features both "closed entry" and "open entry" design options. See ordering informations.
- Removable Contact Retention in Insulator
 - Size 16 Contacts: 45 N [10 lbs.] Min.
 - Size 20 Contacts: 27 N [6 lbs.] Min.
 - Size 22 Contacts: 27 N [6 lbs.] Min.
- Fixed Contact Retention in Insulator
 - Size 16 Contacts: 45 N [10 lbs.] Min.
 - Size 20 Contacts: 27 N [6 lbs.] Min.
 - Size 22 Contacts: 27 N [6 lbs.] Min.
- Sequential Mating: Consult factory for details.
- Recognized:** UL File E49351.





Temperature Rise Curve and Contact Performance



Temperature Rise Curve

Tested per IEC 512-3, Test 5a

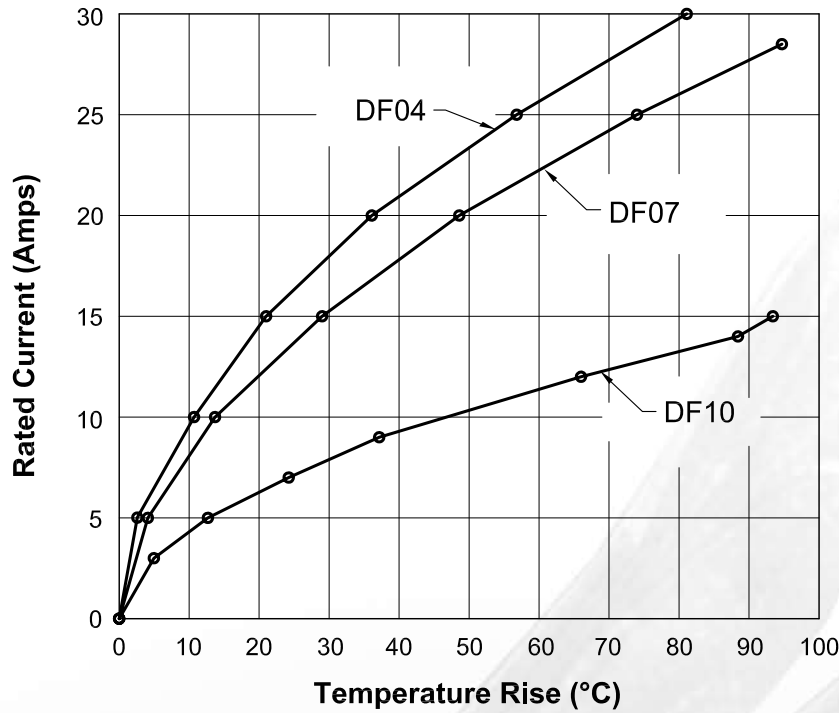

Above curves developed separately using (a) DF04 connectors and AWG 12 wires, and (b) DF07 connectors and AWG 12 wires and (c) DF10 connectors and AWG 18 wires. All power contacts under load.

10,000 Cycles Contact Performance

Contact resistance tested per IEC 512-2, Test 2b

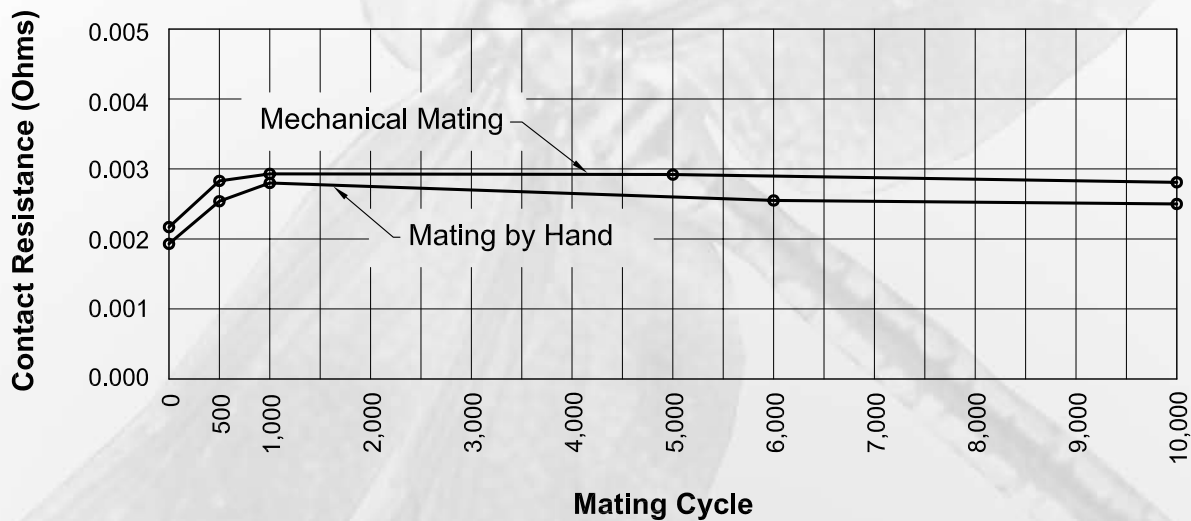

Above curves developed using DF07 connectors fully populated with size 16 contacts. This information is supplied for reference. Contact wear and change in contact resistance may vary from one application to another. Contact technical sales to discuss details.





Dragonfly Version 04 Straight and Right Angle (90°) PCB Mount Connectors



DF04 Outline Dimensions

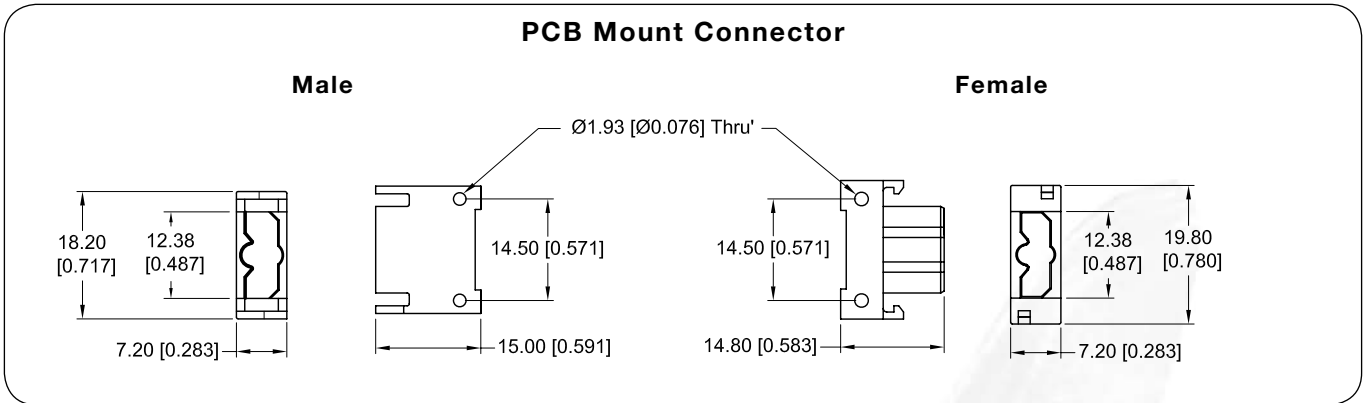

Contact Termination Dimensions

See Step 4 of Ordering Information

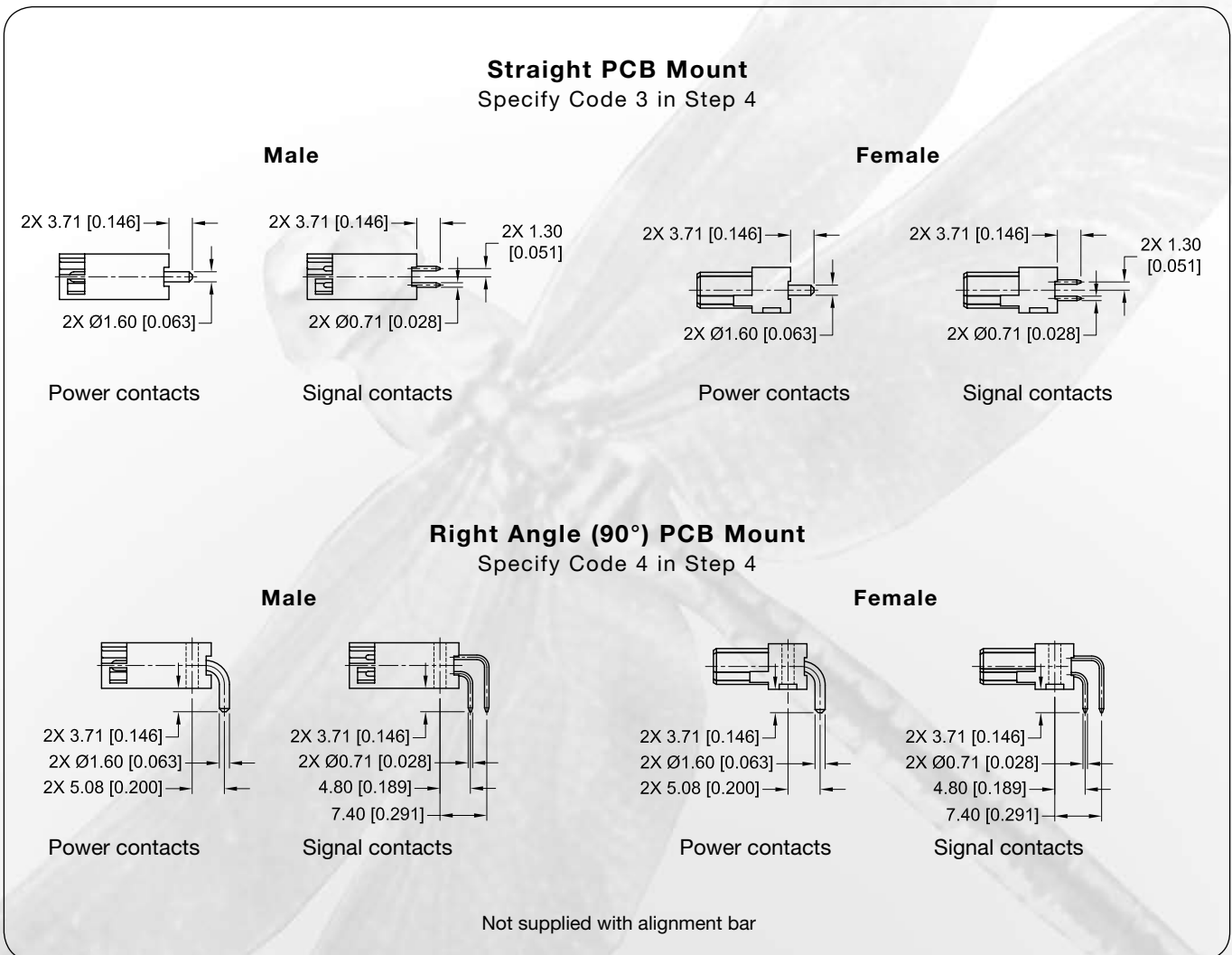



Dragonfly Version 04 Right Angle (90°) PCB Mount (Longer Insulator Version) and Removable Contact Cable Connectors



DF04 Outline Dimensions

PCB Mount Connector (Longer Insulator)

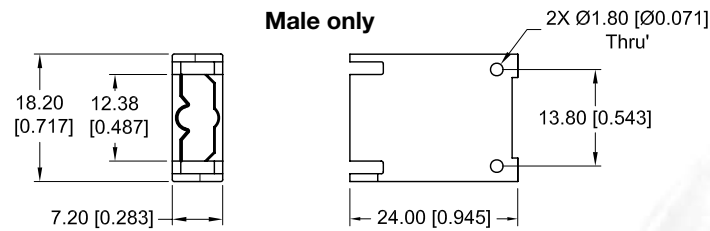

Contact Termination Dimensions

See Step 4 of Ordering Information

Right Angle (90°) PCB Mount

Specify Code 42 in Step 4

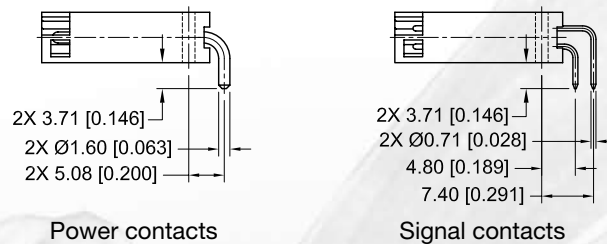

Removable Contact Cable Connectors

Specify Code 0 in Step 4 of Ordering Information

Outline Dimensions



Removable contacts should be allowed to float after terminated and installed in connector body. This enables superior mating performance. Consult factory if alignment insert for male contacts is desired.





Dragonfly Version 07 PCB Mount Connectors and Removable Contact Cable Connectors



DF07 Outline Dimensions

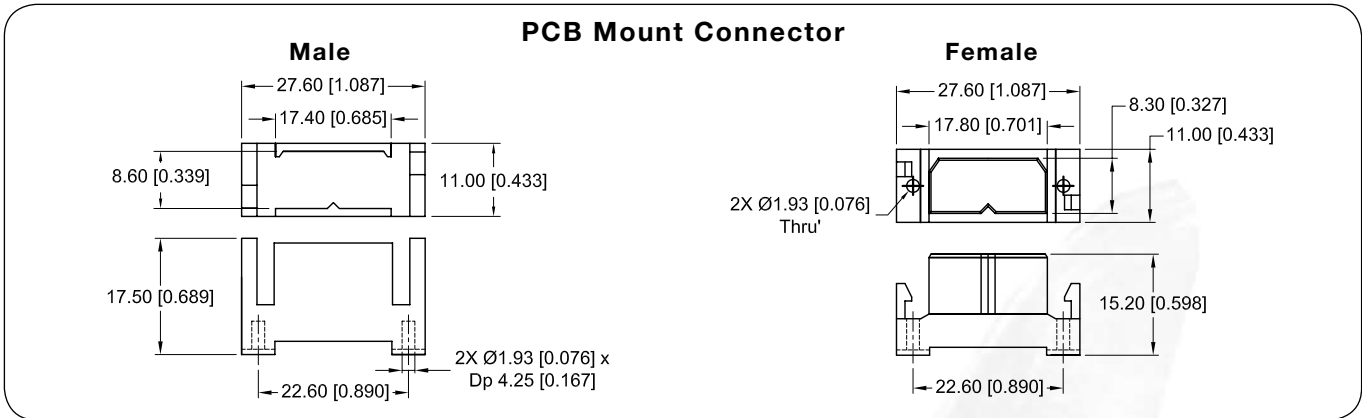

Contact Termination Dimensions

See Step 4 of Ordering Information

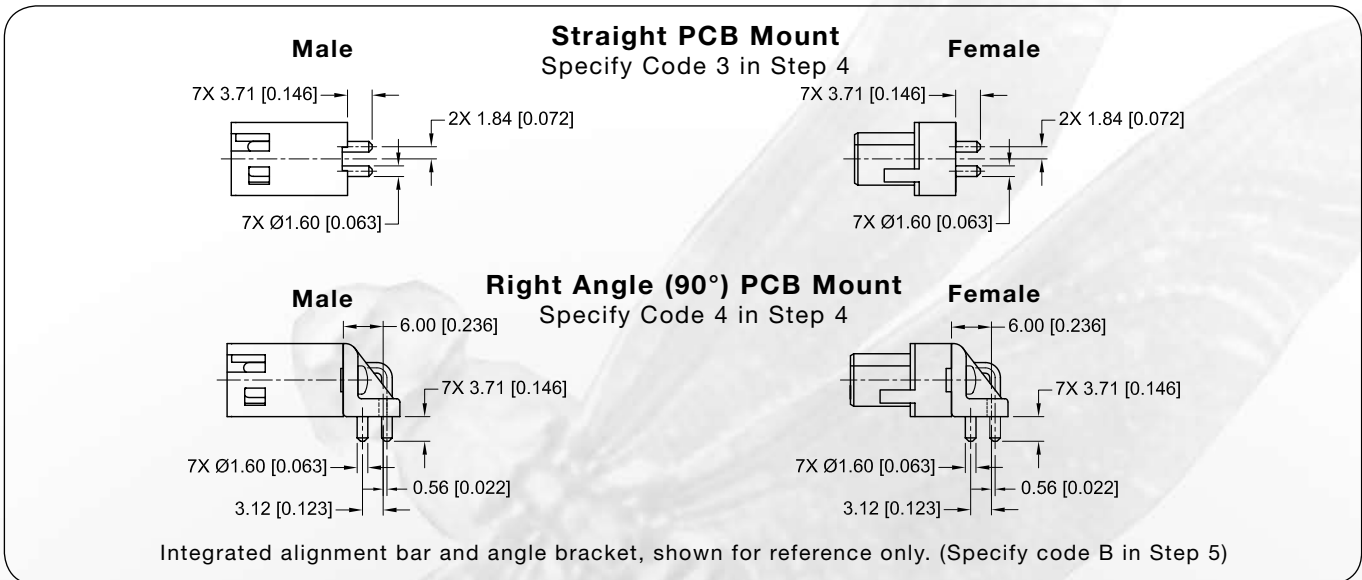

Removable Contact Cable Connectors

Specify Code 0 in Step 4 of Ordering Information

Outline Dimensions



Removable contacts should be allowed to float after terminated and installed in connector body. This enables superior mating performance. Consult factory if alignment insert for male contacts is desired.





Dragonfly Versions 10 and 16 PCB Mount Connectors and Contact Termination Dimensions



DF10 and DF16 Outline Dimensions

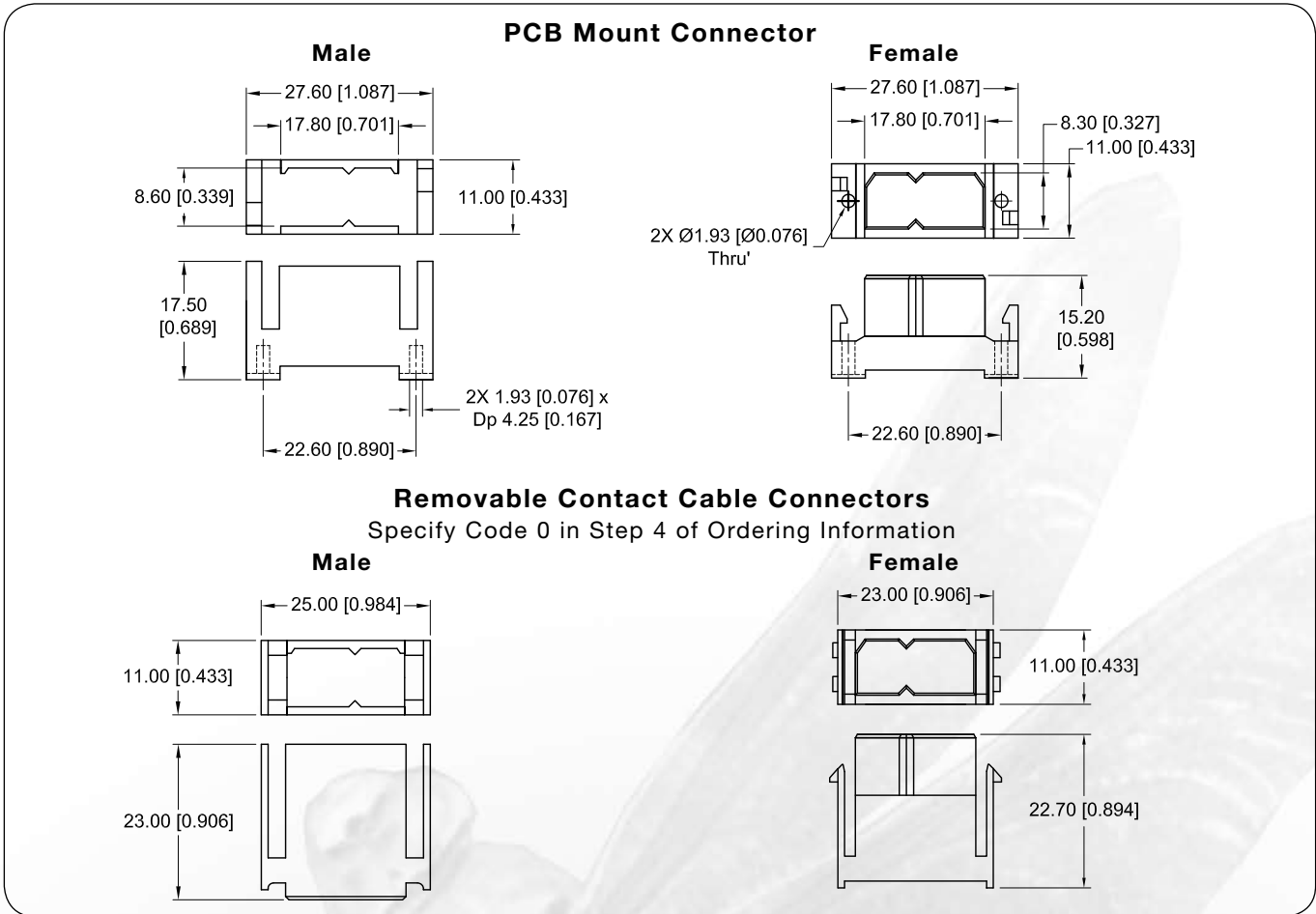

Removable contacts should be allowed to float after terminated and installed in connector body. This enables superior mating performance. Consult factory if alignment insert for male contacts is desired.

Version 10 PCB Mount Contact Termination Dimensions

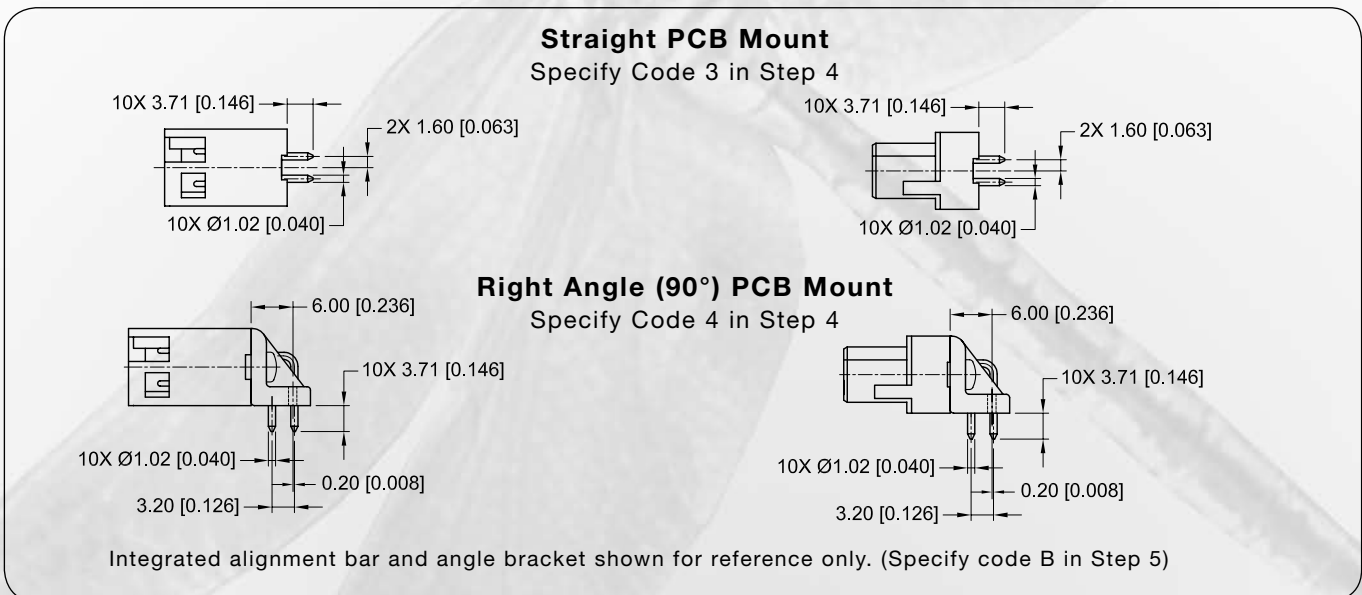



Version 16 PCB Mount Contact Termination Dimensions

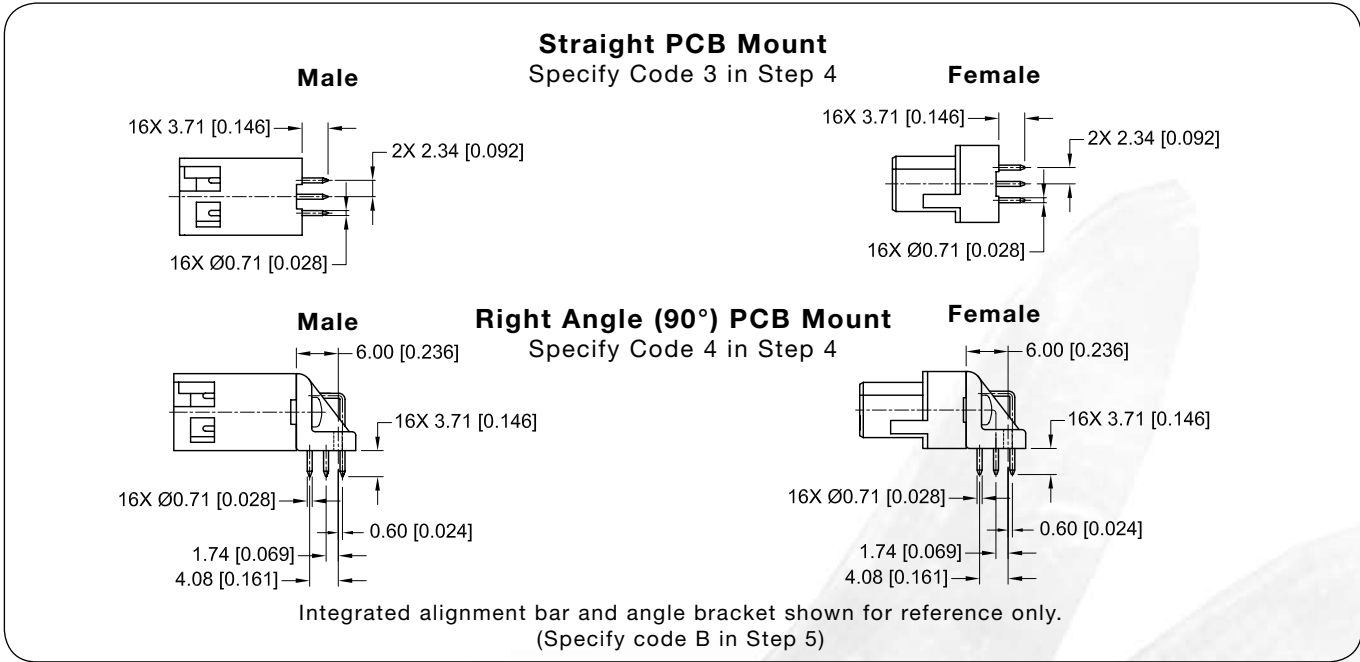

Version 04 PCB Mount - Contact Hole Patterns

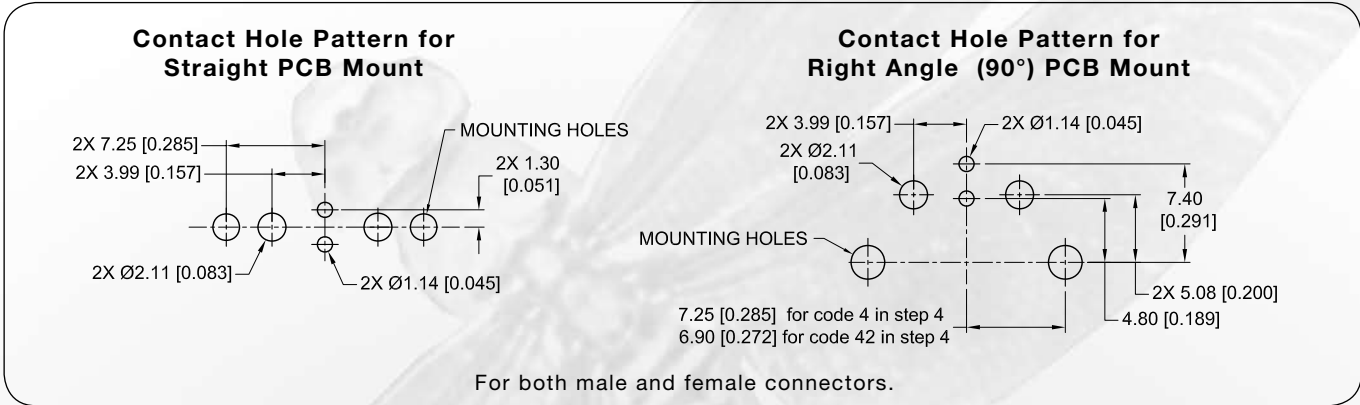

Version 07 PCB Mount - Contact Hole Patterns

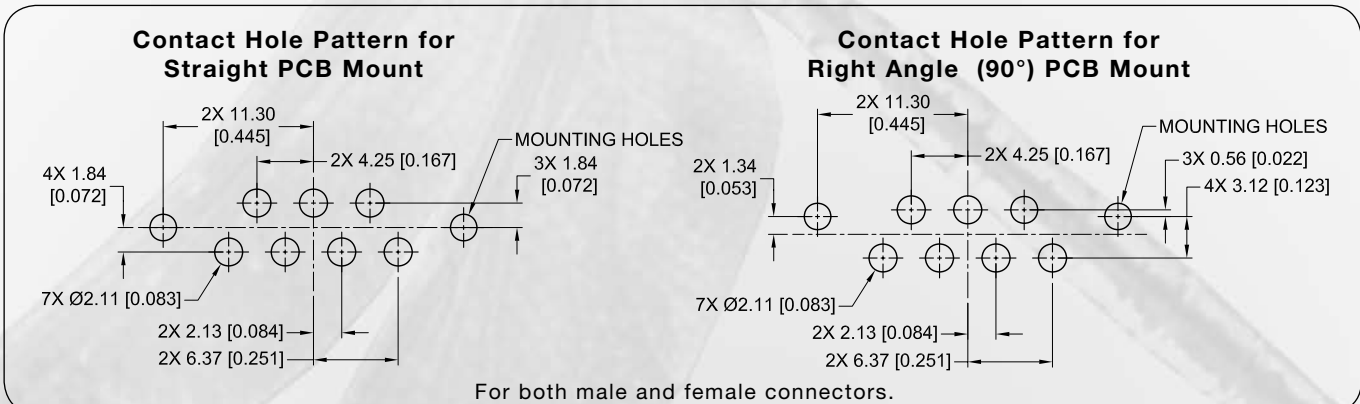

Suggested $\text{Ø}2.00 \pm 0.08$ [0.079 ± 0.003] holes for mounting connector with push-on fasteners.
Suggested $\text{Ø}2.54$ [0.100] holes for mounting connector with screws.





Version 10 PCB Mount - Contact Hole Patterns

Contact Hole Patterns for Straight PCB Mount

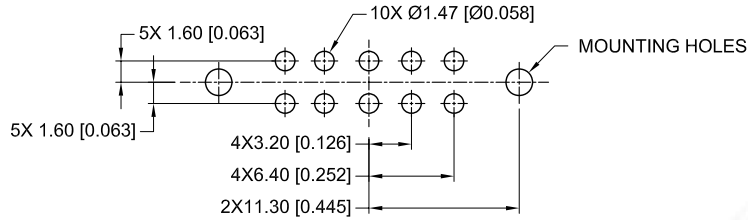

Contact Hole Pattern for Right Angle (90°) PCB Mount

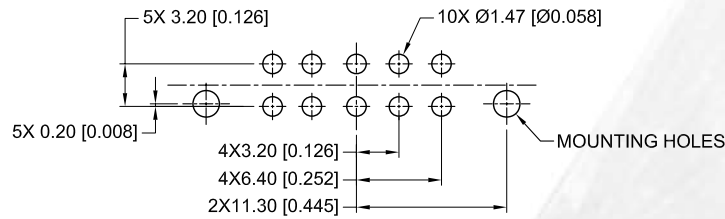

For both male and female connectors.

Contact Hole Patterns for Version 16 PCB Mount

Contact Hole Pattern for Straight PCB Mount

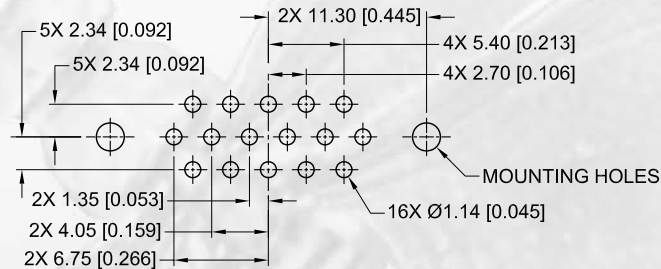

Contact Hole Pattern for Right Angle (90°) PCB Mount

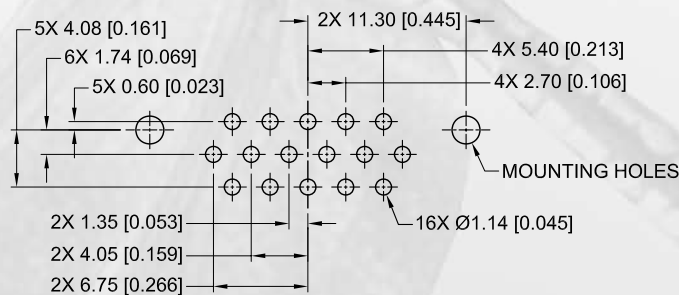

For both male and female connectors.

Suggested $\text{Ø}2.00 \pm 0.08$ [0.079 ± 0.003] holes for mounting connector with push-on fasteners.
Suggested $\text{Ø}2.54$ [0.100] holes for mounting connector with screws.





Panel Mount Option

For Male Crimp Connectors of Versions 07, 10 and 16 only
(Specify Code P in Step 5)

Flange Dimensions

Panel Cutout

Suggested Installation to Panel:
Suggested installation of connector to panel with screws and nuts.
(Screws and nuts shown for reference only)

Materials and Finishes:
Flange: Glass-filled nylon, UL 94V-0.
Flange supplied factory installed to connector

Push-on Fasteners

Available on all connectors except Version 04 code 42 contacts

Straight PCB mount version

Specify code N in Step 5

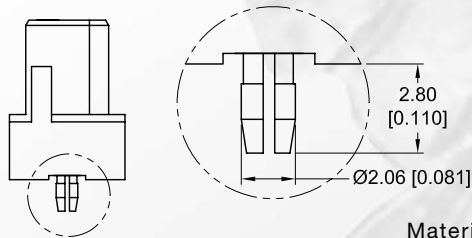

Right Angle (90°) PCB mount version

Specify code BN in Step 5

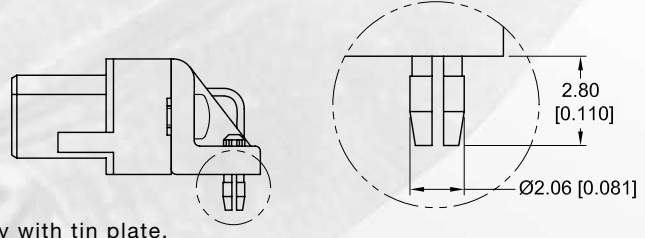

Material: Copper alloy with tin plate.

Mounting Screws Ordering Information

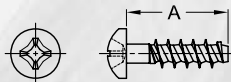

Connector Variant	Screw Part Number	Screw Length "A"	Recommended PCB Thickness
DF04*3/93*	4546-7-1-16	6.35 [0.250]	2.20 [0.087] to 3.50 [0.138]
	4546-7-2-16	7.93 [0.312]	3.60 [0.142] to 4.50 [0.177]
DF04*4/42*	4546-32-1-16	8.00 [0.315]	1.40 [0.055] to 4.00 [0.157]
	4546-32-2-16	10.00 [0.393]	3.00 [0.118] to 6.00 [0.236]
DF07*3/93* DF10*3/98* DF16*3/98*	4546-7-1-16	6.35 [0.250]	1.40 [0.055] to 3.00 [0.118]
	4546-7-2-16	7.93 [0.312]	3.00 [0.118] to 4.00 [0.157]
DF07/10/16*4*	4546-7-0-16	4.78 [0.188]	2.00 [0.079] maximum

Compliant Press-Fit Terminations PCB Straight Mount Connector Installation Tools Ordering Information

Catalog Part Number	Seating Tool Part Number	Support Tool Part Number
DF04F930	9513-309-21	9513-404-4
DF04M930	9513-309-22	
DF07F930	9513-309-25	9513-404-5
DF07M930	9513-309-24	
DF10F980	9513-309-26	9513-404-6
DF10M980	9513-309-27	
DF16F980	9513-309-20	9513-404-3
DF16M980	9513-309-23	



Hood - Top and Side Opening

For Versions 07, 10 and 16 only
Specify code W1 in Step 5

Outline Dimensions

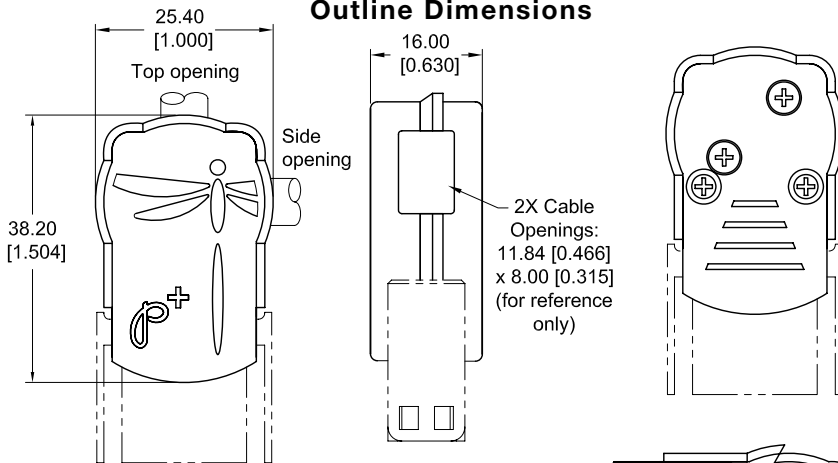

Hood comes supplied with extra insert for unused opening.



Materials and Finishes:

Hood Top and Bottom, Insert: Polypropylene, UL 94V-0, black.

Cable Clamp: Steel with nickel plate.

Hood and Cable Clamp Screws: Steel with black oxide or Steel with zinc plate and chromate seal.

Note: "W1" Hood may not accommodate fully populated connector using thick insulation 12, 14 and 16 AWG wires. Customer review recommended

Hood - Top Opening - Wide Body

For Versions 07, 10 and 16 only (for partially and fully populated connector)
Specify code W2 in Step 5

Outline Dimensions

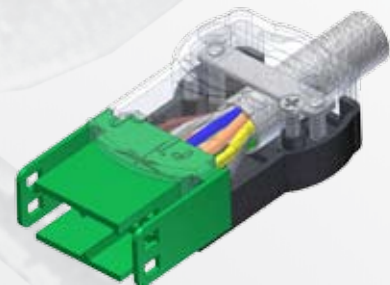
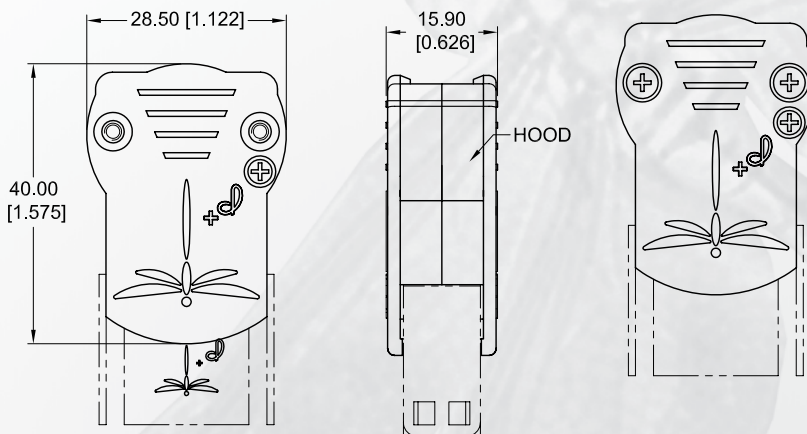

Note: "W2" Hood are able to accommodate fully populated connector using thick insulation 12, 14 and 16 AWG wires.

Materials and Finishes:

Hood: Glass-filled nylon, UL 94V-0, black.

Cable Clamp: Steel with nickel plate.

Hood and Cable Clamp Screws: Steel with black oxide or Steel with zinc plate and chromate seal.

Top opening:
16.50 [0.650]
x 9.00 [0.354]
(for reference only)





Size 16 contact
Rated 20.0 amperes ("Closed entry" 1,000 cycles minimum)

Male Contact

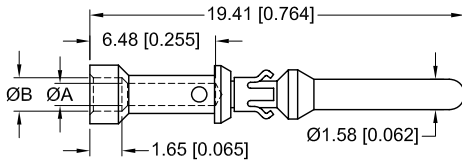

Female Contact (Closed entry)

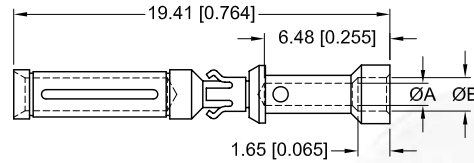

Male Contact	Female Contact	Wire Size AWG [mm ²]	ØA	ØB
MC112N	FC112N2	12 [4.0]	2.49 [0.098]	N/A
MC114N	FC114N2	14-16 [2.5-1.5]	2.06 [0.081]	2.67 [0.105]
MC116N	FC116N2	16-18 [1.5-1.0]	1.70 [0.067]	2.36 [0.093]
MC120N	FC120N2	20-22-24 [0.5-0.3-0.25]	1.14 [0.045]	1.73 [0.068]

Note: Size 16 contacts tested to 10,000 cycles performance as shown in graph on page 3. This does not insure similar performance under different conditions. Wear in mating area of contacts does occur. Customer review recommended.

Size 20 contact
Rated up to 12.0 amperes ("Closed entry" 1,000 cycles minimum)

Male Contact
MC718N / MC720N

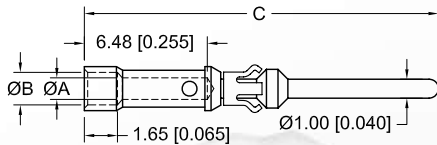

Female Contact
FC718N2 / FC720N2
 (Closed entry)

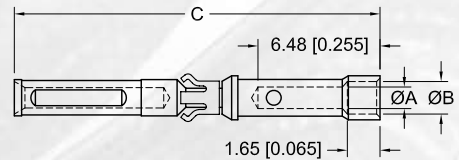

Contact Part Number	Wire Size AWG [mm ²]	ØA	ØB	C
MC718N	18 [1.0]	1.40 [0.055]	N/A	18.80 [0.740]
FC718N2		1.40 [0.055]		18.24 [0.718]
FC718N7		1.37 [0.054]		18.80 [0.740]
*MC720N	20-22-24 [0.5-0.3-0.25]	1.14 [0.045]	1.73 [0.068]	18.80 [0.740]
*FC720N2				19.41 [0.764]
*FC720N7				18.80 [0.740]

Female Contact
FC718N7 / FC720N7
 (Open entry, 500 cycles)

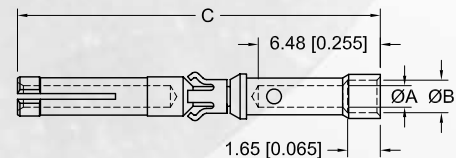

* Contact rated 7.5 amperes

Size 22 contact
Rated 3.0 amperes ("Closed entry" 1,000 cycles minimum)

MC422N

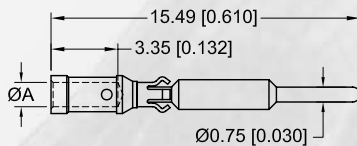

FC422N2

(Closed entry)

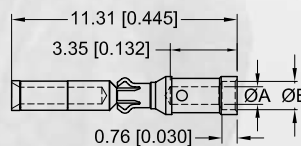

FC422N7

(Open entry, 500 cycles)

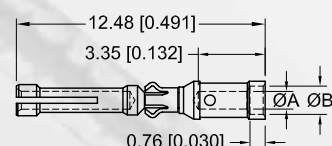

Male Contact	Female Contact	Wire Size AWG [mm ²]	ØA	ØB
MC422N	FC422N2	22 [0.3]	0.89 [0.035]	1.42 [0.056]
	FC422N7			

Please use correct wire size and it should be smaller than ØA of the contact. Consult factory for other contact sizes, materials and termination styles.





COMPLIANT PRESS-FIT CONNECTORS
FOR CONNECTOR VERSIONS 04, 07, 10 AND 16

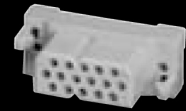

SUGGESTED PRINTED BOARD HOLE SIZES COMPLIANT PRESS-FIT CONNECTORS

Traditionally, tin-lead has been a popular plating for PBC holes. However, many PCB hole platings must now be RoHS Compliant. Positronic is pleased to offer **PCB HOLE SIZE FOR RoHS** PCB plating as shown below.

BI-SPRING COMPLIANT PRESS-FIT CONTACT HOLE				
BOARD TYPE	CONTACT SIZE	DRILL HOLE SIZE	RECOMMENDED PLATING	FINISHED HOLE SIZES
TIN-LEAD SOLDER PCB	16	$\phi 1.750 \pm 0.025$ [$\phi 0.0689 \pm 0.0010$]	15 μ [0.0006] minimum solder over 25 μ [0.0010] min. copper	$\phi 1.600 \pm 0.090 - 0.060$ [$\phi 0.0630 \pm 0.0035 - 0.0024$]
RoHS PCB PLATING OPTIONS				
COPPER PCB	16	$\phi 1.73 \pm 0.05$ [$\phi 0.068 \pm 0.002$]	25 μ [0.0010] min. copper	$\phi 1.600 \pm 0.090 - 0.060$ [$\phi 0.0630 \pm 0.0035 - 0.0024$]
IMMERSION TIN PCB	16	$\phi 1.73 \pm 0.05$ [$\phi 0.068 \pm 0.002$]	0.85 $\pm 0.15\mu$ [0.000033 ± 0.000006] immersion tin over 25 μ [0.0010]min. copper	$\phi 1.600 \pm 0.090 - 0.060$ [$\phi 0.0630 \pm 0.0035 - 0.0024$]
IMMERSION SILVER PCB	16	$\phi 1.73 \pm 0.05$ [$\phi 0.068 \pm 0.002$]	0.34 $\pm 0.17\mu$ [0.000013 ± 0.000007] immersion silver over 25 μ [0.0010] min. copper	$\phi 1.600 \pm 0.090 - 0.060$ [$\phi 0.0630 \pm 0.0035 - 0.0024$]
ELECTROLESS NICKEL/IMMERSION GOLD PCB	16	$\phi 1.73 \pm 0.05$ [$\phi 0.068 \pm 0.002$]	0.05 μ [0.000002] min. immersion gold over 4.5 $\pm 1.5\mu$ [0.000177 ± 0.000059] electroless nickel per IPC-4552 over 25 μ [0.0010]min. copper	$\phi 1.600 \pm 0.090 - 0.060$ [$\phi 0.0630 \pm 0.0035 - 0.0024$]

OMEGA COMPLIANT PRESS-FIT CONTACT HOLE				
BOARD TYPE	CONTACT SIZE	DRILL HOLE SIZE	RECOMMENDED PLATING	FINISHED HOLE SIZES
TIN-LEAD SOLDER PCB	20 22	$\phi 1.150 \pm 0.025$ [$\phi 0.0453 \pm 0.0010$]	15 μ [0.0006] minimum solder over 25 μ [0.0010] min. copper	$\phi 1.000 \pm 0.090 - 0.060$ [$\phi 0.0394 \pm 0.0035 - 0.0024$]
RoHS PCB PLATING OPTIONS				
COPPER PCB	20 22	$\phi 1.19 \pm 0.05$ [$\phi 0.047 \pm 0.002$]	25 μ [0.0010] min. copper	$\phi 1.09 \pm 0.05$ [$\phi 0.043 \pm 0.002$]
IMMERSION TIN PCB	20 22	$\phi 1.19 \pm 0.05$ [$\phi 0.047 \pm 0.002$]	0.85 $\pm 0.15\mu$ [0.000033 ± 0.000006] immersion tin over 25 μ [0.0010]min. copper	$\phi 1.09 \pm 0.05$ [$\phi 0.043 \pm 0.002$]
IMMERSION SILVER PCB	20 22	$\phi 1.19 \pm 0.05$ [$\phi 0.047 \pm 0.002$]	0.34 $\pm 0.17\mu$ [0.000013 ± 0.000007] immersion silver over 25 μ [0.0010]min. copper	$\phi 1.09 \pm 0.05$ [$\phi 0.043 \pm 0.002$]
ELECTROLESS NICKEL/IMMERSION GOLD PCB	20 22	$\phi 1.19 \pm 0.05$ [$\phi 0.047 \pm 0.002$]	0.05 μ [0.000002] min. immersion gold over 4.5 $\pm 1.5\mu$ [0.000177 ± 0.000059] electroless nickel per IPC-4552 over 25 μ [0.0010] min. copper	$\phi 1.09 \pm 0.05$ [$\phi 0.043 \pm 0.002$]

Note:

- DF04 - uses size 16 bi-spring press-fit and size 22 omega press-fit contacts.
- DF07 - uses size 16 bi-spring press-fit contacts.
- DF10 - uses size 20 omega press-fit contacts.
- DF16 - uses size 22 omega press-fit contacts.

“Bi-Spring” Termination

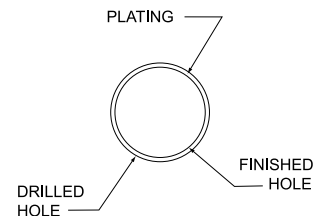
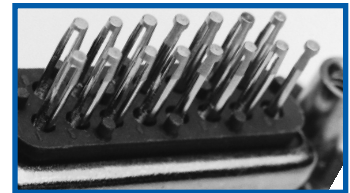

PRESS-FIT CONTACT HOLE

Note: For PCB plating compositions not shown, consult Technical Sales.

“Omega” Termination





Connector Ordering Information

Specify complete connector by following step 1 to 5



Step	1	2	3	4	5	6		7
Example	DF	07	M	3	N	/AA	-	XXX

<p>STEP 1 : Basic Series DF : Dragonfly Series</p> <p>STEP 2 : Connector Versions 04 : Mixed density contact connector two (2) size 16 power contacts and two (2) size 22 signal contacts 07 : Power contact connector seven (7) size 16 power contacts 10 : Signal/ power contact connector ten (10) size 20 signal/ power contacts 16 : High density signal contact connector sixteen (16) size 22 signal contacts</p> <p>STEP 3 : Connector Gender M : Male F : Female</p> <p>STEP 4 : Type of Contact 0 : Removable contact. (contacts ordered separately). *3 : Solder, straight PCB mount. 31 : Solder, open-entry, straight PCB mount. (For female connectors of version 10 only.) *4 : Solder, right angle (90°) PCB mount. 41 : Solder, open-entry, right angle PCB mount. (For female connectors of version 10 only.) 42 : Solder, right angle (90°) PCB mount. (For version 04 male only. Using Longer Insulator.) 93 : Press-fit, compliant termination straight pcb mount. (For versions 04 and 07 only.) 98 : Press-fit, compliant termination straight pcb mount. (For versions 10 and 16 only.)</p> <p><small>*Standard female contact is closed-entry for Versions 07 and 10. *Standard female contact is open-entry for Version 16.</small></p>	<p>STEP 7 : Special Options Consult factory for customization of connectors. Example: Selective loading, sequential mating, etc.</p> <p>STEP 6: Environmental Compliance Options /AA : Compliant per EU Directive 2002/95/EC (RoHS) Note: If compliance to environmental legislation is not required, this step will not be used. Example: DF16F30</p> <p>STEP 5 : Mounting Style, Hoods, Panel Mount 0 : No hardware. For mounting connector with self-tapping screws. (Order screws separately.) N : Push-on fasteners. B : Plastic 90° Mounting Bracket. For versions 07, 10 and 16 only. BN : Plastic 90° mounting bracket with push-on fasteners. For versions 07, 10 and 16 only. W1 : Top and side opening hood. For versions 07, 10 and 16 only. W2 : Top opening hood-wide body For versions 07, 10 and 16 only. P : Panel mount adaptor for male crimp connectors of versions 07, 10 and 16 only.</p> <p>Note: For suggested straight mount pcb holes sizes of compliant press-fit connectors, please consult factory.</p>
---	---

Recommended Tools for Crimp Contacts

Contact Extraction Tool



Contact Insertion Tool



Cycle-Controlled Step Adjustable Hand Crimp Tool



Contact Size	Contact Extraction Tool	Contact Insertion Tool	Hand Crimp Tool	Semi-Automatic Crimp Machine
Size 16	9081-0	9099-0	9501-0 with 9502- 1 positioner	9550-0
Size 20	9081-2	9099-4	9507-0 with 9502-21 positioner (Male) 9507-0 with 9502-22 positioner (Female)	9550-1
Size 22	9081-3	9099-1	9507-0 with 9502-12 positioner (Male) 9507-0 with 9502-13 positioner (FC422N2) 9507-0 with 9502-23 positioner (FC422N7)	

Consult factory for details on semi-automatic crimp machine. Above tools were shown for reference only.



NORTH AMERICAN SALES OFFICES

United States, Springfield, Missouri

Factory and Sales Office 417 866 2322
Puerto Rico Sales Office 800 641 4054
Mexico Sales Office 800 872 7674
Canada Sales Office 800 327 8272

info@connectpositronic.com

EUROPEAN SALES OFFICES

France, Auch Factory and Sales 335 6263 4491
Northern France Sales Office 331 4588 1388
Southern France Sales Office 335 6263 4491
Italy Sales Office 3902 5411 6106
Germany Sales Office 4923 5163 4739
United Kingdom Sales Office 44 1993 831 939

contact@connectpositronic.com
jchalaux@connectpositronic.com
plafon@connectpositronic.com
rmagni@connectpositronic.com
cbouche@connectpositronic.com
lbridwell@connectpositronic.com

Europe & Middle East Technical Agents:

Finland, United Kingdom, Scotland, Israel, Norway, Sweden, Turkey and the Ukraine.

ASIA / PACIFIC SALES OFFICES

Singapore Factory, Sales and Engineering Office
Singapore +65 6842 1419
Japan +813 5812 7720
South Korea +82 31 909 8047
India +91 20 2439 4810
Taiwan +886 2 2937 8775
China
Zhuhai (Factory) +86 756 362 6466
Beijing & Xian +86 29 8839 5306
Shenzhen +86 755 2643 7578
Shanghai +86 158 2907 9779
Malaysia +60 4 644 9688
New Zealand +64 3 358 5154
Australia +61 2 4362 3477

singapore@connectpositronic.com
japan@connectpositronic.com
korea@connectpositronic.com
india@connectpositronic.com
taiwan@connectpositronic.com

china@connectpositronic.com
xian@connectpositronic.com
shenzhen@connectpositronic.com
shanghai@connectpositronic.com

newzealand@connectpositronic.com
australia@connectpositronic.com

POSITRONIC INDUSTRIES, INC

423 N Campbell Avenue, P O Box 8247,
Springfield, MO 65801, USA
Telephone: 1 417 866 2322
Fax: 1 417 866 4115
Email: info@connectpositronic.com

POSITRONIC INDUSTRIES, SAS

Zone Industrielle Est, 46 Route d'Engachies,
F32020, Auch Cedex 9, France
Telephone: 335 62 63 44 91
Telecopieur: 335 62 63 51 17
Email: contact@connectpositronic.com

POSITRONIC ASIA PTE LTD

3014A Ubi Road 1 # 07-01 Singapore 408703
Telephone: 65 6842 1419 Fax: 65 6842 1421
Email: singapore@connectpositronic.com

www.connectpositronic.com



Positronic Industries
www.connectpositronic.com



DRAAGONNELLY