

General Description

MIC20XX family of switches are current limiting, high-side power switches, designed for general purpose power distribution and control in digital televisions (DTV), printers, set top boxes (STB), PCs, PDAs, and other peripheral devices (see *Functionality Table* and *Pin Configuration* drawings)

MIC20XX family's primary functions are current limiting and power switching. They are thermally protected and will shutdown should their internal temperature reach unsafe levels, protecting both the device and the load, under high-current or fault conditions

Features include fault reporting, fault blanking to eliminate noise-induced false alarms, output slew rate limiting, under voltage detection, automatic-on output, and enable pin with choice of either active low or active high enable. The FET is self-contained, with a fixed- or user-adjustable current limit. The MIC20XX family is ideal for any system where current limiting and power control are desired.

The MIC201X ($3 \leq x \leq 9$) and MIC2019A switches offer a unique new patented feature: Kickstart™, which allows momentary high-current surges up to the secondary current limit (I_{LIMIT_2nd}) without sacrificing overall system safety.

The MIC20xx family is offered, depending on the desired features, in a space-saving 5-pin SOT-23, 6-pin SOT-23, and 2mm x 2mm MLF® packages.

Datasheets and support documentation can be found on Micrel's web site at: www.micrel.com.

Features

- **MIC20X3 – MIC20X9**
70mΩ typical on-resistance @ 5V
- **MIC2005A/20X9A**
170mΩ typical on-resistance @ 5V
- Enable active high or active low
- 2.5V – 5.5V operating range
- Pre-set current limit values of 0.5A, 0.8A, and 1.2A*
- Adjustable current limit 0.2A to 2.0A* (MIC20X7-MIC20X9)
- Adjustable current limit 0.1A to 0.9A* (MIC20X9A)
- Undervoltage lock-out (UVLO)
- Variable UVLO allows adjustable UVLO thresholds*
- Automatic load discharge for capacitive loads*
- Soft-start prevents large current inrush
- Adjustable slew rate allows custom slew rates*
- Automatic-on output after fault
- Thermal protection

* Available on some family members

Applications

- Digital televisions (DTV)
- Set top boxes
- PDAs
- Printers
- USB / IEEE 1394 power bus distribution
- Desktop and laptop PCs
- Game consoles
- Docking stations

Typical Application



Figure 1. Typical Application Circuit

Kickstart is a trademark of Micrel, Inc.

MLF and MicroLeadFrame are registered trademarks of Amkor Technology, Inc.

CableCARD is a trademark of CableLabs.

Protected by U.S. Patent No. 7,170,732

Ordering Information

MIC2003/2013

| Part Number ⁽¹⁾ | Marking ⁽²⁾ | Current Limit | Kickstart™ | Package |
|----------------------------|------------------------|---------------|------------|----------------------|
| MIC2003-0.5YM5 | <u>FD</u> 05 | 0.5A | No | 5-Pin SOT-23 |
| MIC2003-0.8YM5 | <u>FD</u> 08 | 0.8A | | |
| MIC2003-1.2YM5 | <u>FD</u> 12 | 1.2A | | |
| MIC2003-0.5YML | <u>D</u> 05 | 0.5A | | 6-Pin 2mm x 2mm MLF® |
| MIC2003-0.8YML | <u>D</u> 08 | 0.8A | | |
| MIC2003-1.2YML | <u>D</u> 12 | 1.2A | | |
| MIC2013-0.5YM5 | <u>FL</u> 05 | 0.5A | Yes | 5-Pin SOT-23 |
| MIC2013-0.8YM5 | <u>FL</u> 08 | 0.8A | | |
| MIC2013-1.2YM5 | <u>FL</u> 12 | 1.2A | | |
| MIC2013-0.5YML | <u>L</u> 05 | 0.5A | | 6-Pin 2mm x 2mm MLF® |
| MIC2013-0.8YML | <u>L</u> 09 | 0.8A | | |
| MIC2013-1.2YML | <u>L</u> 12 | 1.2A | | |

MIC2004/2014

| Part Number ⁽¹⁾ | Marking ⁽²⁾ | Current Limit | Kickstart™ | Package |
|----------------------------|------------------------|---------------|------------|----------------------|
| MIC2004-0.5YM5 | <u>FE</u> 05 | 0.5A | No | 5-Pin SOT-23 |
| MIC2004-0.8YM5 | <u>FE</u> 08 | 0.8A | | |
| MIC2004-1.2YM5 | <u>FE</u> 12 | 1.2A | | |
| MIC2004-0.5YML | <u>E</u> 05 | 0.5A | | 6-Pin 2mm x 2mm MLF® |
| MIC2004-0.8YML | <u>E</u> 08 | 0.8A | | |
| MIC2004-1.2YML | <u>E</u> 12 | 1.2A | | |
| MIC2014-0.5YM5 | <u>FM</u> 05 | 0.5A | Yes | 5-Pin SOT-23 |
| MIC2014-0.8YM5 | <u>FM</u> 08 | 0.8A | | |
| MIC2014-1.2YM5 | <u>FM</u> 12 | 1.2A | | |
| MIC2014-0.5YML | <u>M</u> 05 | 0.5A | | 6-Pin 2mm x 2mm MLF® |
| MIC2014-0.8YML | <u>M</u> 09 | 0.8A | | |
| MIC2014-1.2YML | <u>M</u> 12 | 1.2A | | |

Notes:

- All MIC20XX Family parts are RoHS-compliant lead free.
- Over/Under-bar symbol (/) may not be to scale. On the package the over/under symbol begins above/below the first character of the marking.

Ordering Information (Continued)

MIC2005

| Part Number ⁽¹⁾ | Marking ⁽²⁾ | Current Limit | Enable | Kickstart™ | Package |
|----------------------------|------------------------|---------------|-------------|------------|----------------------|
| MIC2005-0.5YM6 | <u>FF</u> 05 | 0.5A | Active High | No | 6-Pin SOT-23 |
| MIC2005-0.8YM6 | <u>FF</u> 08 | 0.8A | Active High | | |
| MIC2005-1.2YM6 | <u>FF</u> 12 | 1.2A | Active High | | |
| MIC2005-0.5YML | <u>F</u> 05 | 0.5A | Active High | | 6-Pin 2mm x 2mm MLF® |
| MIC2005-0.8YML | <u>F</u> 08 | 0.8A | Active High | | |
| MIC2005-1.2YML | <u>F</u> 12 | 1.2A | Active High | | |

MIC2005L

| Part Number ⁽¹⁾ | Marking ⁽²⁾ | Current Limit | Enable | Kickstart™ | Package |
|----------------------------|------------------------|---------------|------------|------------|--------------|
| MIC2005-0.5LYM5 | <u>5L</u> FF | 0.5A | Active Low | No | 5-Pin SOT-23 |
| MIC2005-0.8LYM5 | <u>8L</u> FF | 0.8A | Active Low | | |
| MIC2005-1.2LYM5 | <u>4L</u> FF | 1.2A | Active Low | | |

MIC2005A

| Part Number ⁽¹⁾ | Marking ⁽²⁾ | Current Limit | Enable | Kickstart™ | Package |
|----------------------------|------------------------|---------------|-------------|------------|--------------|
| MIC2005A-1YM5 | <u>FA</u> 51 | 0.5A | Active High | No | 5-Pin SOT-23 |
| MIC2005A-2YM5 | <u>FA</u> 52 | 0.5A | Active Low | | |
| MIC2005A-1YM6 | <u>FA</u> 53 | 0.5A | Active High | | 6-Pin SOT-23 |
| MIC2005A-2YM6 | <u>FA</u> 54 | 0.5A | Active Low | | |

MIC2015

| Part Number ⁽¹⁾ | Marking ⁽²⁾ | Current Limit | Enable | Kickstart™ | Package |
|----------------------------|------------------------|---------------|-------------|------------|----------------------|
| MIC2015-0.5YM6 | <u>FN</u> 05 | 0.5A | Active High | Yes | 6-Pin SOT-23 |
| MIC2015-0.8YM6 | <u>FN</u> 08 | 0.8A | Active High | | |
| MIC2015-1.2YM6 | <u>FN</u> 12 | 1.2A | Active High | | |
| MIC2015-0.5YML | <u>N</u> 05 | 0.5A | Active High | | 6-Pin 2mm x 2mm MLF® |
| MIC2015-0.8YML | <u>N</u> 08 | 0.8A | Active High | | |
| MIC2015-1.2YML | <u>N</u> 12 | 1.2A | Active High | | |

Notes:

- All MIC20XX Family parts are RoHS-compliant lead free.
- Over/Under-bar symbol (/) may not be to scale. On the package the over/under symbol begins above/below the first character of the marking.

Ordering Information (Continued)

MIC2006/2016

| Part Number ⁽¹⁾ | Marking ⁽²⁾ | Current Limit | Kickstart™ | Package |
|----------------------------|------------------------|---------------|------------|----------------------|
| MIC2006-0.5YM6 | <u>FG</u> 05 | 0.5A | No | 6-Pin SOT-23 |
| MIC2006-0.8YM6 | <u>FG</u> 08 | 0.8A | | |
| MIC2006-1.2YM6 | <u>FG</u> 12 | 1.2A | | |
| MIC2006-0.5YML | <u>G</u> 05 | 0.5A | | 6-Pin 2mm x 2mm MLF® |
| MIC2006-0.8YML | <u>G</u> 08 | 0.8A | | |
| MIC2006-1.2YML | <u>G</u> 12 | 1.2A | | |
| MIC2016-0.5YM6 | <u>FP</u> 05 | 0.5A | Yes | 6-Pin SOT-23 |
| MIC2016-0.8YM6 | <u>FP</u> 08 | 0.8A | | |
| MIC2016-1.2YM6 | <u>FP</u> 12 | 1.2A | | |
| MIC2016-0.5YML | <u>P</u> 05 | 0.5A | | 6-Pin 2mm x 2mm MLF® |
| MIC2016-0.8YML | <u>P</u> 09 | 0.8A | | |
| MIC2016-1.2YML | <u>P</u> 12 | 1.2A | | |

MIC2007/2017

| Part Number ⁽¹⁾ | Marking ⁽²⁾ | Current Limit | Kickstart™ | Package |
|----------------------------|------------------------|---------------|------------|----------------------|
| MIC2007YM6 | <u>FH</u> AA | 0.2A – 2.0A | No | 6-Pin SOT-23 |
| MIC2007YML | <u>H</u> AA | | | 6-Pin 2mm x 2mm MLF® |
| MIC2017YM6 | <u>FQ</u> AA | | Yes | 6-Pin SOT-23 |
| MIC2017YML | <u>Q</u> AA | | | 6-Pin 2mm x 2mm MLF® |

MIC2008/2018

| Part Number ⁽¹⁾ | Marking ⁽²⁾ | Current Limit | Kickstart™ | Package |
|----------------------------|------------------------|---------------|------------|----------------------|
| MIC2008YM6 | <u>FJ</u> AA | 0.2A – 2.0A | No | 6-Pin SOT-23 |
| MIC2008YML | <u>J</u> AA | | | 6-Pin 2mm x 2mm MLF® |
| MIC2018YM6 | <u>FR</u> AA | | Yes | 6-Pin SOT-23 |
| MIC2018YML | <u>R</u> AA | | | 6-Pin 2mm x 2mm MLF® |

MIC2009/2019

| Part Number ⁽¹⁾ | Marking ⁽²⁾ | Current Limit | Kickstart™ | Package |
|----------------------------|------------------------|---------------|------------|----------------------|
| MIC2009YM6 | <u>FK</u> AA | 0.2A – 2.0A | No | 6-Pin SOT-23 |
| MIC2009YML | <u>K</u> AA | | | 6-Pin 2mm x 2mm MLF® |
| MIC2019YM6 | <u>FS</u> AA | | Yes | 6-Pin SOT-23 |
| MIC2019YML | <u>S</u> AA | | | 6-Pin 2mm x 2mm MLF® |

Notes:

- All MIC20XX Family parts are RoHS-compliant lead free.
- Over/Under-bar symbol (/) may not be to scale. On the package the over/under symbol begins above/below the first character of the marking.

Ordering Information (Continued)

MIC2009A/2019A

| Part Number ⁽¹⁾ | Marking ⁽²⁾ | Current Limit | Kickstart™ | Enable | Package |
|----------------------------|------------------------|---------------|------------|-------------|--------------|
| MIC2009A-1YM6 | FK1 | 0.1 A – 0.9 A | No | Active High | 6-pin SOT-23 |
| MIC2009A-2YM6 | FK2 | | | Active Low | |
| MIC2019A-1YM6 | FS1 | | Yes | Active High | |
| MIC2019A-2YM6 | FS2 | | | Active Low | |

Notes:

- All MIC20XX Family parts are RoHS-compliant lead free.
- Over/Under-bar symbol (¯ / _) may not be to scale. On the package the over/under symbol begins above/below the first character of the marking.

MIC20XX Family Member Functionality

| Part Number | | I _{LIMIT} | Pin Function | | | | | | |
|-----------------|---------------------------|----------------------|--------------------|-------------|------------|------------------|--------|----------------------|----------------|
| Normal Limiting | Kickstart™ ⁽¹⁾ | | I _{LIMIT} | ENABLE High | ENABLE Low | CSLEW | FAULT/ | VUVLO ⁽⁵⁾ | Load Discharge |
| 2003 | 2013 | Fixed ⁽²⁾ | – | – | – | – | – | – | – |
| 2004 | 2014 | | – | ▲ | – | – | – | – | ▲ |
| 2005 | 2015 | | – | ▲ | – | ▲ | ▲ | – | – |
| 2005L | – ⁽¹⁾ | | – | – | ▲ | – | ▲ | – | – |
| 2005A-1 | – ⁽¹⁾ | | – | ▲ | – | – ⁽⁶⁾ | ▲ | – | – |
| 2005A-2 | – ⁽¹⁾ | | – | – | ▲ | – ⁽⁶⁾ | ▲ | – | – |
| 2006 | 2016 | | – | ▲ | – | ▲ | – | ▲ | – |
| 2007 | 2017 | Adj. ⁽³⁾ | ▲ | ▲ | – | ▲ | – | – | ▲ |
| 2008 | 2018 | | ▲ | ▲ | – | ▲ | – | – | – |
| 2009 | 2019 | | ▲ | ▲ | – | – | ▲ | – | – |
| 2009A-1 | 2019A-1 | | ▲ | ▲ | – | – | ▲ | – | – |
| 2009A-2 | 2019A-2 | | ▲ | – | ▲ | – | ▲ | – | – |

Notes:

- Kickstart™ provides an alternate start-up behavior; however, pin-outs are identical.
- Kickstart™ not available.
- Fixed = Factory-programmed current limit.
- Adj. = User adjustable current limit.
- VUVLO = Variable UVLO (Previously called DML).
- CSLEW not available in 5-pin package.

MIC20XX Family Member Pin Configuration Table, SOT Packages

| Part Number | | I _{LIMIT} | Pin Number | | | | | |
|-----------------|------------------|----------------------|------------|-----|----|----------------------|--------|------|
| Normal Limiting | Kickstart™ | | 1 | 2 | 3 | 4 | 5 | 6 |
| 2003 | 2013 | Fixed ⁽²⁾ | VIN | GND | NC | NC | VOUT | — |
| 2004 | 2014 | | VIN | GND | EN | NC | VOUT | — |
| 2005 | 2015 | | VIN | GND | EN | FAULT/ | CSLEW | VOUT |
| 2005L | — ⁽¹⁾ | | VIN | GND | EN | FAULT/ | VOUT | — |
| 2005Axxx6 | — ⁽¹⁾ | | VIN | GND | EN | FAULT/ | CSLEW | VOUT |
| 2005Axxx5 | — ⁽¹⁾ | | VIN | GND | EN | FAULT/ | VOUT | — |
| 2006 | 2016 | | VIN | GND | EN | VUVLO ⁽⁴⁾ | CSLEW | VOUT |
| 2007 | 2017 | Adj. ⁽³⁾ | VIN | GND | EN | ILIMIT | CSLEW | VOUT |
| 2008 | 2018 | | VIN | GND | EN | ILIMIT | CSLEW | VOUT |
| 2009 | 2019 | | VIN | GND | EN | FAULT/ | ILIMIT | VOUT |
| 2009A | 2019A | | VIN | GND | EN | FAULT/ | ILIMIT | VOUT |

Notes:

1. Kickstart™ not available.
2. Fixed = Factory-programmed current limit.
3. I_{LIMIT} = User adjustable current limit.
4. VUVLO = Variable UVLO (Previously called DLM).

MIC20XX Family Member Pin Configuration Table, MLF[®] Packages ⁽⁵⁾

| Part Number | | I Limit | Pin Number | | | | | |
|-----------------|------------|----------------------|------------|-----|----|----------------------|--------|------|
| Normal Limiting | Kickstart™ | | 6 | 5 | 4 | 3 | 2 | 1 |
| 2003 | 2013 | Fixed ⁽²⁾ | VIN | GND | NC | NC | NC | VOUT |
| 2004 | 2014 | | VIN | GND | EN | NC | NC | VOUT |
| 2005 | 2015 | | VIN | GND | EN | FAULT/ | CSLEW | VOUT |
| 2006 | 2016 | | VIN | GND | EN | VUVLO ⁽⁴⁾ | CSLEW | VOUT |
| 2007 | 2017 | Adj. ⁽³⁾ | VIN | GND | EN | ILIMIT | CSLEW | VOUT |
| 2008 | 2018 | | VIN | GND | EN | ILIMIT | CSLEW | VOUT |
| 2009 | 2019 | | VIN | GND | EN | FAULT/ | ILIMIT | VOUT |

Notes:

1. Kickstart™ not available.
2. Fixed = Factory-programmed current limit.
3. I_{LIMIT} = User adjustable current limit.
4. VUVLO = Variable UVLO (Previously called DLM).
5. Connect EP to GND.

MIC20XX Family Member Pin Configuration Drawings

Fixed Current Limit

MIC20X3



5-Pin SOT-23 (M5)



6-Pin MLF[®] (ML)
(Top View)

MIC20X4



5-Pin SOT-23 (M5)

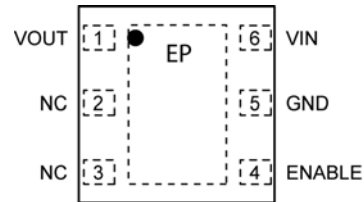

6-Pin MLF[®] (ML)
(Top View)

MIC20X5

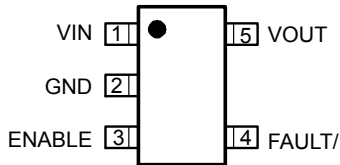

5-Pin SOT-23 (M5)
MIC2005-X.XL

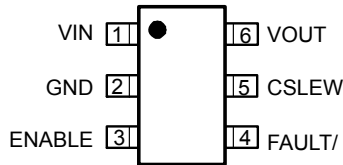

6-Pin SOT-23 (M6)
MIC20X5

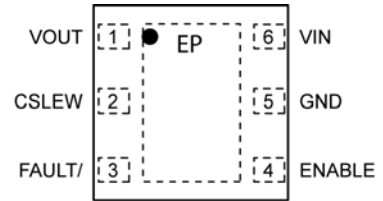

6-Pin MLF[®] (ML)
(Top View)
MIC20X5

MIC20X6



6-Pin SOT-23 (M6)

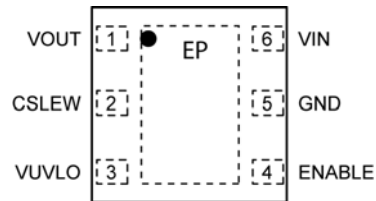

6-Pin MLF[®] (ML)
(Top View)

MIC20XX Family Member Pin Configuration Drawings (Continued)

Adjustable Current Limit

MIC20X7/20X8



6-Pin SOT-23 (M6)



6-Pin MLF[®] (ML)
(Top View)

MIC20X9



6-Pin SOT-23 (M6)

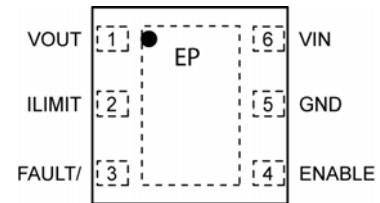

6-Pin MLF[®] (ML)
(Top View)

MIC2005A

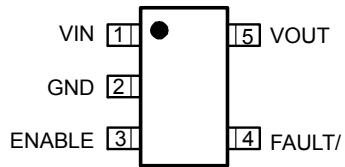

5-Pin SOT-23 (M5)



6-Pin SOT-23 (M6)

MIC2009A



6-Pin SOT-23 (M6)

Descriptions

These pin and signal descriptions aid in the differentiation of a pin from electrical signals and components connected to that pin. For example, VOUT is the switch's output pin, while V_{OUT} is the electrical signal output voltage present at the VOUT pin.

Pin Descriptions

| Pin Name | Type | Description |
|----------|---------|--|
| VIN | Input | Supply input. This pin provides power to both the output switch and the switch's internal control circuitry. |
| GND | — | Ground. |
| EN | Input | Switch Enable (Input): |
| FAULT/ | Output | Fault status. A logic LOW on this pin indicates the switch is in current limiting, or has been shut down by the thermal protection circuit. This is an open-drain output allowing logical OR'ing of multiple switches. |
| CSLEW | Input | Slew rate control. Adding a small value capacitor between this pin and VIN slows turn-ON of the power FET. |
| VOUT | Output | Switch output. The load being driven by the switch is connected to this pin. |
| VUVLO | Input | Variable Under Voltage Lockout (VUVLO): Monitors the input voltage through a resistor divider between VIN and GND. Shuts the switch off if voltage falls below the threshold set by the resistor divider. Previously called VUVLO. |
| ILIMIT | Input | Set current limit threshold via a resistor connected from ILIMIT to GND. |
| EP | Thermal | On MLF packages connect EP to GND. |

Signal Descriptions

| Signal Name | Type | Description |
|-----------------|-----------|--|
| V_{IN} | Input | Electrical signal input voltage present at the VIN pin. |
| GND | — | Ground. |
| V_{EN} | Input | Electrical signal input voltage present at the ENABLE pin. |
| $V_{FAULT/}$ | Output | Electrical signal output voltage present at the FAULT/ pin. |
| C_{SLEW} | Component | Capacitance value connected to the CSLEW pin. |
| V_{OUT} | Output | Electrical signal output voltage present at the VOUT pin. |
| V_{VUVLO_TH} | Internal | VUVLO internal reference threshold voltage. This voltage is compared to the VUVLO pin input voltage to determine if the switch should be disabled. Reference threshold voltage has a typical value of 250mV. |
| C_{LOAD} | Component | Capacitance value connected in parallel with the load. Load capacitance. |
| I_{OUT} | Output | Electrical signal output current present at the VOUT pin. |
| I_{LIMIT} | Internal | Switch's current limit. Fixed at factory or user adjustable. |

Absolute Maximum Ratings⁽¹⁾

V_{IN} , V_{OUT}-0.3V to 6V
 All other pins.....-0.3V to 5.5V
 Power Dissipation (P_D) Internally Limited
 Continuous Output Current
 All except MIC2005A / MIC20X9A..... 2.25A
 MIC2005A / 20X9A..... 1.0A
 Maximum Junction Temperature (T_J)..... 150°C
 Storage Temperature (T_S)..... -65°C to +150°C
 Lead Temperature (Soldering 10 sec)..... 260°C

Operating Ratings⁽²⁾

Supply Voltage..... 2.5V to 5.5V
 Continuous Output Current
 All except MIC2005A / MIC20X9A 0A to 2.1A
 MIC2005A/20X9A..... 0A to 0.9A
 Ambient Temperature Range (T_A).....-40°C to +85°C
 Package Thermal Resistance⁽³⁾
 SOT-23-5/6 (θ_{JA})230°C /W
 2mm × 2mm MLF[®] (θ_{JA})90°C /W
 2mm × 2mm MLF[®] (θ_{JC})45°C /W

Electrical Characteristics⁽⁴⁾

$V_{IN} = 5V$, $T_A = 25^\circ C$ unless otherwise specified. **Bold** indicates -40°C to +85°C limits; $C_{IN} = 1\mu F$.

| Symbol | Parameter | Condition | Min. | Typ. | Max. | Units |
|-------------------------------------|---------------------------------------|---|------------|------|------------|------------|
| V_{IN} | Switch Input Voltage | | 2.5 | | 5.5 | V |
| I_{LEAK} | Output Leakage Current ⁽⁵⁾ | Switch = OFF, $V_{OUT} = 0V$ Active Low Enable, $V_{EN} = 1.5V$ Active High Enable, $V_{EN} = 0V$ | | 12 | 100 | μA |
| MIC2005A, MIC2009A, MIC2019A | | | | | | |
| I_{IN} | Supply Current ⁽⁵⁾ | Switch = ON Active Low Enable, $V_{EN} = 0V$ Active High Enable, $V_{EN} = 1.5V$ | | 80 | 300 | μA |
| | | Switch = OFF Active Low Enable, $V_{EN} = 1.5V$ | | 8 | 15 | |
| | | Switch = OFF Active High Enable, $V_{EN} = 0V$ | | 1 | 5 | |
| $R_{DS(ON)}$ | Power Switch Resistance | $V_{IN} = 5V$, $I_{OUT} = 100mA$ | | 170 | 220 | m Ω |
| | | | | | 275 | |
| MIC2005A | | | | | | |
| I_{LIMIT} | Fixed Current Limit | $V_{OUT} = 0.8 \times V_{IN}$ | 0.5 | 0.7 | 0.9 | A |
| MIC2009A, MIC2019A | | | | | | |
| C_{LF} | Variable Current Limit Factors | $I_{OUT} = 0.9A$, $V_{OUT} = 0.8 \times V_{IN}$ | 172 | 211 | 263 | V |
| | | $I_{OUT} = 0.5A$, $V_{OUT} = 0.8 \times V_{IN}$ | 152 | 206 | 263 | |
| | | $I_{OUT} = 0.2A$, $V_{OUT} = 0.8 \times V_{IN}$ | 138 | 200 | 263 | |
| | | $I_{OUT} = 0.1A$, $V_{OUT} = 0.8 \times V_{IN}$ | 121 | 192 | 263 | |
| MIC2019A | | | | | | |
| I_{LIMIT_2nd} | Secondary Current Limit | $V_{IN} = 2.5V$, $V_{OUT} = 0V$ | 1 | 2 | 3 | A |

Notes:

- Exceeding the absolute maximum rating may damage the device.
- The device is not guaranteed to function outside its operating rating.
- Requires proper thermal mounting to achieve this performance
- Specifications for packaged product only.
- Check the Ordering Information section to determine which parts are Active High or Active Low.

Electrical Characteristics⁽⁴⁾ (Continued)

$V_{IN} = 5V$, $T_A = 25^\circ C$ unless otherwise specified. **Bold** indicates $-40^\circ C$ to $+85^\circ C$ limits; $C_{IN} = 1\mu F$.

| Symbol | Parameter | Condition | Min. | Typ. | Max. | Units |
|---|--------------------------------|--|------------|-------|------------|-----------|
| MIC2003-MIC2009, MIC2013-MIC2019, MIC2005-X.XL | | | | | | |
| I_{IN} | Supply Current ⁽⁵⁾ | Switch = ON Active Low Enable, $V_{EN} = 0V$ Active High Enable, $V_{EN} = 1.5V$ | | 80 | 330 | μA |
| | | Switch = OFF Active Low Enable, $V_{EN} = 1.5V$ | | 8 | 15 | |
| | | Switch = OFF Active High Enable, $V_{EN} = 0V$ | | 1 | 5 | |
| $R_{DS(ON)}$ | Power Switch Resistance | $V_{IN} = 5V$, $I_{OUT} = 100mA$ | | 70 | 100 | $m\Omega$ |
| | | | | | 125 | |
| MIC2003-X.X, MIC2004-X.X, MIC2005-X.X, MIC2006-X.X, MIC2013-X.X, MIC2014-X.X, MIC2015-X.X, MIC2016-X.X, MIC2005-X.XL | | | | | | |
| I_{LIMIT} | Fixed Current Limit | -0.5 , $V_{OUT} = 0.8 \times V_{IN}$ | 0.5 | 0.7 | 0.9 | A |
| | | -0.8 , $V_{OUT} = 0.8 \times V_{IN}$ | 0.8 | 1.1 | 1.5 | |
| | | -1.2 , $V_{OUT} = 0.8 \times V_{IN}$ | 1.2 | 1.6 | 2.1 | |
| MIC2005-0.5 | | | | | | |
| I_{LIMIT} | Fixed Current Limit | $V_{OUT} = 0.8 \times V_{IN}$ | 0.5 | 0.7 | 0.9 | A |
| MIC2007, MIC2008, MIC2009, MIC2017, MIC2018, MIC2019 | | | | | | |
| C_{LF} | Variable Current Limit Factors | $I_{OUT} = 2.0A$, $V_{OUT} = 0.8 \times V_{IN}$ | 210 | 250 | 286 | V |
| | | $I_{OUT} = 1.0A$, $V_{OUT} = 0.8 \times V_{IN}$ | 190 | 243 | 293 | |
| | | $I_{OUT} = 0.5A$, $V_{OUT} = 0.8 \times V_{IN}$ | 168 | 235 | 298 | |
| | | $I_{OUT} = 0.2A$, $V_{OUT} = 0.8 \times V_{IN}$ | 144 | 225 | 299 | |
| MIC2013, MIC2014, MIC2015, MIC2016, MIC2017, MIC2018, MIC2019 | | | | | | |
| I_{LIMIT_2nd} | Secondary Current Limit | $V_{IN} = 2.5V$, $V_{OUT} = 0V$ | 2.2 | 4 | 6 | A |
| MIC2006, MIC2016 | | | | | | |
| V_{UVLO_TH} | Variable UVLO Threshold | | 225 | 250 | 275 | mV |
| MIC20x4, MIC20x7 | | | | | | |
| R_{DSCHG} | Load Discharge Resistance | $V_{IN} = 5V$, $I_{SINK} = 5mA$ | 70 | 126 | 200 | Ω |
| MIC20X5, MIC20X6, MIC20X7, MIC20X8 | | | | | | |
| I_{CSLEW} | C_{SLEW} Input Current | $0V \leq V_{OUT} \leq 0.8V_{IN}$ | | 0.175 | | μA |

Electrical Characteristics⁽⁴⁾ (Continued)

$V_{IN} = 5V$, $T_A = 25^\circ C$ unless otherwise specified. **Bold** indicates $-40^\circ C$ to $+85^\circ C$ limits; $C_{IN} = 1\mu F$.

| Symbol | Parameter | Condition | Min. | Typ. | Max. | Units |
|---------------------|-------------------------------------|--------------------------|------------|------|------------|------------|
| All Parts | | | | | | |
| V_{EN} | ENABLE Input Voltage ⁽⁶⁾ | V_{IL} (MAX) | | | 0.5 | V |
| | | V_{IH} (MIN) | 1.5 | | | |
| I_{EN} | ENABLE Input Current | $0V \leq V_{EN} \leq 5V$ | | 1 | 5 | μA |
| $UVLO_{THRESHOLD}$ | Undervoltage Lock-Out Threshold | V_{IN} Rising | 2 | 2.25 | 2.5 | V |
| | | V_{IN} Falling | 1.9 | 2.15 | 2.4 | |
| $UVLO_{HYSTERESIS}$ | Undervoltage Lock-Out Hysteresis | | | 0.1 | | V |
| V_{FAULT} | Fault Status Output Voltage | $I_{OL} = 10mA$ | | 0.25 | 0.4 | V |
| $OT_{THRESHOLD}$ | Over-Temperature Threshold | T_J Increasing | | 145 | | $^\circ C$ |
| | | T_J Decreasing | | 135 | | |

Note:

6. $V_{IL(MAX)}$ = Maximum positive voltage applied to the input which will be accepted by the device as a logic low.
 $V_{IH(MAX)}$ = Maximum positive voltage applied to the input which will be accepted by the device as a logic high.

AC Electrical Characteristics

| Symbol | Parameter | Condition | Min. | Typ. | Max. | Units |
|----------------|--|---|------|------|------|---------|
| t_{RISE} | Output Turn-on rise time | $R_L = 10\Omega$, $C_{LOAD} = 1\mu F$, $V_{OUT} = 10\%$ to 90% $C_{SLEW}^{(7)} = Open$ | 500 | 1000 | 1500 | μs |
| t_{D_FAULT} | Delay before asserting or releasing FAULT/ MIC2003 – MIC2009 MIC2009A, MIC2005A | Time from current limiting to FAULT/ state change | 20 | 32 | 49 | ms |
| | Delay before asserting or releasing FAULT/ MIC2013 – MIC2019 MIC2019A | Time from I_{OUT} continuously exceeding primary current limit condition to FAULT/ state change | 77 | 128 | 192 | |
| t_{D_LIMIT} | Delay before current limiting MIC2013 – MIC2019 MIC2019A | | 77 | 128 | 192 | ms |
| t_{RESET} | Delay before resetting Kickstart™ current limit delay, t_{D_LIMIT} MIC2013 – MIC2019 MIC2019A | Out of current limit following a current limit event. | 77 | 128 | 192 | ms |
| t_{ON_DLY} | Output Turn-on Delay | $R_L = 43\Omega$, $C_L = 120\mu F$, $V_{EN} = 50\%$ to $V_{OUT} = 10\%$ * $C_{SLEW} = Open$ | | 1000 | 1500 | μs |
| t_{OFF_DLY} | Output Turn-off Delay | $R_L = 43\Omega$, $C_L = 120\mu F$, $V_{EN} = 50\%$ to $V_{OUT} = 90\%$ * $C_{SLEW} = Open$ | | | 700 | μs |

ESD⁽⁸⁾

| Symbol | Parameter | Condition | Min. | Typ. | Max. | Units |
|-----------------|---|---------------------------|-----------|------|------|-------|
| V_{ESD_HB} | Electro Static Discharge Voltage: Human Body Model | V_{OUT} and GND | ± 4 | | | kV |
| | | All other pins | ± 2 | | | |
| V_{ESD_MCHN} | Electro Static Discharge Voltage; Machine Model | All pins Machine Model | ± 200 | | | V |

Notes:

7. Whenever C_{SLEW} is present.
8. Devices are ESD sensitive. Handling precautions recommended. Human body model, 1.5k in series with 100pF.

Timing Diagrams



Rise and Fall Times



Switching Delay Times

Typical Characteristics

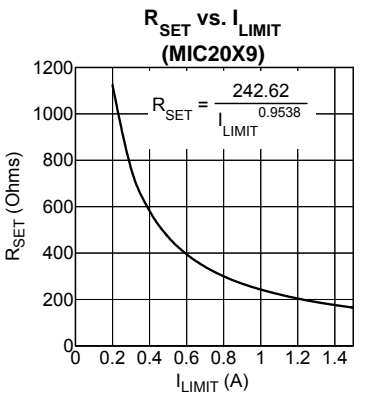
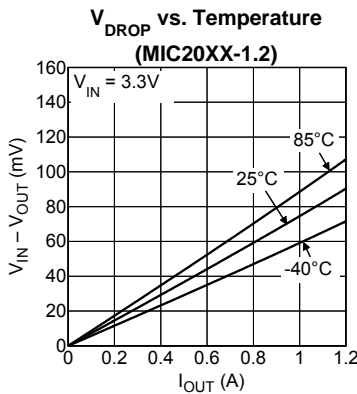
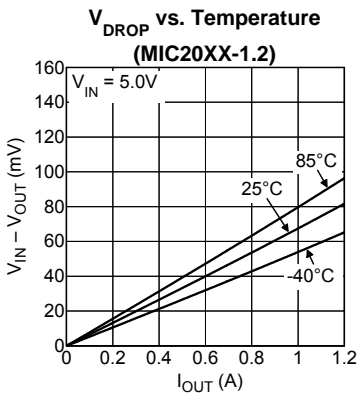
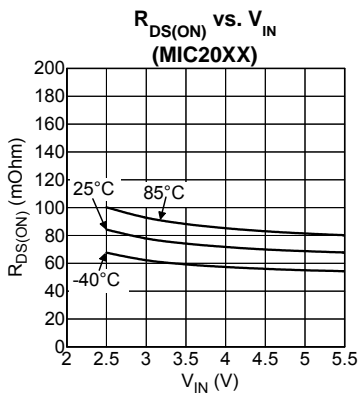

Typical Characteristics (Continued)

Supply Current Output Enabled (MIC20XXA)



Supply Current Output Disabled (MIC20XXA)



Switch Leakage Current (MIC20XXA)



I_LIMIT vs. Temperature (MIC20X5A)

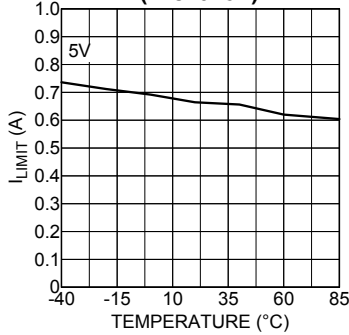

I_LIMIT vs. Temperature (MIC20X9A (0.8A))

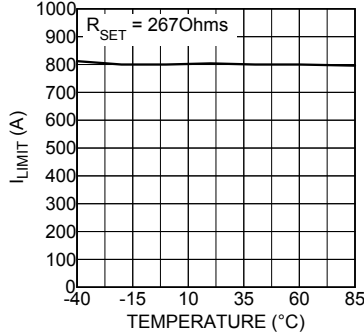

R_SET vs. I_LIMIT (MIC20X9A)

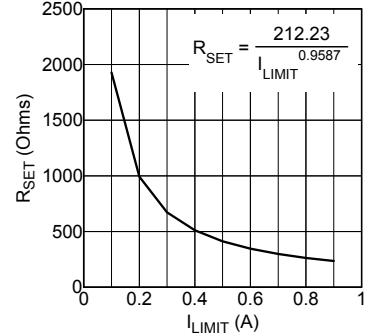

R_DS(ON) vs. V_IN (MIC20XXA)



R_DS(ON) vs. Temperature (MIC20XXA)

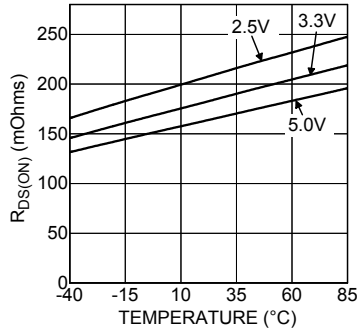

Flag Delay vs. Temperature



V_DROP vs. Temperature (MIC20XXA)



V_DROP vs. Temperature (MIC20XXA)

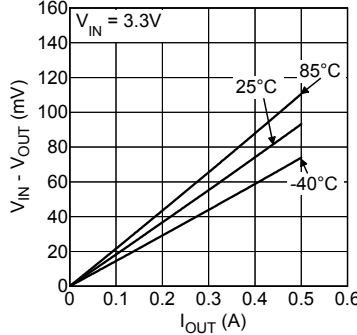

UVLO Threshold vs. Temperature



Functional Characteristics

V_{IN} Soft Turn-On



Turn-Off V_{IN}



Enable Turn-On Delay and Rise Time



Enable Turn-Off Delay and Fall Time



Enable Turn-On/Turn-Off



UVLO



Functional Characteristics (Continued)

Enabled into Short



Power Up into Short Circuit



Current Limit Response, Stepped Short



Current Limit Response Time, Stepped Short



Output Recovery from Short Circuit



Output Recovery from Thermal Shutdown



Functional Characteristics (Continued)

Current Limit Threshold



Current Inrush Current Response



**Kickstart Response
77ms/2.2A Load Step**



**Kickstart Response
150ms/2.2A Load Step**



**Kickstart Response
Recovery from Thermal Shutdown**



**Kickstart Response Time
5A Over Load**



Functional Diagram



Figure 2. MIC20XX Family Functional Diagram

Functional Description

V_{IN} and V_{OUT}

V_{IN} is both the power supply connection for the internal circuitry driving the switch and the input (Source connection) of the power MOSFET switch. V_{OUT} is the Drain connection of the power MOSFET and supplies power to the load. In a typical circuit, current flows from V_{IN} to V_{OUT} toward the load. Since the switch is bi-directional when enabled, if V_{OUT} is greater than V_{IN} , current will flow from V_{OUT} to V_{IN} .

When the switch is disabled, current will not flow to the load, except for a small unavoidable leakage current of a few microamps. However, should V_{OUT} exceed V_{IN} by more than a diode drop (~ 0.6 V), while the switch is disabled, current will flow from output to input via the power MOSFET's body diode.

If discharging C_{LOAD} is required by your application, consider using MIC20X4 or MIC20X7; these MIC20XX family members are equipped with a discharge FET to insure complete discharge of C_{LOAD} .

Current Sensing and Limiting

MIC20XX protects the system power supply and load from damage by continuously monitoring current through the on-chip power MOSFET. Load current is monitored by means of a current mirror in parallel with the power MOSFET switch. Current limiting is invoked when the load exceeds the set over-current threshold. When current limiting is activated the output current is constrained to the limit value, and remains at this level until either the load/fault is removed, the load's current requirement drops below the limiting value, or the switch goes into thermal shutdown.

Kickstart™

| | | | | | | |
|-------------|-------------|-------------|-------------|-------------|-------------|--------------|
| 2003 | 2004 | 2005X | 2006 | 2007 | 2008 | 2009X |
| 2013 | 2014 | 2015 | 2016 | 2017 | 2018 | 2019X |

Only parts in bold have Kickstart™.

(Not available in 5-pin SOT-23 packages)

The MIC201X is designed to allow momentary current surges (Kickstart™) before the onset of current limiting, which permits dynamic loads, such as small disk drives or portable printers to draw the energy needed to overcome inertial loads without sacrificing system safety. In this respect, the Kickstart™ parts (MIC201X) differs markedly from the non-Kickstart™ parts (MIC200X) which immediately limit load current, potentially starving the motor and causing the appliance to stall or stutter.

During this delay period, typically 128ms, a secondary current limit is in effect. If the load demands a current in excess the secondary limit, MIC201X acts immediately to restrict output current to the secondary limit for the duration of the Kickstart™ period. After this time the MIC201X reverts to its normal current limit. An example of Kickstart™ operation is shown in Figure 3.

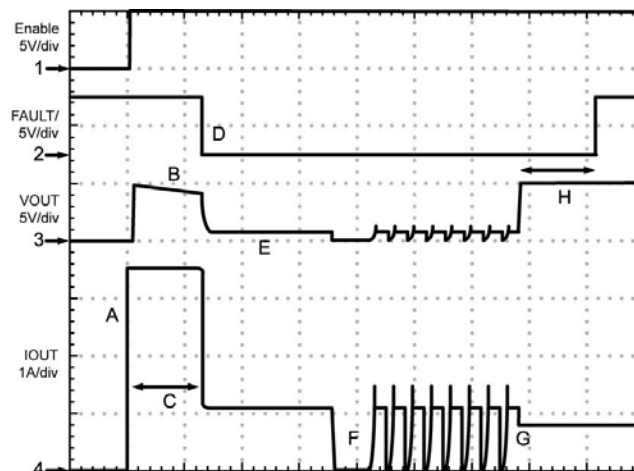

Figure 3. Kickstart™ Operation

Figure 3 Label Key:

- A. MIC201X is enabled into an excessive load (slew rate limiting not visible at this time scale) The initial current surge is limited by either the overall circuit resistance and power supply compliance, or the secondary current limit, whichever is less.
- B. R_{ON} of the power FET increases due to internal heating (effect exaggerated for emphasis).
- C. Kickstart™ period.
- D. Current limiting initiated. FAULT/ goes LOW.
- E. V_{OUT} is non-zero (load is heavy, but not a dead short where $V_{OUT} = 0$ V. Limiting response will be the same for dead shorts).
- F. Thermal shutdown followed by thermal cycling.
- G. Excessive load released, normal load remains. MIC201X drops out of current limiting.
- H. FAULT/ delay period followed by FAULT/ going HIGH.

Undervoltage Lock-Out

Undervoltage lock-out insures no anomalous operation occurs before the device's minimum input voltage of $UVLO_{THRESHOLD}$ which is 2V minimum, 2.25V typical, and 2.5V maximum had been achieved. Prior to reaching this voltage, the output switch (power MOSFET) is OFF and no circuit functions, such as FAULT/ or ENABLE, are considered to be valid or operative.

Variable Undervoltage Lock Out (VUVLO)

| | | | | | | |
|------|------|-------|-------------|------|------|-------|
| 2003 | 2004 | 2005X | 2006 | 2007 | 2008 | 2009X |
| 2013 | 2014 | 2015 | 2016 | 2017 | 2018 | 2019X |

Only parts in **bold** have VUVLO.

V_{UVLO} functions as an input voltage monitor when the switch is enabled. The V_{IN} pin is monitored for a drop in voltage, indicating excessive loading of the V_{IN} supply. When V_{IN} is less than the V_{ULVO} threshold voltage (V_{VUVLO_TH}) for 32ms or more, the MIC20XX disables the switch to protect the supply and allow V_{IN} to recover. After 128ms has elapsed, the MIC20X6 enables switch. This disable and enable cycling will continue as long as V_{IN} decreases below the V_{UVLO} threshold voltage (V_{VUVLO_TH}) which has a typical value of 250mV. The V_{UVLO} voltage is commonly established by a voltage divider from V_{IN} -to-GND.

ENABLE

| | | | | | | |
|------|-------------|--------------|-------------|-------------|-------------|--------------|
| 2003 | 2004 | 2005X | 2006 | 2007 | 2008 | 2009X |
| 2013 | 2014 | 2015 | 2016 | 2017 | 2018 | 2019X |

Only parts in **bold** have ENABLE pin.

ENABLE pin is a logic compatible input which activates the main MOSFET switch thereby providing power to the V_{OUT} pin. ENABLE is either an active HIGH or active LOW control signal. The MIC20XX can operate with logic running from supply voltages as low as 1.5 V.

ENABLE may be driven higher than V_{IN} , but no higher than 5.5V and not less than $-0.3V$.

FAULT/

| | | | | | | |
|------|------|--------------|------|------|------|--------------|
| 2003 | 2004 | 2005X | 2006 | 2007 | 2008 | 2009X |
| 2013 | 2014 | 2015 | 2016 | 2017 | 2018 | 2019X |

Only parts in **bold** have FAULT/ pin.

FAULT/ is an N-channel open-drain output, which is asserted (LOW true) when switch either begins current limiting or enters thermal shutdown.

FAULT/ asserts after a brief delay when events occur that may be considered possible faults. This delay insures that FAULT/ is asserted only upon valid, enduring, over-current conditions and that transitory event error reports are filtered out.

In MIC200X FAULT/ asserts after a brief delay period, of 32ms typical. After a fault clears, FAULT/ remains asserted for the delay period of 32ms

MIC201X's FAULT/ asserts at the end of the Kickstart™ period which is 128ms typical. This masks initial current surges, such as would be seen by a motor load starting up. If the load current remains above the current limit threshold after the Kickstart™ has timed out, then the FAULT/ will be asserted. After a fault clears, FAULT/ remains asserted for the delay of 128ms.

Because FAULT/ is an open-drain it must be pulled HIGH with an external resistor and it may be wire-OR'd with other similar outputs, sharing a single pull-up resistor. FAULT/ may be tied to a pull-up voltage source which is higher than V_{IN} , but no greater than 5.5V.

Soft-Start Control

Large capacitive loads can create significant inrush current surges when charged through the switch. For this reason, the MIC20XX family of switches provides a built-in soft-start control to limit the initial inrush currents.

Soft-start is accomplished by controlling the power MOSFET when the ENABLE pin enables the switch.

C_{SLEW}

| | | | | | | |
|------|------|--------------|-------------|-------------|-------------|-------|
| 2003 | 2004 | 2005X | 2006 | 2007 | 2008 | 2009X |
| 2013 | 2014 | 2015 | 2016 | 2017 | 2018 | 2019X |

Only parts in **bold** have C_{SLEW} pin.
(Not available in 5-pin SOT-23 packages)

The C_{SLEW} pin is provided to increase control of the output voltage ramp at turn-on. This input allows designers the option of decreasing the output's slew rate (slowing the voltage rise) by adding an external capacitance between the C_{SLEW} and V_{IN} pins.

Thermal Shutdown

Thermal shutdown is employed to protect the MIC20XX family of switches from damage should the die temperature exceed safe operating levels. Thermal shutdown shuts off the output MOSFET and asserts the FAULT/ output if the die temperature reaches 145°C.

The switch will automatically resume operation when the die temperature cools down to 135°C. If resumed operation results in reheating of the die, another shutdown cycle will occur and the switch will continue cycling between ON and OFF states until the overcurrent condition has been resolved.

Depending on PCB layout, package type, ambient temperature, etc., hundreds of milliseconds may elapse from the incidence of a fault to the output MOSFET being shut off. This delay is due to thermal time constants within the system itself. In no event will the device be damaged due to thermal overload because die temperature is monitored continuously by on-chip circuitry.

Application Information

Setting I_{LIMIT}

The MIC2009/2019's current limit is user programmable and controlled by a resistor connected between the I_{LIMIT} pin and GND. The value of this resistor is determined by the following equation:

$$I_{LIMIT} = \frac{\text{CurrentLimitFactor}(CLF)}{R_{SET}}$$

or

$$R_{SET} = \frac{\text{CurrentLimitFactor}(CLF)}{I_{LIMIT} (A)}$$

For example: Set I_{LIMIT} = 1.25A

Looking in the Electrical specifications we will find CLF at I_{LIMIT} = 1A.

| Min | Typ | Max | Units |
|-----|-----|-----|-------|
| 190 | 243 | 293 | V |

Table 1. CLF at I_{LIMIT} = 1A

For the sake of this example, we will say the typical value of CLF at an I_{OUT} of 1A is 243V. Applying the equation above:

$$R_{SET} (\Omega) = \frac{243V}{1.25A} = 194.4\Omega$$

R_{SET} = 196Ω
(the closest standard 1% value)

Designers should be aware that variations in the measured I_{LIMIT} for a given R_{SET} resistor, will occur because of small differences between individual ICs (inherent in silicon processing) resulting in a spread of I_{LIMIT} values. In the example above we used the typical value of CLF to calculate R_{SET}. We can determine I_{LIMIT}'s spread by using the minimum and maximum values of CLF and the calculated value of R_{SET}.

$$I_{LIMIT_MIN} = \frac{190V}{196\Omega} = 0.97A$$

$$I_{LIMIT_MAX} = \frac{293V}{196\Omega} = 1.5A$$

Giving us a maximum I_{LIMIT} variation over temperature of:

| | | |
|------------------------|------------------------|------------------------|
| I _{LIMIT_MIN} | I _{LIMIT_TYP} | I _{LIMIT_MAX} |
| 0.97A (-22%) | 1.25A | 1.5A (+20%) |

| I _{OUT} | R _{SET} | I _{LIMIT_MIN} | I _{LIMIT_MAX} |
|------------------|------------------|------------------------|------------------------|
| 0.1A | 1928Ω | 0.063A | 0.136A |
| 0.2A | 993Ω | 0.137A | 0.265A |
| 0.3A | 673Ω | 0.216A | 0.391A |
| 0.4A | 511Ω | 0.296A | 0.515A |
| 0.5A | 413Ω | 0.379A | 0.637A |
| 0.6A | 346Ω | 0.463A | 0.759A |
| 0.7A | 299Ω | 0.548A | 0.880A |
| 0.8A | 263Ω | 0.634A | 1.001A |
| 0.9A | 235Ω | 0.722A | 1.121A |

Table 2. MIC20x9A R_{SET} Table

| I _{OUT} | R _{SET} | I _{LIMIT_MIN} | I _{LIMIT_MAX} |
|------------------|------------------|------------------------|------------------------|
| 0.2A | 1125Ω | 0.127A | 0.267A |
| 0.3A | 765Ω | 0.202A | 0.390A |
| 0.4A | 582Ω | 0.281A | 0.510A |
| 0.5A | 470Ω | 0.361A | 0.629A |
| 0.6A | 395Ω | 0.443A | 0.746A |
| 0.7A | 341Ω | 0.526A | 0.861A |
| 0.8A | 300Ω | 0.610A | 0.976A |
| 0.9A | 268Ω | 0.695A | 1.089A |
| 1A | 243Ω | 0.781A | 1.202A |
| 1.1A | 222Ω | 0.868A | 1.314A |
| 1.2A | 204Ω | 0.956A | 1.426A |
| 1.3A | 189Ω | 1.044A | 1.537A |
| 1.4A | 176Ω | 1.133A | 1.647A |
| 1.5A | 165Ω | 1.222A | 1.757A |

Table 3. MIC20x9 R_{SET} Table

I_{LIMIT} vs. I_{OUT} Measured

The MIC20XX's current-limiting circuitry, during current limiting, is designed to act as a constant current source to the load. As the load tries to pull more than the allotted current, V_{OUT} drops and the input to output voltage differential increases. When $V_{IN} - V_{OUT}$ exceeds 1V, I_{OUT} drops below I_{LIMIT} to reduce the drain of fault current on the system's power supply and to limit internal heating of the switch.

When measuring I_{OUT} it is important to bear this voltage dependence in mind, otherwise the measurement data may appear to indicate a problem when none really exists. This voltage dependence is illustrated in Figures 4 and 5.

In Figure 4, output current is measured as V_{OUT} is pulled below V_{IN} , with the test terminating when V_{OUT} is 1V below V_{IN} . Observe that once I_{LIMIT} is reached I_{OUT} remains constant throughout the remainder of the test. In Figure 5 this test is repeated but with $V_{IN} - V_{OUT}$ exceeding 1V.

When $V_{IN} - V_{OUT} > 1V$, switch's current limiting circuitry responds by decreasing I_{OUT} , as can be seen in Figure 5. In this demonstration, V_{OUT} is being controlled and I_{OUT} is the measured quantity. In real life applications V_{OUT} is determined in accordance with Ω 's law by the load and the limiting current.



Figure 5. I_{OUT} in Current Limiting for $V_{IN} - V_{OUT} > 1V$

This folding back of I_{LIMIT} can be generalized by plotting I_{LIMIT} as a function of V_{OUT} , as shown below in Figures 6 and 7. The slope of V_{OUT} between $I_{OUT} = 0V$ and $I_{OUT} = I_{LIMIT}$ (where $I_{LIMIT} = 1A$) is determined by R_{ON} of the switch and I_{LIMIT} .



Figure 4. I_{OUT} in Current Limiting for $V_{IN} - V_{OUT} < 1V$



Figure 6. Normalized Output Current vs. Output Voltage



Figure 7. Normalized Output Current vs. Output Voltage

C_{SLEW}

| | | | | | | |
|------|------|--------------|-------------|-------------|-------------|-------|
| 2003 | 2004 | 2005X | 2006 | 2007 | 2008 | 2009X |
| 2013 | 2014 | 2015 | 2016 | 2017 | 2018 | 2019X |

Only parts in **bold** have C_{SLEW} pin.
(Not available in 5-pin SOT-23 packages).

The C_{SLEW} pin is provided to increase control of the output voltage ramp at turn-on. This input allows designers the option of decreasing the output's slew rate (slowing the voltage rise) by adding an external capacitance between the C_{SLEW} and V_{IN} pins. This capacitance slows the rate at which the pass FET gate voltage increases and thus, slows both the response to an Enable command as well as V_{OUT}'s ascent to its final value.

Figure 8 illustrates effect of C_{SLEW} on turn-on delay and output rise time.



Figure 8. C_{SLEW} vs. Turn-On, Delay and Rise Times

C_{SLEW}'s Effect on I_{LIMIT}

An unavoidable consequence of adding C_{SLEW} capacitance is a reduction in the MIC20X5 – 20X8's ability to quickly limit current transients or surges. A sufficiently large capacitance can prevent both the primary and secondary current limits from acting in time to prevent damage to the MIC20X5 – 20X8 or the system from a short circuit fault. For this reason, the upper limit on the value of C_{SLEW} is 4nF.

Variable Undervoltage Lock Out (VUVLO)

| | | | | | | |
|------|------|-------|-------------|------|------|-------|
| 2003 | 2004 | 2005X | 2006 | 2007 | 2008 | 2009X |
| 2013 | 2014 | 2015 | 2016 | 2017 | 2018 | 2019X |

Only parts in **bold** have VUVLO pin and functionality.

Power-conscious systems, such as those implementing ACPI, will remain active even in their low-power states and may require the support of external devices through both phases of operation. Under these conditions, the current allowed these external devices may vary according to the system's operating state and as such require dual current limits on their peripheral ports. The MIC20X6 is designed for systems demanding two primary current limiting levels but without the use of a control signal to select between current limits.

To better understand how the MIC20X6 provides this, imagine a system whose main power supply supports heavy loads during normal operation, but in sleep mode is reduced to only few hundred milliamps of output current. In addition, this system has several USB ports which must remain active during sleep. During normal operation, each port can support a 500mA peripheral, but in sleep mode their combined output current is limited to what the power supply can deliver minus whatever the system itself is drawing.

If a peripheral device is plugged in which demands more current than is available, the system power supply will sag, or crash. The MIC20X6 prevents this by monitoring both the load current and V_{IN}. During normal operation, when the power supply can source plenty of current, the MIC20X6 will support any load up to its factory programmed current limit. When the weaker, standby supply is in operation, the MIC20X6 monitors V_{IN} and will shut off its output should V_{IN} dip below a predetermined value. This predetermined voltage is user programmable and set by the selection of the resistor divider driving the VUVLO pin.

To prevent false triggering of the VUVLO feature, the MIC20X6 includes a delay timer to blank out momentary excursions below the VUVLO trip point. If V_{IN} stays below the VUVLO trip point for longer than 32ms (typical), then the load is disengaged and the MIC20X6 will wait 128ms before reapplying power to the load. If V_{IN} remains below the VUVLO trip point, then the load will be powered for the 32ms blanking period and then again disengaged. This is illustrated in the scope plot below. If V_{IN} remains above the VUVLO trip point MIC20X6 resumes normal operation.



Figure 9. VUVLO Operation

VUVLO and Kickstart™ operate independently in the MIC2016. If the high-current surge allowed by Kickstart™ causes V_{IN} to dip below the VUVLO trip point for more than 32ms, VUVLO will disengage the load, even though the Kickstart™ timer has not timed out.



Figure 10. VUVLO Application Circuit

Calculating VUVLO Resistor Divider Values

The VUVLO feature is designed to keep the internal switch off until the voltage on the VUVLO pin is greater than 0.25V. A resistor divider network connected to the VUVLO and VIN pins is used to set the input trip voltage V_{TRIP} (see Figure 10). The value of R2 is chosen to minimize the load on the input supply I_{DIV} and the value of R1 sets the trip voltage V_{TRIP} .

The value of R2 is calculated using:

$$R2 = \frac{V_{VUVLO}}{I_{DIV}}$$

The value of R1 is calculated using:

$$R1 = R2 \times \left(\frac{V_{TRIP}}{V_{VUVLO}} - 1 \right)$$

Where for both equations:

$$V_{VUVLO} = 0.25V$$

When working with large value resistors, a small amount of leakage current from the VUVLO terminal can cause voltage offsets that degrade system accuracy. Therefore, the maximum recommended resistor value for R2 is 100kΩ.

Using the divider loading current I_{DIV} of 100μA, the value of R2 can be estimated by:

$$R2 = \frac{0.25V}{100\mu A} = 2.5k\Omega$$

Now the value of R1 can be calculated by:

$$R1 = 2.5k\Omega \times \left(\frac{4.75V}{0.25V} - 1 \right) = 45k$$

where:

$$V_{TRIP} = 4.75V \text{ (for a 5V supply)}$$

$$V_{VUVLO} = 0.25V$$

The VUVLO comparator uses no hysteresis. This is because the VUVLO blanking timer prevents any chattering that might otherwise occur if V_{IN} varies about the trigger point. The timer is reset by upward crossings of the trip point such that V_{IN} must remain below the trip point for the full 32ms period for load disengagement to occur.

In selecting a V_{TRIP} voltage, the designer is cautioned to not make this value less than 2.5V. A minimum of 2.5V is required for the MIC20X6's internal circuitry to operate properly. VUVLO trip points below 2.5V will result in erratic or unpredictable operation.

Kickstart™

| | | | | | | |
|-------------|-------------|-------------|-------------|-------------|-------------|--------------|
| 2003 | 2004 | 2005X | 2006 | 2007 | 2008 | 2009X |
| 2013 | 2014 | 2015 | 2016 | 2017 | 2018 | 2019X |

Only parts in **bold** have Kickstart™.
(Not available in 5-pin SOT-23 packages).

Kickstart™ allows brief current surges to pass to the load before the onset of normal current limiting, which permits dynamic loads to draw bursts of energy without sacrificing system safety.

Functionally, Kickstart™ is a forced override of the normal current limiting function provided by the switch. The Kickstart™ period is governed by an internal timer which allows current to pass up to the secondary current limit (I_{LIMIT_2nd}) to the load for 128ms and then normal (primary) current limiting goes into action.

During Kickstart™, a secondary current-limiting circuit is monitoring output current to prevent damage to the switch, as a hard short combined with a robust power supply can result in currents of many tens of amperes. This secondary current limit is nominally set at 4A and reacts immediately and independently of the Kickstart™ period. Once the Kickstart™ timer has finished its count the primary current limiting circuit takes over and holds I_{OUT} to its programmed limit for as long as the excessive load persists.

Once the switch drops out of current limiting the Kickstart™ timer initiates a lock-out period of 128ms such that no further bursts of current above the primary current limit, will be allowed until the lock-out period has expired.

Kickstart™ may be over-ridden by the thermal protection circuit and if sufficient internal heating occurs, Kickstart™ will be terminated and $I_{OUT} \rightarrow 0A$. Upon cooling, if the load is still present $I_{OUT} \rightarrow I_{LIMIT}$, not I_{LIMIT_2nd} .



Figure 11. Kickstart™

Automatic Load Discharge

| | | | | | | |
|------|-------------|-------|------|-------------|------|-------|
| 2003 | 2004 | 2005X | 2006 | 2007 | 2008 | 2009X |
| 2013 | 2014 | 2015 | 2016 | 2017 | 2018 | 2019X |

Only parts in **bold** have automatic load discharge.

Automatic discharge is a valuable feature when it is desirable to quickly remove charge from the V_{OUT} pin. This allows for a quicker power-down of the load. This also prevents any charge from being presented to a device being connected to the V_{OUT} pin, for example, USB, 1394, PCMCIA, and CableCARD™.

Automatic discharge is performed by a shunt MOSFET from V_{OUT} pin to GND. When the switch is disabled, a break before make action is performed turning off the main power MOSFET and then enabling the shunt MOSFET. The total resistance of the MOSFET and internal resistances is typically 126Ω.

Supply Filtering

A minimum 1μF bypass capacitor positioned close to the V_{IN} and GND pins of the switch is both good design practice and required for proper operation of the switch. This will control supply transients and ringing. Without a bypass capacitor, large current surges or a short may cause sufficient ringing on V_{IN} (from supply lead inductance) to cause erratic operation of the switch's control circuitry. For best-performance good quality, low-ESR capacitors are recommended, preferably ceramic.

When bypassing with capacitors of 10μF and up, it is good practice to place a smaller value capacitor in parallel with the larger to handle the high frequency components of any line transients. Values in the range of 0.01μF to 0.1μF are recommended. Again, good quality, low-ESR capacitors should be chosen.

Power Dissipation

Power dissipation depends on several factors such as the load, PCB layout, ambient temperature, and supply voltage. Calculation of power dissipation can be accomplished by the following equation:

$$P_D = R_{DS(ON)} \times (I_{OUT})^2$$

To relate this to junction temperature, the following equation can be used:

$$T_J = P_D \times R_{\theta(J-A)} + T_A$$

where:

T_J = junction temperature

T_A = ambient temperature

$R_{\theta(J-A)}$ is the thermal resistance of the package

In normal operation the switch's R_{ON} is low enough that no significant I^2R heating occurs. Device heating is most often caused by a short circuit, or very-heavy load, when a significant portion of the input supply voltage appears across the switch's power MOSFET. Under these conditions the heat generated will exceed the package and PCB's ability to cool the device and thermal limiting will be invoked.

In Figure 12, die temperature is plotted against I_{OUT} assuming a constant case temperature of 85°C. The plots also assume a worst case R_{ON} of 140mΩ at a die temperature of 135°C. Under these conditions it is clear that an SOT-23 packaged device will be on the verge of thermal shutdown, typically 140°C die temperature, when operating at a load current of 1.25A. For this reason we recommend using MLF[®] packaged switches for any design intending to supply continuous currents of 1A or more.



Figure 12. Die Temperature vs. I_{OUT}

Package Information

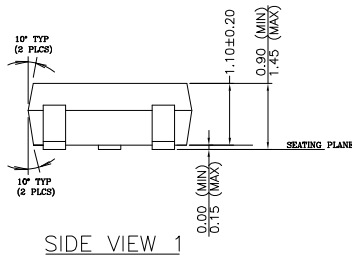
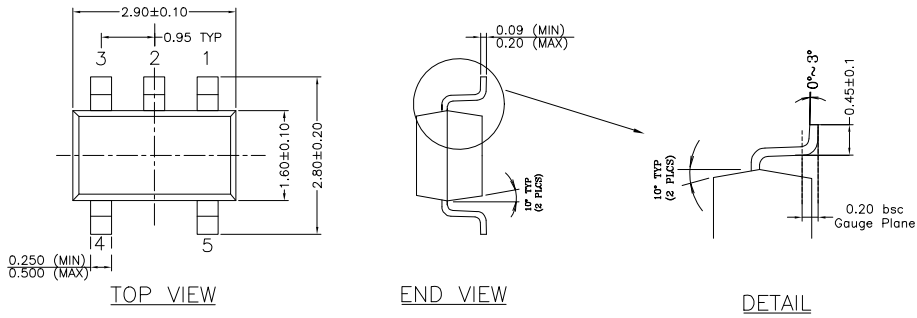

NOTE:
 1. PACKAGE OUTLINE EXCLUSIVE OF MOLD FLASH & BURR.
 2. PACKAGE OUTLINE INCLUSIVE OF SOLER PLATING.
 3. DIMENSION AND TOLERANCE PER ANSI Y14.5M, 1982.
 4. FOOT LENGTH MEASUREMENT BASED ON GAUGE PLANE METHOD.
 5. DIE FACES UP FOR MOLD, AND FACES DOWN FOR TRIM/FORM.
 6. ALL DIMENSIONS ARE IN MILLIMETERS.

5-Pin SOT-23 (M5)

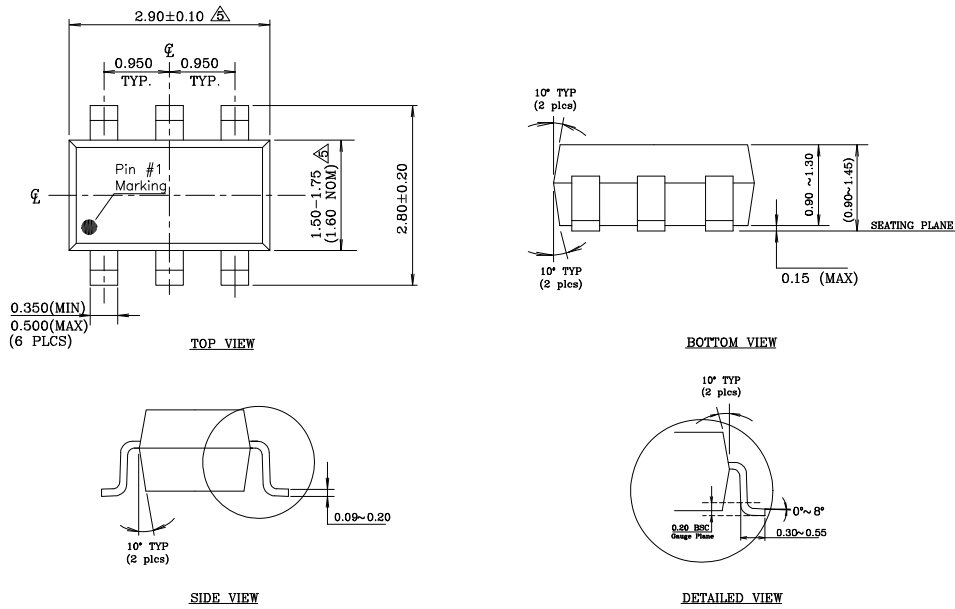

NOTE:
 1. Dimensions and tolerances are as per ANSI Y14.5M, 1982.
 2. Package surface to be mirror finish.
 3. Die is facing up for mold. Die is facing down for trim/form, ie. reverse trim/form.
 4. The footlength measuring is based on the gauge plane method.
 5. Dimension are exclusive of mold flash & gate burr.

6-Pin SOT-23 (M6)

Package Information (Continued)

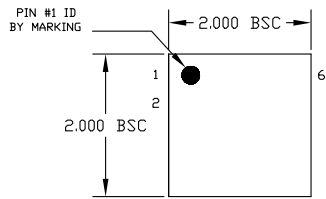

TOP VIEW

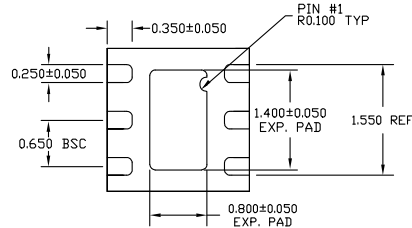

BOTTOM VIEW

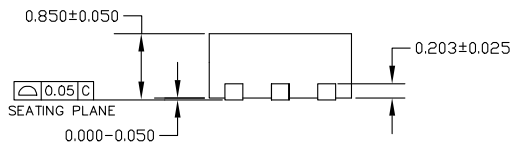

SIDE VIEW

- NOTE:
1. ALL DIMENSIONS ARE IN MILLIMETERS.
 2. MAX. PACKAGE WARPAGE IS 0.05 mm.
 3. MAXIMUM ALLOWABLE BURRS IS 0.076 mm IN ALL DIRECTIONS.
 4. PIN #1 ID ON TOP WILL BE LASER MARKED.

6 Pin 2mm x 2mm MLF® (ML)

Section 1.01 MICREL, INC. 2180 FORTUNE DRIVE SAN JOSE, CA 95131 USA
 TEL +1 (408) 944-0800 FAX +1 (408) 474-1000 WEB <http://www.micrel.com>

Micrel makes no representations or warranties with respect to the accuracy or completeness of the information furnished in this data sheet. This information is not intended as a warranty and Micrel does not assume responsibility for its use. Micrel reserves the right to change circuitry, specifications and descriptions at any time without notice. No license, whether express, implied, arising by estoppel or otherwise, to any intellectual property rights is granted by this document. Except as provided in Micrel's terms and conditions of sale for such products, Micrel assumes no liability whatsoever, and Micrel disclaims any express or implied warranty relating to the sale and/or use of Micrel products including liability or warranties relating to fitness for a particular purpose, merchantability, or infringement of any patent, copyright or other intellectual property right.

Micrel Products are not designed or authorized for use as components in life support appliances, devices or systems where malfunction of a product can reasonably be expected to result in personal injury. Life support devices or systems are devices or systems that (a) are intended for surgical implant into the body or (b) support or sustain life, and whose failure to perform can be reasonably expected to result in a significant injury to the user. A Purchaser's use or sale of Micrel Products for use in life support appliances, devices or systems is a Purchaser's own risk and Purchaser agrees to fully indemnify Micrel for any damages resulting from such use or sale.

© 2009 Micrel, Incorporated.