



LD2980ABxx LD2980Cxx

Ultra low drop voltage regulators compatible
with low ESR inhibit output capacitors

Features

- Stable with low ESR ceramic capacitors
- Ultra low dropout voltage (0.12 V typ. at 50 mA load, 7 mV typ. at 1 mA load)
- Very low quiescent current (80 μ A typ. at no load in on mode; max 1 μ A in off mode)
- Guaranteed output current up to 50 mA
- Logic-controlled electronic shutdown
- Output voltage of 1.8; 2.5; 3.0; 3.3; 3.6; 5.0 V
- Internal current and thermal limit
- $\pm 0.5\%$ Tolerance output voltage available (A version)
- Output low noise voltage 160 μ VRMS
- Temperature range: -40 to 125 $^{\circ}$ C
- Smallest package SOT23-5L and SOT-89
- Fast dynamic response to line and load changes

Description

The low drop-voltage and the ultra low quiescent current make them suitable for low noise, low power applications and in battery powered

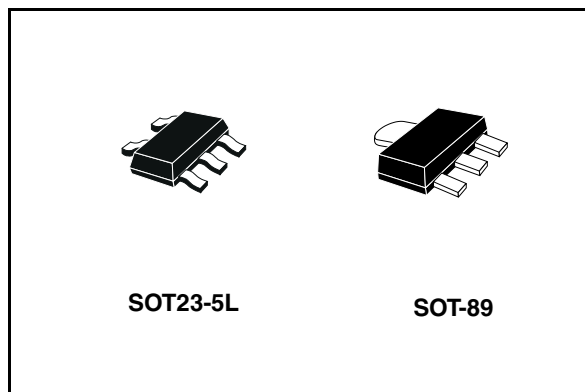

systems. The quiescent current in sleep mode is less than 1 μ A when the INHIBIT pin is pulled low. A shutdown logic control function is available on pin n $^{\circ}$ 3 (TTL compatible). This means that when the device is used as local regulator, it is possible to put a part of the board in standby, decreasing the total power consumption. The LD2980 is designed to work with low ESR ceramic capacitors. Typical applications are cellular phone, laptop computer, personal digital assistant (PDA), personal stereo, camcorder and camera.

Table 1. Device summary

Order codes				
AB Version		C Version		Output voltage
SOT23-5L	SOT-89	SOT23-5L	SOT-89	
		LD2980CM18TR	LD2980CU18TR	1.8 V
LD2980ABM25TR	LD2980ABU25TR ⁽¹⁾	LD2980CM25TR	LD2980CU25TR ⁽¹⁾	2.5 V
LD2980ABM30TR	LD2980ABU30TR ⁽¹⁾	LD2980CM30TR ⁽¹⁾	LD2980CU30TR ⁽¹⁾	3.0 V
LD2980ABM33TR	LD2980ABU33TR	LD2980CM33TR		3.3 V
LD2980ABM36TR	LD2980ABU36TR ⁽¹⁾	LD2980CM36TR	LD2980CU36TR ⁽¹⁾	3.6 V
LD2980ABM50TR	LD2980ABU50TR	LD2980CM50TR	LD2980CU50TR	5.0 V

1. Available on request.

Contents

1	Diagram	3
2	Pin configuration	4
3	Maximum ratings	5
4	Typical application	6
5	Electrical characteristics	7
6	Typical performance characteristics	11
7	Application notes	14
	7.1 External capacitors	14
	7.2 Input capacitor	14
	7.3 Output capacitor	14
	7.4 Important	14
	7.5 Inhibit input operation	14
	7.6 Reverse current	15
8	Package mechanical data	16
9	Revision history	21

1 Diagram

Figure 1. Schematic diagram

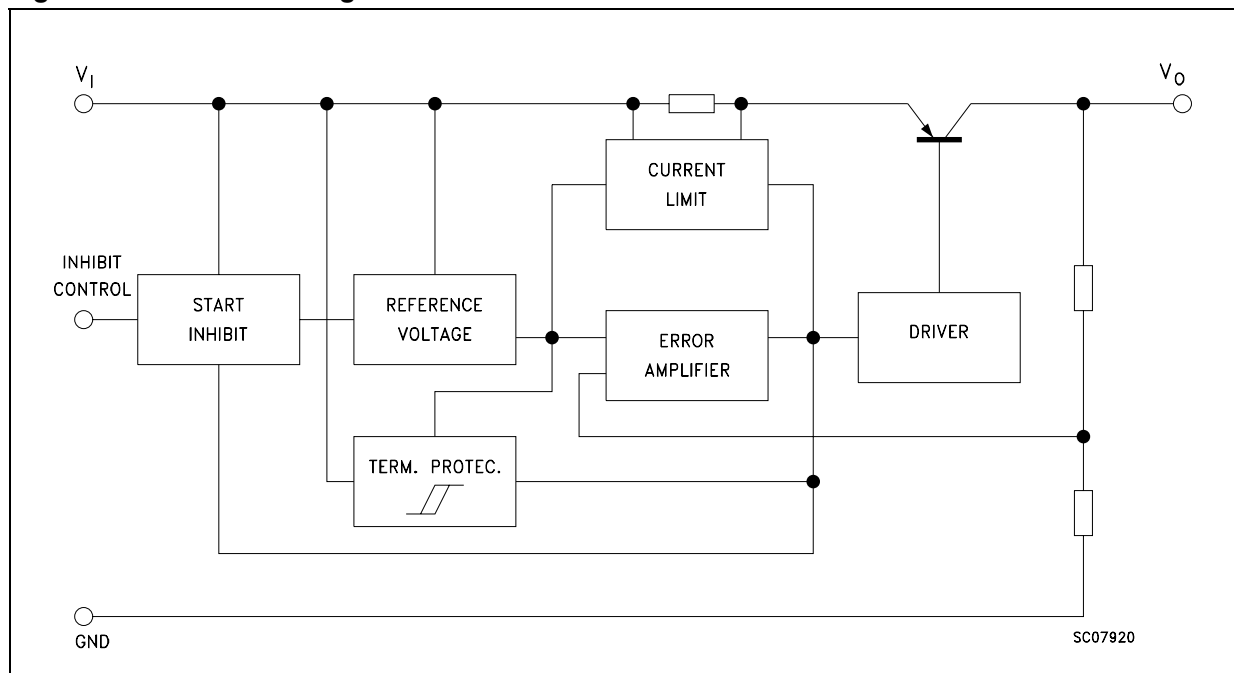

2 Pin configuration

Figure 2. Pin connections (top view)



Table 2. Pin description

Pin n° SOT23-5L	Pin n° SOT-89	Symbol	Name and Function
1	3	V_{IN}	Input port
2	2	GND	Ground pin
3		INHIBIT	Control switch ON/OFF. Inhibit is not internally pulled-up; it cannot be left floating. Disable the device when connected to GND or to a positive voltage less than 0.18 V
4		NC	Not connected
5	1	V_{OUT}	Output port

Table 3. Thermal data

Symbol	Parameter	SOT23-5L	SOT-89	Unit
R_{thJC}	Thermal resistance junction-case	81	15	°C/W
R_{thJA}	Thermal resistance junction-ambient	255	110	°C/W

3 Maximum ratings

Table 4. Absolute maximum ratings

Symbol	Parameter	Value	Unit
V_I	DC input voltage	-0.3 to 16	V
V_{INH}	INHIBIT input voltage	-0.3 to 16	V
I_O	Output current	Internally limited	
P_D	Power dissipation	Internally limited	
T_{STG}	Storage temperature range	-55 to 150	°C
T_{OP}	Operating junction temperature range	-40 to 125	°C

Note: Absolute maximum ratings are those values beyond which damage to the device may occur. Functional operation under these condition is not implied.

4 Typical application

Figure 3. Application circuit

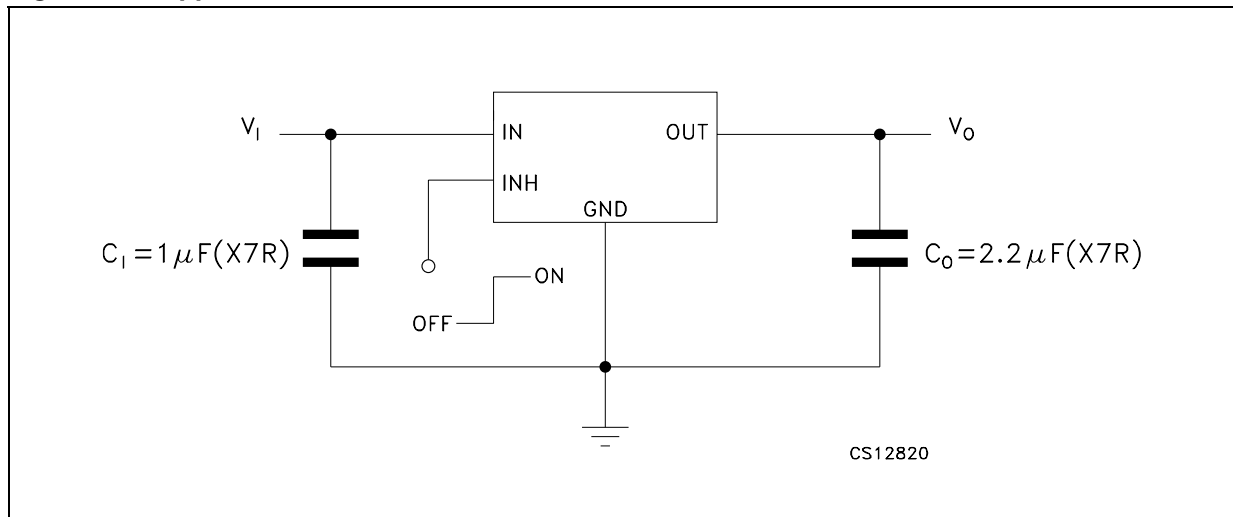

Note: *Inhibit pin is not internally pulled-up then it must not be left floating. Disable the device when connected to GND or to a positive voltage less than 0.18 V.*

5 Electrical characteristics

Table 5. Electrical characteristics for LD2980AB ($T_J = 25\text{ °C}$, $V_I = V_{O(NOM)} + 1\text{ V}$, $C_I = 1\text{ }\mu\text{F(X7R)}$, $C_O = 2.2\text{ }\mu\text{F (X7R)}$, $I_O = 1\text{ mA}$, $V_{INH} = 2\text{ V}$, unless otherwise specified).

Symbol	Parameter	Test conditions	Min.	Typ.	Max.	Unit
V_{OP}	Operating input voltage		2.5		16	V
V_O	Output voltage	$I_O = 1\text{ mA}$	2.487	2.5	2.513	V
		$I_O = 1\text{ to }50\text{ mA}$	2.481		2.519	
		$I_O = 1\text{ to }50\text{ mA}$, $T_J = -40\text{ to }125\text{ °C}$	2.437		2.562	
V_O	Output voltage	$I_O = 1\text{ mA}$	2.835	2.85	2.864	V
		$I_O = 1\text{ to }50\text{ mA}$	2.828		2.871	
		$I_O = 1\text{ to }50\text{ mA}$, $T_J = -40\text{ to }125\text{ °C}$	2.779		2.921	
V_O	Output voltage	$I_O = 1\text{ mA}$	2.985	3	3.015	V
		$I_O = 1\text{ to }50\text{ mA}$	2.978		3.023	
		$I_O = 1\text{ to }50\text{ mA}$, $T_J = -40\text{ to }125\text{ °C}$	2.925		3.075	
V_O	Output voltage	$I_O = 1\text{ mA}$	3.184	3.2	3.216	V
		$I_O = 1\text{ to }50\text{ mA}$	3.176		3.224	
		$I_O = 1\text{ to }50\text{ mA}$, $T_J = -40\text{ to }125\text{ °C}$	3.12		3.28	
V_O	Output voltage	$I_O = 1\text{ mA}$	3.284	3.3	3.317	V
		$I_O = 1\text{ to }50\text{ mA}$	3.275		3.325	
		$I_O = 1\text{ to }50\text{ mA}$, $T_J = -40\text{ to }125\text{ °C}$	3.217		3.383	
V_O	Output voltage	$I_O = 1\text{ mA}$	3.582	3.6	3.618	V
		$I_O = 1\text{ to }50\text{ mA}$	3.573		3.627	
		$I_O = 1\text{ to }50\text{ mA}$, $T_J = -40\text{ to }125\text{ °C}$	3.51		3.690	
V_O	Output voltage	$I_O = 1\text{ mA}$	3.781	3.8	3.819	V
		$I_O = 1\text{ to }50\text{ mA}$	3.772		3.829	
		$I_O = 1\text{ to }50\text{ mA}$, $T_J = -40\text{ to }125\text{ °C}$	3.705		3.895	
V_O	Output voltage	$I_O = 1\text{ mA}$	3.98	4	4.02	V
		$I_O = 1\text{ to }50\text{ mA}$	3.97		4.03	
		$I_O = 1\text{ to }50\text{ mA}$, $T_J = -40\text{ to }125\text{ °C}$	3.9		4.1	
V_O	Output voltage	$I_O = 1\text{ mA}$	4.677	4.7	4.724	V
		$I_O = 1\text{ to }50\text{ mA}$	4.665		4.735	
		$I_O = 1\text{ to }50\text{ mA}$, $T_J = -40\text{ to }125\text{ °C}$	4.582		4.818	
V_O	Output voltage	$I_O = 1\text{ mA}$	4.826	4.85	4.874	V
		$I_O = 1\text{ to }50\text{ mA}$	4.814		4.886	
		$I_O = 1\text{ to }50\text{ mA}$, $T_J = -40\text{ to }125\text{ °C}$	4.729		4.971	
V_O	Output voltage	$I_O = 1\text{ mA}$	4.975	5	5.025	V
		$I_O = 1\text{ to }50\text{ mA}$	4.963		5.038	
		$I_O = 1\text{ to }50\text{ mA}$, $T_J = -40\text{ to }125\text{ °C}$	4.875		5.125	
ΔV_O	Line regulation	$V_{O(NOM)} + 1 < V_{IN} < 16\text{ V}$, $I_O = 1\text{ mA}$		0.003	0.014	%V
		$T_J = -40\text{ to }125\text{ °C}$			0.032	

Table 5. Electrical characteristics for LD2980AB (continued) ($T_J = 25\text{ }^\circ\text{C}$, $V_I = V_{O(NOM)} + 1\text{ V}$, $C_I = 1\text{ }\mu\text{F}$ (X7R), $C_O = 2.2\text{ }\mu\text{F}$ (X7R), $I_O = 1\text{ mA}$, $V_{INH} = 2\text{ V}$, unless otherwise specified).

Symbol	Parameter	Test conditions	Min.	Typ.	Max.	Unit
I_Q	Quiescent current ON MODE	$I_O = 0$		80	100	μA
		$I_O = 0, T_J = -40\text{ to }125\text{ }^\circ\text{C}$			150	
		$I_O = 1\text{ mA}$		100	150	
		$I_O = 1\text{ mA}, T_J = -40\text{ to }125\text{ }^\circ\text{C}$			200	
		$I_O = 10\text{ mA}$		175	250	
		$I_O = 10\text{ mA}, T_J = -40\text{ to }125\text{ }^\circ\text{C}$			450	
		$I_O = 50\text{ mA}$		500	700	
		$I_O = 50\text{ mA}, T_J = -40\text{ to }125\text{ }^\circ\text{C}$			1200	
	OFF MODE	$V_{INH} < 0.18\text{ V}$		0		
		$V_{INH} < 0.18\text{ V}, T_J = -40\text{ to }125\text{ }^\circ\text{C}$				1
V_{DROPO}	Dropout voltage (<i>Note 1</i>)	$I_O = 0$		1	3	mV
		$I_O = 0, T_J = -40\text{ to }125\text{ }^\circ\text{C}$			5	
		$I_O = 1\text{ mA}$		7	10	
		$I_O = 1\text{ mA}, T_J = -40\text{ to }125\text{ }^\circ\text{C}$			15	
		$I_O = 10\text{ mA}$		40	60	
		$I_O = 10\text{ mA}, T_J = -40\text{ to }125\text{ }^\circ\text{C}$			90	
		$I_O = 50\text{ mA}$		120	150	
		$I_O = 50\text{ mA}, T_J = -40\text{ to }125\text{ }^\circ\text{C}$			225	
I_{SC}	Short circuit current	$R_L = 0$		150		mA
SVR	Supply voltage rejection	$C_O = 10\mu\text{F}$, $f = 1\text{ kHz}$		63		dB
V_{INH}	Inhibit input logic low	LOW = Output OFF, $T_J = -40\text{ to }125\text{ }^\circ\text{C}$		0.8	0.18	V
V_{INL}	Inhibit input logic high	HIGH = Output ON, $T_J = -40\text{ to }125\text{ }^\circ\text{C}$	1.6	1.3		V
I_{INH}	Inhibit input current	$V_{INH} = 0\text{ V}, T_J = -40\text{ to }125\text{ }^\circ\text{C}$		0	-1	μA
		$V_{INH} = 5\text{ V}, T_J = -40\text{ to }125\text{ }^\circ\text{C}$		5	15	
e_N	Output noise voltage	$B_W = 300\text{ Hz to }50\text{ kHz}$, $C_O = 10\mu\text{F}$		160		μV_{RMS}
T_{SHDN}	Thermal shutdown			170		$^\circ\text{C}$

Note: 1 For $V_O < 2.5\text{ V}$ dropout voltage can be calculated according to the minimum input voltage in full temperature range.

Table 6. Electrical characteristics for LD2980C ($T_J = 25\text{ }^\circ\text{C}$, $V_I = V_{O(NOM)} + 1\text{ V}$, $C_I = 1\text{ }\mu\text{F}$ (X7R), $C_O = 2.2\text{ }\mu\text{F}$ (X7R), $I_O = 1\text{ mA}$, $V_{INH} = 2\text{ V}$, unless otherwise specified)

Symbol	Parameter	Test conditions	Min.	Typ.	Max.	Unit
V_{OP}	Operating input voltage		2.5		16	V
V_O	Output voltage	$I_O = 1\text{ mA}$	1.478	1.5	1.522	V
		$I_O = 1\text{ to }50\text{ mA}$	1.470		1.530	
		$I_O = 1\text{ to }50\text{ mA}$, $T_J = -40\text{ to }125\text{ }^\circ\text{C}$	1.445		1.555	
V_O	Output voltage	$I_O = 1\text{ mA}$	1.782	1.8	1.818	V
		$I_O = 1\text{ to }50\text{ mA}$	1.773		1.827	
		$I_O = 1\text{ to }50\text{ mA}$, $T_J = -40\text{ to }125\text{ }^\circ\text{C}$	1.737		1.863	
V_O	Output voltage	$I_O = 1\text{ mA}$	2.475	2.5	2.525	V
		$I_O = 1\text{ to }50\text{ mA}$	2.463		2.538	
		$I_O = 1\text{ to }50\text{ mA}$, $T_J = -40\text{ to }125\text{ }^\circ\text{C}$	2.412		2.587	
V_O	Output voltage	$I_O = 1\text{ mA}$	2.822	2.85	2.879	V
		$I_O = 1\text{ to }50\text{ mA}$	2.807		2.893	
		$I_O = 1\text{ to }50\text{ mA}$, $T_J = -40\text{ to }125\text{ }^\circ\text{C}$	2.75		2.949	
V_O	Output voltage	$I_O = 1\text{ mA}$	2.97	3	3.03	V
		$I_O = 1\text{ to }50\text{ mA}$	2.955		3.045	
		$I_O = 1\text{ to }50\text{ mA}$, $T_J = -40\text{ to }125\text{ }^\circ\text{C}$	2.895		3.105	
V_O	Output voltage	$I_O = 1\text{ mA}$	3.168	3.2	3.232	V
		$I_O = 1\text{ to }50\text{ mA}$	3.152		3.248	
		$I_O = 1\text{ to }50\text{ mA}$, $T_J = -40\text{ to }125\text{ }^\circ\text{C}$	3.088		3.312	
V_O	Output voltage	$I_O = 1\text{ mA}$	3.267	3.3	3.333	V
		$I_O = 1\text{ to }50\text{ mA}$	3.251		3.35	
		$I_O = 1\text{ to }50\text{ mA}$, $T_J = -40\text{ to }125\text{ }^\circ\text{C}$	3.184		3.415	
V_O	Output voltage	$I_O = 1\text{ mA}$	3.564	3.6	3.636	V
		$I_O = 1\text{ to }50\text{ mA}$	3.546		3.654	
		$I_O = 1\text{ to }50\text{ mA}$, $T_J = -40\text{ to }125\text{ }^\circ\text{C}$	3.474		3.726	
V_O	Output voltage	$I_O = 1\text{ mA}$	3.76	3.8	3.838	V
		$I_O = 1\text{ to }50\text{ mA}$	3.743		3.857	
		$I_O = 1\text{ to }50\text{ mA}$, $T_J = -40\text{ to }125\text{ }^\circ\text{C}$	3.667		3.933	
V_O	Output voltage	$I_O = 1\text{ mA}$	3.96	4	4.04	V
		$I_O = 1\text{ to }50\text{ mA}$	3.94		4.06	
		$I_O = 1\text{ to }50\text{ mA}$, $T_J = -40\text{ to }125\text{ }^\circ\text{C}$	3.86		4.14	
V_O	Output voltage	$I_O = 1\text{ mA}$	4.653	4.7	4.747	V
		$I_O = 1\text{ to }50\text{ mA}$	4.630		4.771	
		$I_O = 1\text{ to }50\text{ mA}$, $T_J = -40\text{ to }125\text{ }^\circ\text{C}$	4.535		4.864	
V_O	Output voltage	$I_O = 1\text{ mA}$	4.802	4.85	4.899	V
		$I_O = 1\text{ to }50\text{ mA}$	4.777		4.923	
		$I_O = 1\text{ to }50\text{ mA}$, $T_J = -40\text{ to }125\text{ }^\circ\text{C}$	4.68		5.02	

Table 6. Electrical characteristics for LD2980C (continued) ($T_J = 25^\circ\text{C}$, $V_I = V_{O(NOM)} + 1\text{ V}$, $C_I = 1\ \mu\text{F}$ (X7R), $C_O = 2.2\ \mu\text{F}$ (X7R), $I_O = 1\ \text{mA}$, $V_{INH} = 2\ \text{V}$, unless otherwise specified)

Symbol	Parameter	Test conditions	Min.	Typ.	Max.	Unit
V_O	Output voltage	$I_O = 1\ \text{mA}$	4.95	5	5.05	V
		$I_O = 1\ \text{to}\ 50\ \text{mA}$	4.925		5.075	
		$I_O = 1\ \text{to}\ 50\ \text{mA}$, $T_J = -40\ \text{to}\ 125^\circ\text{C}$	4.825		5.175	
ΔV_O	Line regulation	$V_{O(NOM)} + 1 < V_{IN} < 16\ \text{V}$, $I_O = 1\ \text{mA}$		0.003	0.014	%V
		$T_J = -40\ \text{to}\ 125^\circ\text{C}$			0.032	
I_Q	Quiescent current ON MODE	$I_O = 0$		80	100	μA
		$I_O = 0$, $T_J = -40\ \text{to}\ 125^\circ\text{C}$			150	
		$I_O = 1\ \text{mA}$		100	150	
		$I_O = 1\ \text{mA}$, $T_J = -40\ \text{to}\ 125^\circ\text{C}$			200	
		$I_O = 10\ \text{mA}$		175	250	
		$I_O = 10\ \text{mA}$, $T_J = -40\ \text{to}\ 125^\circ\text{C}$			450	
		$I_O = 50\ \text{mA}$		500	700	
		$I_O = 50\ \text{mA}$, $T_J = -40\ \text{to}\ 125^\circ\text{C}$			1200	
	OFF MODE	$V_{INH} < 0.18\ \text{V}$		0		
		$V_{INH} < 0.18\ \text{V}$, $T_J = -40\ \text{to}\ 125^\circ\text{C}$			1	
V_{DROPP}	Dropout voltage (<i>Note 1</i>)	$I_O = 0$		1	3	mV
		$I_O = 0$, $T_J = -40\ \text{to}\ 125^\circ\text{C}$			5	
		$I_O = 1\ \text{mA}$		7	10	
		$I_O = 1\ \text{mA}$, $T_J = -40\ \text{to}\ 125^\circ\text{C}$			15	
		$I_O = 10\ \text{mA}$		40	60	
		$I_O = 10\ \text{mA}$, $T_J = -40\ \text{to}\ 125^\circ\text{C}$			90	
		$I_O = 50\ \text{mA}$		120	150	
		$I_O = 50\ \text{mA}$, $T_J = -40\ \text{to}\ 125^\circ\text{C}$			225	
I_{SC}	Short circuit current	$R_L = 0$		150		mA
SVR	Supply voltage rejection	$C_O = 10\ \mu\text{F}$, $f = 1\ \text{kHz}$		63		dB
V_{INH}	Inhibit input logic low	LOW = Output OFF, $T_J = -40\ \text{to}\ 125^\circ\text{C}$		0.8	0.18	V
V_{INL}	Inhibit input logic high	HIGH = Output ON, $T_J = -40\ \text{to}\ 125^\circ\text{C}$	1.6	1.3		V
I_{INH}	Inhibit input current	$V_{INH} = 0\ \text{V}$, $T_J = -40\ \text{to}\ 125^\circ\text{C}$		0	-1	μA
		$V_{INH} = 5\ \text{V}$, $T_J = -40\ \text{to}\ 125^\circ\text{C}$		5	15	
e_N	Output noise voltage	$B_W = 300\ \text{Hz}\ \text{to}\ 50\ \text{kHz}$, $C_O = 10\ \mu\text{F}$		160		μV_{RMS}
T_{SHDN}	Thermal shutdown			170		$^\circ\text{C}$

Note: 1 For $V_O < 2.5\ \text{V}$ dropout voltage can be calculated according to the minimum input voltage in full temperature range.

6 Typical performance characteristics

($T_J = 25\text{ }^\circ\text{C}$, $V_I = V_{O(NOM)} + 1\text{ V}$, $C_I = 1\text{ }\mu\text{F}$ (X7R), $C_O = 2.2\text{ }\mu\text{F}$ (X7R), $V_{INH} = 2\text{ V}$, unless otherwise specified)

Figure 4. Output voltage vs temperature

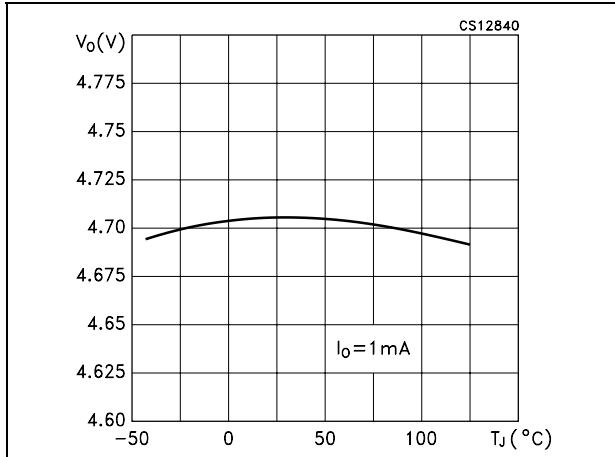

Figure 5. Output voltage vs temperature

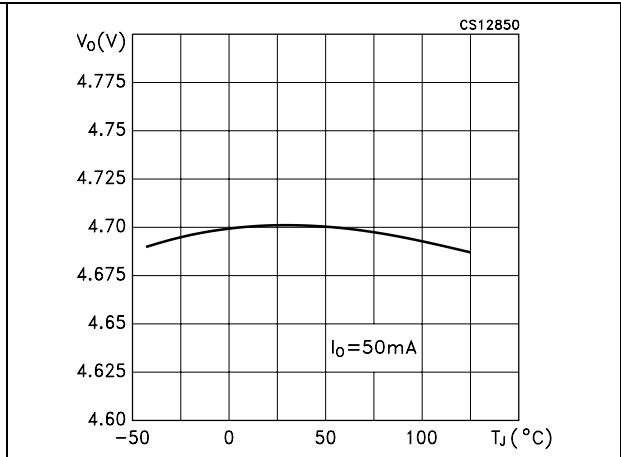

Figure 6. Line regulation vs temperature

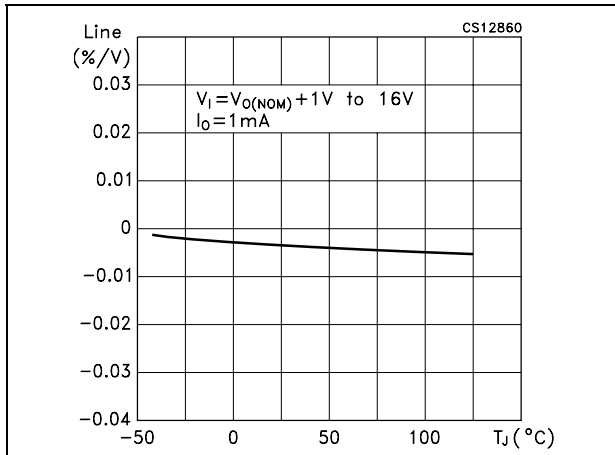

Figure 7. Load regulation vs temperature

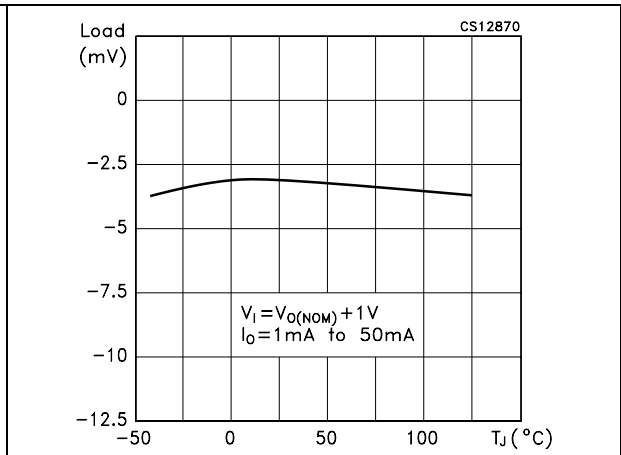

Figure 8. Dropout voltage vs temperature

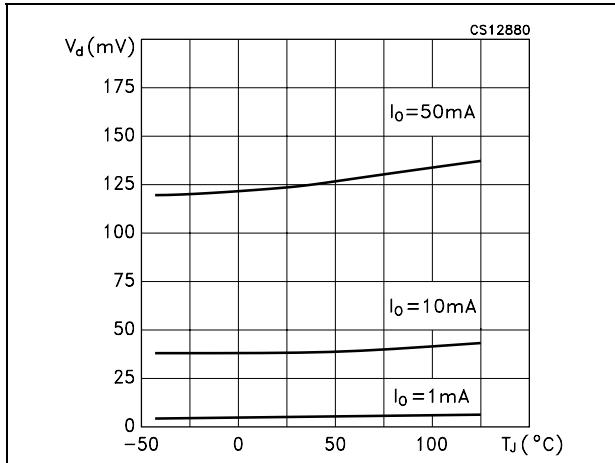

Figure 9. Quiescent current vs temperature

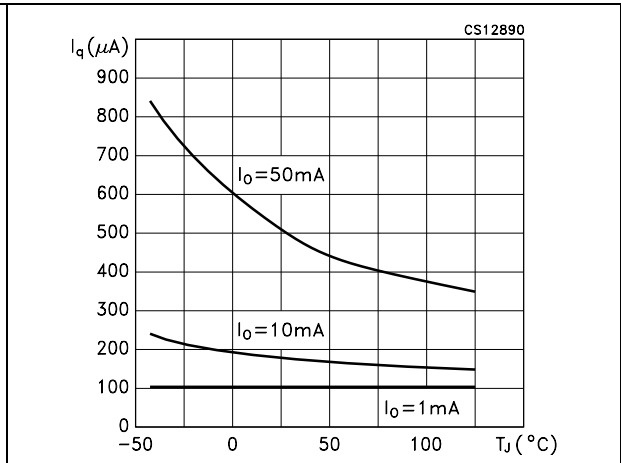

Figure 10. Quiescent current vs output current

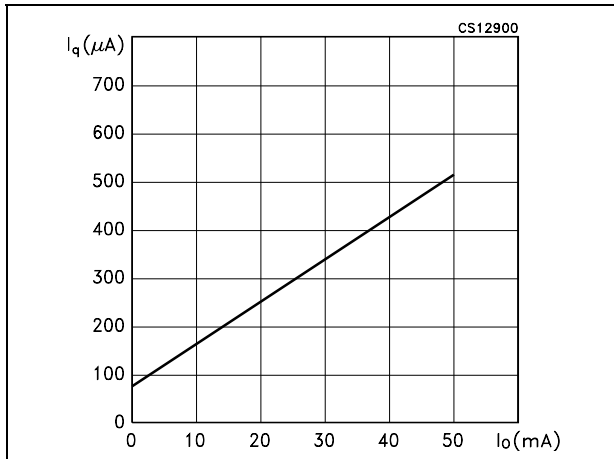

Figure 11. Off mode quiescent current vs temperature

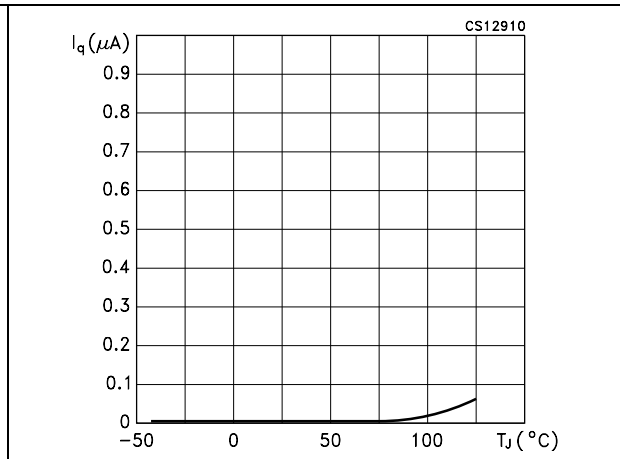

Figure 12. Quiescent current vs input voltage

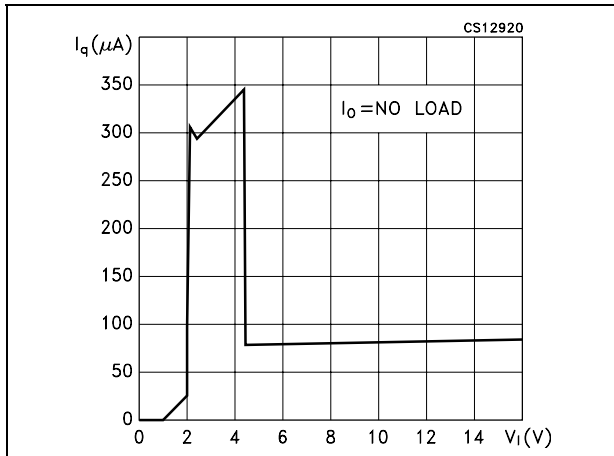

Figure 13. Dropout voltage vs output current

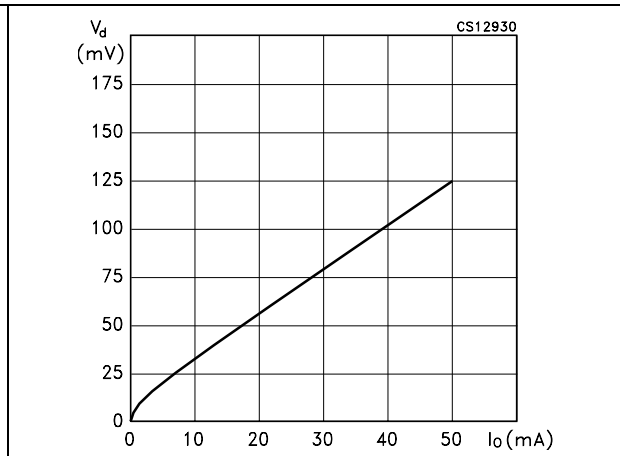

Figure 14. Inhibit input current vs temperature

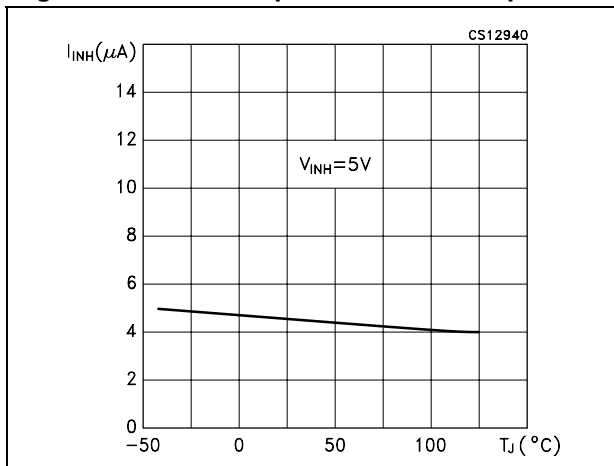

Figure 15. Inhibit voltage vs temperature

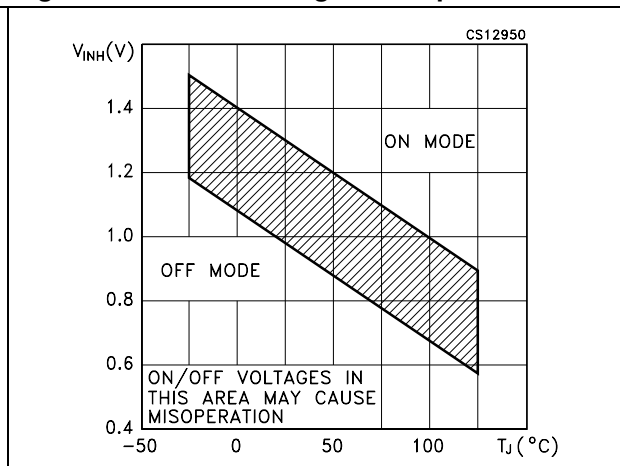

Figure 16. Supply voltage rejection vs frequency

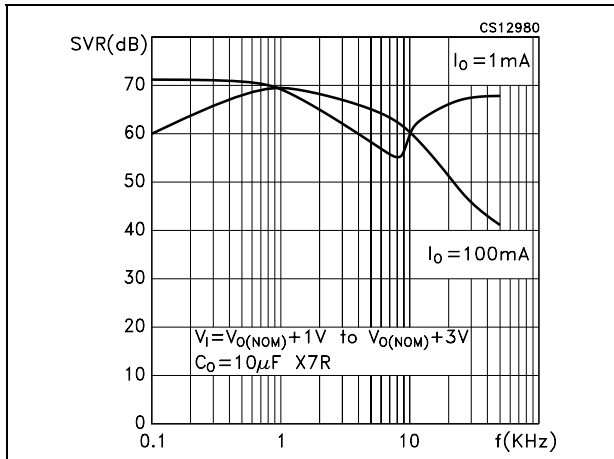

Figure 17. Noise voltage vs frequency

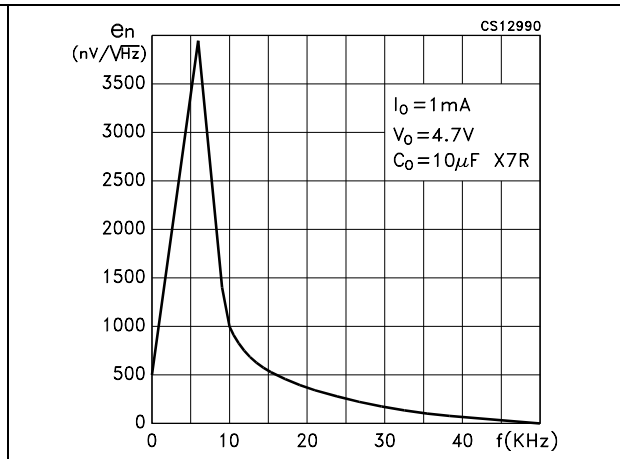

Figure 18. Best case: highest output version

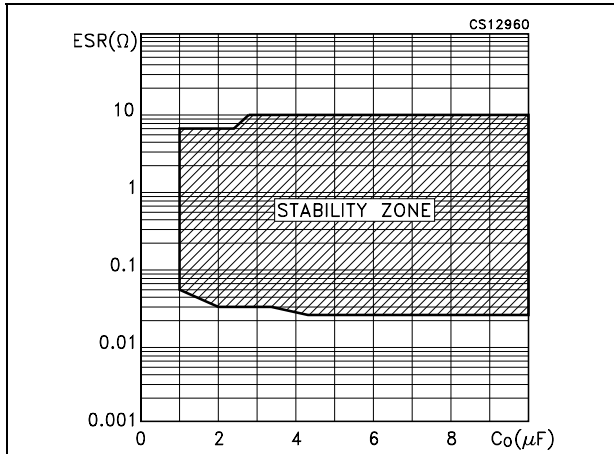

Figure 19. Worst case: lowest output version

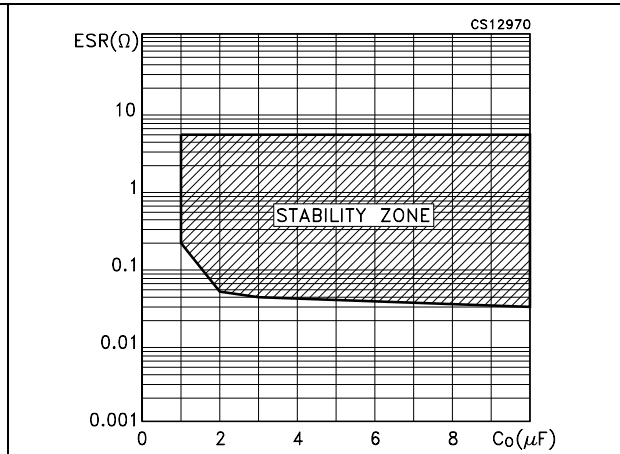

Figure 20. Load transient response

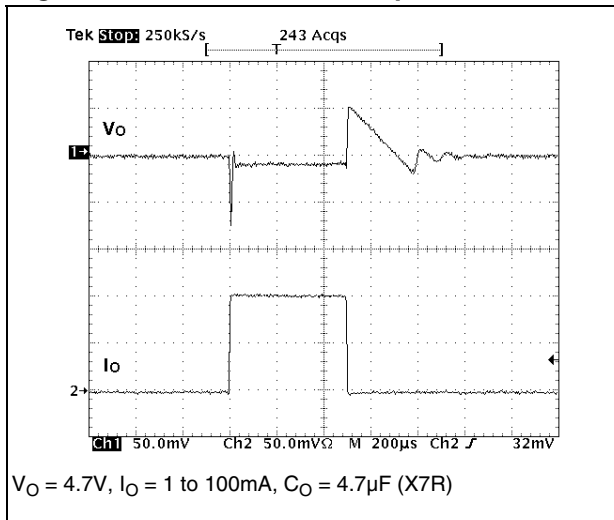
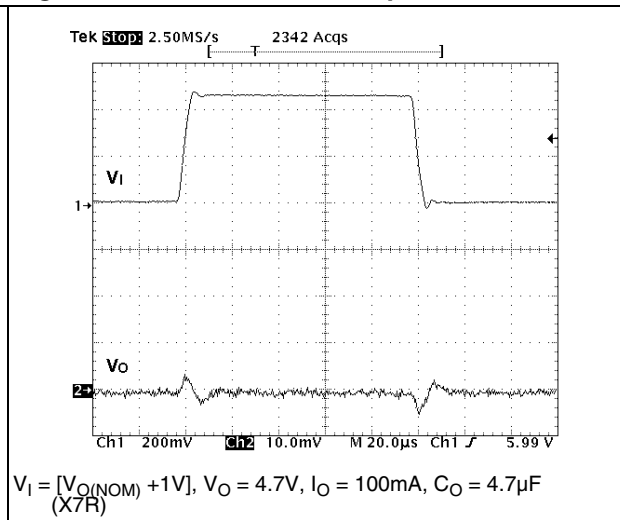

Figure 21. Line transient response



7 Application notes

7.1 External capacitors

Like any low-dropout regulator, the LD2980 requires external capacitors for regulator stability. This capacitor must be selected to meet the requirements of minimum capacitance and equivalent series resistance. We suggest to solder input and output capacitors as close as possible to the relative pins.

7.2 Input capacitor

An input capacitor whose value is 1 μF is required with the LD2980 (amount of capacitance can be increased without limit). This capacitor must be located a distance of not more than 0.5" from the input pin of the device and returned to a clean analog ground. Any good quality ceramic, tantalum or film capacitors can be used for this capacitor.

7.3 Output capacitor

The LD2980 is designed specifically to work with ceramic output capacitors. It may also be possible to use Tantalum capacitors, but these are not as attractive for reasons of size and cost. By the way, the output capacitor must meet both the requirement for minimum amount of capacitance and ESR (equivalent series resistance) value. The [Figure 4](#) and [Figure 5](#) show the allowable ESR range as a function of the output capacitance. These curves represent the stability region over the full temperature and I_O range. Due to the different loop gain, the stability improves for higher output versions and so the suggested minimum output capacitor value, if low ESR ceramic type is used, is 1 μF for output voltages equal or major than 3.8 V, 2.2 μF for output voltages from 2.85 to 3.3 V, and 3.3 μF for the other versions. However, if an output capacitor lower than the suggested one is used, it's possible to make stable the regulator adding a resistor in series to the capacitor (see [Figure 1](#) & [Figure 2](#) to choose the right value according to the used version and keeping in account that the ESR of ceramic capacitors has been measured @ 100 kHz).

7.4 Important

The output capacitor must maintain its ESR in the stable region over the full operating temperature to assure stability. Also, capacitor tolerance and variation with temperature must be considered to assure the minimum amount of capacitance is provided at all times. This capacitor should be located not more than 0.5" from the output pin of the device and returned to a clean analog ground.

7.5 Inhibit input operation

The inhibit pin can be used to turn OFF the regulator when pulled low, so drastically reducing the current consumption down to less than 1 μA . When the inhibit feature is not used, this pin must be tied to V_I to keep the regulator output ON at all times. To assure proper operation, the signal source used to drive the inhibit pin must be able to swing above and below the specified thresholds listed in the electrical characteristics section under V_{IH} V_{IL} . Any slew rate can be used to drive the inhibit.

7.6 Reverse current

The power transistor used in the LD2980 has not an inherent diode connected between the regulator input and output. If the output is forced above the input, no current will flow from the output to the input across the series pass transistor. When a V_{REV} voltage is applied on the output, the reverse current measured, according to the test circuit in [Figure 22](#), flows to the GND across the two feedback resistors. This current typical value is $160\ \mu\text{A}$. R_1 and R_2 resistors are implanted type; typical values are, respectively, $42.6\ \text{k}\Omega$ and $51.150\ \text{k}\Omega$

Figure 22. Reverse current test circuit

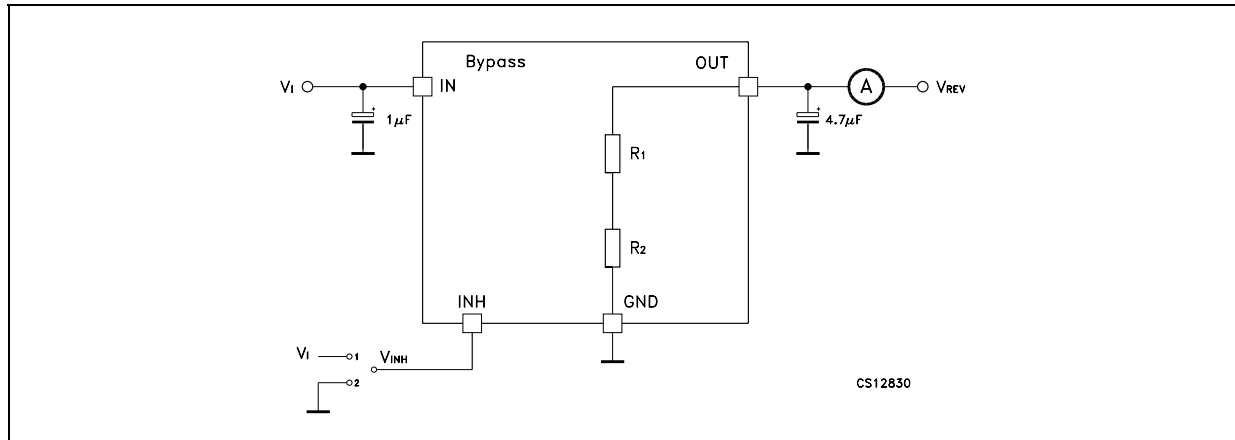

8 Package mechanical data

In order to meet environmental requirements, ST offers these devices in ECOPACK® packages. These packages have a lead-free second level interconnect. The category of second Level Interconnect is marked on the package and on the inner box label, in compliance with JEDEC Standard JESD97. The maximum ratings related to soldering conditions are also marked on the inner box label. ECOPACK is an ST trademark. ECOPACK specifications are available at: www.st.com.

SOT-89 mechanical data

Dim.	mm.			mils.		
	Min.	Typ.	Max.	Min.	Typ.	Max.
A	1.4		1.6	55.1		63.0
B	0.44		0.56	17.3		22.0
B1	0.36		0.48	14.2		18.9
C	0.35		0.44	13.8		17.3
C1	0.35		0.44	13.8		17.3
D	4.4		4.6	173.2		181.1
D1	1.62		1.83	63.8		72.0
E	2.29		2.6	90.2		102.4
e	1.42		1.57	55.9		61.8
e1	2.92		3.07	115.0		120.9
H	3.94		4.25	155.1		167.3
L	0.89		1.2	35.0		47.2

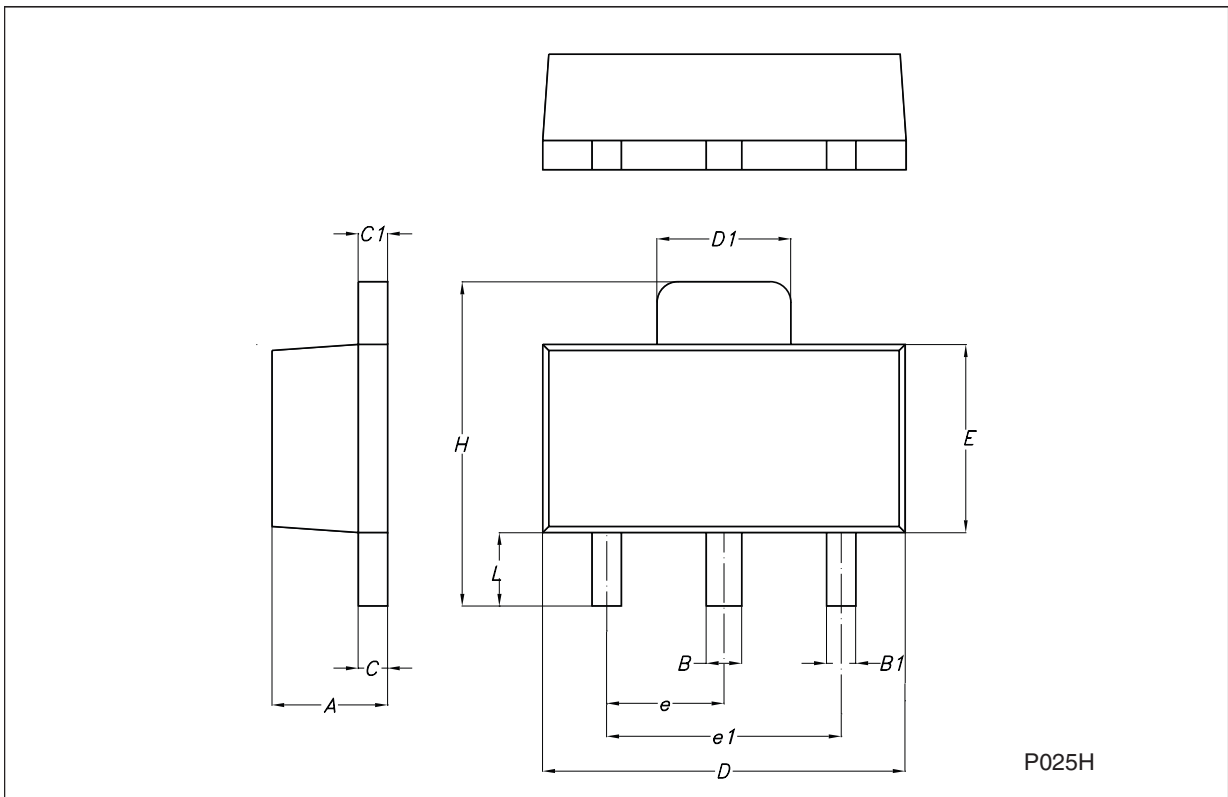

SOT23-5L mechanical data

Dim.	mm.			mils.		
	Min.	Typ.	Max.	Min.	Typ.	Max.
A	0.90		1.45	35.4		57.1
A1	0.00		0.10	0.0		3.9
A2	0.90		1.30	35.4		51.2
b	0.35		0.50	13.7		19.7
C	0.09		0.20	3.5		7.8
D	2.80		3.00	110.2		118.1
E	1.50		1.75	59.0		68.8
e		0.95			37.4	
H	2.60		3.00	102.3		118.1
L	0.10		0.60	3.9		23.6

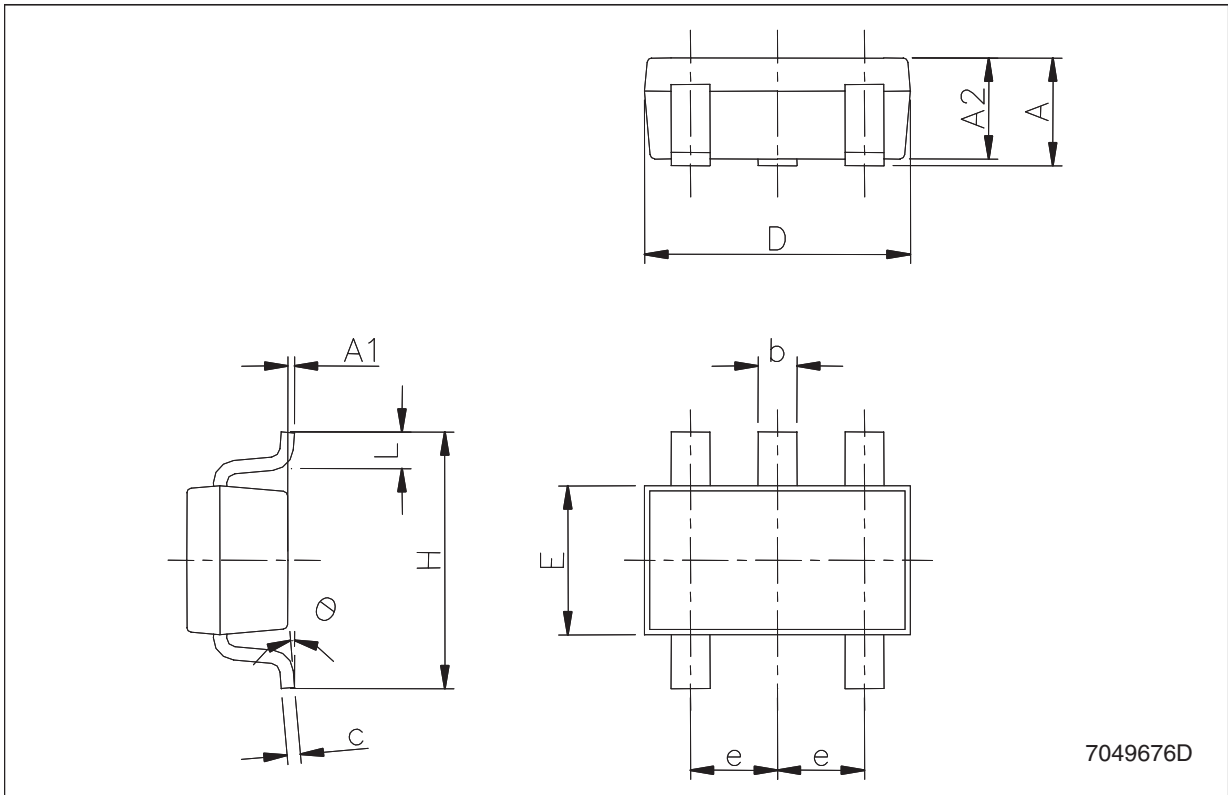

Tape & reel SOT23-xL mechanical data

Dim.	mm.			inch.		
	Min.	Typ.	Max.	Min.	Typ.	Max.
A			180			7.086
C	12.8	13.0	13.2	0.504	0.512	0.519
D	20.2			0.795		
N	60			2.362		
T			14.4			0.567
Ao	3.13	3.23	3.33	0.123	0.127	0.131
Bo	3.07	3.17	3.27	0.120	0.124	0.128
Ko	1.27	1.37	1.47	0.050	0.054	0.058
Po	3.9	4.0	4.1	0.153	0.157	0.161
P	3.9	4.0	4.1	0.153	0.157	0.161

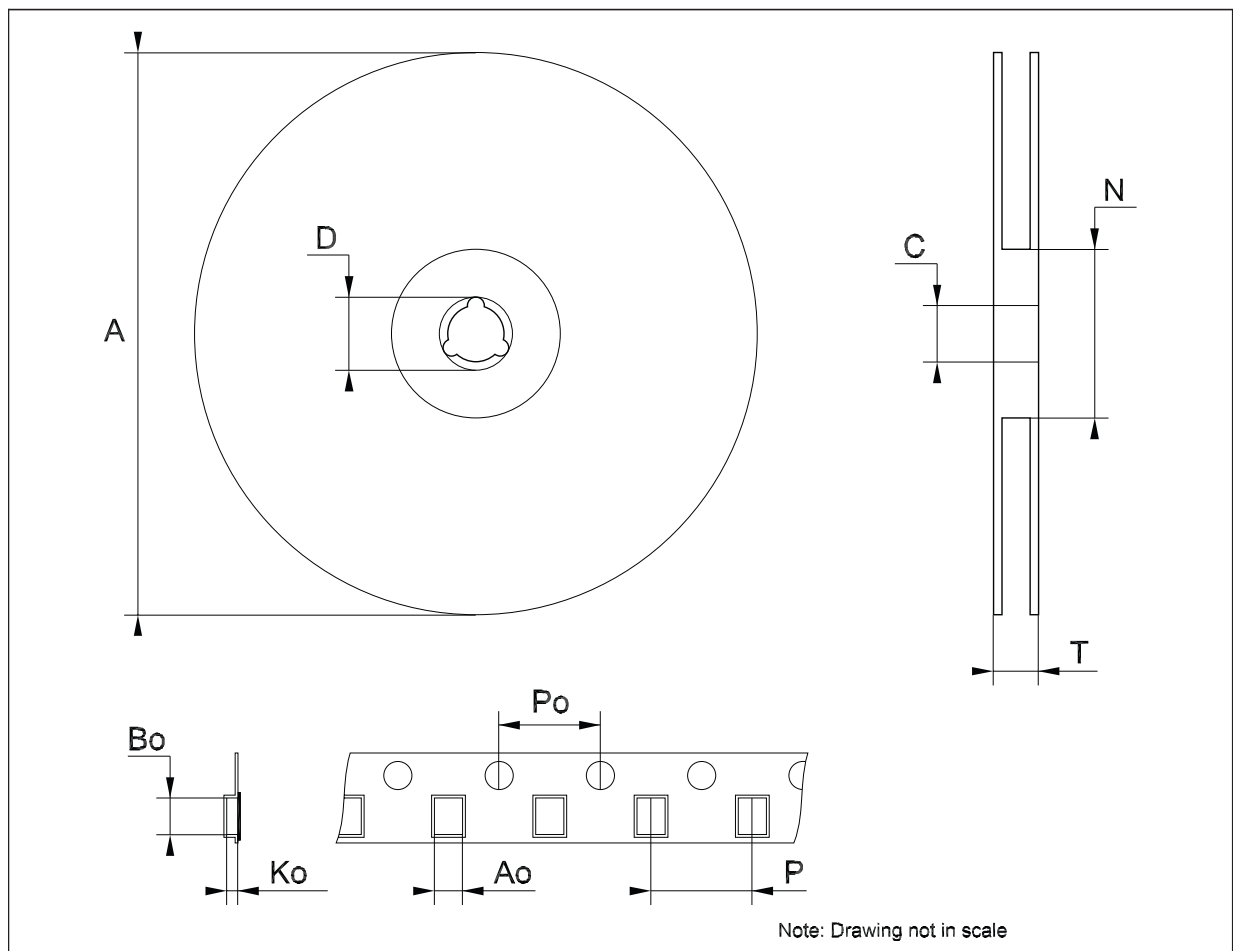

Tape & reel SOT89 mechanical data

Dim.	mm.			inch.		
	Min.	Typ.	Max.	Min.	Typ.	Max.
A			180			7.086
C	12.8	13.0	13.2	0.504	0.512	0.519
D	20.2			0.795		
N	60			2.362		
T			14.4			0.567
Ao	4.70	4.80	4.90	0.185	0.189	0.193
Bo	4.30	4.40	4.50	0.169	0.173	0.177
Ko	1.70	1.80	1.90	0.067	0.071	0.075
Po	3.9	4.0	4.1	0.153	0.157	0.161
P	7.9	8.0	8.1	0.311	0.315	0.319

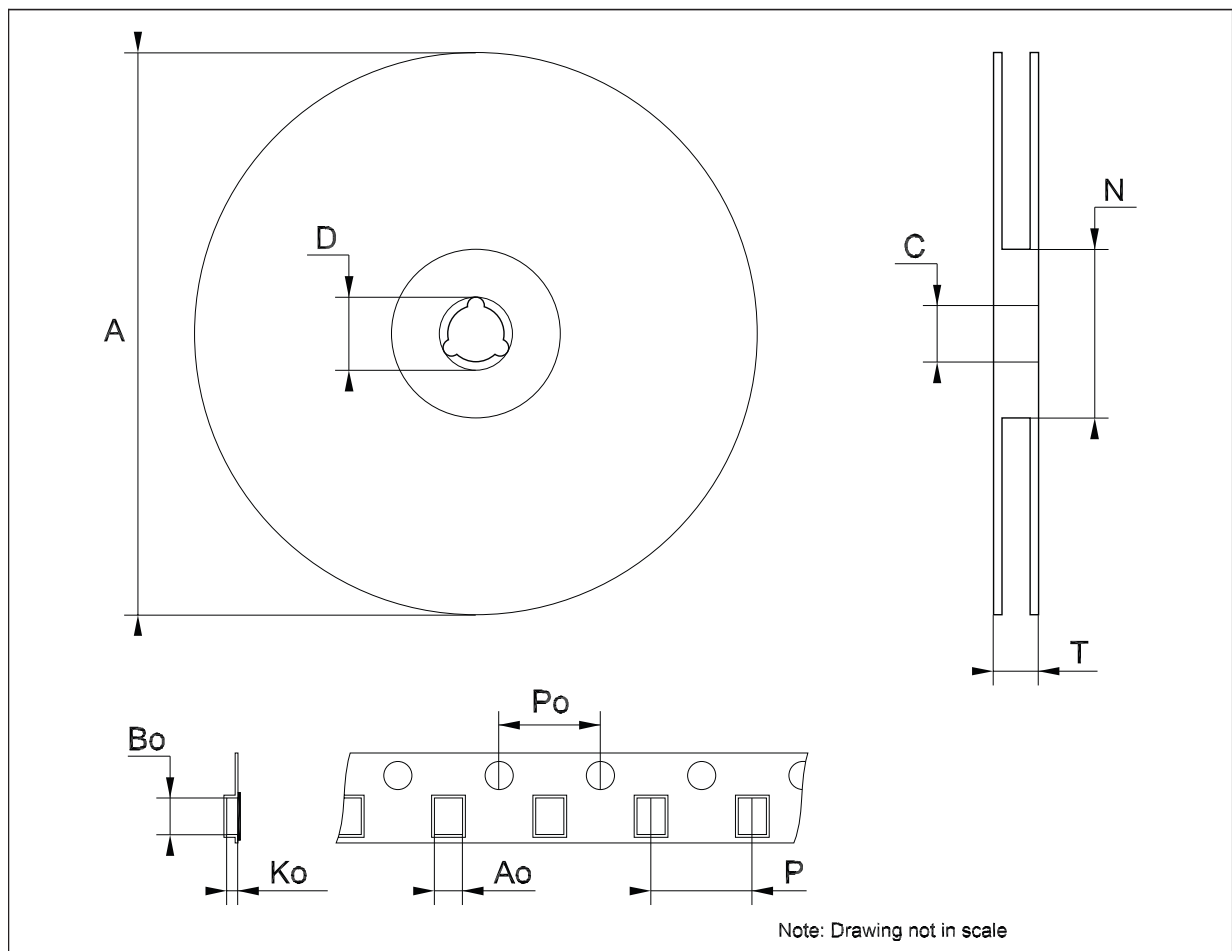

9 Revision history

Table 7. Document revision history

Date	Revision	Changes
03-Jul-2006	13	Order codes updated and new template.
13-Nov-2006	14	Add part number LD2980ABU18TR.
06-Sep-2007	15	Add Table 1 on page 1 .
14-Feb-2008	16	Modified: Table 1 on page 1 .

Please Read Carefully:

Information in this document is provided solely in connection with ST products. STMicroelectronics NV and its subsidiaries ("ST") reserve the right to make changes, corrections, modifications or improvements, to this document, and the products and services described herein at any time, without notice.

All ST products are sold pursuant to ST's terms and conditions of sale.

Purchasers are solely responsible for the choice, selection and use of the ST products and services described herein, and ST assumes no liability whatsoever relating to the choice, selection or use of the ST products and services described herein.

No license, express or implied, by estoppel or otherwise, to any intellectual property rights is granted under this document. If any part of this document refers to any third party products or services it shall not be deemed a license grant by ST for the use of such third party products or services, or any intellectual property contained therein or considered as a warranty covering the use in any manner whatsoever of such third party products or services or any intellectual property contained therein.

UNLESS OTHERWISE SET FORTH IN ST'S TERMS AND CONDITIONS OF SALE ST DISCLAIMS ANY EXPRESS OR IMPLIED WARRANTY WITH RESPECT TO THE USE AND/OR SALE OF ST PRODUCTS INCLUDING WITHOUT LIMITATION IMPLIED WARRANTIES OF MERCHANTABILITY, FITNESS FOR A PARTICULAR PURPOSE (AND THEIR EQUIVALENTS UNDER THE LAWS OF ANY JURISDICTION), OR INFRINGEMENT OF ANY PATENT, COPYRIGHT OR OTHER INTELLECTUAL PROPERTY RIGHT.

UNLESS EXPRESSLY APPROVED IN WRITING BY AN AUTHORIZED ST REPRESENTATIVE, ST PRODUCTS ARE NOT RECOMMENDED, AUTHORIZED OR WARRANTED FOR USE IN MILITARY, AIR CRAFT, SPACE, LIFE SAVING, OR LIFE SUSTAINING APPLICATIONS, NOR IN PRODUCTS OR SYSTEMS WHERE FAILURE OR MALFUNCTION MAY RESULT IN PERSONAL INJURY, DEATH, OR SEVERE PROPERTY OR ENVIRONMENTAL DAMAGE. ST PRODUCTS WHICH ARE NOT SPECIFIED AS "AUTOMOTIVE GRADE" MAY ONLY BE USED IN AUTOMOTIVE APPLICATIONS AT USER'S OWN RISK.

Resale of ST products with provisions different from the statements and/or technical features set forth in this document shall immediately void any warranty granted by ST for the ST product or service described herein and shall not create or extend in any manner whatsoever, any liability of ST.

ST and the ST logo are trademarks or registered trademarks of ST in various countries.

Information in this document supersedes and replaces all information previously supplied.

The ST logo is a registered trademark of STMicroelectronics. All other names are the property of their respective owners.

© 2008 STMicroelectronics - All rights reserved

STMicroelectronics group of companies

Australia - Belgium - Brazil - Canada - China - Czech Republic - Finland - France - Germany - Hong Kong - India - Israel - Italy - Japan - Malaysia - Malta - Morocco - Singapore - Spain - Sweden - Switzerland - United Kingdom - United States of America

www.st.com