



IQS232 Datasheet - Configurable 2 Channel sensor with Compensation for Sensitivity Reducing Objects

Unparalleled Features:

- Sub 4 μ A current consumption
- Automatic tuning for optimal operation in various environments & compensation against sensitivity reducing objects

The IQS232 ProxSense® IC is a fully integrated two channel capacitive contact and proximity sensor with market leading sensitivity and automatic tuning of the sense electrodes. The IQS232 provides a minimalist implementation requiring as few as 2 external components. The device is ready for use in a large range of applications while programming options allow customisation in specialised applications.

Main features:

- 2 Channel input device
- Differentiated Touch and Distributed Proximity Electrode
- ATI: Automatic tuning to optimum sensitivity
- Supply Voltage 1.8 V to 3.6 V
- Internal voltage regulator and reference capacitor
- OTP options available
- Direct (logic level) and serial data output
- Low Power Modes (sub 4 μ A min)
- Adjustable Proximity & Touch Thresholds
- Automatic drift compensation
- Development and Programming tools available
- Small and cost effective SO-8 package

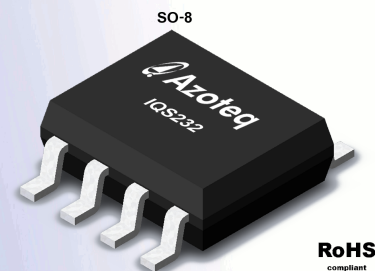

Applications:

- White goods and appliances
- Remote Controls
- Office equipment, toys, sanitary ware
- Flame proof, hazardous environment Human Interface Devices
- Proximity detection that enables back lighting activation (Patented)
- Wake-up from standby applications
- Replacement for electro mechanical switches

- GUI trigger on proximity detection.



Contents

List of Figures	3
List of Tables	3
Revision History	3
List of Symbols	4
1 Functional Overview	5
1.1 Pin Outs	5
1.2 Applicability	6
2 Analogue Functionality	6
3 Digital Functionality	6
4 Reference Design	7
4.1 Power Supply and PCB Layout	7
4.2 Design Rules for Harsh EMC Environments	8
5 High Sensitivity	9
6 User Configurable Options	9
6.1 Configuring of Devices	9
7 Description of User Options	15
7.1 ATI Method	15
7.2 Touch Base Values	15
7.3 Touch Thresholds	15
7.4 Proximity Threshold	15
7.5 Halt time	16
7.6 Proximity Base Value	16
7.7 Sensitivity Multipliers	16
7.8 Base Multipliers	16
7.9 Base Select	16
7.10 Charge Transfer Frequency	17
7.11 Streaming mode	17
7.12 Noise Detect	17
7.13 Low Power Mode	18
7.14 Guard Channel	19
7.15 Output Logic Select	19
7.16 ATI Delay	19
7.17 ATI Target	19
8 Charge Transfers	20
9 Auto Tuning Implementation	21
9.1 Full ATI	21
9.2 Partial ATI	22
10 Specifications	23



11 Mechanical Dimensions	25
12 Device Marking	28
13 Ordering Information	28
14 Contact Information	29
15 Memory Map	30
References	33

List of Figures

1.1 IQS232 pin-out.	5
4.1 IQS232 Reference Design.	7
4.2 EMC Design Choices.	8
7.1 LP Modes: Charge cycles.	19
8.1 Charge Transfer for IQS232.	20
11.1 SO 8 Package	25
11.2 SO 8 Footprint.	26
11.3 SO 8 Silk Screen.	26

List of Tables

1.1 IQS232 Pin-outs	5
6.1 User Selectable Configuration Options: Bank 0	10
6.2 User Selectable Configuration Options: Bank 1 (Full ATI)	11
6.3 User Selectable Configuration Options: Bank 1 (Partial ATI)	12
6.4 User Selectable Configuration Options: Bank 2	13
6.5 User Selectable Configuration Options: Bank 3	14
7.1 Distributed proximity channel's base values.	17
7.2 IQS232 Low Power Mode Timings	18
10.1 IQS232 General Operating Conditions	23
10.2 Start-up and shut-down slope Characteristics	23
10.3 POUT and TOUT Characteristics for each I/O	23
10.4 Initial Touch Times	24
10.5 Repetitive Touch Rates	24
11.1 SO-8 Package Dimensions.	25
11.2 SO 8 Footprint Dimensions	26
11.3 SO-8 Silk Screen Dimensions	27

Revision History

Rev	Description	Date
0.01	Preliminary	March 2012
1.00	First Release	June 2012



List of Symbols

ATI	Auto Tuning Implementation	5
BP	Boost Power Mode	18
CH	Channel	20
CS	Count(s)	15
CX	Sensor Electrode	5
EMI	Electromagnetic Interference	7
ESD	Electro-Static Discharge	7
FTB/EFT	(Electrical) Fast Transient Bursts	7
GND	Ground	5
LP	Low Power Mode	18
LTA	Long Term Average	15
ND	Noise Detect	13
NP	Normal Power Mode	18
OTP	One-time Programmable	9
P	Proximity	16
PO	Proximity Output	5
prox	Proximity Event	16
RDY	Ready	5
RF	Radio Frequency	5
SCL	I ² C Clock	5
SDA	I ² C Data	5
t	Time	11
THR	Threshold	10
TO	Touch Output	5
VDDHI	Supply (input) Voltage	5
VREG	Internal Regulator Output	5

1 Functional Overview

The IQS232 is a two channel capacitive proximity and touch sensor featuring an internal voltage regulator and reference capacitor (Cs). The device has two dedicated input pins for the connection of the sense electrodes (CX). Two output pins for Touch (for each channel) detection and one output (PO) for proximity detection. The output pins can be configured as Logic outputs or in a serial data streaming option on TO0 (data) and TO1 (clock). The device automatically tracks slow varying environmental changes via various filters, detect noise and has an automatic Auto Tuning Implementation (ATI) to tune the device for optimal sensitivity.

1.1 Pin Outs

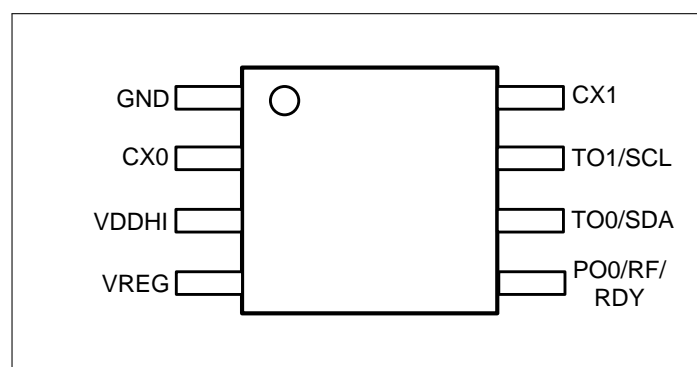

Figure 1.1: IQS232 pin-out.

The IQS232 is pin compatible with the IQS132, but has different electrical characteristics. Refer to Section 10.

Table 1.1: IQS232 Pin-outs

Pin	Stand Alone	Streaming	Function
1	GND	GND	Ground
2	CX0	CX0	Sense Electrode
3	VDDHI	VDDHI	Power Input
4	VREG	VREG	Regulator Pin
5	PO/RF	RDY/RF	Proximity Output
6	TO0	SDA	Touch Output
7	TO1	SCL	Touch Output
8	CX1	CX1	Sense Electrode





1.2 Applicability

All specifications, except where specifically mentioned otherwise, provided by this datasheet are applicable to the following ranges:

- Temperature -40°C to $+85^{\circ}\text{C}$
- Supply voltage (VDDHI) 1.8 V to 3.6 V

- Detection of PROX and TOUCH events.
- Managing outputs of the device.
- Managing serial communications.
- Manage programming of OTP options.

2 Analogue Functionality

The analogue circuitry measures the capacitance of the sense electrodes attached to the Cx pins through a charge transfer process that is periodically initiated by the digital circuitry. The measuring process is referred to as a conversion and consists of the discharging of Cs and Cx, the charging of Cx and then a series of charge transfers from Cx to Cs until a trip voltage is reached. The number of charge transfers required to reach the trip voltage is referred to as the counts (CS). The capacitance measurement circuitry makes use of an internal Cs and voltage reference (V_{REF}). The analogue circuitry further provides functionality for:

- Power on reset (POR) detection.
- Brown out detection (BOD).

3 Digital Functionality

The digital processing functionality is responsible for:

- Device configuration from OTP settings after POR.
- Management of BOD and WDT events.
- Initiation of conversions at the selected rate.
- Processing of CS and execution of algorithms.
- Monitoring and automatic execution of the ATI algorithm.
- Signal processing and digital filtering.

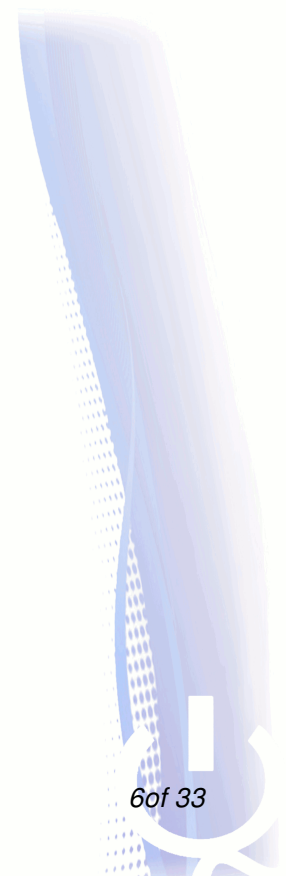

4 Reference Design

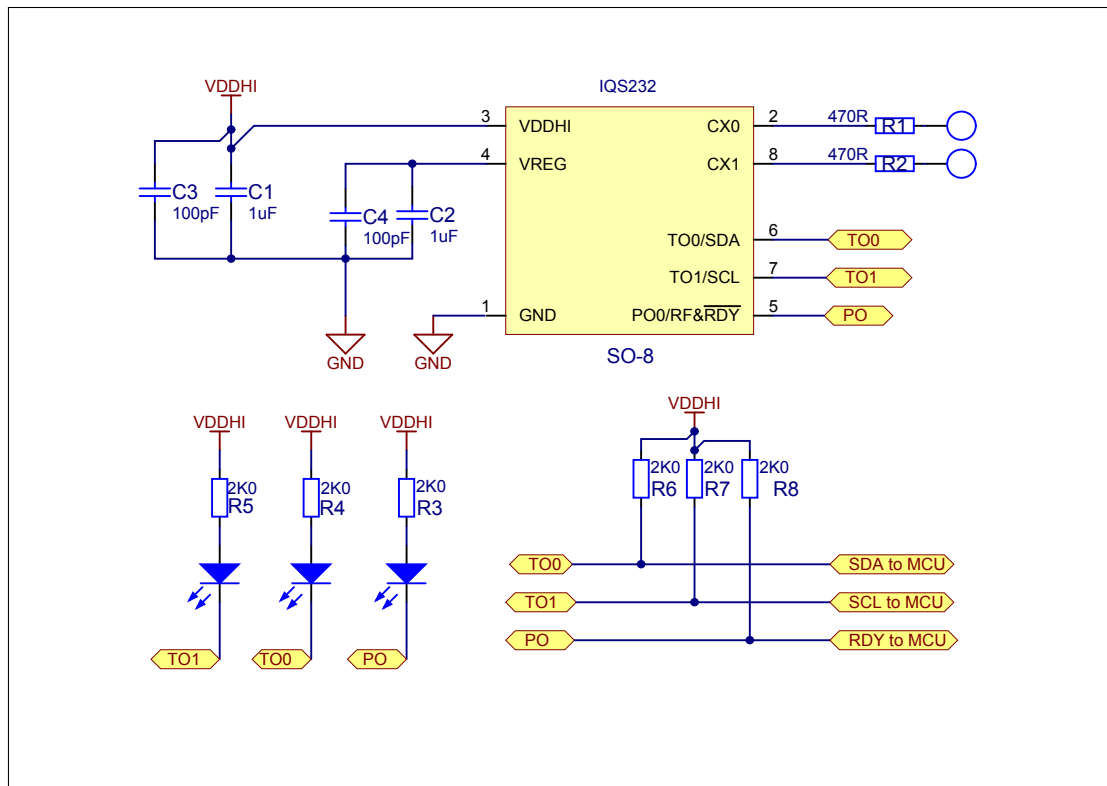

Figure 4.1: IQS232 Reference Design.

4.1 Power Supply and PCB Layout

Azoteq IC's provide a high level of on-chip hardware and software noise filtering and ESD protection (refer to Section 10). Designing PCB's with better noise immunity against EMI, FTB and ESD in mind, it is always advisable to keep the critical noise suppression components like the de-coupling capacitors and series resistors in Figure 4.1 as close as possible to the IC. Always maintain a good ground connection and ground pour underneath the IC. For more guidelines please refer to the relevant application notes as mentioned in Section 4.2.





4.2 Design Rules for Harsh EMC Environments

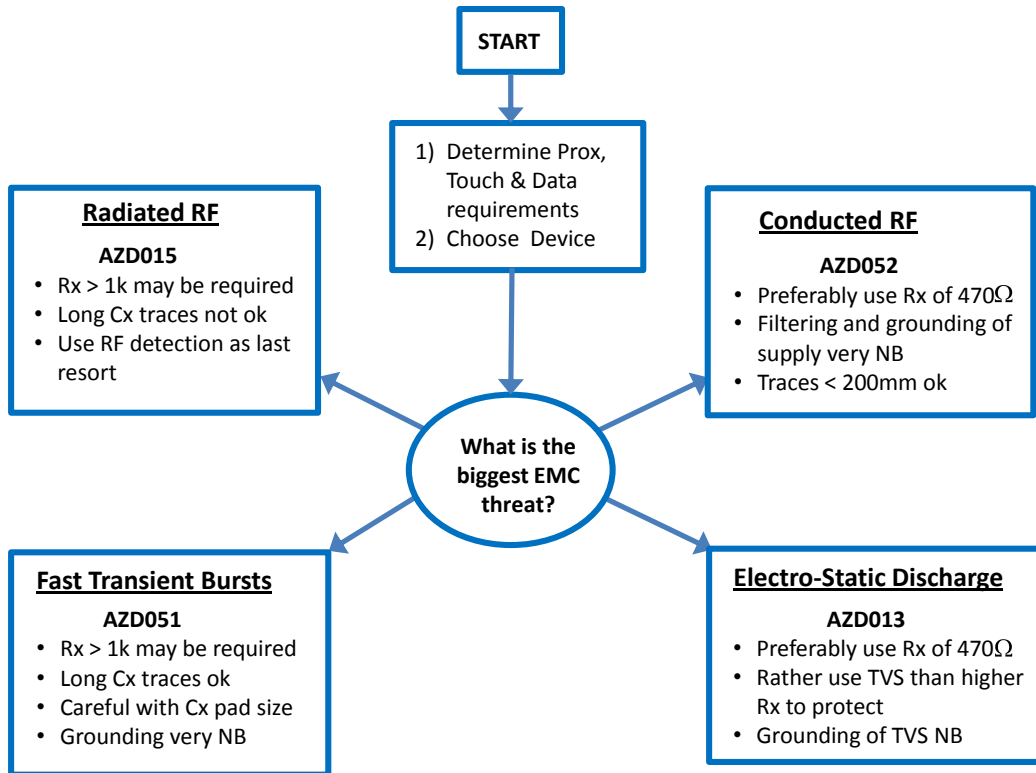

Figure 4.2: EMC Design Choices. Applicable application notes: [1], [2], [3], [4]





5 High Sensitivity

Through patented design and advanced signal processing, the device is able to provide extremely high sensitivity to detect proximity. This enables designs to detect proximity at distances that cannot be equalled by most other products. When the device is used in environments where high levels of noise exist, a reduced proximity threshold is proposed to ensure reliable functioning of the sensor. When the capacitance between the sense electrode and ground becomes too large the sensitivity of the device may be influenced. For more guidelines on layout, please refer to [5], available on the Azoteq web page, visit:

www.azoteq.com

the Azoteq website. Alternate programming solutions of the IQS232 also exist. For further enquiries regarding this matter please contact Azoteq at:

ProxSenseSupport@azoteq.com or the local distributor.

6 User Configurable Options

The IQS232 provides One Time Programmable (OTP) user options (each option can be modified only once). The IQS232 can enter streaming mode (I²C debugging) at start-up where the OTP options can be set and evaluated through the memory map, refer to Section 15, before programming OTP setting for stand alone use. The device is fully functional in the default (unconfigured) state. OTP options are intended for specific applications. The configuration of the device can be done on packaged devices or in-circuit. In-circuit configuration may be limited by values of external components chosen.

6.1 Configuring of Devices

Azoteq offers a Configuration Tool (CT220 or later) and accompanying software (USBProg.exe) that can be used to program the OTP user options for prototyping purposes. More details regarding the configuration of the device with the USBProg program is explained by [6]: "AZD007 - USBProg Overview" which can be found on





Table 6.1: User Selectable Configuration Options: Bank 0

ATI	Sys Use	BASE _{TCH}	T _{THR2}	T _{THR1}	T _{THR0}	P _{THR1}	P _{THR0}
bit 7	Bank 0						bit 0
Bank 0: bit 7	ATI:ATI method						Section 7.1
	0 = Full 1 = Partial						
Bank 0: bit 6	System Use						
Bank 0: bit 5	BASE_{TCH}: ATI Base Value for Touch Channels						Section 7.2
	0 = 250 (Less Sensitive) 1 = 100 (More Sensitive)						
Bank 0: bit 4:2	T_{THR2}:T_{THR1}: Touch Thresholds (CH2 independent)						Section 7.3
	000 = 4/64 001 = 1/64 (Most Sensitive) 010 = 2/64 011 = 8/64 100 = 12/64 101 = 16/64 110 = 24/64 111 = 32/64 (Least Sensitive)						
Bank 0: bit 4:2	P_{THR1}:P_{THR1}: Proximity Threshold						Section 7.4
	00 = 4 01 = 2 (Most Sensitive) 10 = 8 11 = 16 (Least Sensitive)						

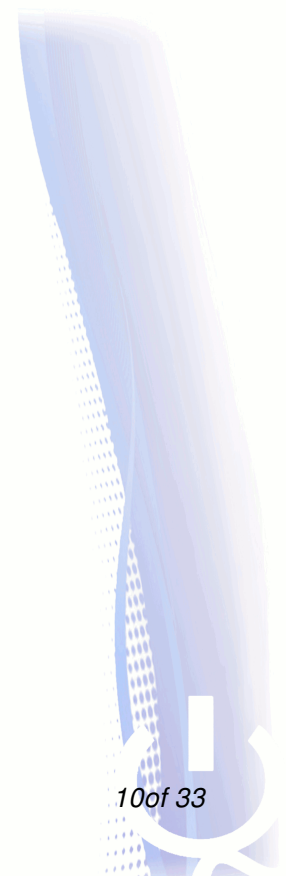



Table 6.2: User Selectable Configuration Options: Bank 1 (Full ATI)

t_{HALT1}	t_{HALT0}	Sys Use	T_{THR2}	T_{THR1}	T_{THR0}	BASE1	BASE0
bit 7	Bank 1 - Full ATI						bit 0
Bank 1: bit 7:6	t_{HALT1}:t_{HALT0}: Halt time of Long Term Average						Section 7.5
	00 = 20 seconds 01 = 40 seconds 10 = Never 11 = Always (Prox on 40)						
Bank 1: bit 5	System Use						
Bank 1: bit 4:2	CH2 T_{THR2}:T_{THR0}: Touch Thresholds on CH2						Section 7.3
	000 = 4/64 001 = 1/64 (Most Sensitive) 010 = 2/64 011 = 8/64 100 = 12/64 101 = 16/64 110 = 24/64 111 = 32/64 (Least Sensitive)						
Bank 1: bit 1:0	BASE1:BASE0: Proximity (CH0) Base Value						Section 7.6
	00 = 200 (150 with BASESEL set to Alternative) 01 = 50 (350 with BASESEL set to Alternative) 10 = 100 (500 with BASESEL set to Alternative) 11 = 250 (700 with BASESEL set to Alternative)						





Table 6.3: User Selectable Configuration Options: Bank 1 (Partial ATI)

t_{HALT1}	t_{HALT0}	MUL5	MUL4	MUL3	MUL2	MUL1	MUL0
bit 7	Bank 1 - Partial ATI						bit 0

Bank 1: bit 7:6	t_{HALT1}:t_{HALT0}: Halt time of Long Term Average	Section 7.5
	00 = 20 seconds 01 = 40 seconds 10 = Never 11 = Always (Prox on 40)	
Bank 1: bit 5:4	MUL5:MUL4: Sensitivity Multipliers	Section 7.7
	00 = Lowest 11 = Highest	
Bank 1: bit 3:0	MUL3:MUL0: Base Multipliers	Section 7.8
	0000 = Lowest 1111 = Highest	

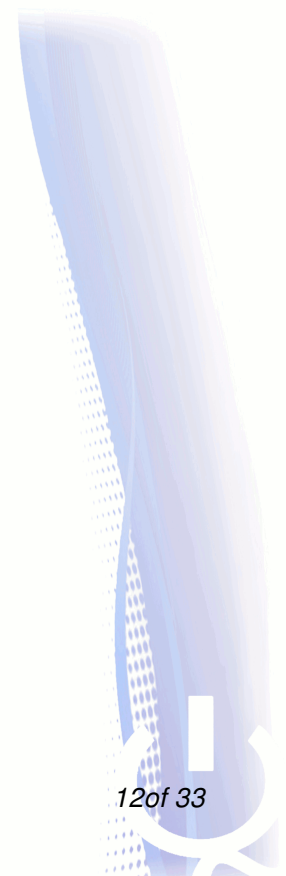



Table 6.4: User Selectable Configuration Options: Bank 2

Base_{SEL}	T_{FRQ}	STREAMING	ND	PMODE1	PMODE0	CX1 Block	LOGIC
bit 7	Bank 2						bit 0
Bank 2: bit 7	Base_{SEL}: Base Select						Section 7.9
	0 = Default 1 = Alternative						
Bank 2: bit 6	T_{FRQ}: Charge Transfer Frequency						Section 7.10
	0 = 250kHz 1 = 1MHz						
Bank 2: bit 5	STREAMING: 2-wire Streaming mode						Section 7.11
	0 = Disabled 1 = Enabled						
Bank 2: bit 4	ND: Noise Detect						Section 7.12
	0 = Disabled 1 = Enabled						
Bank 2: bit 3:2	PMODE1:PMODE0: Low Power Mode						Section 7.13
	00 = 9ms (Boost Power Mode) 01 = 32ms (Normal Power Mode) 10 = 128ms (Low Power 1) 11 = 1s (Low Power 2)						
Bank 2: bit 1	CX1 Block: Guard channel enable						Section 7.14
	0 = Disabled 1 = Enabled						
Bank 2: bit 0	LOGIC: Output logic select						Section 7.15
	0 = Active Low 1 = Active High						





Table 6.5: User Selectable Configuration Options: Bank 3

Sys Use	Sys Use	Sys Use	Sys Use	Sys Use	Sys Use	Delay	Target
bit 7	Bank 3						bit 0
Bank 3: bit 7:2	Sys Use: System Use						
Bank 3: bit 1	Delay: ATI Delay After Prox cleared						Section 7.16
	0 = 0 seconds 1 = 10 seconds						
Bank 3: bit 0	Target: ATI Target Counts						Section 7.17
	0 = Proximity Channel - 1024; Touch Channels - 512 1 = Proximity Channel - 512; Touch Channels - 256						

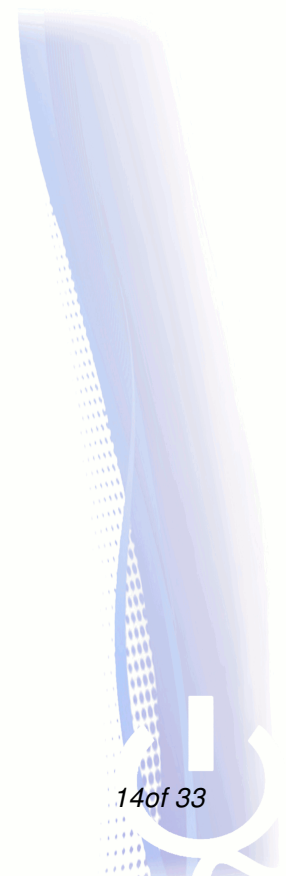



7 Description of User Options

This section describes the individual user programmable options of the IQS232 in more detail. Azoteq can supply pre-configured devices for large quantities.

Thresholds and other settings can also be evaluated in Test Mode streaming without programming the OTP options. For appropriate software, visit www.azoteq.com

7.1 ATI Method

The IQS232 can be setup to start in two ways; Full ATI and Partial ATI. In Full ATI mode, the device automatically select the multipliers through the ATI algorithm to setup the IQS232 as close as possible to its default sensitivity for the environment where it was placed. The designer can, however, select Partial ATI, and set the multipliers to a pre configured value. This will cause the IQS232 to only calculate the compensation (not the compensation and multipliers as in Full ATI), which allows the freedom to make the IQS232 more or less sensitive for its intended environment of use.

7.2 Touch Base Values

The IQS232 has the option to change the Base Values of the touch channels during the ATI algorithm. Depending on the application, this provides the user with another option to select the sensitivity of the touch channels (along with the touch thresholds, charge transfer frequency and the target counts) without changes in the hardware (CX sizes and routing, etc) The default Base Value 250, and can be set to 100 to increase the sensitivity. The Base Value cannot be changed independently for each channel.

7.3 Touch Thresholds

The IQS232 has 8 touch threshold settings. The touch threshold is selected by the designer to obtain the desired touch sensitivity. The touch threshold is expressed as a fraction of the LTA as follows:

$$T_{TH} = SelectedValue \times LTA \quad (7.1)$$

Where LTA is the Long Term Average The touch event is triggered based on T_{THR} , CS and LTA. A touch event is identified when for at least 2 consecutive samples of the following equation holds:

$$T_{THR} = < LTA - CS \quad (7.2)$$

With lower average CS (therefore lower LTA) values the touch threshold will be lower and vice versa. Changing the target counts of the touch channels, will also change the value of the LTA, which affect the counts required for a touch event. The Touch Threshold for CH0 & CH2 is set in Bank 0, while the Touch Threshold for CH1 is set in Bank 1 (when in full ATI-mode). This enables the designer to set the blocking channel's touch threshold independently from the other two channels, when not using the Partial ATI feature.

7.4 Proximity Threshold

The IQS232 has 4 proximity threshold settings. The proximity threshold is selected by the designer to obtain the desired sensitivity and noise immunity. The proximity event is triggered based on the selected proximity threshold; the CS and LTA (Long Term Average). The threshold is expressed in terms of counts; the same as CS. For a proximity event, the CS (counts) of the prox channel should fall the P_{THR} value below the LTA for at least 6 consecutive samples.



7.5 Halt time

The Halt Timer is started when a proximity or touch event occurs and is restarted when an event is removed or reoccurs. When a proximity condition occurs on any of the channels, the LTA for that channel will be "halted", thus its value will be kept fixed, until the proximity event is cleared, or the halt timer reaches the halt time. The Halt timer will count to the selected Halt time (t_{HALT}). If the timer expires, all outputs will be cleared. It is possible that the CS could be outside the ATI band (Target ± 160 or ± 80) when the timer expires, which will cause a re-ATI event. The designer needs to select a Halt Timer value to best accommodate the required application.

20 seconds The halt timer will halt for 20 seconds after the last proximity or touch event.

40 seconds The halt timer will halt for 40 seconds after the last proximity or touch event.

Never With the Never Halt option, the filter will not halt when any proximity or touch condition occurs. This means the LTA will follow the CS and an event will clear when LTA reaches below the CS + threshold value.

Always With the 'ALWAYS' option, the detection of a proximity event will halt the LTA for only 40 seconds and with the detection of a touch event will halt the LTA for as long as the touch condition applies.

7.6 Proximity Base Value

The IQS232 has the option to change the Base Value of the distributed Proximity channel during the ATI algorithm. Depending on the application, this provides the user with another op-

tion to select the sensitivity of the proximity detection without changes in the hardware (CX sizes and routing, etc). There are 4 available options, with another 4 options becoming available when the BASESEL bit is set to alternative.

7.7 Sensitivity Multipliers

Sensitivity multipliers are added after the base value is selected through the base multipliers. If the sensitivity multipliers are selected high, the ATI algorithm could reach the target counts without adding any compensation, thus rendering the device less sensitive. For the same reasoning, setting the sensitivity multipliers low, will add more compensation, and increase the device sensitivity.

7.8 Base Multipliers

Base multipliers selects the base value of the ATI algorithm. Thus, if lower values are selected, the algorithm needs to add more sensitivity multipliers and compensation to reach the target counts, rendering the device more sensitive. For the same reasoning, the device will be less sensitive when using higher base multipliers. Care should be taken when setting the base multipliers low, as setting them to low, could cause the algorithm not to reach the target. Not reaching the target impact the touch thresholds, as the are derived from the LTA.

7.9 Base Select

The Base Select bit, changes the values of the proximity channel's base value options. This allows for a different range of available options, as illustrated in Table 7.9.



Table 7.1: Distributed proximity channel's base values.

Base Select		
0	1	
200	150	Base1:Base0
50	350	
100	500	
250	700	

7.10 Charge Transfer Frequency

The IQS232 has two available for the charge transfer frequency. The default (512kHz) is more sensitive, while the 1MHz option allows for better immunity against false detection in applications where moisture could be present near the sense electrodes. The faster frequency is recommended for better stability and response rate in applications with very thin overlays.

7.11 Streaming mode

There is a streaming bit available that allows for serial data communication on the IQS232. Streaming is done via an I²CTM compatible 3-wire interface, which consist of a data (SDA), clock (SCL) and ready (RDY) line. The IQS232 can only function as a slave on the bus, and will only acknowledge on address 0x44H. The RDY line is to be used by the host controller as an indication of when to start communication to the device. The RDY line will be low when it is ready for communication, and it will high when it is doing conversions. The IQS232 will not ack on its address while the RDY line is high (thus while the IQS232 is doing conversions).

7.12 Noise Detect

The IQS232 has advanced immunity to RF noise sources such as GSM cellular telephones, DECT, Bluetooth and WIFI devices.

Design guidelines should however be followed to ensure the best noise immunity. Notes for layout:

- ❑ A ground plane should be placed under the IC, except under the Cx lines
- ❑ Place the sensor IC as close as possible to the sense electrodes.
- ❑ All the tracks on the PCB must be kept as short as possible.
- ❑ The capacitor between VDDHI and GND as well as between VREG and GND must be placed as close as possible to the IC.
- ❑ A 100 pF capacitor can be placed in parallel with the 1uF capacitor between VDDHI and GND. Another 100 pF capacitor can be placed in parallel with the 1uF capacitor between VREG and GND.
- ❑ When the device is too sensitive for a specific application a parasitic capacitor (max 5pF) can be added between the CX line and ground.
- ❑ Proper sense electrode and button design principles must be followed.
- ❑ Unintentional coupling of sense electrode to ground and other circuitry must be limited by increasing the distance to these sources.
- ❑ In some instances a ground plane some distance from the device and sense electrode may provide significant shielding from undesirable interference.

However, if interference from RF noise sources persist after proper layout, see [2], the IQS232 has a noise detect function which will detect RF noise and block outputs from the device. Different antenna layouts can be used on the RF detect pin (pin 6) and more details can be found in [2].



7.13 Low Power Mode

The IQS232 IC has four power modes specifically designed to reduce current consumption for battery applications. The power modes are implemented around the occurrence of charge cycle every t_{SAMPLE} seconds (refer to Table 7.2). Lower sampling frequencies yield lower power consumption (but decreased response time). During normal operation charge cycles are initiated approximately every 50ms. This is referred to as Normal Power Mode (NP). The IQS232 by default charges in Boost Power Mode. The timings for all the Power Modes are provided in the table below. While in any power mode the device will zoom to BP whenever a sampled count indicates a possible proximity or touch event. This improves the response time. The device will remain in BP for t_{ZOOM} seconds and then return to the selected power mode. The Zoom function allows reliable detection of events with counts being produced at the BP rate.

Table 7.2: IQS232 Low Power Mode Timings

Power Mode	t_{SAMPLE} (ms)
t_{BP} (default)	9
t_{NP}	32
t_{LP1}	128
t_{LP2}	1000



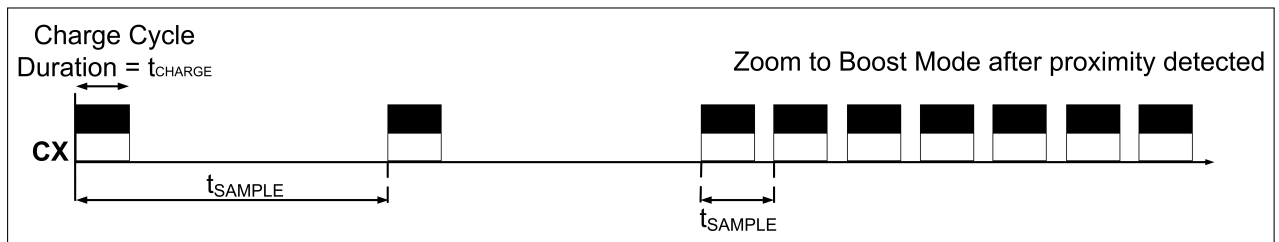

Figure 7.1: LP Modes: Charge cycles.

7.14 Guard Channel

When the guard channel (or blocking channel) is enabled, the other touch outputs from the device are blocked when a touch condition is detected on CH1 (CH1's touch output is still active). This can prevent accidental activation when picking up a product, or give a blocking function against water or other environmental factors.

and 250 for the touch channels.

7.15 Output Logic Select

The IQS232 can be set to sink or source current in stand-alone mode, by setting the logic output active high or active low. For characterisation data, please refer to Table 10.3.

7.16 ATI Delay

The IQS232 allows an ATI delay option of 0 seconds (immediately) or 10 seconds after the Proximity output is cleared (and the counts are not within the allowed ATI band).

7.17 ATI Target

The default target counts of the IQS232 are 1000 for the proximity channel, and 500 for the touch channels. However, for some application, a less sensitive and lower target is acceptable, which will also increase the response rate. Therefore, the ATI Target bit can be set, changing the targets to 500 for the proximity channel,





8 Charge Transfers

The IQS232 samples in 3 time slots, with one internal C_S capacitor. The charge sequence is shown in 8.1, where CH0 is the Proximity channel, and charges before each of the 2 touch channels. The proximity channel is realised by connecting both sense electrodes with internal switches. Therefore: CH0 is a distributed electrode formed by the 2 touch electrodes.

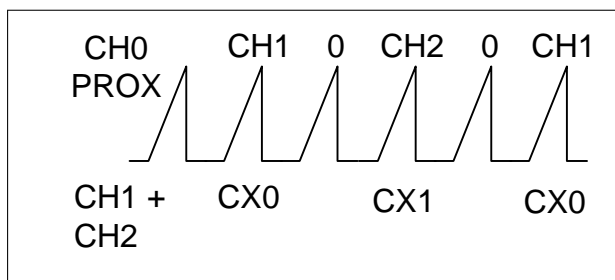

Figure 8.1: Charge Transfer for IQS232.





9 Auto Tuning Implementation

ATI is a sophisticated technology implemented in all but the first generation ProxSense® devices that optimises the performance of the sensor in a wide range of applications and environmental conditions refer to application note [7], AZD027 - Auto Tuning Implementation. ATI makes adjustments through internal reference capacitors to obtain optimum performance. ATI adjusts internal circuitry according to two parameters, the ATI multipliers and the ATI compensation. The ATI multiplier can be viewed as a course adjustment and the ATI compensation as a fine adjustment. The adjustment of the ATI parameters will result in variations in the counts and sensitivity. Sensitivity can be observed as the change in counts as the result of a fixed change in sensed capacitance. The ATI parameters have been chosen to provide significant overlap. It may therefore be possible to select various combinations of ATI multiplier and ATI compensation settings to obtain the same counts. The sensitivity of the various options may however be different for the same counts.

9.1 Full ATI

The IQS232 implements an automatic ATI algorithm. This algorithm automatically adjusts the ATI parameters to optimise the sense electrodes connection to the device. The device will execute the ATI algorithm whenever the device starts-up and when the counts are not within a predetermined range. While the Automatic ATI algorithm is in progress this condition will be indicated in the streaming data and proximity and touch events cannot be detected. The device will only briefly remain in this condition and it will be entered only when relatively large shifts in the counts has been detected. The automatic ATI function aims to keep the counts constant, regardless of the capacitance of the sense elec-

trode (within the maximum range of the device). The effects of auto-ATI on the application are the following:

- ❑ Automatic adjustment of the device configuration and processing parameters for a wide range of PCB and application designs to maintain an optimal configuration for proximity and touch detection.
- ❑ Automatic tuning of the sense electrodes at start-up to optimise the sensitivity of the application.
- ❑ Automatic re-tuning when the device detects changes in the sensing electrodes capacitance to accommodate a large range of changes in the environment of the application that influences the sense electrodes.
- ❑ Re-tuning only occurs during device operation when a relatively large sensitivity reduction is detected. This is to ensure smooth operation of the device during operation.
- ❑ Re-tuning may temporarily influences the normal functioning of the device, but in most instances the effect will be hardly noticeable.
- ❑ Shortly after the completion of the re-tuning process the sensitivity of Proximity detection may be reduced slightly for a few seconds as internal filters stabilises. Automatic ATI can be implemented so effectively due to:
 - ❑ Excellent system signal to noise ratio (SNR).
 - ❑ Effective digital signal processing to remove AC and other noise.
 - ❑ The very stable core of the devices.
 - ❑ The built in capability to accommodate a large range of sense electrodes capacitance.



9.2 Partial ATI

If the ATI Select bit is set to Partial ATI, the touch threshold for CH2 is the same as for CH1 (see Section 7.1, CH2's touch threshold is now also set in Bank 0). If the ATI bit is not set (default), CH2 has its own touch threshold. The same applies to the Proximity channel's base value, which is not set in the first two bits of Bank 1 anymore. Instead, the first 5 bits of Bank 1, changes to Multiplier bits (both Sensitivity and Compensation). Setting the partial ATI bit is useful for production devices (after prototyping has revealed the correct setup) as it decreases the start-up time of the IC, since the full ATI algorithm is not implemented at from a cold-start.





10 Specifications

Absolute Maximum Specifications

The following absolute maximum parameters are specified for the device: Exceeding these maximum specifications may cause damage to the device.

<input type="checkbox"/>	Operating temperature	-40 °C to +85 °C
<input type="checkbox"/>	Supply Voltage (VDDHI - GND)	3.6 V
<input type="checkbox"/>	Maximum pin voltage	VDDHI + 0.5 V
<input type="checkbox"/>	Maximum continuous current (for specific Pins)	2 mA
<input type="checkbox"/>	Minimum pin voltage	GND - 0.5 V
<input type="checkbox"/>	Minimum power-on slope	100 V /s
<input type="checkbox"/>	ESD protection	±4 kV
<input type="checkbox"/>	Moisture Sensitivity Level	MSL 3

Table 10.1: IQS232 General Operating Conditions

Description	Condition	Parameter	MIN	TYP	MAX	Unit
Supply voltage		VDDHI	1.8		3.6	V
Internal regulator output	$1.8 \leq VDDHI \leq 3.3$	VREG	1.62	1.7	1.79	V
Boost operating current	$1.8 \leq VDDHI \leq 3.3$	$I_{IQS232BP}$		148		μA
Normal operating current	$1.8 \leq VDDHI \leq 3.3$	$I_{IQS232NP}$		80		μA
Low power operating current	$1.8 \leq VDDHI \leq 3.3$	$I_{IQS232LP1}$		18		μA
Low power operating current	$1.8 \leq VDDHI \leq 3.3$	$I_{IQS232LP2}$		3.5		μA

Table 10.2: Start-up and shut-down slope Characteristics

Description	Condition	Parameter	MIN	MAX	Unit
POR	VDDHI Slope ≥ 100 V/s	POR	1.2	1.6	V
BOD		BOD	1.15	1.55	V

Table 10.3: POUT and TOUT Characteristics for each I/O

Symbol	Description	Conditions	I_{SOURCE}	UNIT
VOH	Output High voltage	VDDHI = 3.3V	5	mA
Symbol	Description	Conditions	I_{SINK}	UNIT
VOL	Output Low voltage	VDDHI = 3.3V	10	mA





Table 10.4: Initial Touch Times

Description	Parameter	MIN	MAX	Unit
BP	Report Rate	20	61	ms
NP	Report Rate	63	120	ms
LP1	Report Rate	63	216	ms
LP2	Report Rate	63	1088	ms

Table 10.5: Repetitive Touch Rates

DESCRIPTION	Sample rate	Response Rate	UNIT
All power modes	5ms	> 15	Touches/second
All power modes	9ms	> 8	Touches/second



11 Mechanical Dimensions

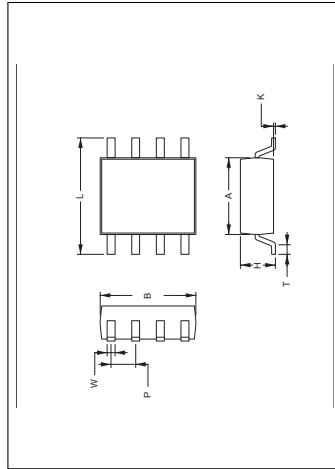

Figure 11.1: SO 8 Package.

Table 11.1: SO-8 Package Dimensions.

Dimension	[mm]
A_{min}	3.75
A_{max}	4.15
B_{min}	4.73
B_{max}	5.13
H_{max}	1.80
L_{min}	5.70
L_{max}	6.30
T_{min}	0.30
T_{max}	0.70
Pitch	1.27
W_{min}	0.31
W_{max}	0.51



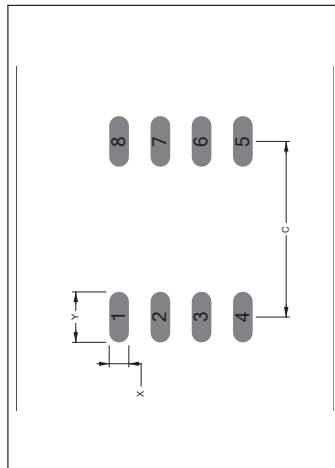

Figure 11.2: SO 8 Footprint.

Table 11.2: SO 8 Footprint Dimensions

Dimension	mm
Pitch	1.27
C	5.40
Y	1.55
X	0.60

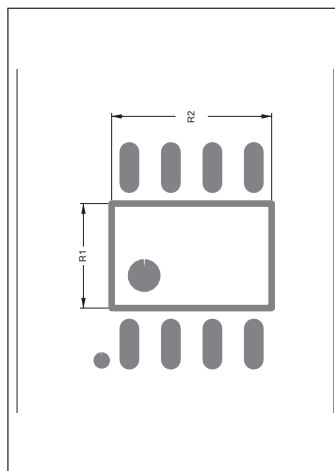

Figure 11.3: SO 8 Silk Screen.





Table 11.3: SO-8 Silk Screen Dimensions

Dimension	mm
R1	3.20
R2	4.90





12 Device Marking

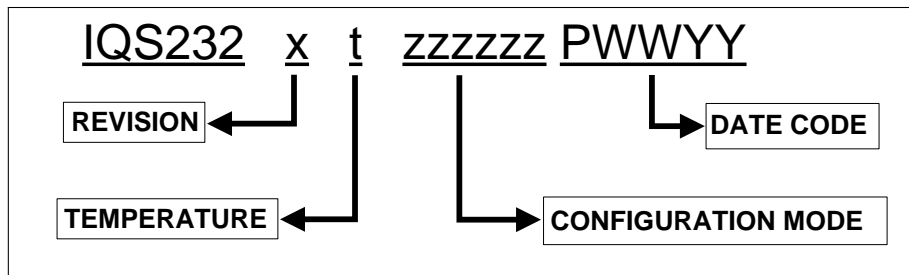

REVISION	x	=	IC Revision Number
TEMPERATURE RANGE	t	=	I -40 °C to 85 °C (Industrial) C 0 °C to 70 °C (Commercial)
IC CONFIGURATION	zzzzzz	=	Configuration (Hexadecimal)
DATE CODE	P	=	Package House
	WW	=	WEEK
	YY	=	YEAR

13 Ordering Information

Orders will be subject to a MOQ (Minimum Order Quantity) of a full reel. Contact the official distributor for sample quantities. A list of the distributors can be found under the "Distributors" section of www.azoteq.com. For large orders, Azoteq can provide pre-configured devices. The Part-number can be generated by using USBProg.exe or the Interactive Part Number generator on the website.

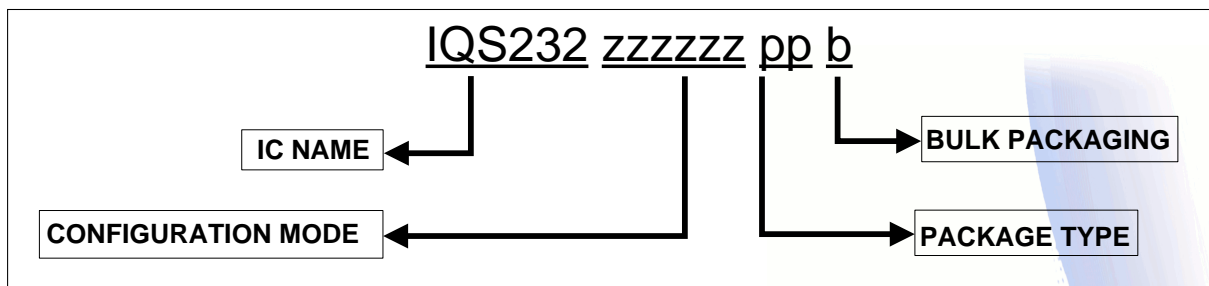

IC NAME	IQS232	=	IQS232
CONFIGURATION	zzzzzz	=	IC Configuration (hexadecimal)
PACKAGE TYPE	SO	=	SO-8
BULK PACKAGING	R	=	Reel (4000pcs/reel) - MOQ = 4000pcs





14 Contact Information

PRETORIA OFFICE
Physical Address
160 Witch Hazel Avenue
Hazel Court 1, 1st Floor
Highveld Techno Park
Centurion, Gauteng
Republic of South Africa
Tel: +27 12 665 2880
Fax: +27 12 665 2883
Postal Address
PO Box 16767
Lyttelton
0140
Republic of South Africa

PAARL OFFICE
Physical Address
109 Main Street
Paarl
7646
Western Cape
Republic of South Africa
Tel: +27 21 863 0033
Fax: +27 21 863 1512
Postal Address
PO Box 3534
Paarl
7620
Republic of South Africa

The following patents relate to the device or usage of the device: US 6,249,089 B1, US 6,621,225 B2, US 6,650,066 B2, US 6,952,084 B2, US 6,984,900 B1, US 7,084,526 B2, US 7,084,531 B2, US 7,119,459 B2, US 7,265,494 B2, US 7,291,940 B2, US 7,329,970 B2, US 7,336,037 B2, US 7,443,101 B2, US 7,466,040 B2, US 7,498,749 B2, US 7,528,508 B2, US 7,755,219 B2, US 7,772,781, US 7,781,980 B2, US 7,915,765 B2, EP 1 120 018 B1, EP 1 206 168 B1, EP 1 308 913 B1, EP 1 530 178 B1, ZL 99 8 14357.X, AUS 761094

IQ Switch®, ProxSense®, LightSense™, AirButton® and the  logo are trademarks of Azoteq.

The information in this Datasheet is believed to be accurate at the time of publication. Azoteq assumes no liability arising from the use of the information or the product. The applications mentioned herein are used solely for the purpose of illustration and Azoteq makes no warranty or representation that such applications will be suitable without further modification, nor recommends the use of its products for application that may present a risk to human life due to malfunction or otherwise. Azoteq products are not authorised for use as critical components in life support devices or systems. No licenses to patents are granted, implicitly or otherwise, under any intellectual property rights. Azoteq reserves the right to alter its products without prior notification. For the most up-to-date information, please refer to www.azoteq.com.



15 Memory Map

		Product Number								R/W
00H	Bit	7	6	5	4	3	2	1	0	
		Product Number								
	Default	0x1F								R

		Version Number								R/W
01H	Bit	7	6	5	4	3	2	1	0	
		Version Number								
	Default	0x09								R

		System Flags						R/W		
10H	Bit	7	6	5	4	3	2	1	0	
		System Use		LP	ATI Busy	ND	Zoom			
	Default				0	0	0			R

		Proximity Channels							R/W	
31H	Bit	7	6	5	4	3	2	1	0	
							CH2	CH1	CH0	
	Default						0	0	0	R

		Touch Channels							R/W	
35H	Bit	7	6	5	4	3	2	1	0	
							CH2	CH1	CH0	
	Default						0	0	0	R





	System Use								R/W
Bit	7	6	5	4	3	2	1	0	
36H									
Default	0								R

	System Use								R/W
Bit	7	6	5	4	3	2	1	0	
37H									
Default	0								R

	Filter Halt								R/W
Bit	7	6	5	4	3	2	1	0	
39H						CH2	CH1	CH0	
Default						0	0	0	R

	Channel Number								R/W
Bit	7	6	5	4	3	2	1	0	
3DH									
Default	Current Channel								R

	Current Sample (CS)								R/W
Bit	7	6	5	4	3	2	1	0	
42H	High Byte								
Default									R

	Counts (CS)								R/W
Bit	7	6	5	4	3	2	1	0	
43H	Low Byte								
Default									R





	Long Term Average (LTA)								R/W	
83H	Bit	7	6	5	4	3	2	1	0	
		High Byte								
	Default									R

	Long Term Average (LTA)								R/W	
84H	Bit	7	6	5	4	3	2	1	0	
		Low Byte								
	Default									R

	OTP Bank 0								R/W	
C4H	Bit	7	6	5	4	3	2	1	0	
		Details in Table \ref								
	Default									R/W

	OTP Bank 1								R/W	
C5H	Bit	7	6	5	4	3	2	1	0	
		Details in Table \ref								
	Default									R/W

	OTP Bank 2								R/W	
C6H	Bit	7	6	5	4	3	2	1	0	
		Details in Table \ref								
	Default									R/W

	OTP Bank 3								R/W	
C7H	Bit	7	6	5	4	3	2	1	0	
		Details in Table \ref								
	Default									R/W

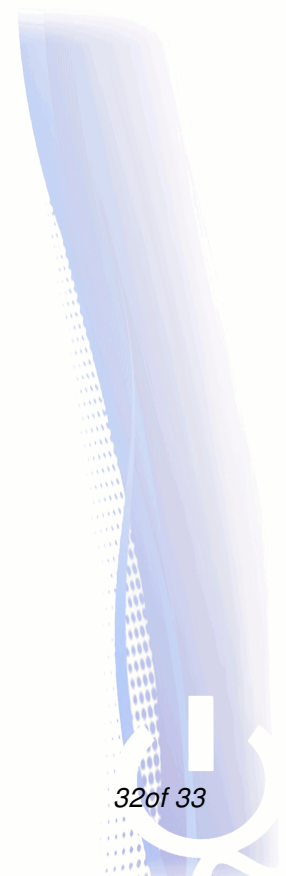



References

- [1] *AZD013 - Calculating Rx for improving ESD ratings.* Azoteq, 2008.
- [2] *AZD015 - RF Immunity Guidelines.* Azoteq, 2011.
- [3] *AZD051 - Electrical Fast Transient Burst Guidelines.* Azoteq, 2011.
- [4] *AZD052 - Conducted RF Immunity Guidelines.* Azoteq, 2011.
- [5] *AZD008 - Design Guidelines for Touch Pads.* Azoteq, 2011.
- [6] *AZD007 - USB Prog Overview.* Azoteq, 2008.
- [7] *AZD027 - Auto Tuning Implementation.* Azoteq, 2009.



Mouser Electronics

Authorized Distributor

Click to View Pricing, Inventory, Delivery & Lifecycle Information:

[Azoteq:](#)

[IQS232-00000SOR](#)