



ADM8628

802.11b Access Point/Home Gateway

Product Overview

[ADMtek.com.tw](http://www.ADMtek.com.tw)

Information in this document is provided in connection with ADMtek products. ADMtek may make changes to specifications and product descriptions at any time, without notice. Designers must not rely on the absence or characteristics of any features or instructions marked "reserved" or "undefined". ADMtek reserves these for future definition and shall have no responsibility whatsoever for conflicts or incompatibilities arising from future changes to them

The products may contain design defects or errors know as errata, which may cause the product to deviate from published specifications. Current characterized errata are available on request. To obtain latest documentation please contact you local ADMtek sales office or visit ADMtek's website at <http://www.ADMtek.com.tw>

*Third-party brands and names are the property of their respective owners.

About this Manual

Structure

This Data sheet contains 3 chapters

Chapter 1 Product Overview

Chapter 2 Pin Diagram

Chapter 3 Function Description

Customer Support

ADMtek Incorporated,
2F, No.2, Li-Hsin Rd.,
Science-based Industrial Park,
Hsinchu, 300, Taiwan, R.O.C.

Sales Information

Tel + 886-3-5788879
Fax + 886-3-5788871

DataSheet4U.com

et4U.com

DataShee

1. Product Overview

1.1 Overview

The ADM8628 Access Point is an ARM7TDMI-based networking device that bridges the Wireless LAN and the Fast Ethernet.

The ADM8628 implements the IEEE 802.11b Wireless LAN MAC AP mode protocol, the IEEE 802.3 Fast Ethernet protocol and PHY layer, and bridging function. For the enhanced security specified in IEEE 802.11i, the AES engine with several operation modes (AES-OCB-128, AES-CBC and AES-CNT) are provided. WEP, TKIP hardware engines are also provided to parse packets, executing the encryption and decryption process automatically when key is hit in key table without bothering CPU. There are four shared keys and 64 individual keys stored in the ASIC. More keys can be supported in software level as a superset of ASIC keys. The ADM8628 also reserves the Wireless LAN MAC station mode to make itself as a pure bridging device from LAN to wireless LAN to be Media Converter.

Different configurations of FLASH, SDRAM and SRAM devices are allowed for different applications. The cache controller supports flexible policy to optimize performance and minimize CPU bus traffic.

The MII interface is supported for customers' applications. This interface can be also set to reversed-MII to connect switch's MII interface for more LAN ports' applications.

ADM8628 could be treated as a network processor to cooperate with some external devices via SRAM interface.

DataSheet4U.com

et4U.com

DataShee

1.2 Features

Architecture Features

- Bridging core: ARM7TDMI with 8KB cache
- 3 DMA engines for direct memory access
 - 1 Wired 10/100 MAC with DSP PHY.
 - 1 wired 10/100 MAC with MII / reversed MII interface.
 - 1 802.11b Wireless MAC.
- UART for software debugging and modem interface
- Flexible external memory support:
 - FLASH of up to 16MB
 - SDRAM of up to 512MB
 - SRAM of up to 8MB
- Standards compliant:
 - IEEE 802.11b High Rate
 - IEEE 802.11d
 - IEEE 802.11i / D3
 - IEEE 802.3
- LEDs:
 - LED1 (pin 57) on: power on / flash: flash booting
 - LED2 (pin 58) on: associated / flash: radio traffic
 - LED3 (pin 32) for LAN1 3A mode on: link / flash: activity
 - LED4 (pin 34) for LAN1 3A mode on: 100M / off: 10M
 - LED5 (pin 35) for LAN1 on: full duplex / flash traffic is detected
- Packaging: 208PQFP

ARM Core Features

- CPU clock: 75MHZ
- CPU: AHB: MPMC ratio: (75MHZ: 75MHZ: 75MHZ)
- AHB devices: WLAN, LAN1, LAN2, ARM7TDMI, MPMC, TIC
- APB devices: UART, watchdog timer
- Power management: Processor suspend, system bus suspend
- TIC (Test Interface Control): Support manufacturing tests
- Debugging interface: JTAG for ARM-multiICE, trace32
- Interrupts: FIQ (fast), IRQ (for general interrupts)

Security Related Features

- KEY number:

- 4 Shared KEY / 64 individual KEY shored in ASIC for full WEP/TKIP support
- Software expandability: up to 128 keys can be maintained in software level, depending on different software implementation
- Pre-RSN:
 - Authentication / Encryption: RSA RC-4 with key length of either 40 or 104 bits WEP.
- 802.11i - RSN (Robust Security Network):
 - *TKIP* hardware fully supports 802.11i/D3
 - *AES / AES-OCB-128 / AES-CNT / AES-CBC* engine to offload CPU
 - Beacon / probe response supports RSN information element
 - *TKIP* 48bit *Sequence Counter* supports for each MPDU for anti-replay purpose

802.11d Multi-regulatory

- Beacon / probe response supports CI (Country Information)

Software Features

- Security: 802.1X support /EAP-TLS
- Standards: *SNMP v2*
- Roaming:
 - *DHCP*
 - *IAPP* (802.11f/r3)
- Manageability: Configure, monitor, and manage using WEB browser anywhere. Local configuration also provided
- Client Access Control via
 - MAC address
 - 802.11 Authentication (*Pre-RSN*)
 - 802.1X Authentication (*RSN*)
 - *SSID*
- Embedded HTTP server
- *SNMPv2* traps for MIB access, *SNMP* alarm
- Web-firmware upgradeable, telnet, BOOTP, TFTP
- RS232C, Web-configurable

1.3 ADM8628 Chip Architecture

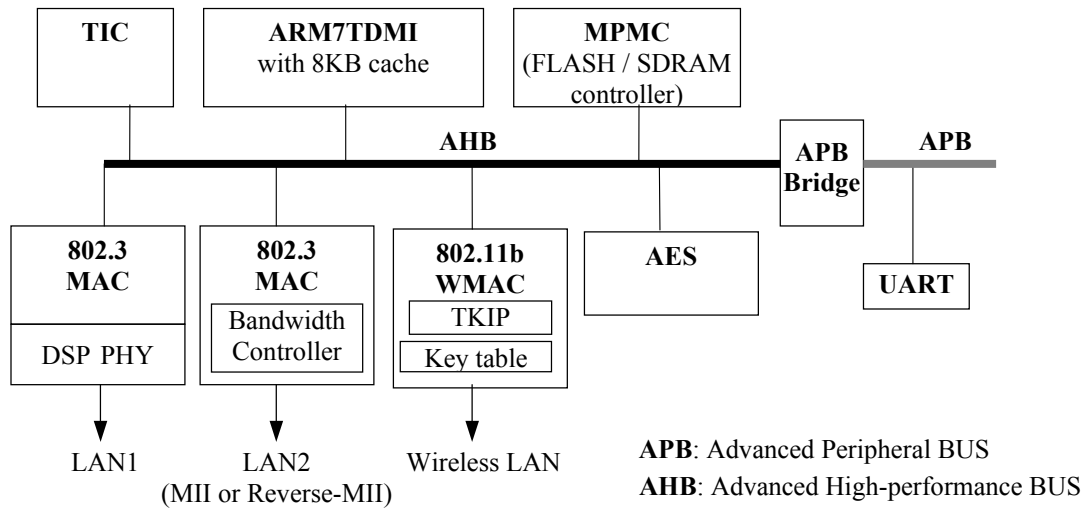

Figure 1-1 ADM8628 Chip Architecture

1.4 Software Block Diagram

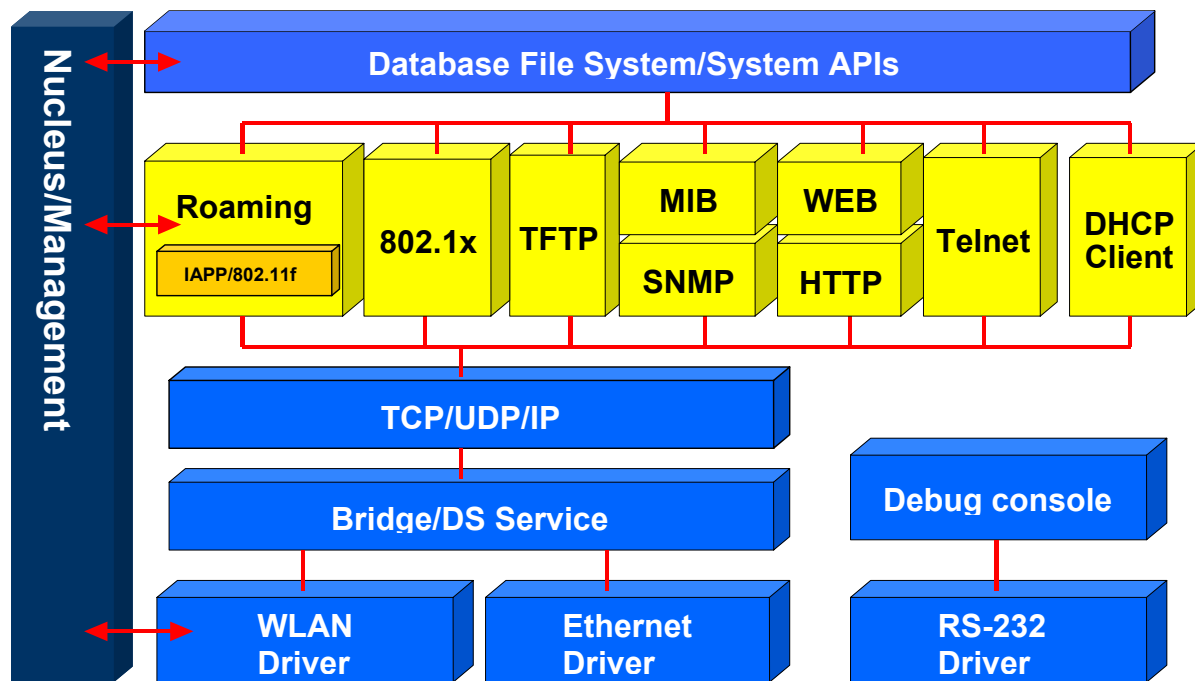

Figure 1-2 Software Block Diagram

2. Pin Diagram

2.1 ADM8628 Pin Diagram

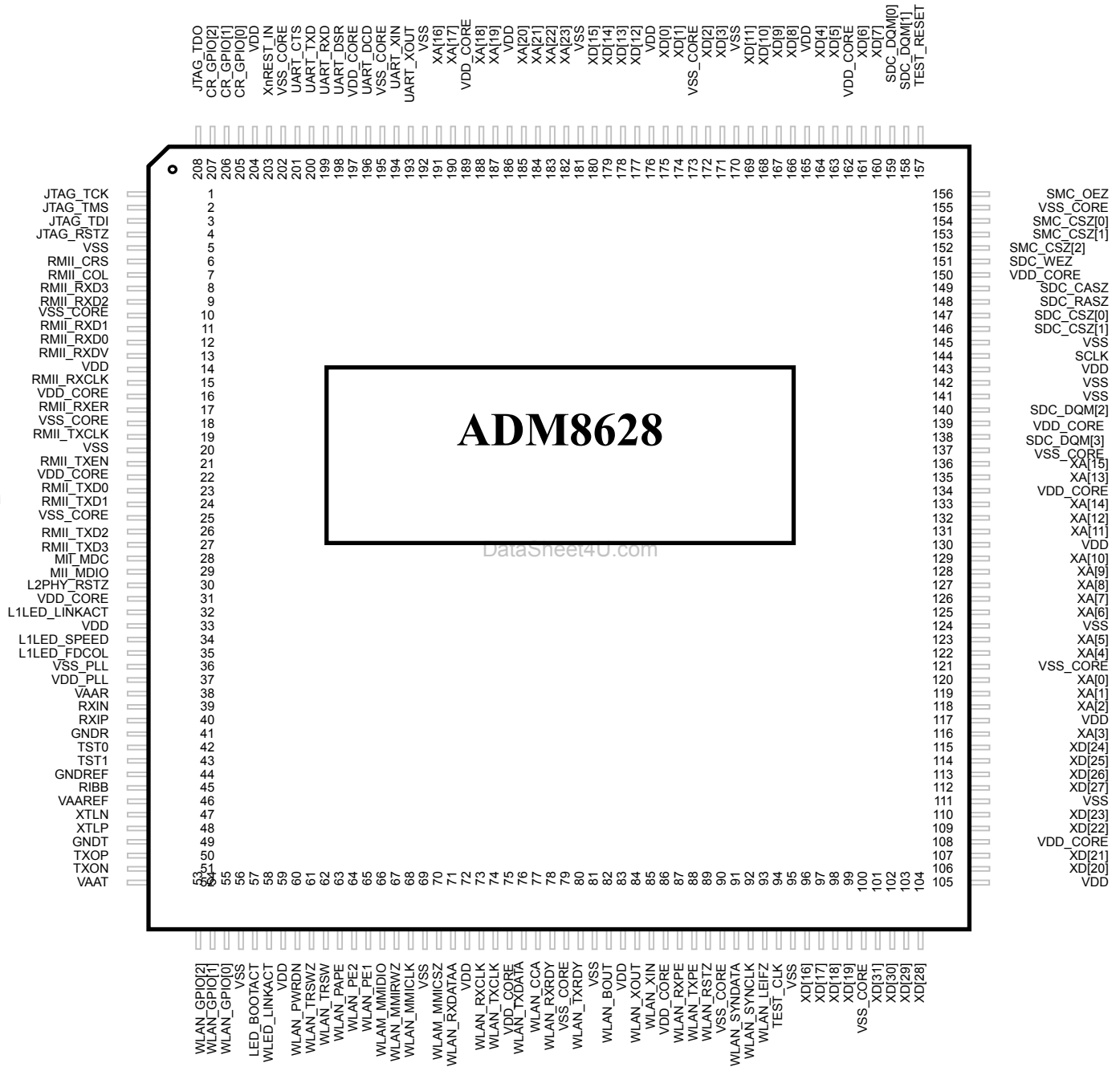

Figure 2-1 ADM8628 Pin Diagram

3. Function Description

3.1 Device Functional Block Overview

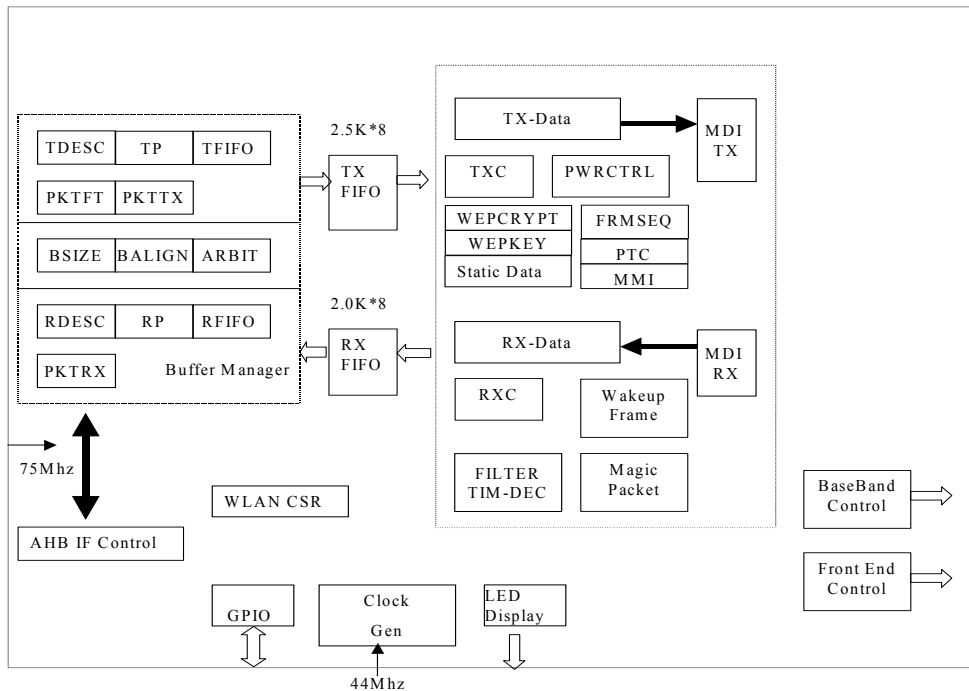

Figure 3-1 Device Functional Blocks

3.2 Applications

Note:

Red line means wireless channel, black line means wired channel.

3.2.1 Access Point

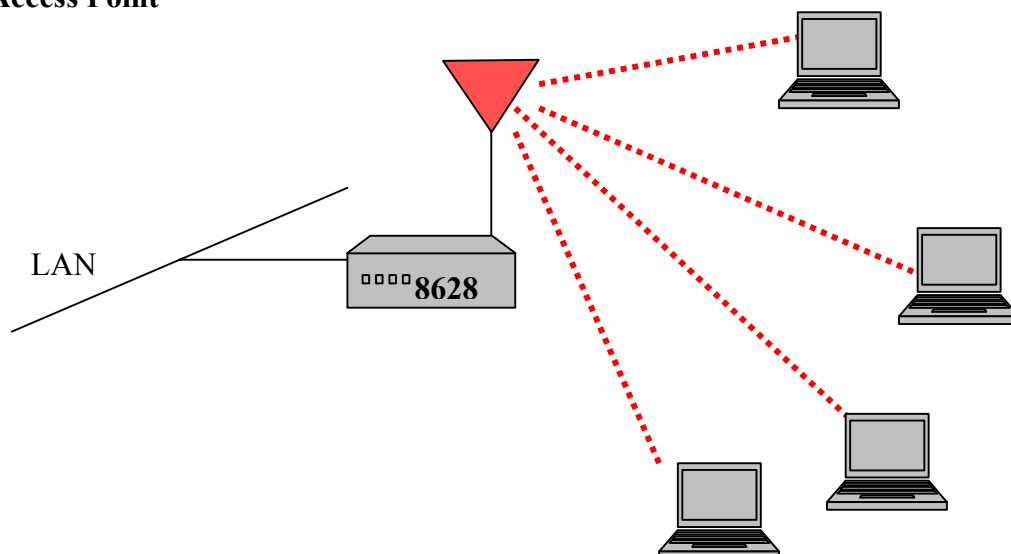

3.2.2 Media Converter / Ethernet to Wireless Dongle

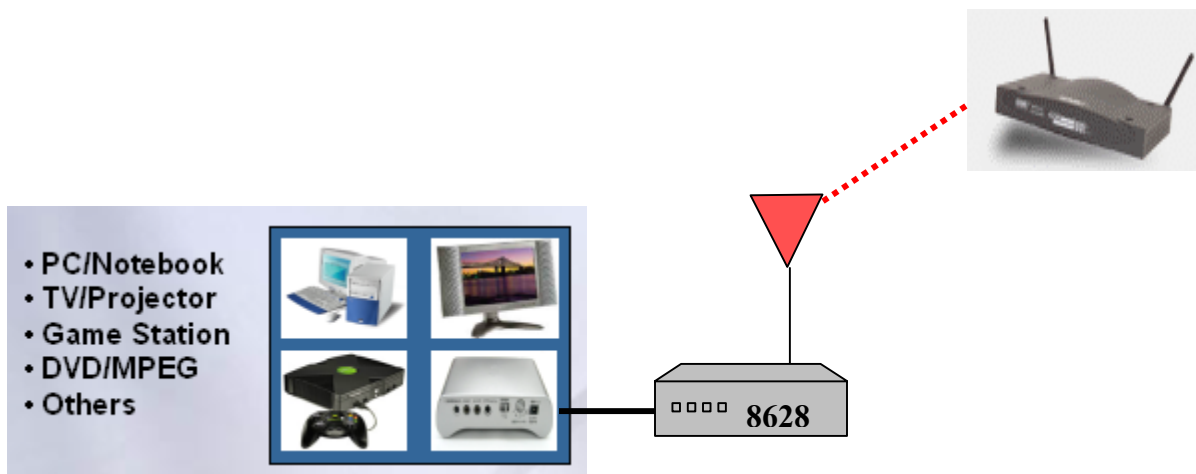

3.2.3 Home gateway

Connecting with multi-port switch IC, like 5-port switch ADM6996, via reversed MII to be multi-port Home Gateway.

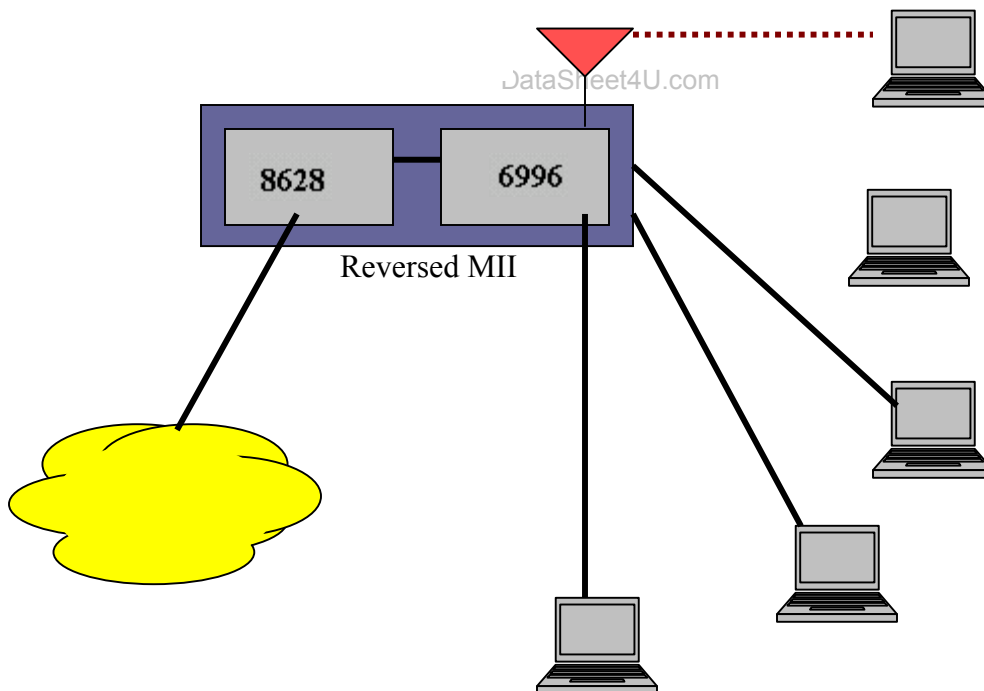

3.2.4 Personal Gateway

Connecting with external PHY via reversed MII to be 1LAN+1WAN+1Wireless Personal Gateway.



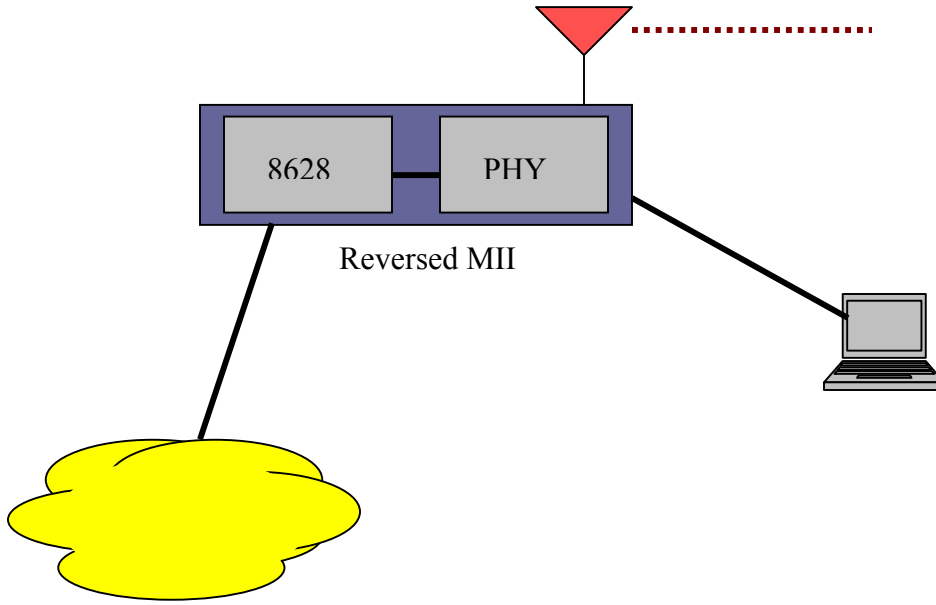

et4U.com

DataSheet4U.com